

X.R. SANAKULOV, D.P. XODIYEVA, A.R. SANAKULOVA

MEHNAT TA'LIMI

Umumiy o'рта ta'lim maktablarining
3-sinfi uchun darslik

*O'zbekiston Respublikasi Xalq ta'limi
vazirligi tasdiqlagan*



«SHARQ» NASHRIYOT-MATBAA
AKSIYADORLIK KOMPAANIYASI
BOSH TAHRIRIYATI
TOSHKENT – 2016

UO'K: 372.831(075)
KBK 74.263
S-30

Shartli belgilar:



– topshiriq



– savol



– eslatma



– kasblar haqida ma'lumot



– uyda bajaring

S-30 **Sanakulov, X.** va boshq.

Mehnat ta'limi: 3-sinf uchun darslik / X.R. Sanakulov,
D.P. Xodiyeva, A.R. Sanakulova. – T.: «Sharq», 2016. –
80 b.

I. 1,2. Muallifdosh.

ISBN 978-9943-26-495-3

UO'K: 372.831(075)
KBK 74.263

**Respublika maqsadli kitob jamg'armasi mablag'lari
hisobidan chop etildi.**

ISBN 978-9943-26-495-3

© X. Sanakulov, D. Xodiyeva, A. Sanakulova, 2016.
© «SHARQ» NMAK Bosh tahririyati, 2016.

KIRISH

Aziz o'quvchilar!

Siz 2-sinf «Mehnat ta'limi» darsida qo'l mehnati bilan bajariladigan ish namunalari o'rganish bilan birga mehnat anjomlaridan to'g'ri foydalanish, xavfsizlik qoidalariga rioya qilishni o'rgandingiz. Amaliy ishni bajarish bilan birga o'z mehnatingiz natijasidan zavqlandingiz.

Endi siz 3-sinfda qog'oz, karton, har xil tabiiy materiallardan bajarilishi murakkab, ko'p bosqichli bo'lgan turli shakllarni yasash-qurishni, bezakli o'yinchoqlar, maket va modellarni yasashni o'rganasiz.

Ushbu darslik sahifalarida berilgan ish namunalarini chiroyli va sifatli bajarishda o'qituvchingiz maslahati, ota-onangiz ko'magi va o'z ijodiy bilimlaringizga suyanmog'ingiz kerak.

Aziz o'quvchilar, darslikdan unumli foydalanib, topshiriq va mustaqil ishlarni to'g'ri bajarishga harakat qiling.

MEHNAT TA'LIMI DARSIDA BAJARILADIGAN ISHLARDAN NAMUNALAR





MEHNAT TA'LIMI DARSIDA FOYDALANILADIGAN ISH QUROLLARI



Yelim



Qalam



Qaychi



Kanselyariya pichog'i



Sirkul



Bigiz



Chizg'ich



Mo'yqalam

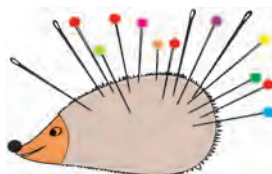

Igna



Ish qurollaridan foydalanishda mehnat xavfsizligi qoidalariga rioya qilishni unutmang.



Qaychidan to'g'ri foydalaning.

1. Qaychini maxsus g'ilofda, belgilangan joyda saqlang.



2. Qaychining uchini yuqoriga qaratib ushlamang.



3. Qaychini ishlatib bo'lgandan so'ng ochiq holda qoldirmang.



4. Qaychini yurib turganingizda ishlatmang.

5. Qaychini faqat yopilgan holda, uchidan ushlab boshqalarga uzating.



6. Qaychi bilan ishlayotganda, qirqa-yotgan buyum va qo'l harakatingizga diqqatni qarating.



7. Yaroqsiz qaychidan foydalanmang.



TABIY MATERIALLARDAN APPLIKATSIYA YASASH

SOMONDAN O'YINCHOQLAR YASASH



O'qituvchingiz tayyorlab bergan somonlarni qog'ozga yelimlab oling.

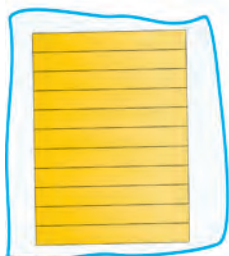

1



2



Mustaqil yasab ko'ring.

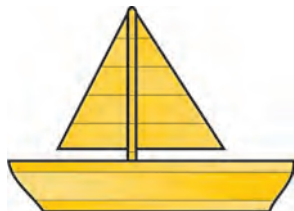

TABIY MATERIALLARDAN APPLIKATSIYALAR

!

Tabiiy materiallardan o'z o'rnida foydalaning.



?

Parrandalarning nomini bilasizmi?



Tabiiy materiallardan foydalanib, otangiz yordamida uy hayvonlarini yasab ko'ring.



QOG'OZDAN AYIQCHA YASASH

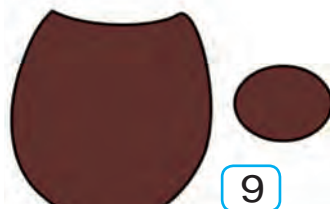

Har bir bosqichni ketma-ket, to'g'ri bajaring.



10

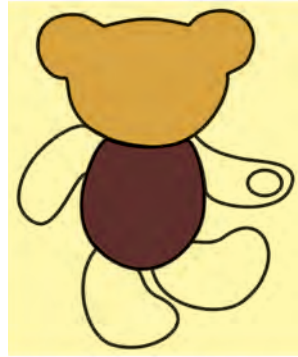

11

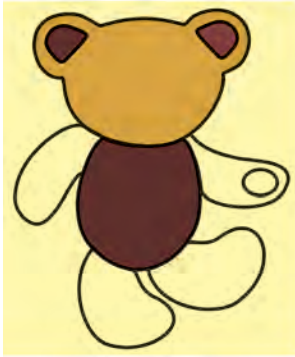

12



13



14



?

Yana qanday hayvonlarning nomini
aytib bera olasiz?



Mustaqil yasab ko'ring.

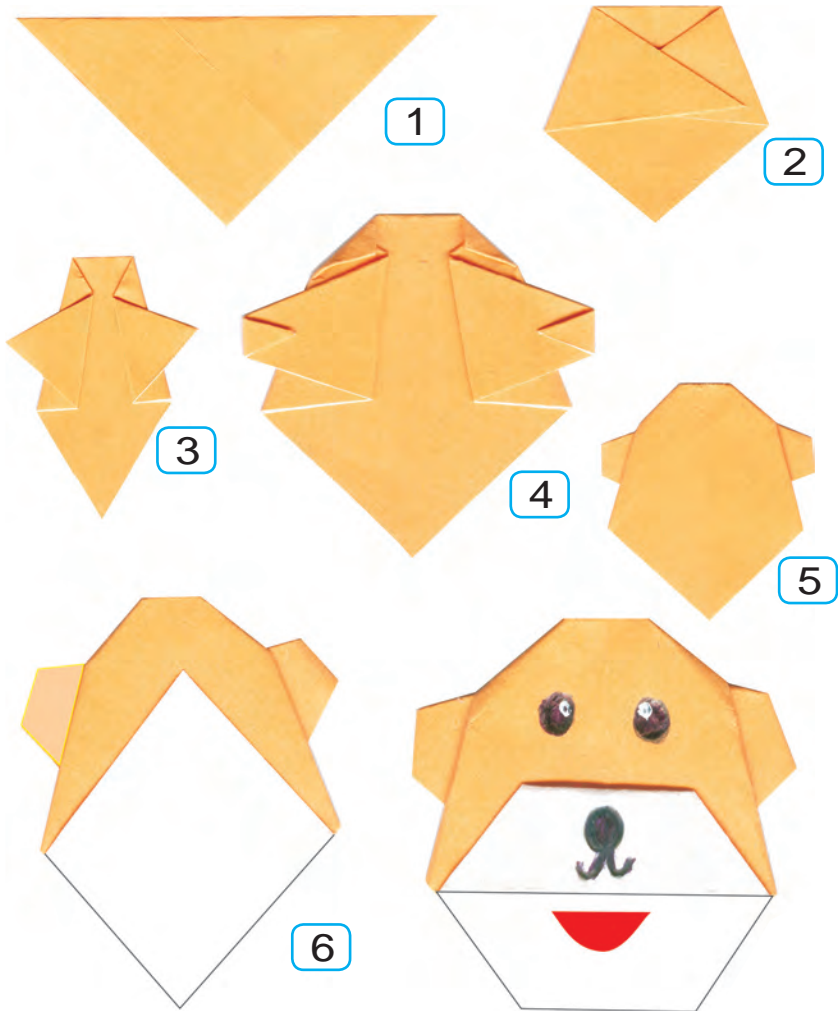

?

Itlar haqida nimalar bilasiz?



PLASTILINDAN IDISHLAR YASASH

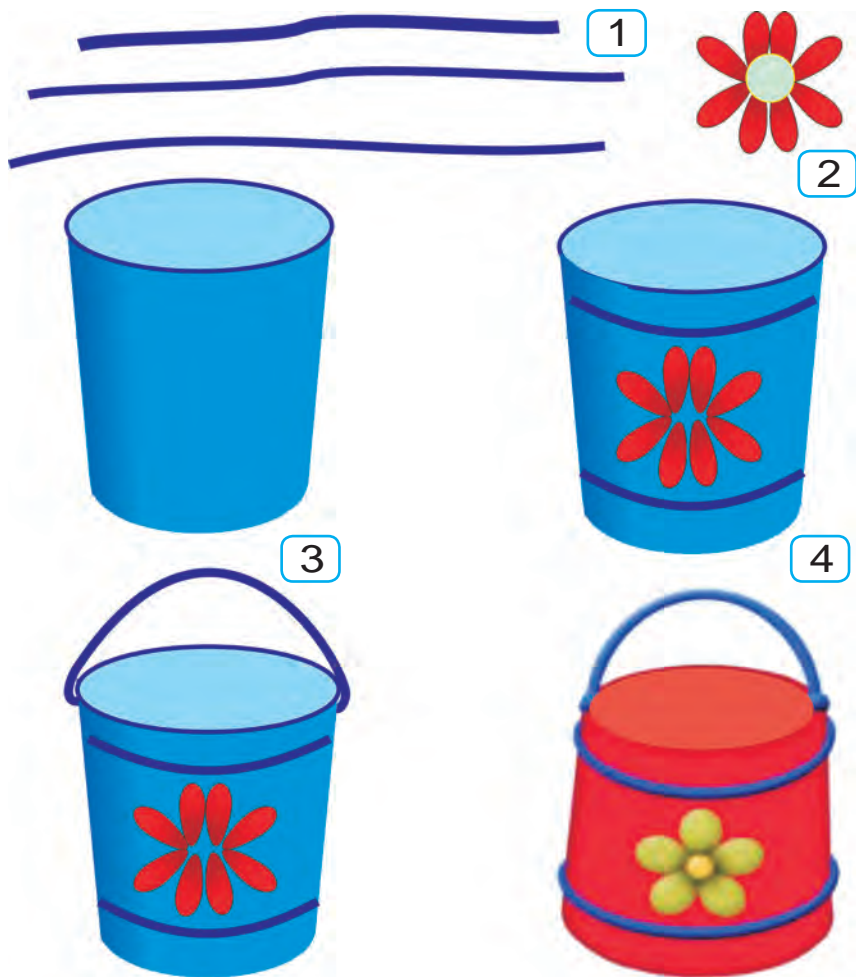

LAGAN YASASH



1



2

?

Oshxona idishlariga nimalar kiradi?



3



4



5



Oshpaz – iste'mol mahsulotlaridan turli xil vitamingga boy va mazali ovqatlarni tayyorlash bilan shug'ullanuvchi kasb egasi.



KARTONDAN HARAKATLANUVCHI O'YINCHOQLAR YASASH



Karton qog'ozga ayiqcha qismlarini chizing va qirqib oling.

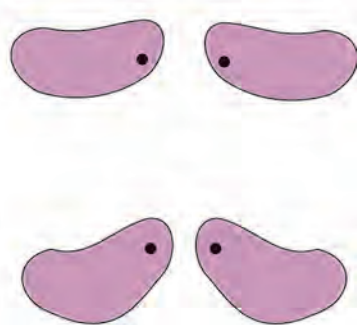
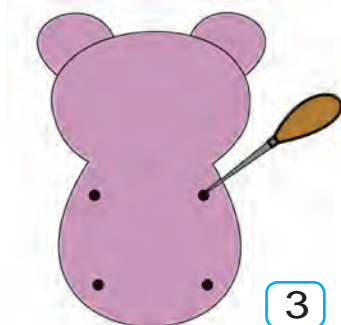
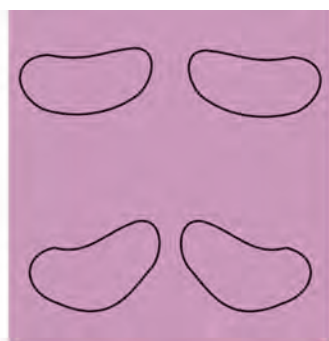
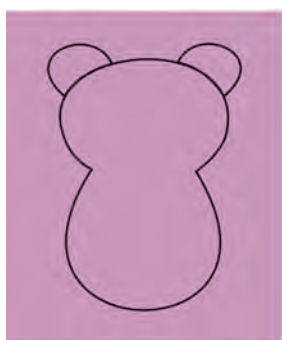

Ayiqcha qismlarini biriktirish o'rnini o'qituvchi nazoratida, bigizda teshib oling.



Ayiqcha qismlarini temir moslamalarda birlashtirish tavsiya etiladi.

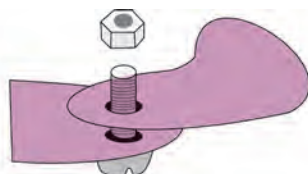

5

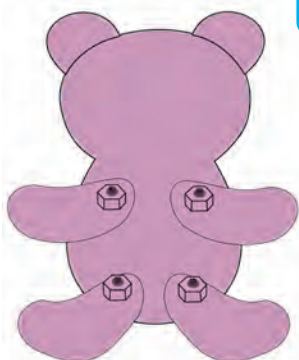

6

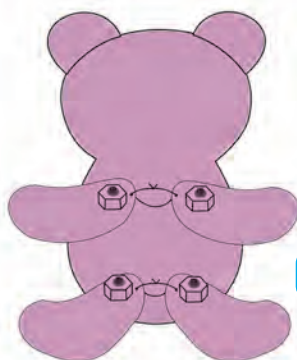

7

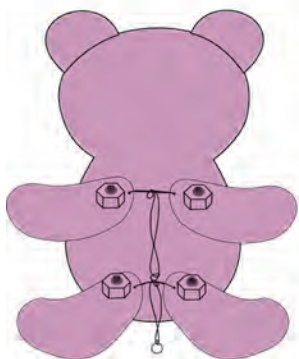

8



Mustaqil boshqa o'yinchoqlar yasab ko'ring.



URUG'LARDAN MOZAIKA USULIDA XO'ROZ YASASH

!

Urug'larni ishga tayyorlab oling.



Olma urug'i



Qovoq urug'i



Tarvuz
urug'i

Poliz ekinlari urug'laridan xo'rozni
birgalikda yasaymiz!

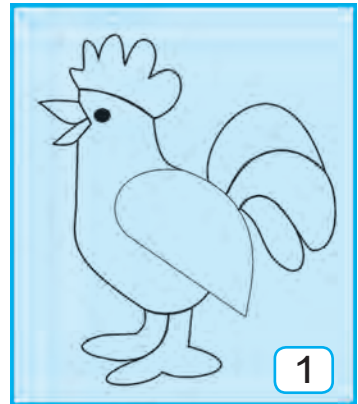

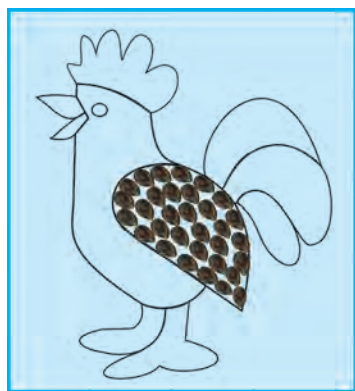

2



3



Urug'larni tartib bilan joylashtiring.

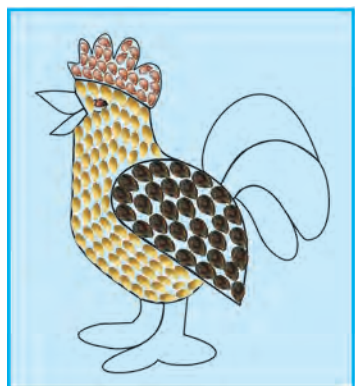

4



5

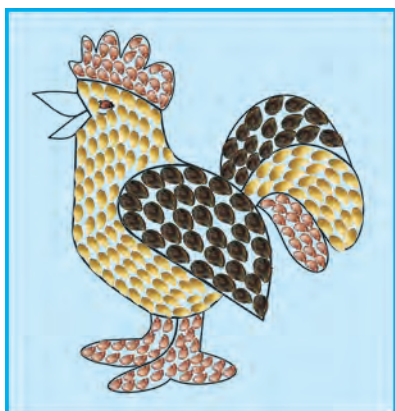

6



Bu ishlarni o'zingiz mustaqil bajar-
ring.



Qovoq va tarvuz urug'idan foydala-
ning.



TABIY MATERIALLAR BILAN ISHLASH

BARGLARDAN ATIRGUL YASASH



1



2



Barglarni ishga tayyorlab oling.



3



4



5



6

?

Atirgul haqida qanday she'r bilasiz?



7



8



9



10



11



Ota-onangiz yordamida gullarning boshqa turlarini ham yasab ko'ring.



TURLI GEOMETRIK SHAKLLARDAN HARAKATLANUVCHI MODELLAR YASASH



Harakatlanuvchi model qismlarini qo'g'oz qutilardan yasash mumkin.

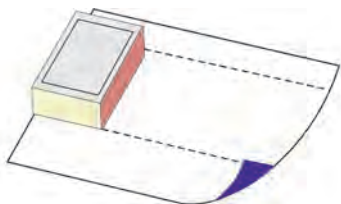

1

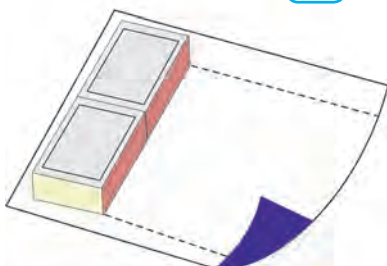

3

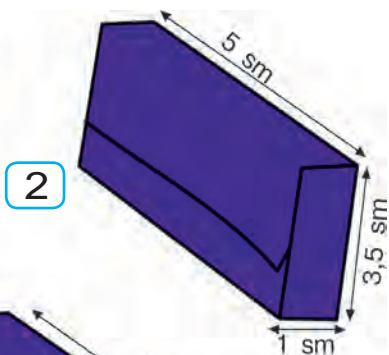

2

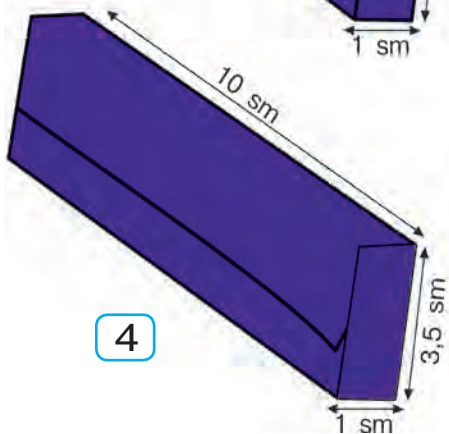

4



Harakatlanuvchi model qismlari o'l-chamlarini to'g'ri oling.



Mashina g'ildiraklarini yasashda plastmassa qopqoqlardan foydalaning.



5



6



Haydovchi erta tongdan kun botgunga qadar odamlarni o'z manzillariga bexatar yetib olishlari uchun xizmat qiladi. Haydovchi kasbi doim ziyraklik, hushyorlikni talab etadi. Haydovchi mashina, avtobus, tramvay, yuk mashinalarini boshqaradi.



QOG'OZDAN TIPRATIKAN APPLIKATSIYASINI YASASH

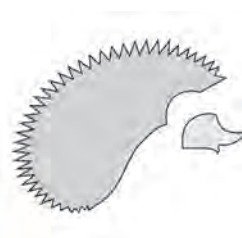

Rangli qog'ozdan applikasiya bo'laklarini qirqib oling.



3



4



5



6

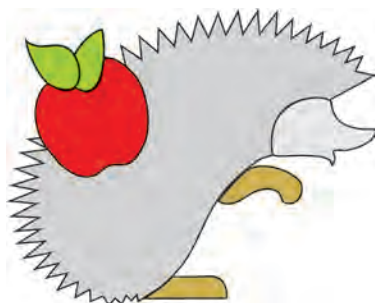

7

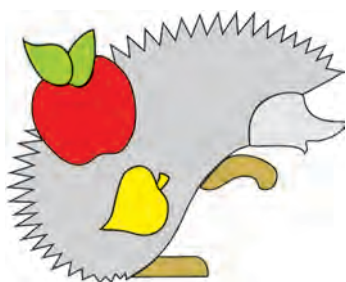

8

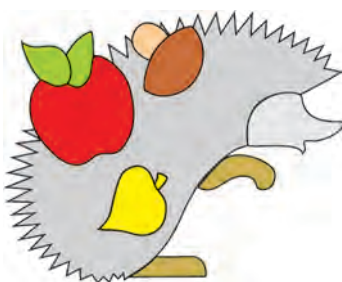

9

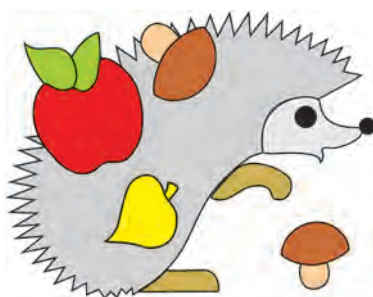

Mustaqil yasab ko'ring.





QOG'OZDAN MOZAIKA USULIDA ERTAK QAHRAMONINI YASASH



1

!

Ayiqchaga mos qog'oz bo'laklarini tayyorlab oling.

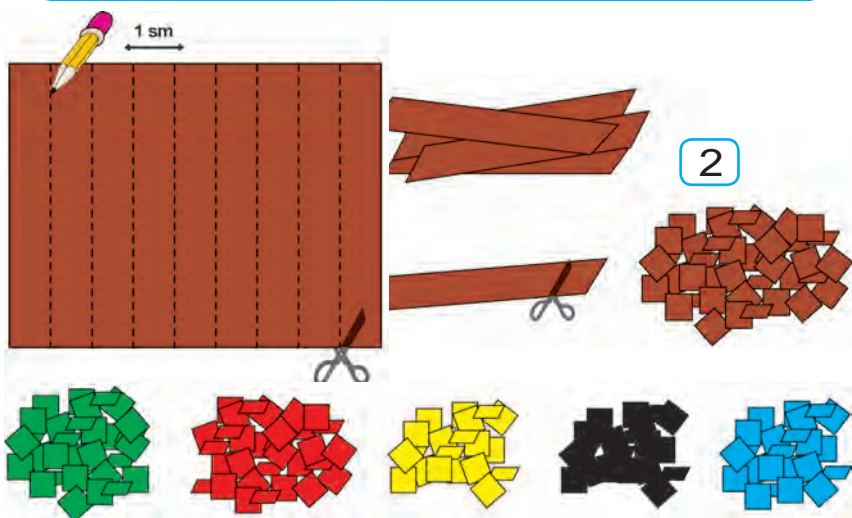

!

Mozaika ishini tartibli bajaring.



3



4

?

Ayiq qaysi taomni yaxshi ko'radi?



5



6

?

Ayiq qayerlarda yashaydi?



7



Qog'oz va urug'lardan foydalanib mustaqil bajarib ko'ring.





HAJMIDOR GUL SHAKLINI YASASH



Hajmdor gul shaklini yasashni bosqichma-bosqich bajaring.

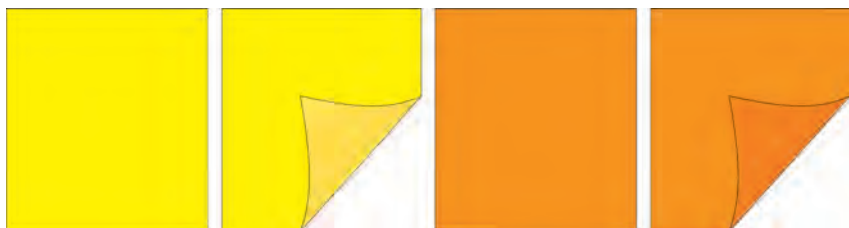

1

2



3

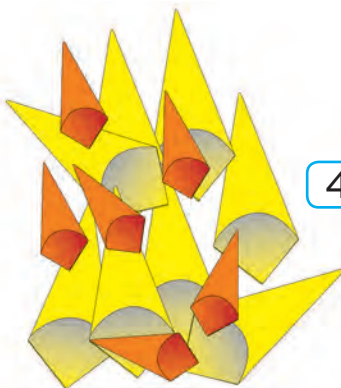

4



Qaychidan foydalanish qoidalariga rioya qiling.



Gulga mos ranglarni tanlang.

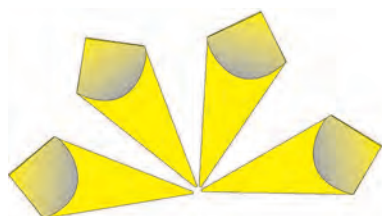

5

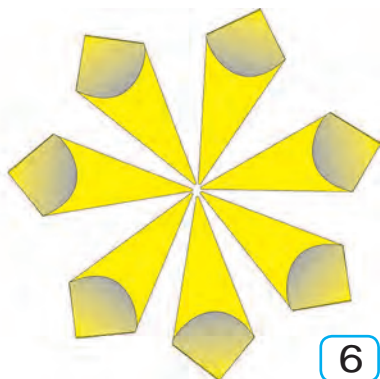

6

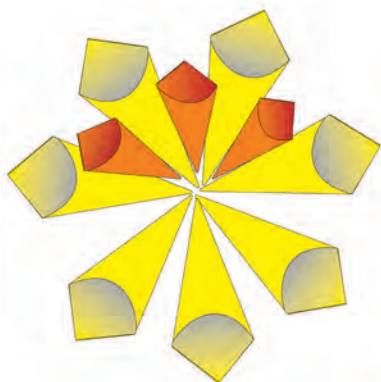

7

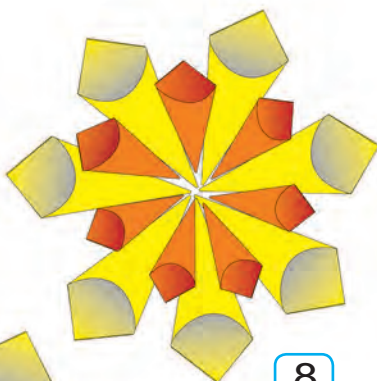

8

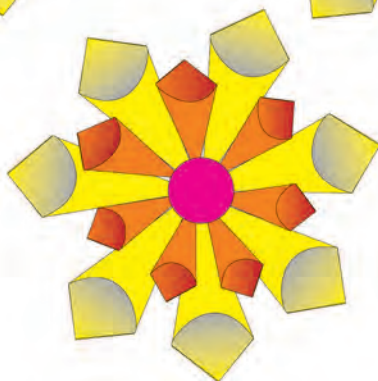

9



Hajmdor ko'inishdagi gullarni o'zingiz mustaqil yasang.

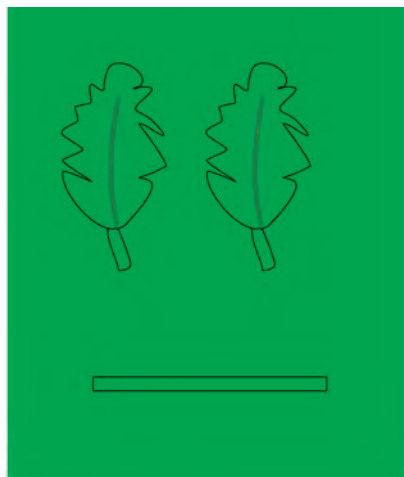

10

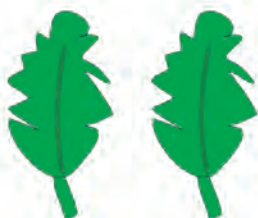

11

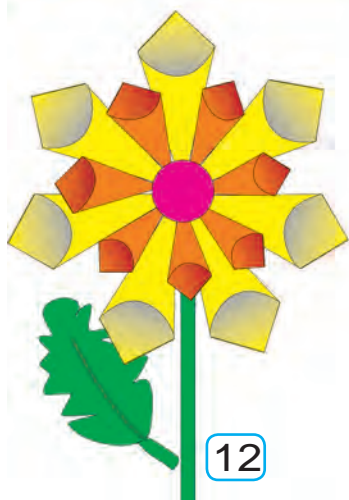

12

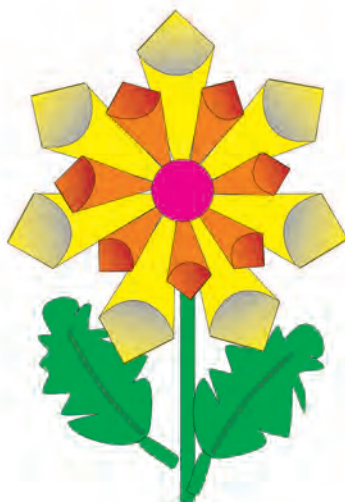

?

Gul yetishtiruvchi kasb egalari haqida nimalarni bilasiz?



RANGLI QOG‘OZDAN ARCHA BEZAKLARINI YASASH

!

Archa bezagini yasashni ketma-ketlikda, to‘g‘ri bajaring.



1



2



3



4

!

Qirqish chizig‘ini qalamda chizib oling.



5



6



7



8



9





Rangli qog'ozlardan archa o'yinchoqlarini mustaqil yasab ko'ring.

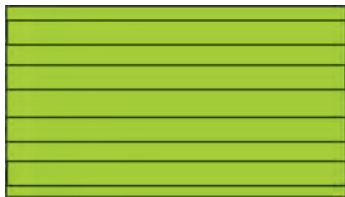

Qirqilgan qog'oz lentalarni yumaloq shaklda o'rab, bir-biriga yelimgang.

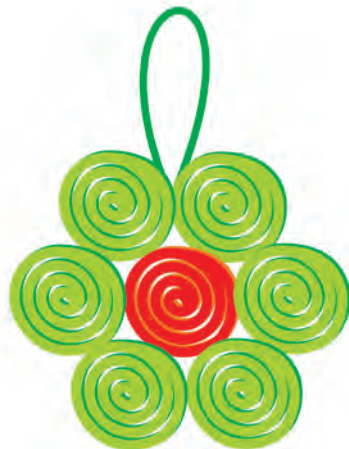



QOG'OZDAN O'YINCHOQLAR, GIRLYANGLAR YASASH



1



2



3



4



Xavfsizlik qoidalariga rioya qiling.

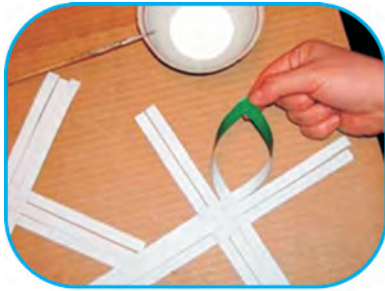

5



6



7



8



9



10



11



12



Archa o'yinchog'iga mos rang tanlang.



«QISH» APPLIKATSI- YASINI RANGLI QOG‘OZLARDAN YASASH



1

2

3

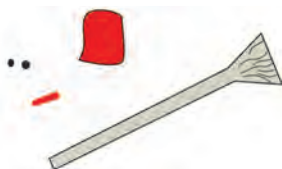
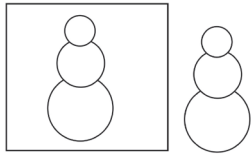

4

5

6





Mustaqil yasab ko'ring.



Igna va qaychidan foydalanishda xavfsizlik qoidalariga rioya qiling.





ZANJIR CHOKIDAN FOYDALANIB KASHTA TIKISH



1



2

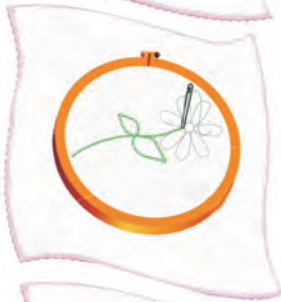

3



4



5



Ignadan foydalanishda xavfsizlik qoidalariga rioya qiling.



Siz ham shunday chok turlarini tikishga harakat qilib ko'ring.

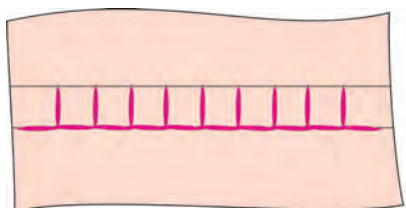

Petlya choki

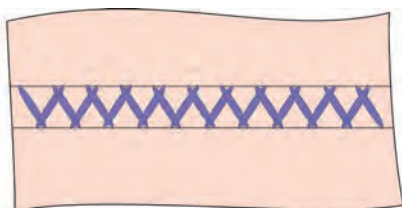

Archasimon chok

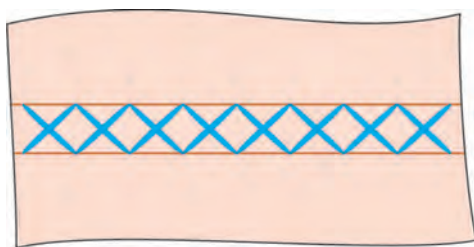

Ikssimon chok



Mustaqil tikib ko'ring.





KARTONDAN GULDON TIKISH



1

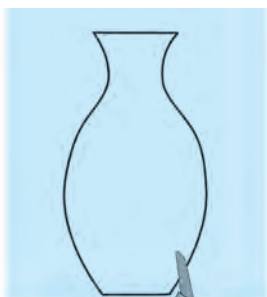

2



3



4



Guldon bo'laklarini andazaga moslab qirqib oling.



5



6



7



Guldon bo'laklarini biriktirib tikishda zanjir chokdan foydalanish tavsiya etiladi.



8



9



?

Guldonni yana nimalardan tikish yoki yasash mumkin?



CHOVGUN USHLAGICH TIKISH

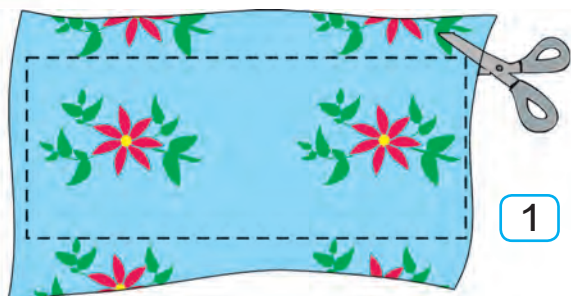

Chovgun ushlagichni tabiiy gazlama mato qoldiqlaridan tayyorlash mumkin.

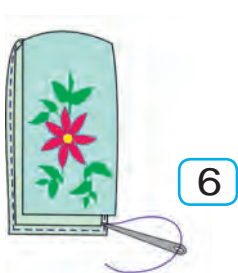

Chovgun ushlagichni paxtali matolar-
dan tayyorlash tavsiya etiladi.



YUMSHOQ O'YINCHOQ TIKISH

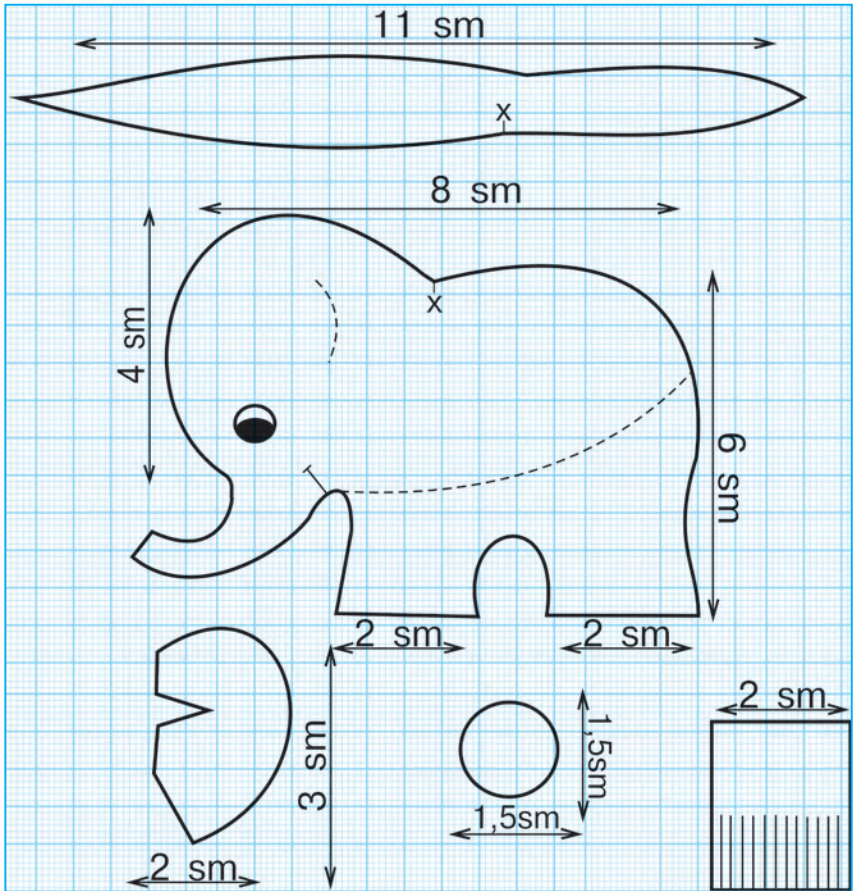

1

Filcha andazasini kartonga chizib, qir-qib oling.



Andazani gazlama ustiga qo'yib, o'qituvchi yoki ota-onangiz yordamida qirqib oling.

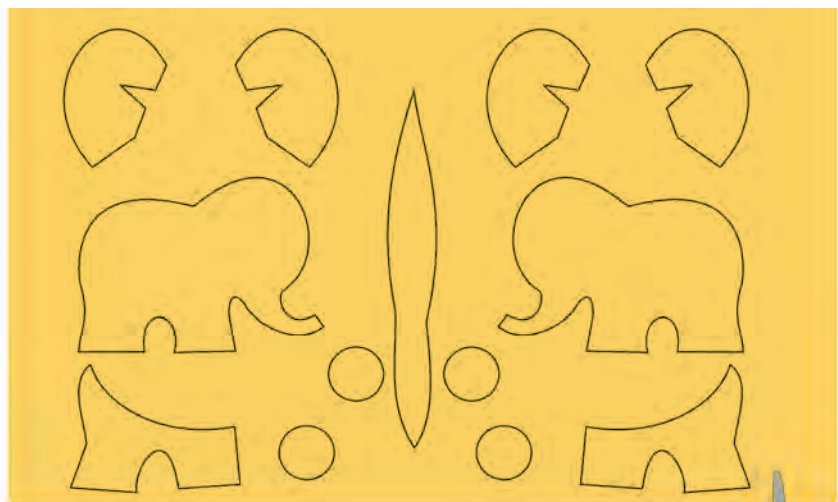

2

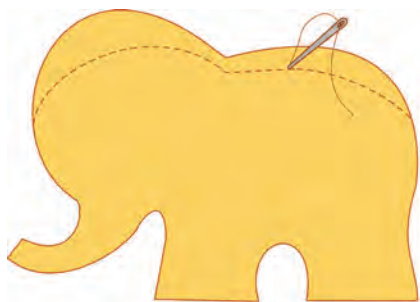

3

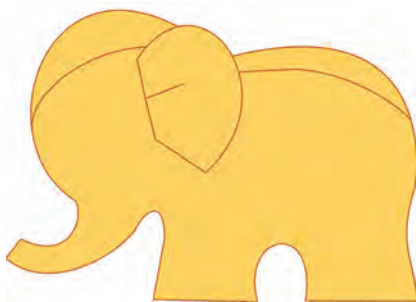

4

!

Har bir bo'lakni o'z o'rniga qo'yib tiking. Tayyor filcha ichini paxta yoki yumshoq buyum bilan to'ldiring.

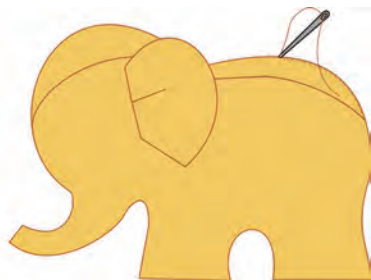
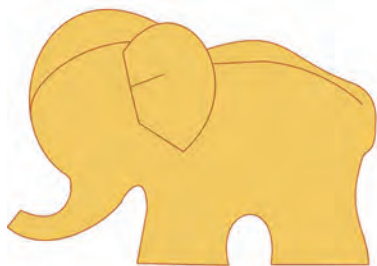

5

6

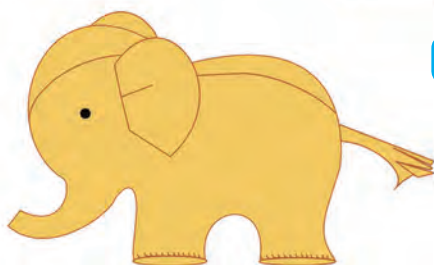

Mustaqil bajaring.





TO'QISH VA TO'QISH USULLARI



To'qish asboblaridan foydalanishda xavfsizlik qoidalariga rioya qiling.

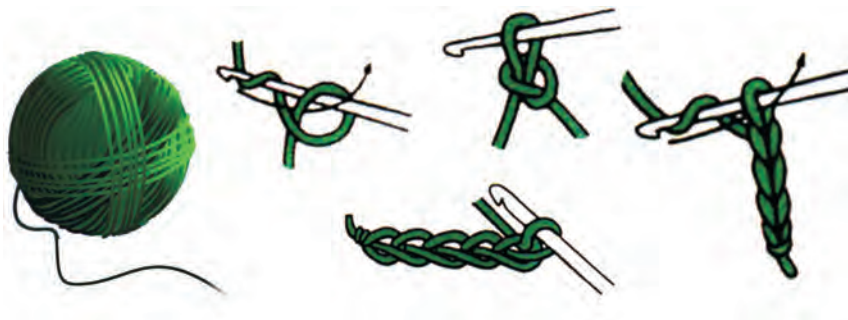

1



2



To'qish ketma-ketligida xato qilmang.



3



4



To'quvchi – turli xildagi iplardan uy buyumlari va kiyim-boshlarni tayyorlovchi kasb egasi.



5

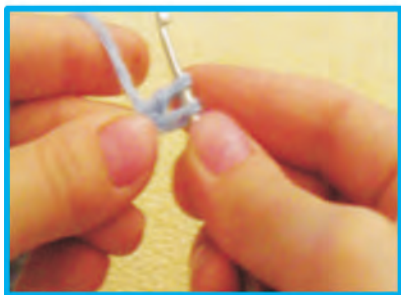

6



7



8

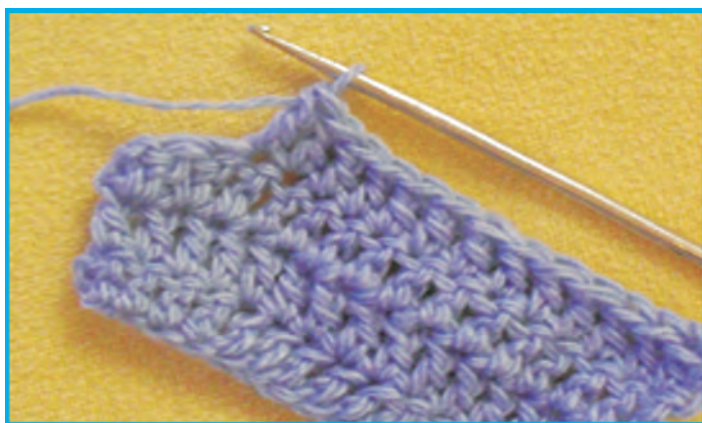

9



Mustaqil to'qib ko'ring.

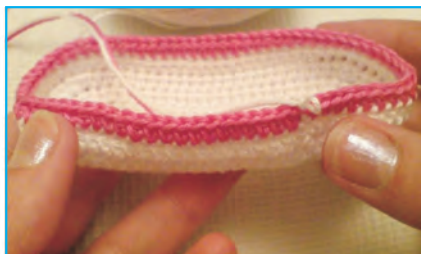



«SALFETKA» TO‘QISH USULI



Ishni to‘g‘ri va sifatli bajarishga harakat qiling.



1



2



3



4



Uy-ro‘zg‘or buyumlari uchun taglikni har xil ko‘rinishda ham to‘qish mumkin.



5



6



7



8

! O'qituvchingiz yoki ota-onangiz yordamida bajarib ko'ring.





RANGLI QOG'UZ VA KARTONDAN FOYDALANIB SURATLAR UCHUN RAMKA TAYYORLASH



Kartonni ishga tayyorlab oling va rangli kartondan ramkaning ustki qismini yasang.



1



2

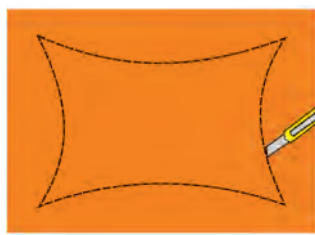

3

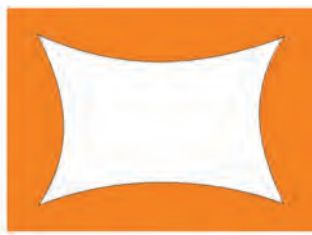

4

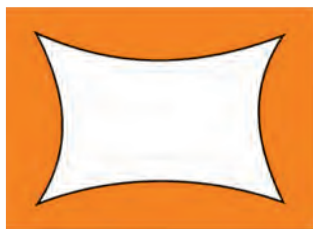

5



6

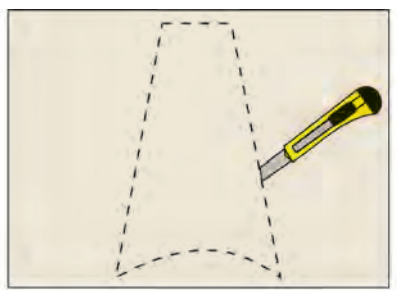

7

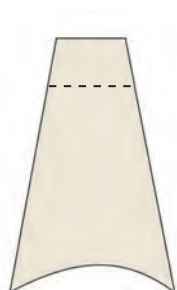

8

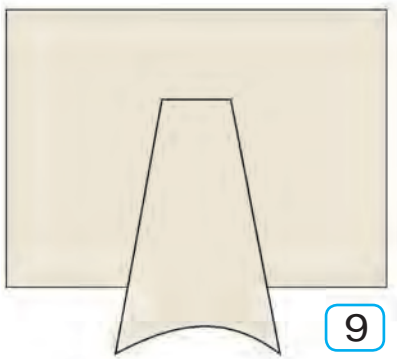

9



Suratlar eng go'zal damlarimizdan esdalik. Ularni mohir suratkashlar yaratadi.





8-MARTGA BAYRAM TABRIKNOMASINI YASASH

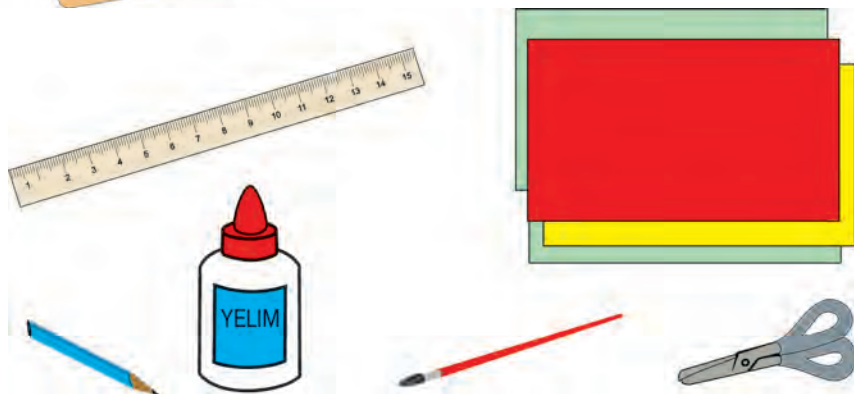

!

Kerakli ish quollarini tayyorlab oling.

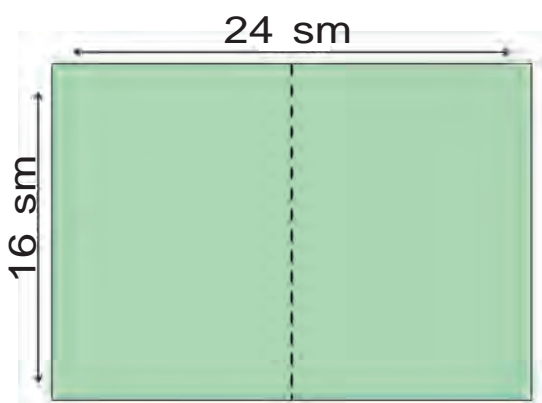

1

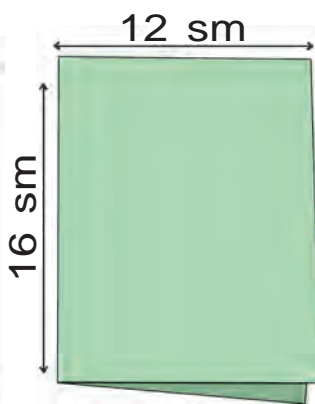

2



O'lchami va rangini to'g'ri tanlang.

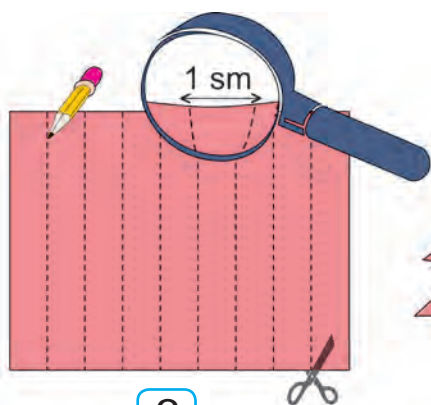

3



4



5



6

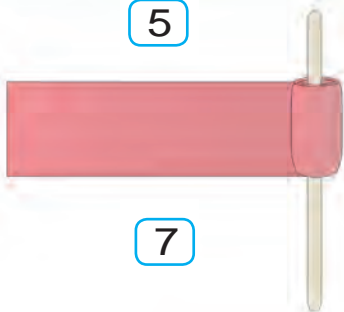

7

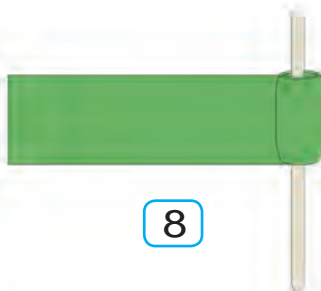

8

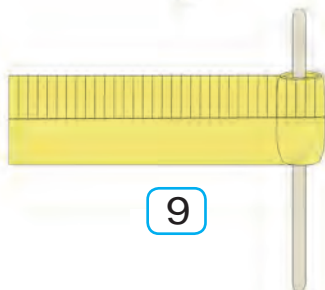

9



10



11



12



13



14



15



16



17



18



19



20



Oyijonim, qutlug' bo'lsin,
Go'zal bahor bayramingiz.
Quchog'ingiz gulga to'lsin,
Shodliklarga har damingiz.

Ollobergan Po'lat





QOG'OZNI BUKLASH USULIDA GULLAR YASASH

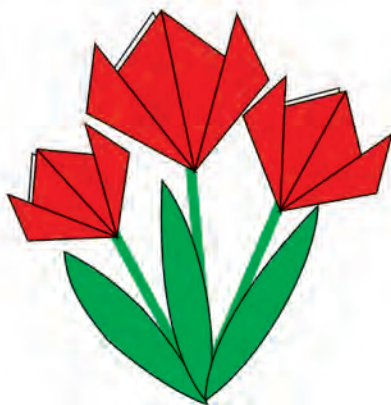
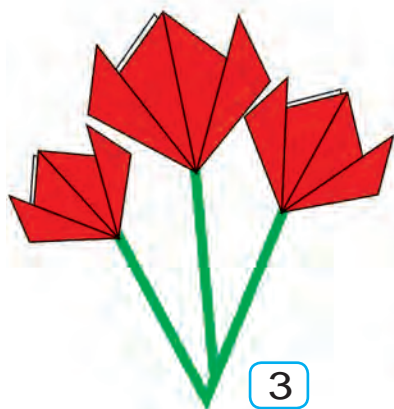
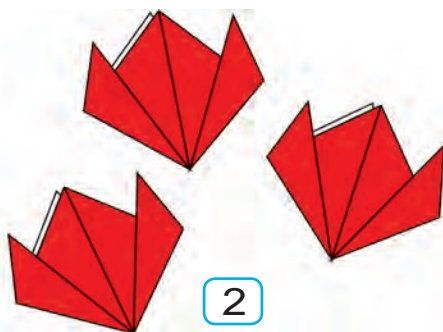
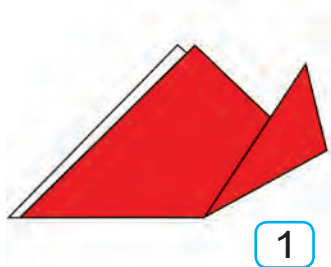

?

Lola guli qanday ranglarda bo'ladi?



Mustaqil bajaring.

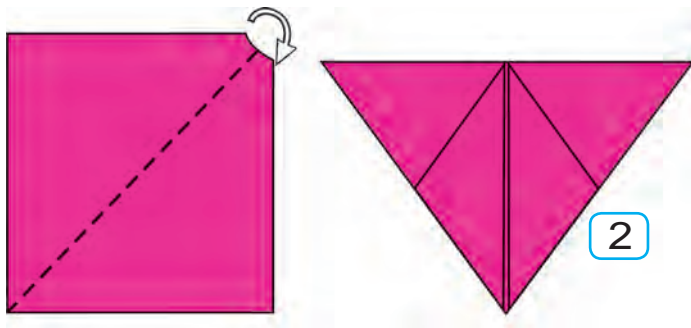

1

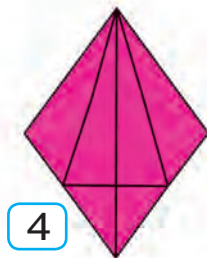
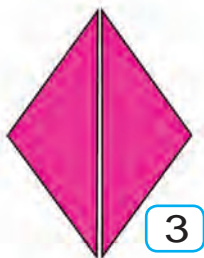

?

Lola qaysi faslda va qayerlarda o'sadi?



Mustaqil yasang.



Applikatsiya usulida gullarni yasang.





APPLIKATSIYA

«BAHOR»



1



2



3



4



5



Yumshoq salfetka qog'ozidan foydalaning.



Detallarni chizing va qirqib oling.

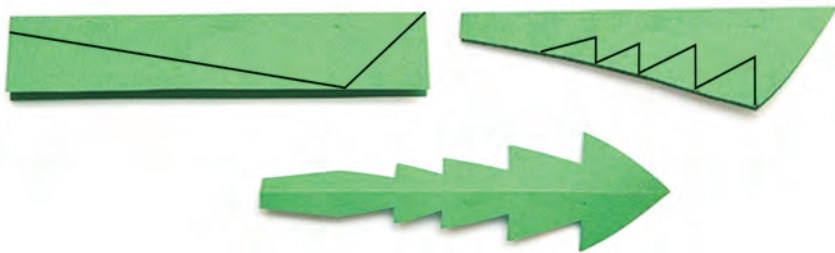

6





NAVRO'Z BAYRAMIGA TABRIKNOMA YASASH

Qozonlarda sumalak,
Yoziq dasturxon.
Navro'z bayram muborak,
Ey, O'zbekiston!

Rauf Tolib

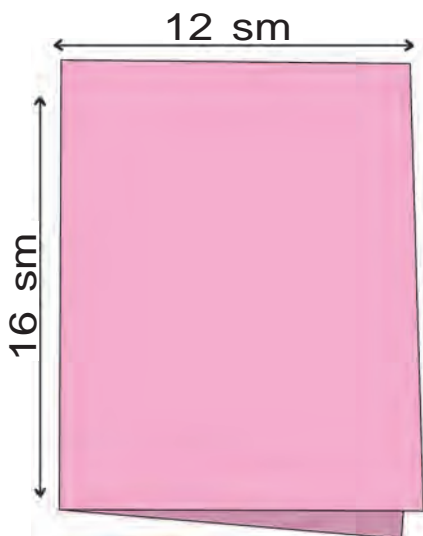

1

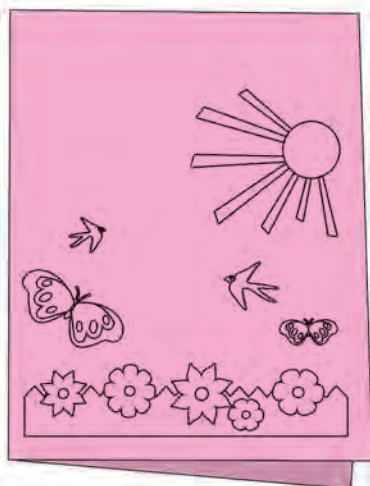

2



Qushlarga g'amxo'rlik qiling!



3



Tabriknoma bezaklarini tayyorlab oling.

?

Navro'z bayramida tayyorlanadigan taomlarning nomlarini bilasizmi?



4



5



?

Navro'z haqida qanday she'rlar bilasiz?



PAPE-MASHE USULIDAN FOYDALANIB IDISHLAR YASASH



!

Piyola sirtiga vazelin yoki moy surtiladi. Qog'oz olib, uni mayda bo'laklarga bo'lamiz. Qog'oz bo'laklarini suvga botirib, piyola yuzasiga tekis qilib yopishtiriladi. Ikkinchi qavatiga un va suvdan tayyorlangan suyuq yelim yordamida qog'oz bo'laklari yopishtirib chiqiladi.



4



5

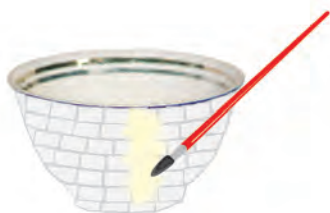

6



7

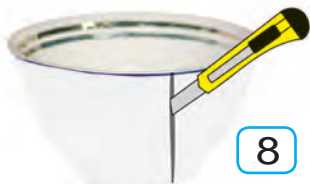

8

!

Qog'oz bo'laklari ikkinchi qavatga uzunasiga yelimlanadi. Bu esa qog'oz qavatlarini yanglishib ketishdan saqlaydi. Bu holat 6–7 marotaba takrorlanadi.



9



10

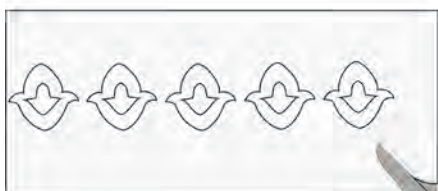

11

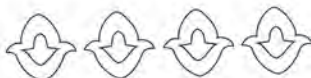

12

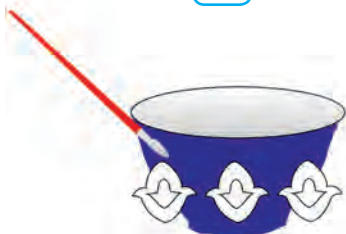

13



Piyola 3 kun mobaynida quritishga qo'yiladi. So'ng piyola sirtiga rangli qog'ozdan bezak beriladi.



XOTIRA VA QADRLASH KUNIGA TABRIKNOMA YASASH

!

Tabriknoma tayyorlashda ranglarni to'g'ri tanlang.

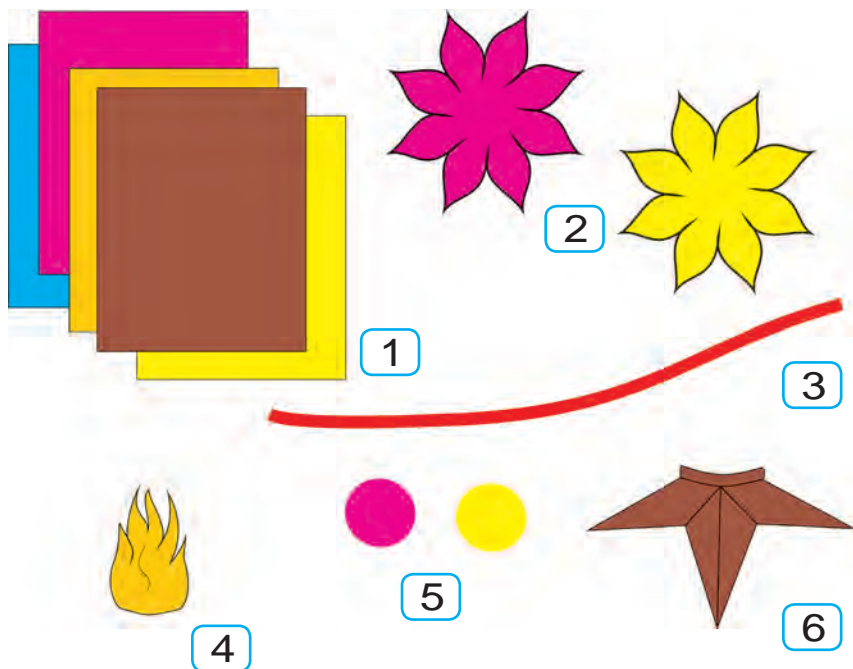

?

Xotira va qadrlash haqida nimalar bilasiz?



Tabriknoma uchun bezaklarni ketma-ketlikda birlashtiring.



7



8



Tabriknoma ichiga dil soʻzlaringizni yozishingiz mumkin.



«QUSH INIDA QUSH BOLASI» MAVZUSIDA KOMPOZITSIYA YASASH

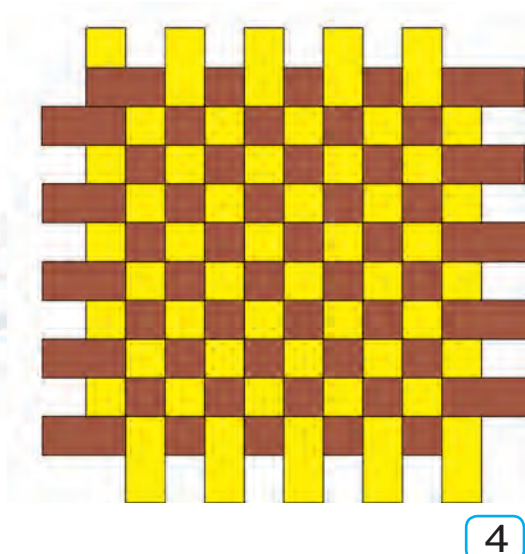
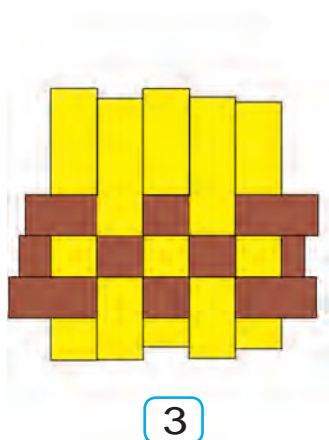
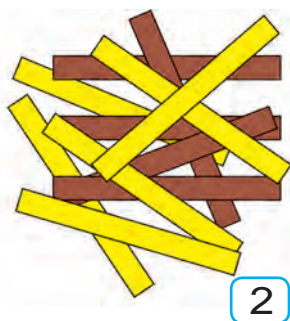

! Qirqilgan tasmalardan to'qish usulida gilamcha tayyorlang.

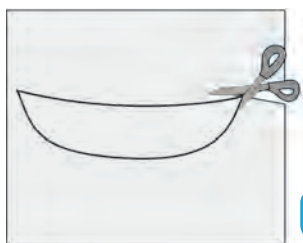

5

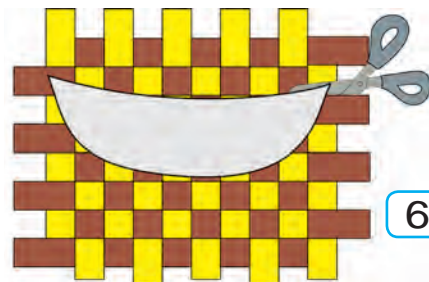

6



7



8



Qushlar bizning do'stimiz!



Tabiatni asrang!

Yana keldi qushchalar
Dengiz oshib, tog' oshib.
Uya qurdik nahordan,
Sayrashar «chug'-chug'»lashib.
Olobergan Po'lat



Mustaqil yasab ko'ring.

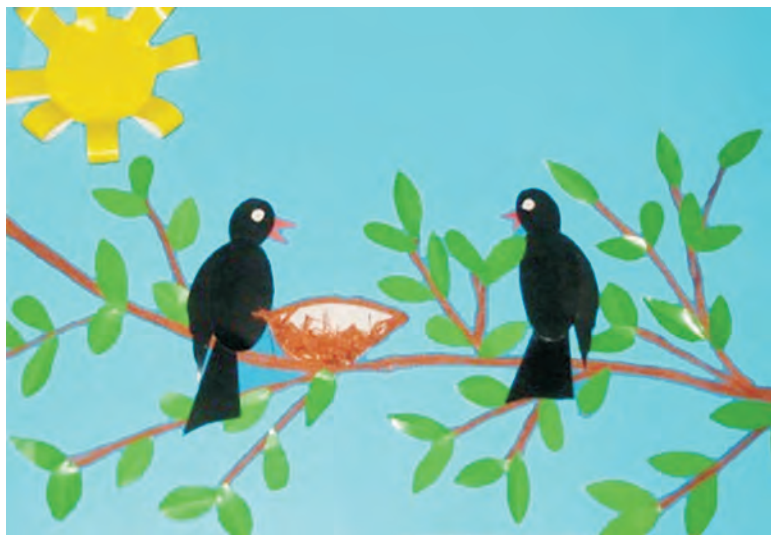



«YOZ» APPLIKATSIYASINI YASASH

!

Qog'ozdan qirqish usulida yoz fasli applikasiyasini yasang.

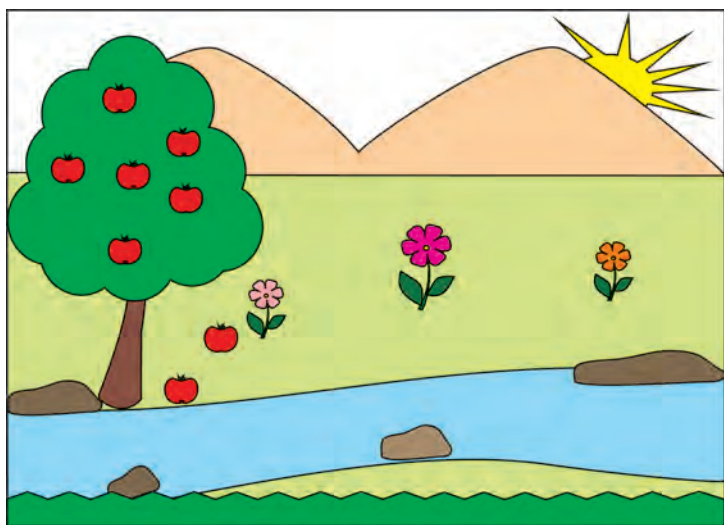
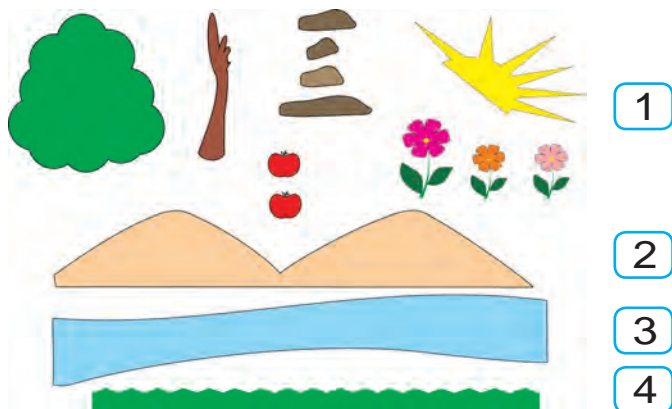

MUNDARIJA

Kirish.....	3
Mehnat ta'limi darsida bajariladigan ishlardan namunalar.....	4
1-dars. Mehnat ta'limi darsida foydalaniladigan ish qurollari	5
2–3-darslar. Tabiiy materiallardan applikatsiya yasash	7
4-dars. Qog'ozdan ayiqcha yasash.....	9
5-dars. Plastilindan idishlar yasash	12
6-dars. Kartondan harakatlanuvchi o'yinchoqlar yasash.....	14
7-dars. Urug'lardan mozaika usulida xo'roz yasash	16
8-dars. Tabiiy materiallar bilan ishlash	19
9-dars. Turli geometrik shakllardan harakatlanuvchi modellar yasash	22
10-dars. Qog'ozdan tipratikan applikatsiya- sini yasash	24
11-dars. Qog'ozdan mozaika usulida ertak qahramonini yasash	26
12–13-darslar. Hajmdor gul shaklini yasash	29
14-dars. Rangli qog'ozdan archa bezak- larini yasash	32
15-dars. Qog'ozdan o'yinchoqlar, girlyandlar yasash	35

16-dars. «Qish» applikatsiyasini rangli qog'ozlardan yasash	38
17-dars. Zanjir chokidan foydalanib kashta tikish	40
18-dars. Kartondan guldon tikish.....	42
19-dars. Chovgun ushlagich tikish	44
20–21-darslar. Yumshoq o'yinchoq tikish	46
22-dars. To'qish va to'qish usullari.....	49
23-dars. «Salfetka» to'qish usuli	52
24-dars. Rangli qog'oz va kartondan foydalanib suratlar uchun ramka tayyorlash	54
25-dars. 8-martga bayram tabriknomasini yasash	56
26-dars. Qog'ozni buklash usulida gullar yasash	60
27-dars. Applikatsiya. «Bahor»	63
28-dars. Navro'z bayramiga tabriknoma yasash	65
29–30-darslar. Pape-mashe usulidan foydalanib idishlar yasash.....	68
31-dars. Xotira va qadrlash kuniga tabriknoma yasash.....	71
32–33-darslar. «Qush inida qush bolasi» mavzusida kompozitsiya yasash	73
34-dars. «Yoz» applikatsiyasini yasash	76

O'quv nashri

Xamrakul SANAKULOV,
Dilrabo XODIYEVA, Aziza SANAKULOVA

MEHNAT TA'LIMI

**Umumiy o'rta ta'lim maktablarining
3-sinfi uchun darslik**

*O'zbekiston Respublikasi Xalq ta'limi
vazirligi tasdiqlagan*

«Sharq» nashriyot-matbaa
aksiyadorlik kompaniyasi
Bosh tahririyati
Toshkent – 2016

Muharrir *R. Nafasov*
Badiiy muharrir *K. Nurmanov*
Texnik muharrir *D. Gabdraxmanova*
Musahhah *M. Ziyamuhamedova*

Nashr litsenziyasi AI № 201, 28.08.2011-y.

Bosishga ruxsat etildi 22.06.2016. Bichimi 60x90 $\frac{1}{16}$.
«Arial» garniturası. Keglı 14 shponlı. Ofset bosma.
Shartlı bosma tabog'i 5,0. Nashriyot-hisob tabog'i 6,24.
Adadi 532628. nusxa. Buyurtma № 4330.

**«Sharq» nashriyot-matbaa aksiyadorlik kompaniyasi
bosmaxonasi, 100000, Toshkent shahri,
«Buyuk Turon» ko'chasi, 41.**

Ijaraga berilgan darslik holatini ko'rsatuvchi jadval

T/r	O'quvchining ismi, familiyasi	O'quv yili	Darslikning olingandagi holati	Sinf rahbarining imzosi	Darslikning topshirilgandagi holati	Sinf rahbarining imzosi
1						
2						
3						
4						
5						
6						

Darslik ijaraga berilganda va o'quv yili yakunida qaytarib olinganda yuqoridagi jadval sinf rahbari tomonidan quyidagi baholash mezonlariga asosan to'ldiriladi:

Yangi	Darslikning foydalanishga birinchi marotaba berilgandagi holati.
Yaxshi	Muqova butun, darslikning asosiy qismidan ajralmagan. Barcha varaqlari mavjud, yirtilmagan, ko'chmagan, betlarida yozuv va chiziqlar yo'q.
Qoniqarli	Muqova ezilgan, birmuncha chizilib, chetlari yedirilgan, darslikning asosiy qismidan ajralish holati bor, foydalanuvchi tomonidan qoniqarli ta'mirlangan. Ko'chgan varaqlari qayta ta'mirlangan, ayrim betlariga chizilgan.
Qoniqarsiz	Muqova chizilgan, u yirtilgan, asosiy qismidan ajralgan yoki butunlay yo'q, qoniqarsiz ta'mirlangan. Betlari yirtilgan, varaqlari yetishmaydi, chizib, bo'yab tashlangan, darslikni tiklab bo'lmaydi.