

**Elements of**  
**Applied Probability**  
————— for —————  
Engineering, Mathematics  
and Systems Science

This page intentionally left blank

# Elements of Applied Probability

————— for —————  
Engineering, Mathematics  
and Systems Science

David McDonald

*Department of Mathematics and Statistics  
University of Ottawa, Canada*

 **World Scientific**

NEW JERSEY • LONDON • SINGAPORE • SHANGHAI • HONG KONG • TAIPEI • BANGALORE

*Published by*

World Scientific Publishing Co. Pte. Ltd.

5 Toh Tuck Link, Singapore 596224

*USA office:* Suite 202, 1060 Main Street, River Edge, NJ 07661

*UK office:* 57 Shelton Street, Covent Garden, London WC2H 9HE

**Library of Congress Cataloging-in-Publication Data**

McDonald, David, 1947–

Elements of applied probability for engineering, mathematics and systems science / David McDonald.

p. cm.

Includes bibliographical references and index.

ISBN 981-238-739-0 (alk. paper) -- ISBN 981-238-740-4 (pbk : alk. paper)

1. Probabilities. I. Title

QA273 .M25 2004  
519'2--dc22

2003064852

**British Library Cataloguing-in-Publication Data**

A catalogue record for this book is available from the British Library.

Copyright © 2004 by World Scientific Publishing Co. Pte. Ltd.

*All rights reserved. This book, or parts thereof, may not be reproduced in any form or by any means, electronic or mechanical, including photocopying, recording or any information storage and retrieval system now known or to be invented, without written permission from the Publisher.*

For photocopying of material in this volume, please pay a copying fee through the Copyright Clearance Center, Inc., 222 Rosewood Drive, Danvers, MA 01923, USA. In this case permission to photocopy is not required from the publisher.

This book is dedicated to Nasrin, Omid and Sara.

I wish to thank my colleague, Professor Gail Ivanoff, for her support in adopting the preliminary version of this book for her course and for her many comments and corrections.

Successive generations of students taking SYS5120/Mat4371 at the University of Ottawa have field tested various versions of this book. Among those students, I particularly wish to thank Nadine Labrèche for tenaciously plowing through preliminary versions.

Finally, I acknowledge the support of the Ecole Normale Supérieure in Paris where I finished the book in the heat of the summer of 2003.

This page intentionally left blank

# Preface

*This text in applied probability is designed for senior engineering, mathematics and systems science students. In addition I have used the optional, advanced sections as the basis of graduate courses in quality control and queueing. It is assumed the students have had a first course in probability but that some need a review. Discrete models are emphasized and examples have been chosen from the areas of quality control and telecommunications. The text provides correct, modern mathematical methods and at the same time conveys the excitement of real applications.*

No physical measurement is infinitely precise and so, at some scale, is a discrete measurement. Here we take the point of view that the most interesting concepts in applied probability are discrete in nature and hence the description should not be complicated by measurability conditions implicit in a continuous model. The discrete model also has tremendous advantages. The complexity of conditioning continuous random variables disappears. Conditioning on the past of a random sequence becomes a simple application of Bayes' formula rather than a projection onto an  $L^2$  space! Moreover, the discrete model allows one to do coupling in a transparent way and coupling methods are used throughout the book. Of course, continuous approximations may offer simplified descriptions and easier computations so naturally we will use this tool. We do not, however, pursue the theory to cover the continuous case. On the other hand, within the constraints of the discrete model, the most modern methods are presented.

Painful experience over the years has shown that the abstract model and especially the definition of  $\sigma$ -fields on probability spaces given in Chapter 2 is not everyone's cup of tea. The probability primer in Chapter 1 provides an overview of Chapter 2 by giving an equiprobability model describing a random experiment associated with a no-frills example. In some cases it may therefore be advisable to assign the primer as background reading and then skip directly to Chapter 3. The results in Chapter 2 are then referenced as needed. A first course might then be completed by covering Chapter 3 and the first few sections of Chapters 4, 5 and 7 or Chapter 4, 5 and 8. Proofs are kept to a minimum in these sections but the main computational tools are given. This results in the condensed version of the course

described as the Systems Science course in the following diagram. The sections which are marked with a star give the proofs and more advanced material.

An advanced class would read Chapter 1 for the background on the “information highway” but the instructor would start in Chapter 2. Following the Flow Chart for the Mathematics Course below the instructor might complete most of the book in two quarters or perhaps one semester. The sections marked with a star give the proofs and advanced material while those marked with two stars are more advanced or on special topics.

On-line quality control procedures are emphasized and the Cusum is treated including a proof of optimality to cap off the last chapter. The “information highway” is described in the introductory Chapter 1 and used as an example throughout the book. Some examples are worked out using *Mathematica* and the commands are given in the text. These topics are received enthusiastically by the students and while some students don’t have access to *Mathematica*, I think it essential to illustrate the interplay between the theory and the enormous computational power available today.

This book is my best effort at trying to sell the subject of applied probability to a rather diverse audience. I believe the result is a course which is modern and mathematically sound but without too many prerequisites. It is my hope that this text will provide engineering, mathematics and systems science students with an accessible introduction to modern techniques in quality control and the performance analysis of computer and telecommunication systems.

David McDonald  
Ottawa, 2003



## A Systems Science Course

Ch. 1: Models  
background reading  
1.5, 1.6, 1.7



Ch. 3: Variables  
3.1 3.2  
3.3 3.4



Ch. 4: Poisson  
4.1 4.2 4.3  
4.4\* 4.5\*



Ch. 5: Chains  
5.1 5.2  
5.3 5.4

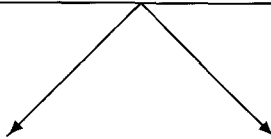

Ch. 7: Processes  
7.1 7.2 7.3  
7.4 7.5\*

Ch. 8: Decision  
8.1 8.2 8.3

**A Mathematics Course**

Ch. 2: Models  
2.1 2.2 2.3 2.4\*  
2.5 2.6\* 2.7\* 2.8\*\*



Ch. 3: Variables  
3.1 3.2 3.3 3.4\*  
3.5 3.6\* 3.7\* 3.8\*\*



Ch. 4: Poisson  
4.1 4.2 4.3  
4.4 4.5 4.6\* 4.7\*



Ch. 5: Chains  
5.1 5.2 5.3 5.4 5.5  
5.6\* 5.7\*

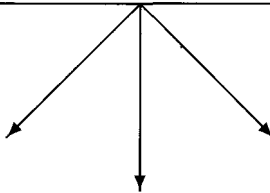

Ch. 7: Processes  
7.1 7.2 7.3  
7.4\* 7.5\* 7.6\*

Ch. 6: Renewal  
6.1 6.2 6.3 6.4 6.6\*

Ch. 8: Decision  
8.1 8.2 8.3  
8.4 8.5\* 8.6\*\*

# Contents

1. Introduction	1
1.1 Telecommunications and Quality Control	1
1.2 The Digital Network	1
1.3 Quality Control	6
1.4 Exercises	14
1.5 A Probability Primer	17
1.6 A Random Sample	21
1.7 Joint Distributions	25
1.8 Exercises	28
2. Modelling a Stochastic Process	31
2.1 The Probability Space	31
2.2 Random Variables	38
2.3 Expectation	44
2.4 Conditional Probabilities	48
2.5 Independence	52
2.6 General Random Variables	55
2.7 Independence of General Random Variables	57
2.8 The Kolmogorov Extension Theorem	59
2.9 Exercises	64
3. Variables and Limit Theorems	71
3.1 Discrete Random Variables	71
3.2 Continuous Random Variables	76
3.3 Generating Functions	82

3.4	Law of Large Numbers . . . . .	85
3.5	Exercises . . . . .	92
4.	The Poisson Process . . . . .	99
4.1	Introduction . . . . .	99
4.2	Bernoulli Point Processes . . . . .	100
4.3	The Poisson Process . . . . .	104
4.4	Applications of the Poisson Process . . . . .	107
4.5	<i>A Further Characterization</i> . . . . .	110
4.6	The Poisson Approximation . . . . .	113
4.7	Nonhomogeneous Poisson Processes . . . . .	119
4.8	Exercises . . . . .	123
5.	Markov Chains . . . . .	127
5.1	Introduction . . . . .	127
5.2	Steady-State Markov Chains . . . . .	135
5.3	Convergence to Steady-State . . . . .	140
5.4	Reversible Markov Chains . . . . .	147
5.5	Hitting Probabilities . . . . .	150
5.6	Proofs of Convergence to Steady State . . . . .	161
5.7	Transience and Recurrence . . . . .	165
5.8	Existence and the Strong Markov Property . . . . .	169
5.9	The Watched Process . . . . .	171
5.10	Foster's Criterion for Stability . . . . .	175
5.11	Exercises . . . . .	177
6.	Renewal Theory . . . . .	183
6.1	Introduction . . . . .	183
6.2	Renewal Reward Processes . . . . .	187
6.3	<i>Stationary Renewal Processes</i> . . . . .	192
6.4	Convergence to Stationarity . . . . .	203
6.5	Renewal with Nonlattice Variables . . . . .	209
6.6	Homogeneous Coupling . . . . .	210
6.7	The Bernoulli Part and Coupling . . . . .	214
6.8	Proof of the Coupling Theorem . . . . .	217
6.9	Regenerative Processes . . . . .	221
6.10	Exercises . . . . .	225
7.	Markov Processes . . . . .	229
7.1	Introduction . . . . .	229
7.2	The Generator of a Markov Process . . . . .	231
7.3	Queues and Time Reversal . . . . .	242

7.4	Jackson Networks . . . . .	250
7.5	Kelly or BCMP Networks . . . . .	254
7.6	Approximation by a Markov Process . . . . .	261
7.7	Exercises . . . . .	265
8.	Markov Decision Theory . . . . .	271
8.1	Introduction . . . . .	271
8.2	The Optimality Equation . . . . .	276
8.3	Infinite Horizon Decision Problems . . . . .	286
8.4	Continuous Time Decision Problems . . . . .	295
8.5	Optimal Stopping . . . . .	298
8.6	Quality Control - a Worst Case Analysis . . . . .	308
8.7	Exercises . . . . .	314
9.	Appendix . . . . .	319
9.1	Useful Results in Analysis . . . . .	319
9.2	Integration and Expectation . . . . .	319
9.3	Convexity . . . . .	322
9.4	Norms and Fixed Points . . . . .	324
9.5	Algebraic Results . . . . .	327
9.6	Further Reading . . . . .	328
9.7	Bibliography . . . . .	330
9.8	Solutions to Selected Problems . . . . .	334
9.8.1	Solutions to Selected Exercises in Chapter 1 . . . . .	334
9.8.2	Solutions to Selected Exercises in Chapter 2 . . . . .	336
9.8.3	Solutions to Selected Exercises in Chapter 3 . . . . .	338
9.8.4	Solutions to Selected Exercises in Chapter 4 . . . . .	342
9.8.5	Solutions to Selected Exercises in Chapter 5 . . . . .	346
9.8.6	Solutions to Selected Exercises in Chapter 6 . . . . .	349
9.8.7	Solutions to Selected Exercises in Chapter 7 . . . . .	352
9.8.8	Solutions to Selected Exercises in Chapter 8 . . . . .	354
	<i>Index</i> . . . . .	359

This page intentionally left blank

## Chapter 1

# Introduction

### 1.1 Telecommunications and Quality Control

A book on applied probability would be pointless without applications. There are a huge number of possibilities including applications to the biological sciences, to manufacturing or to the behavioural sciences but here we emphasize applications to telecommunications and to quality control.

### 1.2 The Digital Network

Real world applications of applied probability are as near at hand as your telephone. The information revolution is upon us. The integration of computing and telecommunications will change the way people live and work. Traditional services such as mail, bank transactions and newspaper subscriptions will be delivered electronically directly to the home along with telephone services. New services will emerge that we can't imagine. These services will be delivered on the information highway built on a network of fiber optical cables.

The traffic laws for this highway are hotly debated. Asynchronous transfer mode or ATM was conceived in the late nineteen eighties as international standard for the integrated services digital networks or ISDN networks capable of carrying the above mixture of services. This standard was designed to deliver the quality of service we expect from a telephone network. However, the advent of the world wide web changed everything! The light and easy internet protocol TCP/IP (Transfer Control Protocol over the Internet Protocol) was better adapted for delivering web pages. Today the TCP/IP protocol dominates but so far falls short in delivering the quality of service envisaged for ATM.

Both protocols are based on sending information in packets across the network. Under both ATM and TCP/IP, multimedia services such as digitized voice, text, image, video and computer communications are supported by dividing the data stream into ATM cells or TCP/IP packets. ATM cells are short, 53 byte packets while TCP/IP packets are of different sizes. These heterogeneous data streams can

be multiplexed together over a common transmission medium such as an optical cable. Consequently this high capacity medium must no longer be dedicated to a single data source.

In both protocols the routing information is in the header and the data follows. The format of an ATM cell is given in Figure 1.1 below:

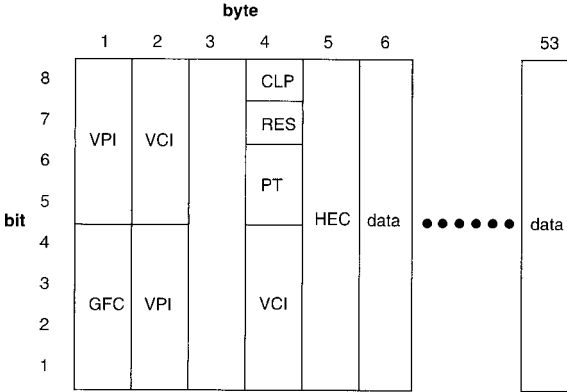

Fig. 1.1 The ATM cell

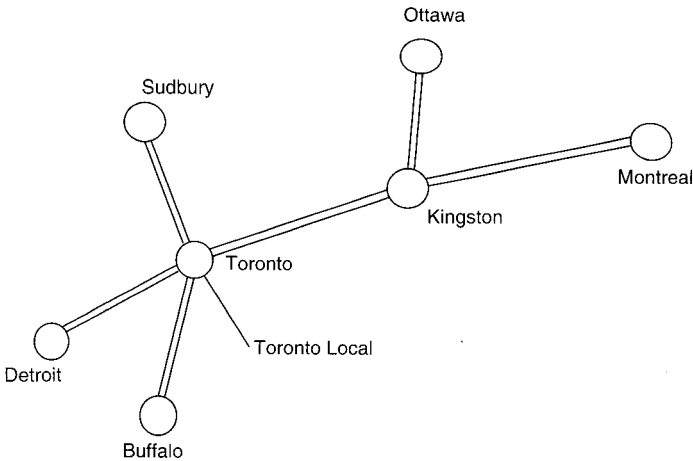

Fig. 1.2 An ATM network

On the information highway, asphalt and cement are replaced by fiber optical cables. Motor vehicles become cells or packets and the highway interchange is replaced by an electronic ATM switch or packet router. If vehicle traffic obeyed the laws of an ATM network then all vehicles would be of the same size and capacity



and they would carry passengers or cargo. A big delivery from Toronto to Ottawa could consist of a series or convoy of vehicles merged or multiplexed onto the high capacity 401 highway leading to Kingston along with all other vehicles headed that way. The drivers of the vehicles wouldn't know the destination but would carry an identifier which a dispatcher in Kingston would recognize. The dispatcher at the Kingston interchange would be looking for vehicles with this identifier and would know that these vehicles should be switched onto highway 15 toward Ottawa. There is in fact a virtual connection for all the vehicles involved in this delivery maintained by the dispatchers along the path. In an ATM cell in Figure 1.1 the passengers or cargo are the data in the 48 byte data field. The cell identifier is given in fields VPI (Virtual Path Indicator) and VCI (Virtual Channel Indicator).

If vehicle traffic obeyed the laws of a TCP/IP network then vehicles would come in variable sizes and capacities. A big delivery from Toronto to Ottawa would consist of a convoy of vehicles with drivers who know their final destination. When the vehicles arrive at the Kingston interchange the driver would tell the dispatcher his destination and the dispatcher would look up the best road in a routing table. The vehicle would then merge onto highway 15 if directed to do so. There is no virtual connection so in this sense an TCP/IP network is more like a real vehicle highway than an ATM network. TCP/IP is light and easy with no prearranged virtual path but as with the real traffic network there is no way to limit access to avoid traffic jams! This is the first major difference between ATM and TCP/IP. Finally, under TCP/IP, when each vehicle arrives Ottawa a small vehicle is dispatched back to Toronto acknowledging that this portion of the delivery was successfully made. This acknowledgement feedback in TCP/IP is another major difference between ATM and TCP/IP.

Let's consider what happens in an ATM network when a long distance telephone call is made from Toronto to Ottawa. When the number is dialed the signalling system called SS7 must set up the call. SS7 alerts the ATM switches in Toronto, Kingston and Ottawa that it has a call requiring a capacity of 64,000 bits a second plus the same amount to carry the other party's voice back to the caller. If that capacity is not available then the caller gets a busy signal. If the call is accepted SS7 ties up the resources and rings the other party. If the other party doesn't answer and the caller hangs up then SS7 will release the resources. If the other party answers, the ATM switches are notified to expect cells with given VCI-VPI identifiers. The Toronto switch knows it must send cells with this identifier to Kingston while the Kingston switch knows it must send such cells to Ottawa (not Montreal for instance). The Ottawa switch knows it sends cells with this identifier to a specific telephone number in Ottawa. This completes the ATM virtual circuit.

The mechanics of the same call on a TCP/IP network are still in flux. When conceived in 1983, TCP/IP was designed to deliver packets like registered letters sent through the postal service. Packets pass through a series of routers, are stored and then sorted and then sent on their way. When a letter is successfully delivered

an acknowledgement is returned to the source. This protocol was designed for reliable delivery over a failure prone network with military applications in mind. The concept of virtual circuits is foreign to TCP/IP and this prevents telephone operators from guaranteeing high quality calls. Nevertheless by tweaking TCP/IP, voice over TCP/IP is becoming common and this is pushing down the cost of personal communication.

For simplicity we will mostly consider ATM here since switching fixed length cells is easier to analyze than routing variable length packets (in fact some TCP/IP routers break packets in fixed length cells for switching purposes and then reassemble the packet at the output port). One should bear in mind that technological changes like optical switching will eventually make both these protocols obsolete. Nevertheless, if past history is any guide, the mathematical concepts studied here will remain relevant for evaluating the performance of newer technologies.

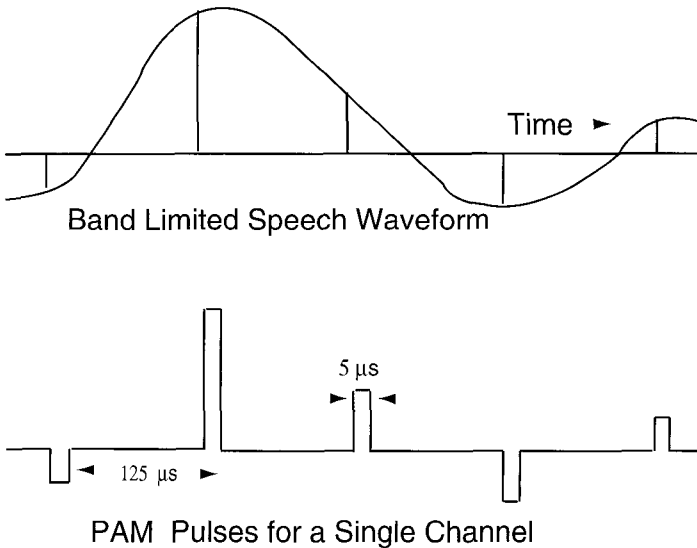

Fig. 1.3 Speech sampling

The mechanics of converting voice to information hasn't changed in 40 years. The caller's voice compresses a diaphragm in the mouth piece of the telephone which generates an electric current which is detected at the local telephone wire center. This signal voltage is measured or sampled at the wire center every 125 microseconds or 8,000 times a second. The voltage is quantized and encoded into 8 bits or 1 byte; that is 64,000 bits or 8000 bytes are produced every second. Six milliseconds worth of speech makes 48 bytes which is exactly the data content of an ATM cell. This is about right because the human ear can't distinguish delays shorter than 6

milliseconds. Similarly TCP/IP packets may carry about 6 milliseconds worth of voice data from a single source. Hence each speaker would produce a stream of cells or packets at a rate of about 6 per millisecond.

Alternatively the cell may serve as a frame to carry one byte from 48 different speakers between the same two points on the network. If 48 customers were simultaneously calling Ottawa from Toronto they each would produce a byte every  $1/8000$  of a second and these bytes would be assembled into one cell and sent. At the receiving end these bytes would be disassembled and sent to the separate receivers. This would produce a stream of cells at a rate of 8000 per second. In this way ATM can emulate the TDM (Time Division Multiplexing) system currently in use around the world. Naturally more customers can be accommodated by managing separate streams of frames. The same techniques can be used to carry voice over IP (VoIP).

The cells associated with our speaker arrive in Kingston, the header is identified and the ATM switch in Kingston switches these cells onto the Ottawa trunk. On arrival in Ottawa the header is again identified and the switch routes these cells to the local wire center in Ottawa. At the local wire center the digitization procedure is reversed and a voltage is sent down the line to the other party. This voltage drives the speaker in the other party's telephone and the speaker's words are received.

The projected rate of the trunk lines is 10 gigabytes per second; that is around 10,000,000,000 bytes per second or around 200,000,000 cells per second. On an ATM network this means that between consecutive cells from our speaker the switch sends out roughly 1,000,000 cells. These cells could be used for other speakers so in principal a million other callers could be using this trunk simultaneously! The enormous trunk capacity will of course be used for other kinds of traffic. Combining the cells or packets of various sources onto a single trunk is called multiplexing and this multiplexing of traffic results in a substantial increase in the carrying capacity of a single trunk. In fact since no source books a particular time slot, if a source has no cell or packet to send in a given time slot then this spare capacity can be used by somebody else. This is exactly what occurs in a telephone conversation. There are silence periods when the other party is talking. This means in fact that several million callers could use the same trunk line because most of any conversation is silence. Of course if everyone were speaking simultaneously and generating cells or packet at the peak rate then the trunk capacity will be inadequate. We hope this has small probability!

This is the basis of statistical multiplexing. More sources are accepted than could be handled if all sources transmit at peak rate and this increases the revenues of the telephone company. There is however an inevitable cost to pay. Conflicts or contention for resources will arise. A videoconference will generate about a million cells a second so a service of this kind will occupy a nonnegligible part of the trunk capacity. Hence the question of call admission becomes critical because too many videoconferences would disrupt telephone service to thousands of customers. A large computer file transfer might have the same effect but since a data transfer

is not usually time critical such a call might be accepted but delayed at a switch if that switch gets too busy. Telephone calls are very delay sensitive however so they must get high priority. On the other hand if the switch is really overloaded it might simply drop a few cells associated with a telephone call and nobody would ever notice. Dropping a few cells in a data transfer would be costly however, as the correct data might have to be retransmitted. Dropping the formatting cells in a video message might produce nonsense at the other end.

A simple large switch or router has no queuing at the input ports. Cells or packets are routed through the switch without queuing delay directly to buffers (or to a common buffer) at the appropriate output port. The cells or packets are then scheduled for transmission along the output link. In Exercise 1.1 we consider one output port comprising two buffers and a link in a  $2 \times 2$  ATM switch. The point of the exercise is to investigate the impact of different scheduling protocols for cells queued at the two competing output buffers. In fact modern switches now run more sophisticated protocols designed not only to reduce queue lengths and the associated delay but also to reduce the variability of the queuing delay so cells eventually arrive at the destination in a steady predictable stream.

The net effect of multiplexing many streams of data through a switch is clearly enormously complicated. It must be understood however because it is essential to decide ahead of time just how many traffic sources can be routed through this switch in order to avoid unacceptable delays and cell losses. This problem of admission control is still being hotly disputed. The problem is further complicated by the fact that a switch is receiving traffic directly from local sources or even local networks and also from other switches.

The performance of the ATM switch or the TCP/IP router will be judged not only on the average amount of traffic carried. It is also important to predict the proportion of cells or packets dropped as well as the average delay and the cell delay variation of cells or packets traversing the network. This results in complicated (but interesting) problems in *queuing theory*: the mathematical (and often probabilistic) theory of queues.

### 1.3 Quality Control

Many maintain the catastrophic decline of the North American automobile industry in the nineteen seventies and eighties resulted partly from the fact that foreign competitors adopted military quality control standards while the North American companies forgot all about quality. Quality control has many aspects. Acceptance sampling described below can be used by a buyer to force a supplier to deliver product of a specified quality. The supplier can avoid poor quality product by monitoring the production line using the on-line quality control schemes described in future chapters. The supplier can also design his product in such a way that minor imperfections in production do not result a poor quality product. The search for

these robust production regimes is called off-line quality control and is not treated in this book.

The most famous military acceptance standards are MIL-STD-414 for acceptance sampling by variables and MIL-STD-105D for acceptance sampling by attributes. The former is used when a quality measurement is available for elements of the sample. The later is used when one can only determine if the elements of the sample are defective or not. We consider MIL-STD-105D for historical reasons since MIL-STD-105D was replaced by MIL-STD-105E in 1989 and then by MIL-STD-1916 in 2001. MIL-STD-105D has also been incorporated into the International Standards Organization (ISO) standard called ISO 2859. Department of Defence (DOD) Specifications and Standards are available for public use through the DOD Scientific and Technical Information Network at the <http://stinet.dtic.mil> web site.

Essentially a standard is used like a contract between a supplier and a buyer. The two sides agree on a price and both sides agree the buyer will accept the product according to the procedures carefully set out in the standard. These procedures essentially punish the supplier if he produces an unreasonably high proportion of defective or nonconforming units. On the other hand he is rewarded if he produces a reasonably low proportion of nonconforming units. The key word is reasonable, and this is spelled out by the concept of acceptable quality level - AQL.

The AQL, agreed to contractually by the supplier and the buyer, is the percentage of nonconforming units in lots that will be accepted most of the time by the sampling scheme. In other words, if the lots submitted have a percentage of nonconforming units no greater than the AQL then the sampling scheme will accept the great majority of these lots. In practice the great majority means about 95%. The standard does caution however that this does not give the supplier the right to knowingly supply any nonconforming unit of product!

Imagine that a supplier produces resistors in large batches and a buyer wants to sign a long term contract for one lot of resistors every working day. The first step is to agree on an AQL. The buyer would like an AQL of 0 of course but the supplier knows he can't meet that standard at least not at a reasonable price. They settle on an AQL of 2.5% since the buyer knows he can easily detect the defective resistors in the process of building his product and therefore he is willing to do the necessary screening for a lower price.

They next agree that all lots will contain 1000 units. This determines the sample size code letter. Therefore the sample size code letter J is picked from the table below.

Lot size			General inspection level II
2	to	8	A
9	to	15	B
16	to	25	C
26	to	50	D
51	to	90	E
91	to	150	F
151	to	280	G
281	to	500	H
501	to	1,200	J
1,201	to	3,200	K
3,201	to	10,000	L
10,001	to	35,000	M
35,001	to	150,000	N
150,001	to	500,000	Q
500001	and	over	R

Next look at Figure 1.4. This outline describes four regimes for the scheme. The usual regime is normal inspection. If the supplier delivers very good quality a level of trust is established and the regime of reduced inspection is entered. This reduces the cost of sampling to the buyer. If the supplier delivers poor quality he is punished and the regime of tightened inspection is entered. If he doesn't pull up his socks while in tightened inspection, the inspection scheme is discontinued and its time to call in the lawyers to cancel the whole contract.

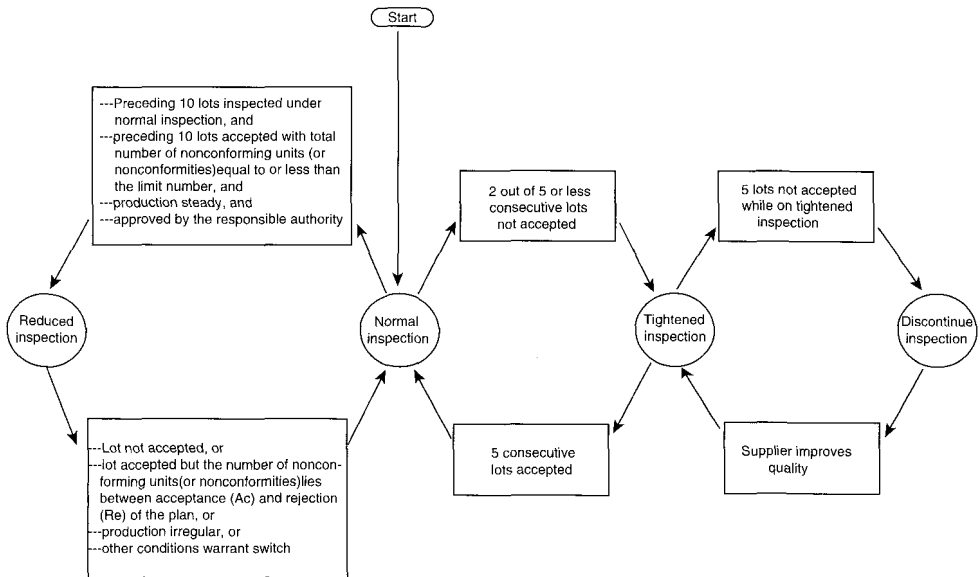

Fig. 1.4 The regimes of inspection under MIL-STD-105D.

Suppose we start with normal inspection. We read off the parameters from the Table II-A on page 10 across from code letter J. The sample size from each lot should be 80 and we accept the lot if no more than  $c=5$  nonconforming units are in the sample. If there are 6 or more we reject the lot and send it back to the supplier. We stay with normal inspection until one of the conditions is met in Figure 1.4. Suppose the conditions for tightened inspection are met; that is two out of five or worse consecutive lots have been non-acceptable. In this case the sampling scheme given in Table II-B on page 11 applies to subsequent lots. Reading off the parameters we see the sample size is still 80 but the buyer accepts the lot if no more than  $c=3$  nonconforming units are in the sample; otherwise the buyer rejects the lot. This puts the supplier in a tight spot. He knows that while in tight inspection he dare not have 5 more lots rejected or the sampling plan will be suspended and his contract is at risk. He will try very hard to supply good quality and return to normal inspection by having 5 lots in a row accepted.

The conditions for entering the reduced inspection regime are rather stringent. The preceding 10 lots inspected under normal inspection must be accepted. Next, the total number of nonconforming units in these 10 samples must be less than or equal the limit number in Table II-D on page 13. Hence the total number of nonconforming units in these 10 lots must be less than or equal to 14 since 10 samples of size 80 units or 800 in all were sampled. Moreover the production must be at a steady rate and finally some responsible authority must give an OK. Suppose the conditions for reduced inspection are met. In this case the sampling scheme given in Table II-C on page 12 applies to subsequent lots. Reading off the parameters we see the sample size is 32. This means less work for the buyer because he trusts the supplier. The buyer rejects the lot and returns to normal inspection if there are 5 or more nonconforming units. If no more than  $c=4$  nonconforming units are in the sample the buyer accepts the lot but only remains in the reduced inspection regime if the number of nonconforming units is no more than 2 and production is regular and no unwarranted conditions are observed.

The process average is the percentage of nonconforming units found in the samples submitted. If the proportion of nonconforming units in a lot is  $p\%$ , the  $OC$  curve at  $p\%$  gives the probability the lot will be accepted. Hence, if the process average is  $p\%$  then in the long run a proportion  $OC(p\%)$  of the lots will be accepted. The  $OC$  curves determined for the normal, tightened and reduced sampling plans are such that  $OC(2.5\%) \approx 95\%$ . The precise values can be calculated as we do for the scheme for testing shells in Example 3.4. This means that if the supplier maintains a process average of at most 2.5% nonconforming then 95% of his lots will be accepted.

Table II-A - Single sampling plans for normal inspection

## Acceptable quality levels (normal inspection)

sample size code letter	sample size	.010	.015	.025	.040	.065	.10	.15	.25	.40	.65	1.0	1.5	2.5	4.0	6.5	10	15	25	40	65	100	150	250	400	650	1000		
		Ac Re	Ac Re	Ac Re	Ac Re	Ac Re	Ac Re	Ac Re	Ac Re	Ac Re	Ac Re	Ac Re	Ac Re	Ac Re	Ac Re	Ac Re	Ac Re	Ac Re	Ac Re	Ac Re	Ac Re	Ac Re	Ac Re	Ac Re	Ac Re	Ac Re	Ac Re	Ac Re	Ac Re
A	2	↓	↓	↓	↓	↓	↓	↓	↓	↓	↓	↓	↓	↓	0 1	↓	↓	↓	1 2	2 3	3 4	5 6	7 8	10 11	14 15	21 22	31 32	41 42	51 52
B	3	↓	↓	↓	↓	↓	↓	↓	↓	↓	↓	↓	↓	↓	0 1	↑	↓	↓	1 2	2 3	3 4	4 5	5 6	7 8	10 11	14 15	21 22	31 32	41 42
C	5	↓	↓	↓	↓	↓	↓	↓	↓	↓	↓	↓	↓	0 1	↑	↓	1 2	2 3	3 4	4 5	5 6	6 7	7 8	10 11	14 15	21 22	31 32	41 42	51 52
D	8	↓	↓	↓	↓	↓	↓	↓	↓	↓	↓	↓	0 1	↑	↓	1 2	2 3	3 4	4 5	5 6	6 7	7 8	10 11	14 15	21 22	31 32	41 42	51 52	↑
E	13	↓	↓	↓	↓	↓	↓	↓	↓	↓	0 1	↑	↓	1 2	2 3	3 4	4 5	5 6	6 7	7 8	8 9	10 11	14 15	21 22	31 32	41 42	51 52	↑	↑
F	20	↓	↓	↓	↓	↓	↓	↓	↓	0 1	↑	↓	1 2	2 3	3 4	4 5	5 6	6 7	7 8	8 9	10 11	14 15	21 22	↑	↑	↑	↑	↑	↑
G	32	↓	↓	↓	↓	↓	↓	↓	↓	0 1	↑	↓	1 2	2 3	3 4	4 5	5 6	6 7	7 8	8 9	10 11	14 15	21 22	↑	↑	↑	↑	↑	↑
H	50	↓	↓	↓	↓	↓	↓	↓	0 1	↑	↓	1 2	2 3	3 4	4 5	5 6	6 7	7 8	8 9	10 11	14 15	21 22	↑	↑	↑	↑	↑	↑	↑
J	80	↓	↓	↓	↓	↓	↓	0 1	↑	↓	1 2	2 3	3 4	4 5	5 6	6 7	7 8	8 9	10 11	14 15	21 22	↑	↑	↑	↑	↑	↑	↑	↑
K	125	↓	↓	↓	↓	↓	0 1	↑	↓	1 2	2 3	3 4	4 5	5 6	6 7	7 8	8 9	10 11	14 15	21 22	↑	↑	↑	↑	↑	↑	↑	↑	↑
L	200	↓	↓	↓	0 1	↑	↓	1 2	2 3	3 4	4 5	5 6	6 7	7 8	8 9	10 11	14 15	21 22	↑	↑	↑	↑	↑	↑	↑	↑	↑	↑	↑
M	315	↓	↓	↓	0 1	↑	↓	1 2	2 3	3 4	4 5	5 6	6 7	7 8	8 9	10 11	14 15	21 22	↑	↑	↑	↑	↑	↑	↑	↑	↑	↑	↑
N	500	↓	↓	0 1	↑	↓	1 2	2 3	3 4	4 5	5 6	6 7	7 8	8 9	10 11	14 15	21 22	↑	↑	↑	↑	↑	↑	↑	↑	↑	↑	↑	↑
P	800	↓	0 1	↑	↓	1 2	2 3	3 4	4 5	5 6	6 7	7 8	8 9	10 11	14 15	21 22	↑	↑	↑	↑	↑	↑	↑	↑	↑	↑	↑	↑	↑
Q	1,250	0 1	↑	↓	1 2	2 3	3 4	4 5	5 6	6 7	7 8	8 9	10 11	14 15	21 22	↑	↑	↑	↑	↑	↑	↑	↑	↑	↑	↑	↑	↑	↑
R	2,000	↑	↑	1 2	2 3	3 4	4 5	5 6	6 7	7 8	8 9	10 11	14 15	21 22	↑	↑	↑	↑	↑	↑	↑	↑	↑	↑	↑	↑	↑	↑	↑

↓ = Use first sampling plan below arrow. If sample size equals or exceeds, lot or batch size, carry out 100 % inspection.

↑ = Use first sampling plan above arrow.

Ac = Acceptance number, Re = Rejection number



Table II-B - Single sampling plans for tightened inspection

Acceptable quality levels (tightened inspection)

sample size code letter	sample size	.010	.015	.025	.040	.065	.10	.15	.25	.40	.65	1.0	1.5	2.5	4.0	6.5	10	15	25	40	65	100	150	250	400	650	1000	
		Ac Re	Ac Re	Ac Re	Ac Re	Ac Re	Ac Re	Ac Re	Ac Re	Ac Re	Ac Re	Ac Re	Ac Re	Ac Re	Ac Re	Ac Re	Ac Re	Ac Re	Ac Re	Ac Re	Ac Re	Ac Re	Ac Re	Ac Re	Ac Re	Ac Re	Ac Re	Ac Re
A	2	↓	↓	↓	↓	↓	↓	↓	↓	↓	↓	↓	↓	↓	↓	↓	↓	↓	↓	↓	1 2	2 3	5 6	8 9	12 13	18 19	27 28	41 42
B	3	↓	↓	↓	↓	↓	↓	↓	↓	↓	↓	↓	↓	↓	0 1	↓	↓	↓	1 2	2 3	3 4	5 6	8 9	12 13	18 19	27 28	41 42	
C	5	↓	↓	↓	↓	↓	↓	↓	↓	↓	↓	↓	↓	0 1	↓	↓	↓	1 2	2 3	3 4	5 6	8 9	12 13	18 19	27 28	41 42	↑	
D	8	↓	↓	↓	↓	↓	↓	↓	↓	↓	↓	↓	0 1	↓	↓	↓	1 2	2 3	3 4	5 6	8 9	12 13	18 19	27 28	41 42	↑	↑	
E	13	↓	↓	↓	↓	↓	↓	↓	↓	0 1	↓	↓	↓	1 2	2 3	3 4	5 6	8 9	12 13	18 19	↑	↑	↑	↑	↑	↑	↑	↑
F	20	↓	↓	↓	↓	↓	↓	↓	↓	0 1	↓	↓	↓	1 2	2 3	3 4	5 6	8 9	12 13	18 19	↑	↑	↑	↑	↑	↑	↑	↑
G	32	↓	↓	↓	↓	↓	↓	↓	↓	0 1	↓	↓	↓	1 2	2 3	3 4	5 6	8 9	12 13	18 19	↑	↑	↑	↑	↑	↑	↑	↑
H	50	↓	↓	↓	↓	↓	↓	↓	0 1	↓	↓	↓	1 2	2 3	3 4	5 6	8 9	12 13	18 19	↑	↑	↑	↑	↑	↑	↑	↑	↑
J	80	↓	↓	↓	↓	↓	↓	0 1	↓	↓	↓	1 2	2 3	3 4	5 6	8 9	12 13	18 19	↑	↑	↑	↑	↑	↑	↑	↑	↑	↑
K	125	↓	↓	↓	↓	↓	↓	0 1	↓	↓	↓	1 2	2 3	3 4	5 6	8 9	12 13	18 19	↑	↑	↑	↑	↑	↑	↑	↑	↑	↑
L	200	↓	↓	↓	↓	0 1	↓	↓	↑	1 2	2 3	3 4	5 6	8 9	12 13	18 19	↑	↑	↑	↑	↑	↑	↑	↑	↑	↑	↑	↑
M	315	↓	↓	↓	↓	0 1	↓	↓	1 2	2 3	3 4	5 6	8 9	12 13	18 19	↑	↑	↑	↑	↑	↑	↑	↑	↑	↑	↑	↑	↑
N	500	↓	↓	↓	0 1	↓	↓	1 2	2 3	3 4	5 6	8 9	12 13	18 19	↑	↑	↑	↑	↑	↑	↑	↑	↑	↑	↑	↑	↑	↑
P	800	↓	↓	0 1	↓	↓	1 2	2 3	3 4	5 6	8 9	12 13	18 19	↑	↑	↑	↑	↑	↑	↑	↑	↑	↑	↑	↑	↑	↑	↑
Q	1,250	↓	0 1	↓	↓	1 2	2 3	3 4	5 6	8 9	12 13	18 19	↑	↑	↑	↑	↑	↑	↑	↑	↑	↑	↑	↑	↑	↑	↑	↑
R	2,000	0 1	↑	↓	1 2	2 3	3 4	5 6	8 9	12 13	18 19	↑	↑	↑	↑	↑	↑	↑	↑	↑	↑	↑	↑	↑	↑	↑	↑	↑
S	3,150			1 2																								

↓ = Use first sampling plan below arrow. If sample size equals or exceeds, lot or batch size, carry out 100 % inspection.

↑ = Use first sampling plan above arrow.

Ac = Acceptance number, Re = Rejection number

Table II-C - Single sampling plans for reduced inspection

Acceptable quality levels (reduced inspection)†

sample size code letter	sample size	.010	.015	.020	.040	.060	.10	.15	.25	.40	.65	1.0	1.5	2.5	4.0	6.5	10	15	25	40	65	100	150	250	400	650	1000	
		Ac Re	Ac Re	Ac Re	Ac Re	Ac Re	Ac Re	Ac Re	Ac Re	Ac Re	Ac Re	Ac Re	Ac Re	Ac Re	Ac Re	Ac Re	Ac Re	Ac Re	Ac Re	Ac Re	Ac Re	Ac Re	Ac Re	Ac Re	Ac Re	Ac Re	Ac Re	
A	2	↓	↓	↓	↓	↓	↓	↓	↓	↓	↓	↓	↓	↓	↓	0 1	↓	↓	1 2	2 3	3 4	5 6	7 8	10 14	14 21	21 30	30 31	
B	2	↓	↓	↓	↓	↓	↓	↓	↓	↓	↓	↓	↓	↓	0 1	↓	↓	↓	1 2	2 3	3 4	5 6	7 8	10 14	14 21	21 30	30 31	
C	2	↓	↓	↓	↓	↓	↓	↓	↓	↓	↓	↓	↓	0 1	↑	↑	0 1	1 2	1 2	1 2	2 3	3 4	4 5	5 6	7 8	10 14	14 21	21 30
D	3	↓	↓	↓	↓	↓	↓	↓	↓	↓	↓	↓	0 1	↑	↑	↓	0 1	1 2	1 2	2 3	3 4	4 5	5 6	7 8	10 14	14 21	21 30	30 31
E	5	↓	↓	↓	↓	↓	↓	↓	↓	↓	↓	0 1	↑	↑	0 1	2 3	2 3	3 4	3 4	4 5	5 6	6 7	7 8	10 14	14 21	21 30	30 31	
F	8	↓	↓	↓	↓	↓	↓	↓	↓	↓	0 1	↑	↑	0 1	2 3	2 3	3 4	3 4	4 5	5 6	6 7	7 8	10 14	14 21	21 30	30 31	↑	
G	13	↓	↓	↓	↓	↓	↓	↓	↓	0 1	↑	↑	0 1	2 3	2 3	3 4	3 4	4 5	5 6	6 7	7 8	10 14	14 21	21 30	30 31	↑	↑	
H	20	↓	↓	↓	↓	↓	↓	0 1	↑	↑	0 1	2 3	2 3	3 4	3 4	4 5	5 6	6 7	7 8	8 9	10 14	14 21	21 30	30 31	↑	↑	↑	
J	32	↓	↓	↓	↓	↓	0 1	↑	↑	0 1	2 3	2 3	3 4	3 4	4 5	5 6	6 7	7 8	8 9	10 14	14 21	21 30	30 31	↑	↑	↑	↑	
K	50	↓	↓	↓	↓	↓	0 1	↑	↑	0 1	2 3	2 3	3 4	3 4	4 5	5 6	6 7	7 8	8 9	10 14	14 21	21 30	30 31	↑	↑	↑	↑	
L	80	↓	↓	↓	↓	0 1	↑	↑	0 1	2 3	2 3	3 4	3 4	4 5	5 6	6 7	7 8	8 9	10 14	14 21	21 30	30 31	↑	↑	↑	↑	↑	
M	125	↓	↓	↓	0 1	↑	↑	0 1	2 3	2 3	3 4	3 4	4 5	5 6	6 7	7 8	8 9	10 14	14 21	21 30	30 31	↑	↑	↑	↑	↑	↑	
N	200	↓	↓	0 1	↑	↑	0 1	2 3	2 3	3 4	3 4	4 5	5 6	6 7	7 8	8 9	10 14	14 21	21 30	30 31	↑	↑	↑	↑	↑	↑	↑	
P	315	↓	0 1	↑	↑	0 1	2 3	2 3	3 4	3 4	4 5	5 6	6 7	7 8	8 9	10 14	14 21	21 30	30 31	↑	↑	↑	↑	↑	↑	↑	↑	
Q	500	0 1	↑	↑	0 1	↑	2 3	2 3	3 4	3 4	4 5	5 6	6 7	7 8	8 9	10 14	14 21	21 30	30 31	↑	↑	↑	↑	↑	↑	↑	↑	
R	800	↑	↑	0 2	1 3	1 4	2 5	3 6	4 8	5 10	6 13	7 13	8 13	9 13	10 13	11 13	12 13	13 13	14 13	15 13	16 13	17 13	18 13	19 13	20 13	21 13	22 13	

↓ = Use first sampling plan below arrow. If sample size equals or exceeds, lot or batch size, carry out 100 % inspection.

↑ = Use first sampling plan above arrow, Ac = Acceptance number, Re = Rejection number

† = If the acceptance number has been exceeded, but the rejection number has not been reached, accept the lot, but revert to normal inspection (see 11.1.4).

**Table II-D - Limit numbers for reduced inspection**

Acceptable quality levels (reduced inspection)†

Number of units sampled in last 10 lots	AQL 0.1	AQL 0.25	AQL 1.0	AQL 2.5	AQL 4.0	AQL 10.0
20 to 29	*	*	*	*	*	0
30 to 49	*	*	*	*	*	0
50 to 79	*	*	*	*	0	2
80 to 129	*	*	*	*	0	4
130 to 199	*	*	*	0	2	7
200 to 319	*	*	0	2	4	14
320 to 499	*	*	0	4	8	24
500 to 799	*	*	2	7	14	40
800 to 1,249	*	0	4	14	24	68
1,250 to 1,999	*	0	7	24	40	110
2,000 to 3,149	0	2	14	40	68	181
3,150 to 4,999	0	4	24	67	111	
5,000 to 7,999	2	7	40	110	181	
8,000 to 12,499	4	14	68	181		
12,500 to 19,999	4	24	110			
20,000 to 31,499	14	40	181			
31,500 to 49,999	24	67	68	181		
50,000 over	40	110				

\* Denotes the number of sample units from the last ten lots is not sufficient for reduced inspection for this AQL.

In this case more than 10 lots must be used for the calculation provided that the lots used are the most recent ones in sequence. Of course all were subject to normal inspection and none were rejected while on inspection.

In some cases a rejected lot is not sent back to the supplier but is instead subject to 100% inspection and all nonconforming units are replaced by conforming units. In this case the average outgoing quality -  $AOQ$  - given the process average is  $p\%$ , is the average quality of the outgoing product. This includes all accepted lots, plus all lots which were not initially accepted and from which all nonconforming units were replaced by conforming units. Clearly  $AOQ(p\%) = OC(p\%) \cdot (p\%)$  since a proportion  $(1 - OC(p\%))$  of outgoing product has no nonconforming units. If, in fact, rejected lots are repaired then the value of the  $AOQ$  at the  $AQL$  is a useful parameter when originally negotiating the  $AQL$  since it represents the true proportion of nonconforming units arriving on the factory floor. Another useful parameter, when lots are repaired, is the Average Outgoing Quality Limit -  $AOQL$ . The  $AOQL$  is the maximum of the  $AOQ$ 's for all possible process averages; i.e.  $AOQL = \max\{OC(p\%) \cdot (p\%) | 0 \leq p\% \leq 100\%\}$ . This is the worst case scenario for measuring the true proportion of nonconforming units arriving on the factory floor.

The  $AOQ$  associated with the sample size and sampling limits in Table II-B, Table II-C and Table II-D was calculated by computer simulations. In the exercises we suggest some term projects which illustrate just how to go about analyzing quality control schemes by simulation. It is not, however, our goal to understand the precise workings of this or any other quality control procedures through simulation but rather to develop mathematical tools for the analysis of quality control schemes. Our credo is that one theorem is worth a thousand simulations!

## 1.4 Exercises

The following projects may be assigned at the beginning of term. Students should form teams. It is preferable that each team have at least one member with computer experience. The main mathematical work involves concepts in Chapter 5 but the simulation part can be started immediately.

**Exercise 1.1** [ATM buffer management] We shall consider a simple  $2 \times 2$  ATM multiplexor. Two input trunk lines carrying noisy ATM traffic enter the switch at input ports A and B and leave from ports X and Y. The cells from input port A that exit from port X are stored in buffer AX. Those from input port B that exit from port X are stored in buffer BX. The cells from input port A that exit from port Y are stored in buffer AY. Those from input port B that exit from port Y are stored in buffer BY. All four buffers have a maximum capacity of 5 cells and excess cells are lost.

Every time slot the controller at output port X performs a round robin polling of the two buffers AX and BX. The head-of-line cell is sent from one queue and then the other. If no cell is queued at the polled buffer the second buffer is immediately polled. If it is also empty then the pointer returns to the first buffer polled. We assume the arrivals at buffers AX and BX form independent Bernoulli processes

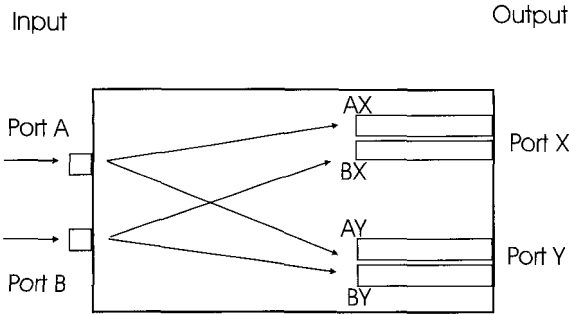

Fig. 1.5 A two by two switch

with probabilities  $p_A$  and  $p_B$  of having a cell in a given time slot.

- Model the queue size AX and BX plus a controller pointer as a Markov chain. Write a *Mathematica* program to calculate the  $(72 \times 72)$  transition matrix  $K$ . Calculate the cell loss probability of cells traversing output port X using  $K$ .
- Write a computer simulation of output port X and estimate the cell loss probability. Compare with the results in a).
- Is it possible to use another buffer management protocol other than round robin which gives a smaller cell loss probability? Make a suggestion and calculate the new cell loss probability (analytically if possible but in any case by simulation). Suggestions: Serve the Longest Queue or Serve the Oldest Cell. Discuss the disadvantages of the new protocol.
- Discuss the difficulties of evaluating a  $16 \times 16$  ATM switch.

Note that if  $p_A + p_B > 1$  then on average more cells arrive than can be served. This means the buffers will tend to be overloaded and lots of cells will be lost. When  $p_A + p_B$  is small however cell losses will be small. It is suggested that the simulations be done for a variety of values of  $p_A$  and  $p_B$  to get an overall picture.

### Exercise 1.2 [ATM buffer management continued]

- Find the mean time until the first cell is lost given the buffers start out empty.
- Calculate the mean busy period which is the mean time for an empty system to become empty again.
- Calculate the mean delay experienced by a cell which passes through buffer A.
- Calculate the mean delay for buffer B. Use Little's law (see Chapter 6).
- Use the simulator already developed to obtain estimates for the performance measures calculated analytically in a), b) and c). Note that the Little's law applies to cells that are queued in the system not those that are discarded so Little's law fails when the buffer is overloaded, i.e.  $p_A + p_B > 1$ .

### Exercise 1.3 [On-line Quality Control]

- Imagine you are to receive batches of 1000 items every week. Design a sampling acceptance scheme based on MIL-STD-105D (ISO 2859) which for an AQL of 2.5%.

- b) Write a simulation for this acceptance sampling scheme. Check that the AQL of 2.5% is indeed the highest percentage of defectives acceptable as a process average. Estimate the percentage of lots rejected if this average is maintained. Next experiment to find the lot tolerance percent defective LTPD specified by this scheme. The LTPD is usually taken to be that incoming quality above which there is less than a 10% chance a lot will be accepted.
- c) Suppose now that you are the manufacturer producing the above items. Suppose long experience has taught that a 1% rate of defective items is inevitable without an expensive redesign of the plan. To monitor production a item is selected at random out of every 10 items produced. Once 5 items have been selected, the items are inspected for defects. Design a Shewhart  $p$ -chart (see Example 3.27) to monitor that production is in control with a 1% rate of defectives. What is the distribution of the number of items produced before a false alarm is signaled.
- d) Suppose that at some point in the future the process goes out of control and the rate of defectives increases to 5%. What is the distribution of the number of items produced after this change point before an out of control alarm is signaled.
- e) Write a simulation to design a Cusum procedure (see Example 5.39) based on the lengths of runs of nondefective items inspected between occurrences of defective items. Set the on-target run length to be the same as for the  $p$ -chart.
- f) Design the anchor value to minimize the mean time to signal an out of control situation if indeed the rate of defectives suddenly jumps to 5%.
- g) The above Cusum procedure can be modelled by a Markov chain with forbidden out of control states. Use *Mathematica* to calculate the expected on-target and off-target run lengths of the procedure you have designed and check that these agree with simulation results.

## 1.5 A Probability Primer

We describe the **equiprobable** model associated with an example in data transmission. Imagine that data is generated in one, five or ten kilobit packets. On average one kilobit packets are three times more likely than ten kilobit packets and five kilobit packets are four times as likely as ten kilobit packets. Of course the transmissions might be strictly deterministic. It might be that the pattern of transmissions is always 5, 1, 5, 1, 5, 1, 5, 10 kilobit packets repeated over and over. This *deterministic model* certainly describes the average flow of bytes across the network but it misses an essential component. Suppose a node in the network receives and retransmits the packets and at all times stores the last three packets. Suppose the capacity of the node is 25 kilobits. The deterministic flow poses no problem since at the worst the node must store 20 kilobits. The problem of congestion occurs when the packets arrive in random order and in this case the node might need a capacity of 30 kilobits.

Suppose we wish to describe the outcome of ten consecutive transmissions with a random arrival of packets. We do a thought experiment. Consider the experiment of drawing ten times with replacement from a bag containing three pennies (each penny represents a one kilobit packet), four nickels (each nickel represents a five kilobit packet) and a dime (representing a ten kilobit packet). Each of the eight coins is assumed to have an equal chance of being picked in any given draw. This is the model of random or probability sampling. The probabilist's job is to describe the likelihood of possible outcomes of this sampling procedure given the contents of the bag. The statistician's job is much harder since he is not told the contents of the bag and must infer its contents from the sample. In other words the probabilist usually knows the distribution of the values of the coins.

The *outcome of such an experiment is random or stochastic* since it can't be predicted. If we put imaginary numbers on the three pennies and the four nickels we get a list or population

$$\mathcal{L} := \{p_1, p_2, p_3, n_1, n_2, n_3, n_4, d\}$$

of possible equally likely outcomes from a single draw. We are only interested in a single aspect of each element of this population; namely the monetary value. The distribution of any aspect of a population is often represented by the mass function which is simply a function  $p$  giving the proportion  $p(x)$  of the population having value  $x$ . In this case,  $p$  is given by the proportions of the number of pennies, nickels and dimes:

$$\begin{array}{l} x : 1 \quad 5 \quad 10 \quad \text{otherwise} \\ p(x) : \frac{3}{8} \quad \frac{4}{8} \quad \frac{1}{8} \quad 0 \end{array}$$

We often summarize this information in the population histogram as shown in Figure 1.6.

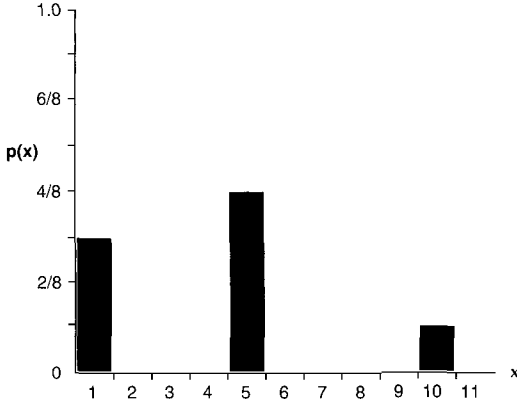

Fig. 1.6 The population histogram

The mean  $\mu$  of the population is just the average value of the population which is

$$\mu = (1 + 1 + 1 + 5 + 5 + 5 + 5 + 10)/8 = 33/8.$$

We remark that this is just  $\sum xp(x)$ . The variance of the population  $\sigma^2$  is the average squared deviation of the population values from the population average:

$$\begin{aligned} \sigma^2 &= \frac{3(1 - \mu)^2 + 4(5 - \mu)^2 + (10 - \mu)^2}{8} \\ &= \sum (x - \mu)^2 p(x) = 8.359375. \end{aligned}$$

The mean is a kind of center of the population histogram. The standard deviation  $\sigma$  is a measure of the spread. If, in general, the aspect values of the elements of the population are a list of numbers  $(s_1, s_2, \dots, s_N)$  (instead of  $(1, 1, 1, 5, 5, 5, 5, 10)$ ), we could again construct the population histogram and the corresponding population mass function  $p$ . In general,

$$\mu = \sum_{i=1}^N s_i/N = \sum_x xp(x) \text{ and } \sigma^2 = \sum_{i=1}^N (s_i - \mu)^2/N = \sum_x (x - \mu)^2 p(x).$$

Chebyshev's lemma provides a precise description of the spread of values around the mean of the list:

**Lemma 1.1** *The proportion of the values in a list lying at least  $k$  standard deviations from the mean is less than  $1/k^2$  for any  $k > 0$ .*

**Proof:** Those elements of the list of values lying at least  $k$  standard deviations from the mean may be written as  $F := (s : |s - \mu| \geq k \cdot \sigma)$ . The proportion of



elements in the list in  $F$  is  $\sharp(F)/N$  where  $\sharp(F)$  denotes the number of elements in  $F$ . Now by definition

$$\begin{aligned}\sigma^2 &= \frac{\sum_{i=1}^N (s_i - \mu)^2}{N} \geq \frac{\sum_{s_i \in F} (s_i - \mu)^2}{N} \\ &\geq \frac{\sum_{s_i \in F} (k\sigma)^2}{N} \\ &= k^2 \sigma^2 \frac{\sharp(F)}{N}.\end{aligned}$$

Now divide through by  $k^2 \sigma^2$  and we have  $\sharp(F)/N \leq 1/k^2$  as desired. ■

Applying Chebyshev's lemma to the above population we get that the proportion of the population lying at least 2 standard deviations from the mean  $\mu = 33/8 = 4.125$  is less than  $1/4$ . Since  $\sigma = 2.8912$  approximately, we see  $\mu + 2\sigma = 9.9075$  hence only the value 10 lies this far from the mean. The element 10 represents only  $1/8$  of the list so the inequality is verified.

Now suppose we wish to describe 10 draws from  $\mathcal{L}$ . A list of all possible outcomes is called the sample space and is described by

$$\Omega = \{\omega = (x_1, x_2, \dots, x_{10}) : x_i \in \mathcal{L}; i = 1, 2, \dots, 10\}$$

where  $\omega$  is used to denote a typical outcome or sample point and  $p_1$  denotes the first penny,  $p_2$  the second and so on. One particular sample point might be

$$\omega_0 = (p_1, d, p_2, n_2, d, p_1, p_3, n_4, n_2, n_3).$$

This corresponds to first drawing penny number 1 then the dime and then penny number 2 and so on up to nickel number 3 on tenth draw. Later we will call  $\Omega$  a product space and we will use the notation

$$\Omega = \{p_1, p_2, p_3, n_1, n_2, n_3, n_4, d\}^{10} = \mathcal{L}^{10}.$$

By symmetry each outcome is equally likely. The number of points in  $\Omega$  is  $\sharp(\Omega) = 8^{10}$  since each of the 10 draws could be one element of the 8 element set  $\mathcal{L}$ . Hence, intuitively, the probability of each sample point is  $8^{-10}$ . The probability of an event of interest like the probability of getting at least one dime is clearly proportional to the number of sample points in the event. Let  $A$  represent the event or subset of  $\Omega$  corresponding to getting at least one dime. The sample point  $\omega_0$ , for instance, is in  $A$ . Let  $P(A)$  denote the probability that the outcome of the random experiment falls in the event  $A$ ; so

$$P(A) = \frac{\sharp(A)}{\sharp(\Omega)}.$$

For equiprobable models such as this one, calculating probabilities reduces to counting. This is the reason we chose the sample space  $\Omega$  above. If, instead, we had chosen  $\Omega = \{p, n, d\}^{10}$  we would not have an equiprobable model and the construction of

the appropriate  $P$  to describe random drawing requires more care (see the product probability in Chapter 2).

Counting is not so easy! We shall assume everybody knows permutations and combinations but it is not immediately clear how to easily calculate the probability of getting at least one dime. It is useful to develop a series of axioms about probabilities to make things easier. This will be done systematically in Chapter 2.

First,  $P(\Omega) = 1$ . Next, if two events  $A$  and  $B$  are disjoint, that is they have no elements in common, then the probability of their union is the sum of their probabilities, i.e.  $P(A \cup B) = P(A) + P(B)$ . This follows since

$$\begin{aligned} P(A \cup B) &= \frac{\#(A \cup B)}{\#(\Omega)} = \frac{\#(A) + \#(B)}{\#(\Omega)} = \frac{\#(A)}{\#(\Omega)} + \frac{\#(B)}{\#(\Omega)} \\ &= P(A) + P(B). \end{aligned}$$

The complement of  $A$ , i.e. those points which are not in  $A$ , is denoted by  $A'$ .  $A'$  has probability  $P(A') = 1 - P(A)$ . This follows immediately from the fact that  $1 = P(\Omega) = P(A + A') = P(A) + P(A')$  since  $A$  and  $A'$  are disjoint. Consequently, if  $A'$  represents the event where no dimes are drawn then  $P(A) = 1 - (7/8)^{10}$  since the number of sample points in  $A'$  is  $7^{10}$  (each draw can be chosen from  $\{p_1, p_2, p_3, n_1, n_2, n_3, n_4\}$ ).

The intuitive use of conditional probabilities is what separates probabilists from measure theorists. If, in our example, we know that the event  $B$  of drawing exactly 3 dimes has occurred (or exactly 3 ten kilobit packets have arrived among the last 10 packets), what is the probability of the event  $C$  that we draw 3 dimes in a row (or equivalently, that the node is overloaded by 3 ten kilobit packets in a row)? By symmetry, the probability that an outcome in  $C$  occurs given that  $B$  has occurred is the proportion of the number of sample points in both  $B$  and  $C$  divided by the number in  $B$ ; that is we define the conditional probability of  $C$  given  $B$  to be

$$P(C|B) = \frac{\#(B \cap C)}{\#(B)} = \frac{\#(B \cap C)/\#(\Omega)}{\#(B)/\#(\Omega)} = \frac{P(B \cap C)}{P(B)}.$$

If we work this out we see  $\#(B)$  is the number of ways of choosing exactly 3 dimes from the 10 draws times the number of ways of drawing each of the remaining 7 coins from  $\{p_1, p_2, p_3, n_1, n_2, n_3, n_4\}$ . Hence,

$$\#(B) = \binom{10}{3} \times 7^7 \text{ so } P(B) = \binom{10}{3} \left(\frac{1}{8}\right)^3 \left(\frac{7}{8}\right)^7.$$

Similarly  $\#(B \cap C)$  is the number of ways of choosing 3 consecutive draws to be dimes; that is 8 ways times  $7^7$ , the number of ways of drawing each of the remaining 7 coins from  $\{p_1, p_2, p_3, n_1, n_2, n_3, n_4\}$ . Hence,  $\#(B \cap C) = 8 \times 7^7$ . We conclude

$$P(C|B) = 8 / \binom{10}{3} = \frac{1}{15}.$$

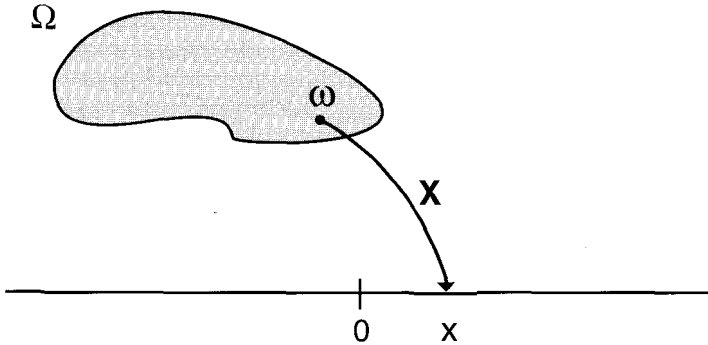

Fig. 1.7 A random variable

The idea of independence is obvious. We say an event  $F$  is independent of an event  $E$  if the probability that  $F$  will occur is independent of knowing whether  $E$  occurred or not; that is  $P(F|E) = P(F)$ . Multiplying by  $P(E)$  and using the definition  $P(F|E) := P(E \cap F)/P(E)$ , we see this is equivalent to  $P(E \cap F) = P(E) \cdot P(F)$ . In particular if  $E$  is the event that the first coin is a nickel and  $F$  is the event that the second coin is a dime then clearly we have independent events and this can be checked by calculation.

## 1.6 A Random Sample

Let  $X_1, \dots, X_{10}$  represent the values of the coins drawn (or packets transmitted) during the first, through tenth draws. These *random variables* are defined on the sample space  $\Omega$ . For the sample point  $\omega_0 = (p_1, d, p_2, n_2, d, p_1, p_3, n_4, n_2, n_3)$ ,  $X_1(\omega_0) = 1, X_2(\omega_0) = 10, X_3(\omega_0) = 1$  and so on. In general a random variable calculates some aspect of a sample point. For instance we might define  $X$  to be the total number of dimes drawn so  $X(\omega_0) = 2$ . Figure 1.7 illustrates a random variable  $X$  defined at each point  $\omega$  of a sample space.

The description of a random variable starts with the range,  $\mathcal{R}_X$ , of values taken on. For instance  $\mathcal{R}_X = \{0, 1, 2, \dots, 10\}$ . Next we specify the likelihood of these values by constructing the histogram of the list of values  $X(\omega)$  for  $\omega \in \Omega$ . Since this list has  $8^{10}$  elements this might seem difficult but when we group  $\omega$ 's giving the same  $X$  value we see the histogram is equivalent to the probability mass function or p.m.f.

$$p_X(x) := P(\{\omega : X(\omega) = x\}) \equiv P(X = x), \text{ for } x \in \mathcal{R}_X.$$

For instance,  $p_X(3)$  is the probability precisely three dimes are drawn and this has

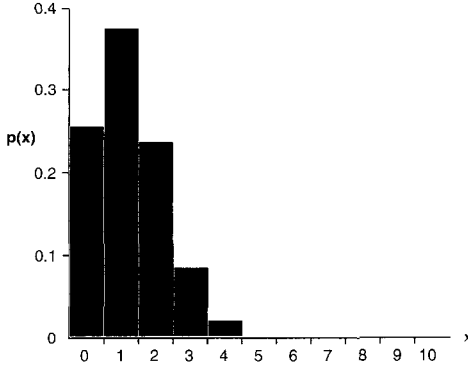

Fig. 1.8 The histogram of X

been calculated above. By the same reasoning we can get

$$p_X(x) = \binom{10}{x} \left(\frac{1}{8}\right)^x \left(\frac{7}{8}\right)^{10-x} \text{ for } x \in \{0, 1, \dots, 10\}.$$

This is a binomial distribution investigated more thoroughly later. The histogram of the random variable X is given in Figure 1.8.

The p.m.f of  $X_1$  is obviously

$$p_{X_1}(x) = \begin{cases} \frac{3}{8} & x = 1 \\ \frac{4}{8} & x = 5 \\ \frac{1}{8} & x = 10 \\ 0 & \text{otherwise} \end{cases}$$

Formally we may get these probabilities by counting. Recall that we denote an arbitrary point  $(x_1, x_2, \dots, x_{10}) \in \Omega$  by  $\omega$ . Hence

$$\begin{aligned} P(X_1 = 5) &= P(\{\omega : x_1 \in \{n_1, n_2, n_3, n_4\}, x_i \in \mathcal{L}; i = 2, \dots, 10\}) \\ &= \#(\{\omega : x_1 \in \{n_1, n_2, n_3, n_4\}, x_i \in \mathcal{L}; i = 2, \dots, 10\}) / \#(\Omega) \\ &= 4 \times 8 \times 8 \times \dots \times 8 / 8^{10} \\ &= 4/8. \end{aligned}$$

By similar reasoning we see the p.m.f.'s of  $X_1, X_2, \dots, X_{10}$  are all the same and are equal to the p.m.f. of the population  $p$ . This is the link between the real and perhaps unknown (to the statistician) distribution of the population and the sample which we observe. Each of the sampled values represents the population in the sense that its distribution or p.m.f. is that of the population.

The sequence of random variables  $X_1, X_2, \dots, X_{10}$  is an *i.i.d.* sequence; that is the random variables are independent and identically distributed where we say random variables are independent if events generated by the individual  $X_i$ 's are independent in the sense given above. To be more precise we let  $\sigma(X_i)$  be the collection of events in  $\Omega$  of the form  $\{X_i \in H_i\}$  where  $H_i$  is some subset of real numbers  $\mathcal{R}$ . For instance take  $H_1 = \{5\}$ . Then the event  $\{X_1 \in H_1\} \equiv \{\omega :$

$X_1(\omega) = 5$  is the set investigated above. The event of drawing a nickel on the first draw is therefore in  $\sigma(X_1)$ . Similarly, taking  $H_1 = \{1, 10\}$ , we see that the event of not drawing a nickel on the first draw is also in  $\sigma(X_1)$ . If we let  $H_2 = \{10\}$  then

$$\begin{aligned} \{X_2 \in H_2\} &= \{\omega = (x_1, x_2, \dots, x_{10}) : X_2(\omega) = 10\} \\ &= \{\omega : x_2 = d, x_i \in \mathcal{L}; i = 1, 3, 4, \dots, 10\} \end{aligned}$$

is in  $\sigma(X_2)$ . Clearly  $P(X_2 \in H_2) = 1/8$ . Moreover

$$\begin{aligned} &P(\{X_1 \in H_1\} \cap \{X_2 \in H_2\}) \\ &= P(\{\omega : x_1 \in \{n_1, n_2, n_3, n_4\}, x_2 = d, x_i \in \mathcal{L}; i \geq 3\}) \\ &= \frac{4 \times 1 \times 8 \times \dots \times 8}{8 \times 8 \times 8 \times \dots \times 8} \\ &= \frac{4}{8} \cdot \frac{1}{8} \\ &= P(X_1 \in H_1) \cdot P(X_2 \in H_2). \end{aligned}$$

This is the formal proof that the event of drawing a nickel on the first draw and a dime on the second are independent. It is clear that any events of the form  $\{X_1 \in H_1\}$  and  $\{X_2 \in H_2\}$  are independent by the same reasoning and we therefore declare the random variables  $X_1$  and  $X_2$  to be independent. By the same token we see all the  $X_i$ 's are mutually independent.

We shall need to express the collection of events that are determined by observing a sequence of random variables. Define  $\mathcal{F}_m := \sigma(X_1, X_2, \dots, X_m)$  to be the set of events of the form

$$E = \{\omega : (X_1(\omega), X_2(\omega), \dots, X_m(\omega)) \in H\}$$

where  $H$  is a subset of  $\mathfrak{R}^m$ . This just means we can determine if an  $\omega$  is in  $E$  or not by observing the values of  $X_1(\omega), \dots, X_m(\omega)$ . We call  $\mathcal{F}_m$  the past of the random sequence up to observation or time  $m$ .

The expected value of a random variable is the average of the list of its values:

$$EX \equiv \mu_X := \frac{\sum_{\omega \in \Omega} X(\omega)}{\#\Omega} = \sum_{x \in \mathfrak{R}_X} x p_X(x).$$

The latter equality is obtained by grouping together all those  $\omega$  which are sent to a common value  $x$ ; i.e.  $\{\omega : X(\omega) = x\}$ . Clearly the contribution of these points to the average is just  $x \cdot \#\{\omega : X(\omega) = x\}$ . However  $p_X(x) = P(X = x) = \#\{\omega : X(\omega) = x\} / \#\Omega$  which gives the result. For instance, if  $X$  represents the number of dimes drawn then

$$EX = \sum_{x=0}^{10} x \binom{10}{x} \left(\frac{1}{8}\right)^x \left(\frac{7}{8}\right)^{10-x}.$$

This result had better be  $10/8$  (and it is) since there is one chance in eight of drawing a dime and we draw ten times. The expected value of  $X_1$  is clearly equal to  $\mu = 33/8$  since the histogram of  $X_1$  is the same as that of the population.

The expected value is useful because it measures the center of the histogram of  $X$ . We can also calculate the expected value of the sum  $X + Y$  where  $Y$  is another random variable. By definition

$$\begin{aligned} E(X + Y) &= \frac{\sum_{\omega \in \Omega} (X(\omega) + Y(\omega))}{\#\Omega} = \frac{\sum_{\omega \in \Omega} X(\omega)}{\#\Omega} + \frac{\sum_{\omega \in \Omega} Y(\omega)}{\#\Omega} \\ &= EX + EY. \end{aligned}$$

Also, if  $c$  is a constant value

$$E(cX) = \frac{\sum_{\omega \in \Omega} cX(\omega)}{\#\Omega} = c \frac{\sum_{\omega \in \Omega} X(\omega)}{\#\Omega} = c \cdot EX.$$

This linearity is a very useful property of the expectation. The 50<sup>th</sup> percentile (the median) also measures the center of the histogram of  $X$  but does not have this linearity property so it is much less useful. If  $T$  represents the total value of the ten draws then  $ET = E(X_1 + \dots + X_{10}) = EX_1 + \dots + EX_{10} = 10 \cdot \mu$  again by linearity. Also if  $\bar{X} := (X_1 + \dots + X_{10})/10$  then again by linearity  $E\bar{X} = \mu$ . This means the histogram of the random variable  $\bar{X}$  is centered at the population mean  $\mu$  and  $\bar{X}$  is what we call an *unbiased estimator* of  $\mu$ .

We can make new random variables from old by defining functions of  $X$  like  $h(x) = x^2$  or  $h(x) = \max(x^2, 5)$ . The expectation is still given from the definition:

$$Eh(X) = \frac{\sum_{\omega \in \Omega} h(X(\omega))}{\#\Omega} = \sum_{x \in \mathcal{R}_X} h(x)p_X(x)$$

by again grouping those  $\omega$  which are sent to the same value  $x$ . This expression is called the *law of the unconscious statistician*. For instance, if  $X$  is the number of dimes drawn, then

$$E \max(X^2, 5) = \sum_{x=0}^2 5 \binom{10}{x} \left(\frac{1}{8}\right)^x \left(\frac{7}{8}\right)^{10-x} + \sum_{x=3}^{10} x^2 \binom{10}{x} \left(\frac{1}{8}\right)^x \left(\frac{7}{8}\right)^{10-x}.$$

The most important application of the law of the unconscious statistician is the definition of the variance of a random variable:  $\sigma_X^2 := E(X - \mu_X)^2$ . Since the variance of  $X$  is precisely the variance of the list  $X(\omega)$  we have, by Chebyshev's lemma, that the proportion of this list at least  $k$  standard deviations  $\sigma_X$  from the mean of the list  $\mu_X$  is less than  $1/k^2$ . However the proportion of the list at least  $k$  standard deviations from the mean is precisely  $P(|X - \mu_x| \geq k \cdot \sigma_X)$  so we have Chebyshev's lemma for random variables:

**Lemma 1.2** *For any random variable with expected value  $\mu_X$  and standard deviation  $\sigma_X$  we have  $P(|X - \mu_x| \geq k \cdot \sigma_X) \leq 1/k^2$ .*

## 1.7 Joint Distributions

The joint behavior of random variables and vectors is discussed in detail in Chapter 2 but here let us focus on the simple case of two variables. To be concrete let  $X$  be the number of dimes drawn and let  $T$  be the total value of the coins drawn. The joint p.m.f. is defined to be

$$p_{X,T}(x, t) = P(X = x \text{ and } T = t) = P(\{\omega : X(\omega) = x, T(\omega) = t\})$$

where  $x \in \mathcal{R}_X$  and  $t \in \mathcal{R}_T$ . With this we can repeat most of the calculations done for one variable. In particular, if we create a new random variable such as  $h(X, T)$  where  $h$  is a function like  $h(x, y) = x + 2y$  then we again have a law of the unconscious statistician:

$$Eh(X, T) = \sum_{x \in \mathcal{R}_X, t \in \mathcal{R}_T} h(x, t) p_{X,T}(x, t).$$

This is proved just as before since the expected value is by definition

$$\sum_{\omega \in \Omega} h(X(\omega), Y(\omega)) / \#(\Omega).$$

Calculating the joint p.m.f. could prove to be a lot of work. There are a few short cuts. Define the conditional p.m.f. of  $T$  given  $X$  to be

$$\begin{aligned} p_{T|X}(t|x) &:= P(T = t | X = x) = P(T = t, X = x) / P(X = x) \\ &= p_{X,T}(x, t) / p_X(x). \end{aligned}$$

If we use the law of the unconscious statistician given above we see

$$\begin{aligned} Eh(X, T) &= \sum_{x \in \mathcal{R}_X, t \in \mathcal{R}_T} h(x, t) p_{X,T}(x, t) \\ &= \sum_{x \in \mathcal{R}_X} \left[ \sum_{t \in \mathcal{R}_T} h(x, t) p_{T|X}(t|x) \right] p_X(x) \\ &\equiv \sum_{x \in \mathcal{R}_X} E(h(x, T) | X = x) p_X(x) \end{aligned}$$

where  $E(h(x, T) | X = x)$  denotes the expectation of the random variable  $h(x, T)$  relative to the conditional probability  $P(\cdot | X = x)$ ; that is the probability given by  $P(A | X = x) = P(A \cap \{X = x\}) / P(X = x)$ . Sometimes we can apply our intuition to discover  $p_{T|X}(t|x)$  or perhaps  $E(T | X = x)$ . For instance, if the number of dimes drawn is  $x = 3$  then we know for sure  $T > 30$ . In fact the conditional distribution of  $T$  is the same as drawing 7 times from a similar sack without a dime and adding 30; that is  $30 + \sum_{j=1}^7 Y_j$  where  $Y_j$  denotes the value of the  $j^{\text{th}}$  draw with replacement from a sack containing  $\{p_1, p_2, p_3, n_1, n_2, n_3, n_4\}$ . Clearly  $EY_j = 23/7$  so  $E(T | X = 3) = 30 + 7 \cdot 23/7$ .

In the case of independent variables everything simplifies. If the variables  $X$  and  $Y$  are independent, then the events  $\{X = x\}$  and  $\{Y = y\}$  are independent for any choice of  $x, y$ . Consequently

$$\begin{aligned} p_{X,Y}(x,y) &= P(\{X = x\} \cap \{Y = y\}) \\ &= P(X = x)P(Y = y) \\ &= p_X(x) \cdot p_Y(y); \end{aligned}$$

that is the joint p.m.f. is a product of the one dimensional or marginal p.m.f.'s.

A major bonus is the fact that the expectation of a product of independent variables is the product of the expectations:

$$\begin{aligned} E[X \cdot Y] &= \sum_{x,y} x \cdot y p_{X,Y}(x,y) = \sum_{x,y} x \cdot y p_X(x)p_Y(y) \\ &= \sum_x x p_X(x) \sum_y y p_Y(y) \\ &= EX \cdot EY. \end{aligned}$$

As a corollary, we easily see that the variance of a sum of independent variables is the sum of the variances. This is discussed in Chapter 2 and it bears repeating since this is the essential reason for defining the variance in the first place. In fact, it follows that the variance of  $T = X_1 + \dots + X_{10}$  is the sum of the variances of the components, therefore  $\sigma_T^2 = 10 \cdot \sigma^2$ . Since  $\bar{X} = T/10$  and since

$$\sigma_{T/10}^2 := E(T/10 - \mu_T/10)^2 = \sigma_T^2/10^2 = \sigma^2/10$$

it follows that  $\sigma_{\bar{X}} = \sigma/\sqrt{10}$ . Now apply Chebyshev's Lemma to  $\bar{X}$  with  $k = \epsilon/\sigma_{\bar{X}}$  and remember  $E\bar{X} = \mu$  to get

$$\begin{aligned} P(|\bar{X} - \mu| \geq \epsilon) &= P(|\bar{X} - \mu| \geq (\frac{\epsilon\sqrt{10}}{\sigma} \cdot \sigma/\sqrt{10})) \\ &\leq \frac{\sigma^2}{10\epsilon^2} \end{aligned}$$

where  $\epsilon$  is any small number.

The result for a sample of size  $n$  instead of 10 is

$$P(|\bar{X} - \mu| \geq \epsilon) \leq \sigma^2/(n\epsilon^2).$$

The statistician who doesn't know the contents of the bag uses  $\bar{X}$  as a guess for the mean value of the coins in the bag. We have shown this is an unbiased estimator, but the above shows that if the sample size is large enough,  $\bar{X}$  is probably very close to the population mean  $\mu$ . In fact as  $n \rightarrow \infty$  the probability that the guess misses by more than  $\epsilon$  tends to 0 no matter how small  $\epsilon$  is! Moreover, the statistician can guess the population histogram from the histogram of the sample. The sample histogram is the histogram produced from the list  $X_1(\omega), X_2(\omega), \dots, X_n(\omega)$ . It is equivalent to the sample p.m.f. given by  $p_n(x) := \#(i : X_i(\omega) = x)/n$ ; that is



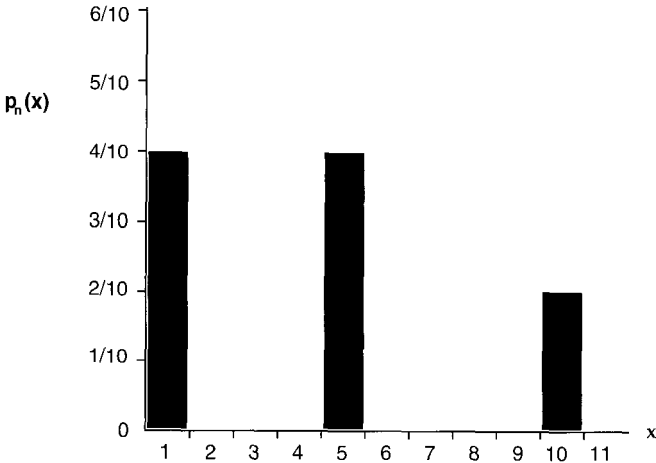

Fig. 1.9 The sample histogram

the proportion of the sample which takes on the value  $x$ . The sample histogram associated with the realization  $\omega_0$  is given in Figure 1.9.

It is reasonable to guess that the sample proportions should be close to the population proportions. If we define the random variables  $e_i$  to be 1 if  $X_i = x$  and 0 otherwise, we have  $p_{e_i}(1) = P(e_i = 1) = p(x)$  and  $p_{e_i}(0) = P(e_i = 0) = 1 - p(x)$ . Moreover  $p_n(x) = \sum_{i=1}^n e_i/n$  so  $E p_n(x) = (E e_1 + \dots + E e_n)/n = E e_1$ . However

$$E e_1 = 1 \cdot P(X_i = x) + 0 \cdot P(X_i \neq x) = p(x)$$

so  $p_n(x)$  is an unbiased estimator of the population proportion. Also the variance of  $p_n(x)$ , by the argument used above for  $\bar{X}$ , is  $\sigma_{e_1}^2/n$ . However  $\sigma_{e_1}^2 = (1 - p(x))^2 p(x) + (0 - p(x))^2 (1 - p(x)) = p(x)(1 - p(x))$  so we conclude the variance of  $p_n(x)$  is  $p(x)(1 - p(x))/n$  which tends to 0 as  $n \rightarrow \infty$ . Using Chebyshev's lemma as above, we conclude that for  $n$  large enough, the probability the sample proportion  $p_n(x)$  differs from the population proportion  $p(x)$  by more than  $\epsilon$  is vanishingly small.

This is the basis of statistical inference! Since the histogram of the sample is close to the population histogram for large  $n$ , any population parameter may be estimated by the corresponding sample parameter. The population mean  $\mu$  may be estimated by the sample mean  $\bar{X}$ ; the percentiles of the population histogram may be estimated by the sample percentiles and so on. We shall assume throughout this text that the hard work of estimating the parameters of our models has been done by somebody else, but in the real world that somebody might be you!

Even beyond the question of estimating parameters is the larger question; is the model appropriate? The arrival of packets at a node is probably not a deterministic string nicely planned to be in repeat patterns of 5, 1, 5, 1, 5, 1, 5, 10 kilobit packets. Neither are the arrivals likely to be as random as drawing with replacement from a

sack. The truth will lie somewhere in between. At best we can calculate the level of congestion associated with different models of the arrival process and make a reasonable compromise in designing the system.

## 1.8 Exercises

Exercise 1.1 There are 6 horses in a race. What is the probability we can correctly predict the horses that win, place and show if we pick 3 of the six horses at random?

Exercise 1.2 Let  $E$ ,  $F$ , and  $G$  be three events. Express the following events in symbolic notation.

- At least one event occurs.
- None of these events occur.
- At most one of these events occurs.
- $G$  occurs but not  $E$  or  $F$ .
- All three events occur.
- At most two of these events occur.

Exercise 1.3 For the counting or equiprobable model introduced in this chapter show that  $P(E \cup F) \leq P(E) + P(F)$  for all events  $E$  and  $F$ .

Exercise 1.4 What is the chance of dealing a poker hand with four kings?

Exercise 1.5 Your probability class has  $n$  students. What is the probability that two or more students have the same birthday.

Exercise 1.6 Genetic theory says that the sex of a child is male or female with equal probability. We take a random sample of 100 families with two children.

- Construct a sample space which will describe the possible outcomes.
- How many points are in this sample space?
- Let  $X_i; i = 1, \dots, 100$  be random variables which denote the number of girls in each of the sample families. Sketch a likely sample histogram.
- What is the approximate mean and standard deviation of this sample histogram?

Exercise 1.7 A student is writing a multiple choice exam containing 6 questions. Each question has 6 possible responses, exactly one of which is correct. The student has spent the semester partying, and has no idea what the correct answers are. He selects answers at random from the 6 alternatives. What is the probability that he will pass the test (i.e. give 3 or more correct answers)?

Exercise 1.8 Suppose ten percent of Ford Escorts have defective head gaskets. What is the approximate probability that a dealer who buys 7 Escorts has no defective head gaskets among the 7?

Exercise 1.9 A production line produces bearings. Each bearing has a probability of 0.13 of being defective. We shall assume defects occur independently among the bearings.

- a) A lot contains 13 bearings. Find the probability that this lot contains more than 2 defective bearings.
- b) The production line has been in production since 8 a.m. If a bearing is produced each minute, how long would one expect to wait until the first defective bearing is produced?

Exercise 1.10 Below are the descriptive statistics of the weights of 2000 sacks of potatoes selected at random by the quality control department. The associated histogram has two bumps because there are two filling machines filling these sacks to a nominal weight of 5 kilograms. One underfills the sacks and one overfills the sacks so the histogram is really the superposition of two histograms and hence has two bumps. Shipments are made in lots of 100 sacks on a skid (you can assume the fill weights are independent).

Variable	N	Mean	Median	TrMean	StDev	SE Mean
C1	2000	4.9961	4.9916	4.9969	0.5496	0.0123

Variable	Minimum	Maximum	Q1	Q3
C1	3.6911	6.1061	4.4998	5.4880

Answer the questions in brackets below:

- a) If a buyer takes a lot at random and makes a histogram of the weights of the individual sacks then this histogram will follow the normal curve (yes or no).
- b) The average of this sample will be approximately (number).
- c) The standard deviation of this sample histogram will be (number).
- The buyer is really concerned about the total weight on a skid. Suppose he takes 75 skids at random and makes a histogram of the total weight of the sacks on each of the 75 skids then
- d) this histogram will necessarily follow a normal curve (yes or no).
- e) The expected value of this sample histogram will be approximately (number).
- f) The standard deviation of this sample histogram will be (number).
- g) What proportion of skids have a total net weight greater than 400 kilograms (number)?
- h) What is the  $10^{th}$  percentile of the total net weight on the skids (number)?

Exercise 1.11 Your company buys 70% of its light bulbs from supplier A, 20% from supplier B and 10% from supplier C. Past data has shown that 5% of the bulbs supplied by A are defective, that 3% of those supplied by B are defective and that 20% of those supplied by C are defective (company C belongs to the owner's brother-in-law).

- a) A light bulb is chosen at random from your stock. What is the probability that the bulb is defective?
- b) Given that the bulb chosen was in fact defective, find the probability that it

came from your brother-in-law's company.

**Exercise 1.12** Past experience has shown that the parts of supplier A are just as likely to be defective as those of supplier B but those of supplier C are 3 times more likely to be defective. Purchasing records show that we have bought 20% of our parts from A, 50% from B and 30% from C. An article has been returned because of a faulty part. What is the probability that the part came from supplier A?

**Exercise 1.13** If we take a sample of size 1,000 from a population with mean 1 and variance 16, what is the probability  $|\bar{X} - 1|$  is greater than 0.5?

**Exercise 1.14** Suppose 30 packets are stored at a DataPac node. These packets are randomly distributed according to the distribution of Figure 1.6. Give an upper bound on the probability that more than 235 kilobytes of storage will be required.

## Chapter 2

# Modelling a Stochastic Process

### 2.1 The Probability Space

The equiprobable model discussed in the probability primer is quite limiting. How, for instance, could we represent the experiment of throwing a weighted coin which has a probability of  $1/\sqrt{2}$  of coming up heads? We would have to draw from a box containing an infinite number of 0's and 1's. Clearly we need a model allowing different probabilities to be associated with different sample points so let's begin afresh with a more general model. As before, the description of an experiment with unpredictable or stochastic outcomes starts with a list or set of all possible *outcomes*. We call this set the *sample space* and denote it by  $\Omega$ . Each outcome is represented by an element of this sample space and this sample point is denoted by  $\omega$ . Consider the following examples:

#### Example 2.1 Toss a coin then a die

An appropriate sample space might be

$$\begin{aligned}\Omega &= \{h, t\} \times \{1, 2, 3, 4, 5, 6\} \\ &= \{(h, 1), (h, 2), \dots, (h, 6), (t, 1), (t, 2), \dots, (t, 6)\}\end{aligned}$$

where  $h$  denotes heads and  $t$  denotes tails.

---

#### Example 2.2 Draw balls from an urn

Suppose an urn contains two red balls, one white ball and one blue ball and balls are drawn at random without replacement until the blue one is drawn. An appropriate sample space might be

$$\begin{aligned}\Omega &= \{(b), (r, b), (w, b), (r, r, b), (r, w, b), \\ &\quad (w, r, b), (r, r, w, b), (r, w, r, b), (w, r, r, b)\}\end{aligned}$$

where the order in which the balls are drawn is indicated by the vector notation.

---

**Example 2.3 Toss a coin until it turns up heads**

An appropriate sample space might be

$$\Omega = \{(x_1, x_2, x_3, \dots) : x_i \in \{h, t\}\}$$

where  $h$  denotes heads and  $t$  denotes tails.

---

The sample spaces are certainly not unique. For one thing we might denote heads by  $H$  or 1 rather than  $h$ . Moreover, the experiment in Example 2.3 could be represented more efficiently by a sample space

$$\Omega = \{(x_1, x_2, x_3, \dots, x_{n-1}, x_n) : x_i = t, i \in \{1, 2, 3, \dots, n-1\}, x_n = h\}.$$

Even this efficient sample space is infinite so we prefer the sample space given in Example 2.3 which will serve in future examples. Of course all experiments end in a finite time so this sample space is just a mathematical convenience.

**Example 2.4 A stochastic process**

A stochastic or random process taking values in a countable state space  $S$  has a canonical sample space  $\Omega = S \times S \times S \times \dots$ . We may, for instance, wish to describe the weekly demand for a certain product. The possible demands are elements of  $S$  and a sample point  $\omega$  is an (theoretically) infinite sequence of weekly demands. Alternatively we might wish to describe the one byte measurements between 0 and 255 of a voice signal intensity taken every 8,000 times a second every time you make a telephone call. Hence a sample point  $\omega = (x_0, x_1, x_2, \dots)$  represents measurements  $x_n \in \{0, 1, 2, \dots, 255\}$  taken every 1.25 milliseconds; thus the index represents milliseconds. Another term for such a stochastic process is a time series.

---

**Example 2.5 ATM networks - Section 1.2 continued**

An ATM network was discussed in Chapter 1. Let's focus on the mathematical problems associated with the performance analysis of one switch in such a network. In particular let's concentrate on the buffer for the output port to Kingston in the Toronto switch. Suppose every unit of time (5 nanoseconds perhaps) an ATM multiplexor may receive, with probability  $p = 1/10$ , a cell from any of  $n = 5$  trunk lines. Every unit of time, one cell is transmitted, so if more than one cell arrives simultaneously, it joins a first-in, first-out queue. The number of cells waiting in the queue at time  $[t]$  is denoted by  $Q_{[t]}$ , where we write  $[t]$  to emphasize that  $t$  is measured in multiples of the unit time. The number of cells arriving at time unit  $[t]$  is denoted by  $A_{[t]}$  and the departure process at time  $[t]$  is denoted by  $D_{[t]}$  ( $D_{[t]}$  is either 0 or 1).

The description of the appropriate sample space for this model begins with a description of the arrival process. Let  $S = \{0, 1, 2, 3, 4, 5\}$  denote the possible number of arrivals at each time unit. Let  $N_0 = \{0, 1, 2, \dots\}$  denote the possible

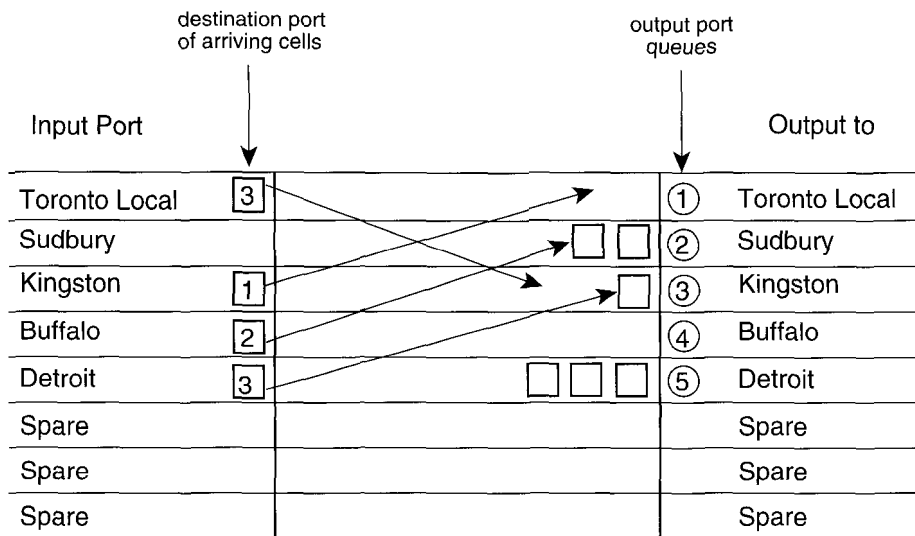

Fig. 2.1 An 8 × 8 switch

number of cells in the queue at the start of period 0. Let  $\Omega = N_0 \times S \times S \times S \times \dots$ . A sample point  $\omega \in \Omega$  will describe a starting queue size along with a sequence of possible arrivals.

A number of engineering problems arise in designing such a switch. Every microsecond a cell spends in the queue results in delayed reception at the receiving end. This is not a big problem for data cells but it is for voice cells. Since multiplexors will be cascaded at a switching node and since a call will pass through many nodes between its point of emission and point of reception these microsecond delays start to add up. Since the delay for a given cell is proportional to the number of cells queued in the buffer when that cell joins the queue, one needs a description of the queue size; the mean queue size is certainly one parameter of interest.

Another problem is buffer overloading. Excess voice cells may be discarded without much loss of clarity but all the cells in a data stream must arrive intact and in sequential order. If, by pure chance, each input stream is at peak capacity the buffer in the multiplexor will start to fill up. In the example above, all 5 lines may simultaneously present a cell to the multiplexor with probability  $1/10^5$ . One cell is transmitted so the buffer must store the other four. If this continues for 10 time slots in a row then at the end of that period there would be 40 cells in the buffer perhaps exceeding the buffer capacity. True, the chance of this is  $1/10^{50}$  but it could happen; it is a necessary evil associated with statistical multiplexing.

The next step in the construction of the probabilistic model is the identification of events or collections of outcomes of interest with subsets of  $\Omega$ . Suppose the experimenter can verify whether or not the outcome of an experiment falls in any one of a collection of subsets or events of  $\Omega$ . At the grossest level the collection of events might be  $\{\emptyset, \Omega\}$ ; in which case the experimenter gets no information upon performing the experiment. At the finest level the collection of events might be  $\mathcal{P}(\Omega)$ , the set of all subsets of  $\Omega$ . In this case the experimenter obtains perfect information – we can determine if the exact outcome  $\omega$  satisfies any arbitrary condition! To represent the partial information that might be available to an experimenter we define  $\sigma$ -algebras.

**Definition 2.6 ( $\sigma$ -Algebras)** *A collection  $\mathcal{F}$  of events or subsets of  $\Omega$  is called a  $\sigma$ -algebra if*

- $\emptyset, \Omega \in \mathcal{F}$ .
- If  $A \in \mathcal{F}$  then  $A^c \in \mathcal{F}$ .
- $\cup_{n=1}^{\infty} A_n \in \mathcal{F}$  if  $A_n \in \mathcal{F}$  for  $n = 1, 2, 3, \dots$ .

**Example 2.7 Toss a coin then a die - (2.1) continued**

Take  $\mathcal{F} = \mathcal{P}(\Omega)$  in Example 2.1 so  $\mathcal{F}$  describes the knowledge of the exact outcome of the experiment. If, for instance, an experimenter only knows about the result of the coin flip this partial knowledge is described by the  $\sigma$ -algebra  $\mathcal{H}$  which is given explicitly by

$$\{\emptyset, \Omega, \{h\} \times \{1, 2, 3, 4, 5, 6\}, \{t\} \times \{1, 2, 3, 4, 5, 6\}\}.$$

On the other hand, if the experimenter only knows about the result of the toss of the die, this partial knowledge is given by the  $\sigma$ -algebra  $\mathcal{G}$  which is given explicitly by

$$\{\emptyset, \Omega, \{t, h\} \times \mathcal{P}(\{1, 2, 3, 4, 5, 6\})\}.$$

For instance,  $\mathcal{G}$  contains the event  $\{t, h\} \times \{2, 4, 6\}$  which describes when the die turns up even.

---

**Example 2.8 Draw balls from an urn - (2.2) continued**

For Example 2.2 take  $\mathcal{F} = \mathcal{P}(\Omega)$ .

---

**Example 2.9 Toss a coin until it turns up heads - (2.3) continued**

The  $\sigma$ -algebra  $\mathcal{P}(\Omega)$  in Example 2.3 turns out to be mathematically intractable since there are simply too many subsets! Instead we define  $\mathcal{F}_n$  which represents the partial knowledge of the first  $n$  coin flips. Explicitly an atomic event  $A$  in  $\mathcal{F}_n$  may be represented as follows:

$$A = \{\{(x_1, x_2, x_3, \dots, x_n)\} \times \{h, t\} \times \{h, t\} \times \dots\}$$



where  $(x_1, x_2, x_3, \dots, x_n)$  is some specific sequence of elements from  $\{h, t\}$ . Other events in  $\mathcal{F}_n$  are constructed by taking all possible unions of atomic events. It is easy to see  $\mathcal{F}_n$  is indeed a  $\sigma$ -algebra for each  $n$ . We define  $\mathcal{F}$  to be the smallest  $\sigma$ -algebra which contains all the  $\mathcal{F}_n$ . This  $\sigma$ -algebra is much smaller than  $\mathcal{P}(\Omega)$  but contains all events of practical interest.

---

**Example 2.10 A stochastic process - (2.4) continued**

For a general product space define  $\mathcal{F}_n$  to be the set of all unions of atomic events of the form

$$A = \{ \{ (x_1, x_2, x_3, \dots, x_n) \} \times S \times S \times \dots \}$$

where  $(x_1, x_2, x_3, \dots, x_n)$  is some specific sequence in  $S^n$ . As above we define  $\mathcal{F}$  to be the smallest  $\sigma$ -algebra which contains all the  $\mathcal{F}_n$ .

---

**Example 2.11 ATM networks - (2.5) continued**

The past of the arrival process  $A_{[t]}$  up to time  $[t]$  is, as above, described by the smallest  $\sigma$ -algebra containing all atomic events of the form

$$A = \{ \{ (n, x_1, x_2, x_3, \dots, x_{[t]}) \} \times S \times S \times \dots \}.$$

Here the  $n$  is the initial number of cells in the queue and the  $x_i$ 's are the numbers of arrivals per time period.

---

The next ingredient of our probabilistic model is the probability measure  $P$ .  $P(A)$  models the probability or likelihood that an outcome  $\omega$ , in the event  $A$ , occurs when the experiment is performed. For intuitive reasons we demand that the probability of a disjoint union of events be the sum of the probabilities. The mathematical definition was given by Kolmogorov as follows:

**Definition 2.12** A probability measure  $P$  on a  $\sigma$ -algebra  $\mathcal{F}$  is a real valued function such that

- (a)  $0 \leq P(A) \leq 1$  for all  $A \in \mathcal{F}$ .
- (b)  $P(\Omega) = 1$ .
- (c) If  $\{A_1, A_2, A_3, \dots\}$  are disjoint sets all in  $\mathcal{F}$  then

$$P(\cup_{n=1}^{\infty} A_n) = \sum_{n=1}^{\infty} P(A_n).$$

Condition (b) expresses the fact that something must occur when the experiment is done. In fact, when the probability of an event is one we say that the event occurs almost surely or for almost all  $\omega$ .

Condition (c) is called  $\sigma$ -additivity and is an extrapolation of a property that holds in the following equiprobable models. In an equiprobable model each sample

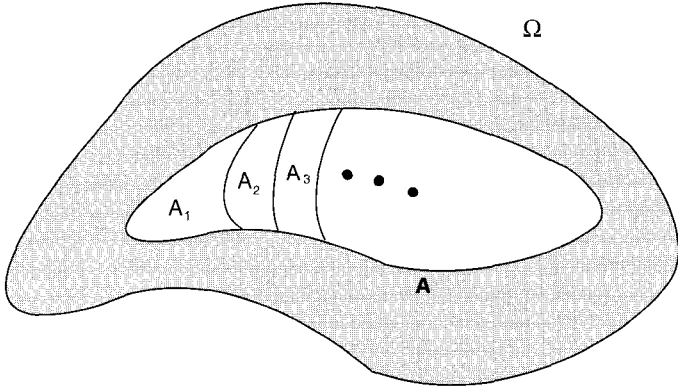

Fig. 2.2  $A$  is a disjoint union of  $A_1, A_2, \dots$

point, for reasons of symmetry, has the same probability. The following is a typical equiprobable model.

**Example 2.13 Toss a coin then a die - (2.7) continued**

In Examples 2.1 and 2.7 we might hope both the die and the coin were fair. Hence the only difference between the sample points is the label and consequently the sample points should be equiprobable. Since the union of the twelve sample points gives all of  $\Omega$  it follows that each sample point has probability  $1/12$ . Hence if  $\#(A)$  denotes the number of elements in  $A$  then  $P(A) = \sum_{\omega_i \in A} P(\{\omega_i\}) = \#(A)/12$  defines a probability measure on  $\mathcal{F} := \mathcal{P}(\Omega)$ .

---

**Definition 2.14**  $\{\Omega, \mathcal{F}, P\}$  is an equiprobable model if  $\Omega$  is finite and for all  $A \in \mathcal{F}$ ,  $P(A) = \#(A)/\#(\Omega)$  where  $\#(A)$  is the number of elements in  $A$ .

**Proposition 2.15** *Equiprobable models satisfy the conditions of Definition 2.12.*

**Proof:** Conditions a) and b) are obvious from the definition. Let  $\{A_1, A_2, A_3, \dots\}$  be disjoint sets. Since  $\Omega$  is a finite set, it follows that all but a finite number of these sets are empty. By reordering we may assume  $\{A_1, A_2, A_3, \dots, A_k\}$  are nonempty.

Therefore  $\cup_{n=1}^{\infty} A_n = \cup_{n=1}^k A_n$  so

$$\begin{aligned} P(\cup_{n=1}^{\infty} A_n) &= P(\cup_{n=1}^k A_n) = \frac{\#(\cup_{n=1}^k A_n)}{\#(\Omega)} = \sum_{n=1}^k \frac{\#(A_n)}{\#(\Omega)} \\ &= \sum_{n=1}^k P(A_n) = \sum_{n=1}^{\infty} P(A_n) \end{aligned}$$

since the probability of the empty set is 0 (see Exercise 2.9). ■

The probability measure we construct for our model depends on the nature of the experiment but if one can embed the sample space in an equiprobability model it is easy to calculate probabilities.

**Example 2.16 Draw balls from an urn - (2.8) continued**

We may embed the sample space in the space

$$\Omega' = \{(x_1, x_2, x_3, x_4) : x_i \in \{r_1, r_2, w, b\}; x_i \neq x_j, i \neq j\}$$

where  $r_1$  and  $r_2$  are imaginary labels which distinguish the two red balls. By symmetry it follows that each sample point in  $\Omega'$  has equal probability so we define the equiprobability measure  $P'$  on  $\mathcal{F}' = \mathcal{P}(\Omega')$ . To calculate the probability of sample points in  $\Omega$  we just add up the associated probabilities of corresponding points in  $\Omega'$ . For instance,  $P(\{(r, b)\})$  is given by

$$P'(\{(r_1, b, r_2, w), (r_1, b, w, r_2), (r_2, b, r_1, w), (r_2, b, w, r_1)\}) = \frac{4}{24}$$

so  $P$  is given, in tabular form, by:

$$\begin{array}{l} \omega : \quad b \quad rb \quad wb \quad rrb \quad rwb \quad wrb \quad rrw \quad rwr \quad wrr \quad b \\ P(\{\omega\}) : \frac{6}{24} \quad \frac{4}{24} \quad \frac{2}{24} \quad \frac{2}{24} \quad \frac{2}{24} \quad \frac{2}{24} \quad \frac{2}{24} \quad \frac{2}{24} \quad \frac{2}{24} \end{array}$$

Let us assume the coin in Examples 2.3 and 2.9 is biased and in the long run it seems a proportion  $p$  of the tosses turn up heads. Let us also assume the tosses are *independent* which at this point means intuitively that the result of one toss does not affect another. We construct a probability measure which will be seen later to incorporate these features.

**Example 2.17 Toss a coin until it turns up heads - (2.9) continued**

Define  $P(A)$  for atomic events  $A \in \mathcal{F}_n$  as follows:

$$P(A) = p^x(1 - p)^{n-x}$$

where  $p$  is the probability a coin turns up heads and  $x$  is the number of heads in the sequence of  $x_i$ 's. The probability of general events in  $\mathcal{F}_n$  is then forced by condition (c) in Definition 2.12; that is, we just add together the probabilities of the atomic

events whose disjoint union is the general event.

---

**Example 2.18 An independent sequence of random variables**

For the atomic event defined in Example 2.10

$$P(A) = p_1(x_1) \cdot p_2(x_2) \cdots p_n(x_n)$$

where  $p_i(x_i)$  is the probability the demand in week  $i$  is  $x_i$  units. Again the probability of general events in  $\mathcal{F}_n$  is forced by condition (c) in Definition 2.12.

---

**Example 2.19 ATM networks - (2.11) continued**

We may define the probability of an atomic event as in Example 2.18; that is

$$P(A) = p_0(n) \cdot p(x_1) \cdot p(x_2) \cdots p(x_{[t]}).$$

As mentioned above, this implies the number of arrivals at time  $[t]$  is independent of the number of arrivals at any other time and also the queue size at time 0. Taking the  $p$ 's to be the same after  $p_0$  will ensure that the arrival process is homogeneous in time (as we shall see).

---

The definitions in Examples 2.17 to 2.19 are not complete of course since we have not defined  $P$  on all of  $\mathcal{F}$ . This involves the Kolmogorov extension theorem which is discussed in Section 2.8.

The following properties of probability measures are left as exercises.

**Proposition 2.20** *Let  $P$  be a probability measure on a  $\sigma$ -algebra  $\mathcal{F}$ . Then*

- (a)  $P(A^c) = 1 - P(A)$  for all  $A \in \mathcal{F}$ .
- (b)  $P(A \cup B) = P(A) + P(B) - P(B \cap A)$ .
- (c) If  $A \subset B$  with  $A$  and  $B$  in  $\mathcal{F}$  then  $P(A) \leq P(B)$ .
- (d) If  $\{A_1, A_2, A_3, \dots\}$  are sets in  $\mathcal{F}$  then

$$P(\cup_{n=1}^{\infty} A_n) \leq \sum_{n=1}^{\infty} P(A_n).$$

## 2.2 Random Variables

The last major ingredient in our probability model is that of a random variable. Random variables,  $X, Y$  say, measure different aspects of each sample point.

**Definition 2.21** A random variable  $X$  is a function defined on  $\Omega$  taking values in the real line such that  $\{X \leq x\} := \{\omega : X(\omega) \leq x\} \in \mathcal{F}$  for all real  $x$ . Notation like  $\{X \leq x\}$  (or  $\{X = x\}$ ) is often used and should always be interpreted as a set of

$\omega$ . Let  $\mathcal{F}^X$  denote the smallest  $\sigma$ -algebra inside  $\mathcal{F}$  containing events like  $\{X \leq x\}$  or  $\{X = x\}$ .

We shall mainly restrict ourselves to discrete random variables; that is random variables taking on at most a denumerable number of values in a range denoted by  $\mathcal{R}_X$ . For discrete random variables

$$\{\omega : X(\omega) \leq x\} = \cup_{y \leq x} \{\omega : X(\omega) = y; y \in \mathcal{R}_X\}$$

so for  $X$  to be a random variable it suffices that  $\{\omega : X(\omega) = x\} \in \mathcal{F}$  for any real  $x$ .  $\mathcal{F}^X$  is called the family of events generated by  $X$ .

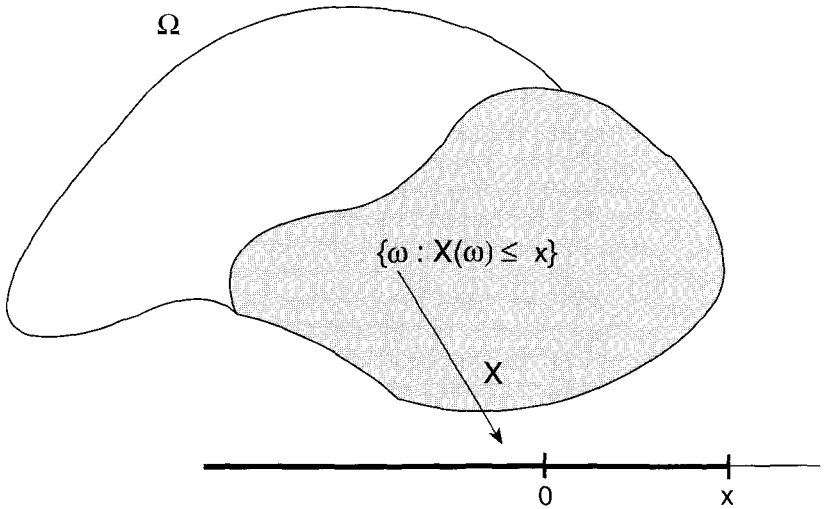

Fig. 2.3 A random variable.

**Example 2.22 Toss a coin then a die - (2.13) continued**

Define  $X$  to be 1 if the coin turns up heads and 0 otherwise. Define  $Y$  to be the value that turns up on the die. Clearly the range of values of both  $X$  and  $Y$  is finite and both are random variables.

**Example 2.23 Draw balls from an urn - (2.16) continued**

Let  $X$  denote the number of red balls drawn and let  $Y$  be the number of white balls drawn.

**Example 2.24 Toss a coin until it turns up heads - (2.17) continued**

Define  $T$  to be the number of coin tosses until a head turns up. Clearly  $T$  takes

on a denumerable number of values -  $\mathcal{R}_T = \{1, 2, 3, \dots\}$ . Moreover, for  $n \in \mathcal{R}_T$  we have

$$\{\omega : T(\omega) = n\} = \{(t, t, t, \dots, t, h) \times \{h, t\} \times \{h, t\} \times \dots\}$$

where there are  $n - 1$   $t$ 's before the first  $h$ . This event is in  $\mathcal{F}_n$  by definition and hence is also in  $\mathcal{F}$ . It follows that  $T$  is a random variable.

**Example 2.25 A stochastic process - (2.10) continued**

For any sample point  $\omega = (x_1, x_2, \dots, x_i, \dots)$  define  $X_i(\omega) = x_i$ . Clearly any atomic event in  $\mathcal{F}_n$  is of the form  $\{\omega : X_1(\omega) = x_1, \dots, X_n(\omega) = x_n\}$ .

**Example 2.26 ATM networks - (2.19) continued**

The stochastic process  $Q_0, A_1, A_2, \dots$  is now seen as a sequence of random variables defined on the sample space  $\Omega$  as in Example 2.25. In particular, if  $\omega = (n, x_1, x_2, \dots)$  then  $Q_0(\omega) = n$  and  $A_1(\omega) = x_1$ . As mentioned above, this implies the number of arrivals at time  $[t]$  is independent of the number of arrivals at any other time and also of the number of cells in the queue at time 0.

We may, moreover, define the queue  $Q_{[t]}$  on  $\Omega$  recursively as

$$Q_{[t+1]}(\omega) = \max\{Q_{[t]}(\omega) + A_{[t+1]}(\omega) - 1, 0\}.$$

The queue size at time  $[t + 1]$  is equal to the queue size at time  $[t]$  plus the number of arrivals during period  $[t + 1]$  minus 1 since one cell is transmitted per period. Of course the queue can only be reduced to 0, hence the maximum with 0. Similarly we may define the departure process  $D_{[t+1]} = \chi\{Q_{[t]} + A_{[t+1]} > 0\}$ ; that is  $D_{[t+1]}$  is 1 if the queue at time  $[t]$  plus the new arrivals during the time period  $[t]$  to  $[t + 1]$  is not 0, otherwise  $D_{[t+1]} = 0$ .

It is interesting to consider the  $\sigma$ -algebra  $\mathcal{F}_t^D$  generated by atomic events associated with departures up to time  $[t]$ :

$$\{\omega : D_1(\omega) = d_1, D_2(\omega) = d_2, \dots, D_{[t]}(\omega) = d_{[t]}\} \text{ where } d_s \in \{0, 1\}, s = 1, 2, \dots$$

This is the past of the departure process and is the information which is available to the next node in the network receiving cells from the ATM multiplexor. It is a sub- $\sigma$ -algebra since it does not give the queueing process and, as we shall see, the past of the departure process  $\mathcal{F}_t^D$  is often independent of the queue size  $Q_{[t]}$  at time  $[t]$ .

**Definition 2.27** Formally a stochastic process is a collection of random variables  $\{X_t\}$ , defined on a probability space indexed by a parameter  $t$  (often representing time). For each sample point  $\omega$ , the coordinate functions  $\{X_1(\omega), X_2(\omega), \dots\}$  specify the trajectory of the stochastic process. The past of the process until index  $t$  is the  $\sigma$ -algebra  $\mathcal{F}_t^X$  generated by the atomic events  $\{\omega : X_1(\omega) = x_1, \dots, X_t(\omega) = x_n\}$ . One can write  $\mathcal{F}_t^X = \sigma\{X_0, X_1, \dots, X_t\}$ .

**Definition 2.28** Given an increasing sequence of  $\sigma$ -algebras  $\mathcal{F}_t$  inside a probability space  $\{\Omega, \mathcal{F}\}$ , define a stopping time  $T$  to be a random variable such that  $\{T \leq t\} \in \mathcal{F}_t$  for all  $t$ .

A stopping time models the realistic situation where a decision to continue or not at time  $t$  is based on the information available up to time  $t$ ; that is  $\mathcal{F}_t$ . Suppose we model the result of a sequence of coin tosses as a stochastic process. All we need to do is replace h by 1 and t by 0 in Example 2.24. Hence the coordinate functions in Example 2.25 above associate a head with the value 1 and a tail with 0. Clearly the number of tosses of a coin required to get the first head considered in Example 2.24 is a stopping time for the sequence of  $\sigma$ -algebras defined by the coordinate functions.

**Example 2.29 ATM networks - (2.26) continued**

Let  $\tau$  denote the first time a cell is lost because  $Q_{[\tau-1]} + A_\tau - 1 > B$  where  $B$  is the buffer space available.  $\tau$  is a stopping time.

In order to summarize the description of a random variable we define the associated probability distribution function.

**Definition 2.30** The probability mass function or p.m.f. associated with the random variable  $X$  is  $p_X(x) = P(\{\omega : X(\omega) = x\})$  for any  $x \in \mathcal{R}_X$ . The distribution function associated with  $X$  is a function of a real variable ( $t$  in this case) given by  $F_X(t) = P(\{\omega : X(\omega) \leq t\})$ .

Henceforth, we shall not write  $\omega$  explicitly so we might write simply  $p_X(x) = P(X = x)$  or  $F_X(t) = P(X \leq t)$ . We note that both these expressions make sense when  $X$  is a random variable since by definition  $\{\omega : X(\omega) \leq t\} \in \mathcal{F}$  (that  $\{\omega : X(\omega) = x\} \in \mathcal{F}$  if  $X$  is a random variable is left as an exercise).

**Example 2.31 Toss a coin then a die - (2.22) continued**

$$p_X(1) = P(\{\omega : X(\omega) = 1\}) = P(\{(h, 1), (h, 2), \dots, (h, 6)\}) = 1/2.$$

Similarly  $p_X(0) = 1/2$ . In tabular form this may be written

$$\begin{array}{l} x : 0 \quad 1 \\ p_X(x) : \frac{1}{2} \quad \frac{1}{2}. \end{array}$$

Similarly

$$\begin{array}{l} y : 1 \quad 2 \quad 3 \quad 4 \quad 5 \quad 6 \\ p_Y(y) : \frac{1}{6} \quad \frac{1}{6} \quad \frac{1}{6} \quad \frac{1}{6} \quad \frac{1}{6} \quad \frac{1}{6}. \end{array}$$

**Example 2.32 Draw balls from an urn - (2.23) continued**

$$\begin{aligned}
 p_X(0) &= P(\{\omega : X(\omega) = 0\}) = P(\{(b), (w, b)\}) = 1/3 \\
 p_X(1) &= P(\{\omega : X(\omega) = 1\}) = P(\{(r, b), (r, w, b), (r, w, b)\}) \\
 &= 1/3.
 \end{aligned}$$

$$\begin{aligned}
 p_X(2) &= P(\{\omega : X(\omega) = 2\}) \\
 &= P(\{(r, r, b), (r, r, w, b), (r, w, r, b), (w, r, r, b)\}) = 1/3.
 \end{aligned}$$

In tabular form this may be written

$$\begin{aligned}
 x &: 0 \quad 1 \quad 2 \\
 p_X(x) &: \frac{1}{3} \quad \frac{1}{3} \quad \frac{1}{3}.
 \end{aligned}$$

Similarly

$$\begin{aligned}
 y &: 0 \quad 1 \\
 p_Y(y) &: \frac{1}{2} \quad \frac{1}{2}.
 \end{aligned}$$

**Example 2.33 Toss a coin until it turns up heads - (2.24) continued**

For  $x \in \mathcal{R}_T$

$$\begin{aligned}
 p_T(x) &= P(\{(t, t, t, \dots, t, h) \times \{h, t\} \times \{h, t\} \times \dots\}) \\
 &= (1 - p)^{x-1} p
 \end{aligned}$$

by Example 2.24. This is the probability mass function of a geometric random variable.

In order to describe the bivariate or multivariate nature of random variables, we define the joint probability mass function (joint p.m.f.):

**Definition 2.34 (The joint probability mass function)** For random variables  $X$  and  $Y$  define

$$p_{X,Y}(x, y) = P(\{\omega : X(\omega) = x, Y(\omega) = y\})$$

where  $x \in \mathcal{R}_X$ ,  $y \in \mathcal{R}_Y$ . In general, for vector valued random variables  $\vec{X} = (X_1, \dots, X_n)$ , define the joint probability mass function by

$$p_{\vec{X}}(x_1, \dots, x_n) = P(\{\omega : X_1(\omega) = x_1, \dots, X_n(\omega) = x_n\}).$$



**Definition 2.35 (The joint distribution function)** For random variables  $X$ ,  $Y$  and random vector  $\vec{X}$ , define

$$F_{X,Y}(x, y) = P(X \leq x, Y \leq y)$$

and

$$F_{\vec{X}}(x_1, \dots, x_n) = P(X_1 \leq x_1, \dots, X_n \leq x_n)$$

for all choices of real numbers  $x, y, x_1, \dots, x_n$

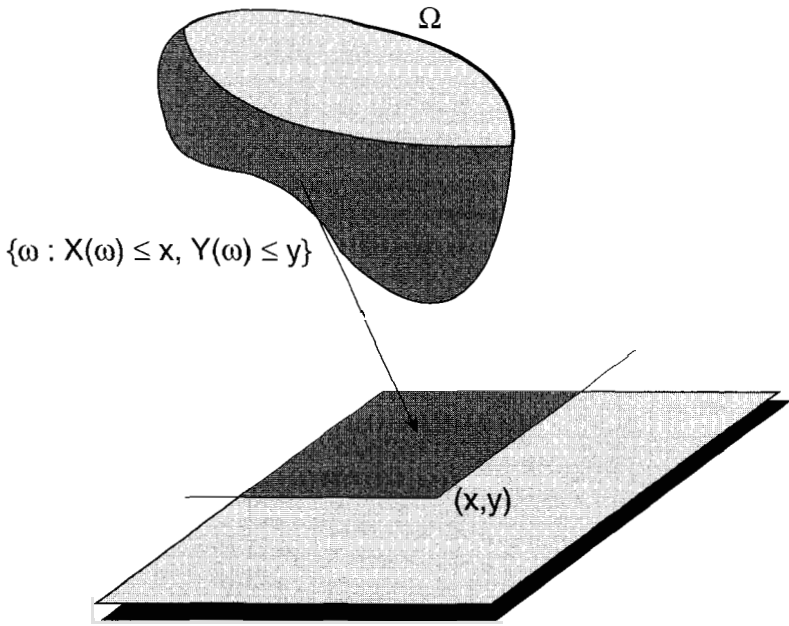

Fig. 2.4 Jointly distributed random variables.

The properties of  $F_{X,Y}$  and  $F_{\vec{X}}$  are similar to those of  $F_X$ . An immediate observation is that we can get the *marginal* p.m.f. from the joint p.m.f. as follows:

**Theorem 2.36**

$$\sum_{x \in \mathcal{R}_X} p_{X,Y}(x, y) = p_Y(y)$$

and similarly,

$$\sum_{y \in \mathcal{R}_Y} p_{X,Y}(x, y) = p_X(x).$$

More generally,

$$\sum_{x_k \in \mathcal{R}_{X_k}} p_{\widehat{X}}(x_1, \dots, x_k, \dots, x_n) = p_{X_1, \dots, \widehat{X}_k, \dots, X_n}(x_1, \dots, \widehat{x}_k, \dots, x_n),$$

where  $\widehat{\phantom{x}}$  over a variable means this variable is omitted from the sequence.

**Proof:** We just prove the first statement. Note

$$\{\omega : Y(\omega) = y\} = \dot{\cup}_{x \in \mathcal{R}_X} \{X(\omega) = x, Y(\omega) = y\}$$

where  $\dot{\cup}$  denotes the disjoint union. Hence, by Definition 2.12,

$$\begin{aligned} p_Y(y) &= P(Y = y) = \sum_{x \in \mathcal{R}_X} P(\{\omega : X(\omega) = x, Y(\omega) = y\}) \\ &= \sum_{x \in \mathcal{R}_X} p_{X,Y}(x, y). \end{aligned}$$

■

### Example 2.37 An independent sequence - (2.18) continued

By Theorem 2.36 the p.m.f. of coordinate  $X_i$  is

$$\begin{aligned} p_{X_i}(x_i) &= \sum_{j \neq i} \sum_{x_j \in \mathcal{R}_{X_j}} p_{\widehat{X}}(x_1, \dots, x_n) \\ &= \sum_{j \neq i} \sum_{x_j \in \mathcal{R}_{X_j}} p_1(x_1) \cdots p_i(x_i) \cdots p_n(x_n) \\ &= p_i(x_i) \end{aligned}$$

where we used the fact that

$$\sum_{x_j \in \mathcal{R}_{X_j}} p_j(x_j) = 1.$$

We see the marginal distributions of the coordinate functions in this construction of a stochastic process have specified p.m.f.'s given by  $p_i$ . Later we shall see that the  $X_i$ 's are independent for the product probability  $P$  specified here.

## 2.3 Expectation

We work up to a general definition of expectation by starting with simple random variables.

**Definition 2.38** A random variable  $X$  defined on a probability space  $\{\Omega, \mathcal{F}, P\}$  is called simple if it takes on only a finite number of values; i.e.  $\mathcal{R}_X$  is finite.

**Definition 2.39** The expected value of a simple random variable  $X$  is

$$EX = \sum_{x \in \mathcal{R}_X} xP(X = x) = \sum_{x \in \mathcal{R}_X} xp_X(x).$$

This definition will be extended to general random variables but at this point let us just state that for discrete random variables this extension yields the same expression as above; that is

$$EX = \sum_{x \in \mathcal{R}_X} xp_X(x) \text{ provided } E|X| = \sum_{x \in \mathcal{R}_X} |x|p_X(x) < \infty.$$

Random variables such that  $E|X| < \infty$  are called integrable.

The expected value measures the location of the center of mass of the distribution and has the following monotonicity and linearity properties:

**Theorem 2.40 (Monotonicity)** *If  $X \leq Y$ , that is  $X(\omega) \leq Y(\omega)$  for all  $\omega$  then  $EX \leq EY$ .*

**Proof:** We only give the proof for simple random variables.

$$P(X = x) = \sum_{y \in \mathcal{R}_Y} P(X = x, Y = y).$$

Note that if  $x > y$  then  $P(X = x, Y = y) = 0$  so by the definition of expectation

$$\begin{aligned} EX &= \sum_{x \in \mathcal{R}_X} xP(X = x). \\ &= \sum_{x \in \mathcal{R}_X} \sum_{y \in \mathcal{R}_Y} xp(X = x, Y = y) \\ &\leq \sum_{x \in \mathcal{R}_X} \sum_{y \in \mathcal{R}_Y} yp(X = x, Y = y) \\ &= EY. \end{aligned}$$

■

**Theorem 2.41 (Linearity)** *If  $\alpha$  and  $\beta$  are constants then*

$$E(\alpha X + \beta Y) = \alpha EX + \beta EY.$$

**Proof:** Again we only give the proof for simple random variables. The random variable  $\alpha X + \beta Y$  takes the value  $z = \alpha x + \beta y$  on the set  $\{\omega : X(\omega) = x, Y(\omega) = y\}$ . Let  $\chi_{\{\alpha x + \beta y = z\}}$  be the indicator function which takes the value 1 if the equality

$\alpha x + \beta y = z$  is satisfied and 0 otherwise. By definition then

$$\begin{aligned}
 E(\alpha X + \beta Y) &= \sum_z z P(\alpha X + \beta Y = z) \\
 &= \sum_z z \sum_{x,y} \chi\{\alpha x + \beta y = z\} P(\{\omega : X(\omega) = x, Y(\omega) = y\}) \\
 &= \sum_{x,y} (\alpha x + \beta y) p_{X,Y}(x, y) \\
 &= \alpha \sum_{x,y} x p_{X,Y}(x, y) + \beta \sum_{x,y} y p_{X,Y}(x, y) \\
 &= \alpha \sum_x x p_X(x) + \beta \sum_y y p_Y(y) \\
 &= \alpha EX + \beta EY
 \end{aligned}$$

where we used Theorem 2.36. ■

Taking an abstract point of view we see that any probability  $P$  on  $\{\Omega, \mathcal{F}\}$  is associated with an expectation  $E(\cdot)$  which acts as a linear operator on the (vector) space of random variables.

The following law of the unconscious statistician will prove very useful.

**Theorem 2.42** *Let  $h_1, h_2$  and  $h_n$  be real valued functions of 1, 2 and  $n$  variables respectively, so  $h_1(X), h_2(X, Y)$  and  $h_n(\vec{X})$  are discrete random variables and*

$$Eh_1(X) = \sum_{x \in \mathcal{R}_X} h_1(x) p_X(x)$$

$$Eh_2(X, Y) = \sum_{x \in \mathcal{R}_X; y \in \mathcal{R}_Y} h_2(x, y) p_{X,Y}(x, y)$$

$$Eh_n(\vec{X}) = \sum_{x_1 \in \mathcal{R}_{X_1}} \dots \sum_{x_n \in \mathcal{R}_{X_n}} h_n(x_1, \dots, x_n) p_{\vec{X}}(x_1, \dots, x_n).$$

**Proof:** Again we only show this result for simple random variables and we will only establish the first expression since the others follow in the same way. Let  $Z = h_1(X)$ . By definition

$$\begin{aligned}
 Eh_1(X) &= \sum_{z \in \mathcal{R}_Z} z P(Z = z) = \sum_{z \in \mathcal{R}_Z} \sum_{x \in \mathcal{R}_X; h_1(x)=z} h_1(x) P(X = x) \\
 &= \sum_{x \in \mathcal{R}_X} h_1(x) P(X = x) \\
 &= \sum_{x \in \mathcal{R}_X} h_1(x) p_X(x).
 \end{aligned}$$
■

The law of the unconscious statistician allows us to calculate the expected value of functions of a discrete random variable.

**Definition 2.43** The mean of a random variable  $X$  is  $\mu_X \equiv EX = \sum xp_X(x)$  and the variance is

$$\sigma_X^2 \equiv E(X - EX)^2 = \sum (x - \mu_X)^2 p_X(x).$$

The standard deviation is  $\sigma_X$ .

**Theorem 2.44** If  $X$  is a positive random variable with finite mean  $\mu_X$  then

$$P(X \geq \ell) \leq \frac{\mu_X}{\ell} \quad (\text{Markov's Inequality}).$$

If  $X$  has a finite mean and variance then

$$P(|X - \mu_X| \geq \ell) \leq \frac{\sigma_X^2}{\ell^2} \quad (\text{Chebyshev's Inequality}).$$

**Proof:** Markov's Inequality is immediate since

$$EX \geq \sum_{x \geq \ell} xp_X(x) \geq \ell \cdot P(X \geq \ell).$$

The result follows by dividing both sides by  $\ell$ . Chebyshev's inequality follows analogously. ■

**Example 2.45** Draw balls from an urn - (2.32) continued

In this example

$$EX = 0 \cdot p_X(0) + 1 \cdot p_X(1) + 2 \cdot p_X(2) = 1 \cdot \frac{1}{3} + 2 \cdot \frac{1}{3} = 1.$$

Similarly  $EY = 0 \cdot p_Y(0) + 1 \cdot p_Y(1) = 1 \cdot \frac{1}{2} = \frac{1}{2}$ . The joint p.m.f.  $p_{X,Y}(x, y)$  for  $X$  and  $Y$  is given by

$$\begin{array}{r} : y = 0 \quad y = 1 \\ x = 0 : 3/12 \quad 1/12 \\ x = 1 : 2/12 \quad 2/12 \\ x = 2 : 1/12 \quad 3/12 \end{array}$$

On the other hand the law of the unconscious statistician applied to the function  $H_2(x, y) = x + y$  allows us to evaluate  $E(X + Y)$  as

$$\begin{aligned} & (0+0)\frac{3}{12} + (1+0)\frac{2}{12} + (2+0)\frac{1}{12} + (0+1)\frac{1}{12} + (1+1)\frac{2}{12} + (2+1)\frac{3}{12} \\ & \equiv \frac{18}{12}. \end{aligned}$$

It is interesting to verify that  $E(X + Y) = EX + EY$ .

## 2.4 Conditional Probabilities

Consider an equiprobable measure  $P$  on a finite probability space  $\{\Omega, \mathcal{F}\}$  where  $\mathcal{F} = \mathcal{P}(\Omega)$ . The probability of an event  $A$  is therefore given by

$$\frac{\#(A)}{\#(\Omega)}$$

where  $\#(A)$  denotes the number of elements in  $A$ . If the experimenter knows  $A$  has occurred and wishes to know the probability another event  $B$  has also occurred, it follows from symmetry that each of the sample points in  $A$  is equally likely with probability  $1/\#(A)$  so that the conditional probability of  $B$  occurring is

$$P(B|A) \equiv \frac{\#(A \cap B)}{\#(A)}.$$

$$P(B|A) = \frac{\#(A \cap B)}{\#(A)}$$

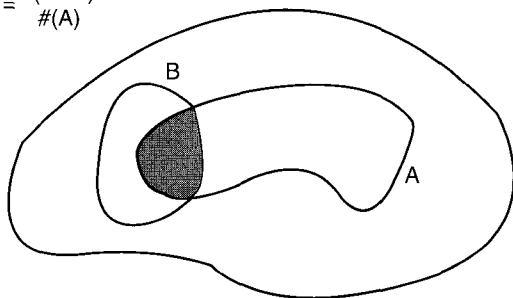

Fig. 2.5 Conditional probabilities.

This definition is extended to general probability spaces:

### Definition 2.46

$$P(B|A) = \frac{P(A \cap B)}{P(A)}$$

defines the conditional probability of an event  $B$  occurring, given the event  $A$  has occurred.  $P(\cdot|A)$  defines a probability measure on  $\{\Omega, \mathcal{F}\}$ . Since  $P(\cdot|A)$  does satisfy all the conditions of Definition 2.12 it follows that we may define the associated expectation denoted  $E(\cdot|A)$ . To be precise, if  $X$  is a random variable then

$$E(X|A) = \sum_{x \in \mathcal{R}_X} xP(X = x|A) = \sum_{x \in \mathcal{R}_X} x \frac{P(\{X = x\} \cap A)}{P(A)}.$$

**Proposition 2.47** *If  $X$  is a random variable and  $A$  an event then  $E(X|A) = E(X \cdot \chi_A)/P(A)$  where  $\chi_A$  denotes the indicator function of the set  $A$ ; that is  $\chi_A(\omega) = 1$  if  $\omega \in A$  and is 0 otherwise.*

**Proof:** First assume  $X$  is simple and nonnegative

$$\begin{aligned} E(X|A) &= \sum_{x \in \mathcal{R}_X} xP(X = x|A) \\ &= \sum_{x \in \mathcal{R}_X} xP(\{\omega : X(\omega) = x, \omega \in A\})/P(A) \\ &= E(X \cdot \chi_A)/P(A) \end{aligned}$$

since  $X \cdot \chi_A(\omega) = \sum_{x \in \mathcal{R}_X} x \cdot \chi_{\{X(\omega)=x, \omega \in A\}}$ ; that is  $X \cdot \chi_A$  takes the value  $x$  on  $\{X(\omega) = x, \omega \in A\}$ . Now extend the result by taking monotone limits of simple functions. The signed case follows by linearity. ■

**Definition 2.48** Let  $\vec{X}, \vec{Y}$  be random vectors. We define the conditional probability mass function (conditional p.m.f.) of  $\vec{Y}$  given  $\vec{X}$  by

$$p_{\vec{Y}|\vec{X}}(\vec{y}|\vec{x}) = P(\vec{Y} = \vec{y}|\vec{X} = \vec{x}) = \frac{P(\vec{X} = \vec{x}, \vec{Y} = \vec{y})}{P(\vec{X} = \vec{x})}.$$

In general,  $P(\cdot|\vec{X} = \vec{x})$  is the conditional probability given  $\vec{X} = \vec{x}$ . The definition for random variables is simply the non-vector version of this definition. The conditional distribution function of  $\vec{Y}$  given  $\vec{X}$  is defined by

$$F_{\vec{Y}|\vec{X}}(\vec{y}|\vec{x}) = P(\vec{Y} \leq \vec{y}|\vec{X} = \vec{x})$$

where  $\vec{Y} \leq \vec{y}$  means  $\vec{Y}$  is less than  $\vec{y}$ , component by component.

As in Definition 2.46,  $P(\cdot|\vec{X} = \vec{x})$  has an associated expectation denoted  $E(\cdot|\vec{X} = \vec{x})$ . For instance

$$E(Y|X = x) = \sum_{y \in \mathcal{R}_Y} yP(Y = y|X = x) = \sum_{y \in \mathcal{R}_Y} yp_{Y|X}(y|x).$$

**Theorem 2.49** *Let  $X$  be a random variable and for each  $x \in \mathcal{R}_X$  let  $H(x) := h(x, \omega)$  be a random variable (assuming a denumerable number of values). Consider the random variable  $h(X(\omega), \omega)$  such that  $E|h(X(\omega), \omega)| < \infty$ . Then*

$$Eh(X(\omega), \omega) = \sum_{x \in \mathcal{R}_X} E(h(x, \omega)|X = x)p_X(x).$$

**Proof:** Using the fact that  $\Omega = \cup_{x \in \mathcal{R}_X} \{\omega : X(\omega) = x\}$  we have by Corollary 2.68 that

$$\begin{aligned} E h(X(\omega), \omega) &= \sum_{x \in \mathcal{R}_X} E [h(X(\omega), \omega) \cdot \chi_{\{X=x\}}(\omega)] \\ &= \sum_{x \in \mathcal{R}_X} E [h(x, \omega) \cdot \chi_{\{X=x\}}(\omega)] \\ &= \sum_{x \in \mathcal{R}_X} E(h(x, \omega) | X = x) P(X = x) \text{ by Proposition 2.47.} \end{aligned}$$

■

**Corollary 2.50** *If  $f$  is a real-valued function of two real variables such that  $E|f(X, Y)| < \infty$  then*

$$E f(X, Y) = \sum_{x \in \mathcal{R}_X} E[f(x, Y) | X = x] p_X(x).$$

*Analogous formulae hold for random vectors.*

**Proof:** Let  $h(x, \omega) = f(x, Y(\omega))$  and apply Theorem 2.49. ■

**Example 2.51 Draw balls from an urn - (2.45) continued**

The conditional p.m.f. for  $X$  given  $Y$  is  $p_{X|Y}(x|y)$  given by

$$\begin{array}{ccc} x: & 0 & 1 & 2 & & x: & 0 & 1 & 2 \\ p_{X|Y}(x|0): & 1/2 & 1/3 & 1/6 & & p_{X|Y}(x|1): & 1/6 & 1/3 & 1/2 \end{array}$$

Hence

$$E(X|Y = 0) = 0 \cdot \frac{1}{2} + 1 \cdot \frac{1}{3} + 2 \cdot \frac{1}{6} = \frac{2}{3}$$

and

$$E(X|Y = 1) = 0 \cdot \frac{1}{6} + 1 \cdot \frac{1}{3} + 2 \cdot \frac{1}{2} = \frac{4}{3}.$$

It is interesting to verify that

$$E(X + Y) = E(X + 0 | Y = 0) p_Y(0) + E(X + 1 | Y = 1) p_Y(1) = 1.5.$$

---

It is useful to define the conditional probability given events defined by random variables or random vectors.

**Definition 2.52** Let  $X$  be a random variable and let  $\vec{X} = (X_1, \dots, X_n)$  be a random vector. Denote by  $P(\cdot | X) \equiv P(\cdot | \mathcal{F}^X)$  the conditional probability measure



defined as follows. For any event  $A \in \mathcal{F}$  and any sample point  $\omega$  such that  $X(\omega) = x$ , define

$$P(A|X)(\omega) = P(A|X = x) = P(A|\{X = x\}).$$

Note that  $P(A|X)(\omega)$  is constant for  $\omega \in \{X = x\}$ . Let  $E(\cdot|X) \equiv E(\cdot|\mathcal{F}^X)$  be the associated expectation. These definitions can also be extended to vectors: for any event  $A \in \mathcal{F}$  and any sample point  $\omega$  such that  $\vec{X}(\omega) = \vec{x}$ , define

$$P(A|\vec{X})(\omega) = P(A|\vec{X} = \vec{x}) = P(A|\{\vec{X} = \vec{x}\}).$$

Again, let  $E(\cdot|\vec{X}) \equiv E(\cdot|\mathcal{F}^{\vec{X}})$  be the associated expectation.

Rewriting Corollary 2.50 we have

**Corollary 2.53** *If  $f$  is a real valued function of two real variables such that  $E|f(X, Y)| < \infty$  then*

$$Ef(X, Y) = E(E[f(X, Y)|X]) = E(E[f(X, Y)|\mathcal{F}^X]).$$

*Analogous formulae hold for random vectors.*

**Example 2.54** Consider an on-line file updating system. Let  $p_i$  be the probability that a transaction is of type  $i$  where  $i \in \{1, 2, \dots, n\}$ . The size in bytes of the record of transaction type  $i$  to be inserted into a file may be represented by a random variable  $Y_i$ , which has mean  $\mu_i$  and variance  $\sigma_i^2$ . Determine the expected number of bytes per transaction and the variance of the number of bytes per transaction.

It is best to define a random variable  $T$  having probability mass function  $p_T(i) = p_i$  for  $i = 1, \dots, n$ . Hence the number of bytes in a transaction may be represented by  $Y_T$ . Now setting  $h(i, \omega) = Y_i(\omega)$  and applying Theorem 2.49 we have

$$\begin{aligned} EY_T &= Eh(T, \omega) = \sum_{i=1}^n E(Y_i|T = i) \cdot P(T = i) \\ &= \sum_{i=1}^n E(Y_i) \cdot p_i = \sum_{i=1}^n \mu_i p_i. \end{aligned}$$

The second moment follows in a similar fashion since

$$\begin{aligned} EY_T^2 &= \sum_{i=1}^n E(Y_i^2|T = i) \cdot P(T = i) \\ &= \sum_{i=1}^n E(Y_i^2) \cdot p_i = \sum_{i=1}^n (\sigma_i^2 + \mu_i^2) p_i. \end{aligned}$$

The variance calculation is immediate.

## 2.5 Independence

The assumption of independence leads to enormous simplifications in our calculations. First of all we say two events  $F$  and  $G$  are independent if  $P(F \cap G) = P(F)P(G)$ . This is equivalent to saying  $P(B|A) = P(B)$ ; i.e. knowing  $A$  has occurred tells you nothing about the probability of  $B$  occurring.

### Example 2.55 Toss a coin then a die - (2.31) continued

If  $F$  represents the event the coins is heads and  $G$  represents the event the die gives a 4 then it is easy to check  $P(F) = P(\{\{h\} \times \{1, \dots, 6\}\}) = 1/2$  and  $P(G) = P(\{\{h, t\} \times \{4\}\}) = 1/6$ . Moreover,

$$P(F \cap G) = P(\{(h, 4)\}) = 1/12 = P(F) \cdot P(G).$$

---

We now extend the notion of independence to discrete random variables.

**Definition 2.56** Two discrete random variables  $X$  and  $Y$  are independent if  $p_{X,Y}(x, y) = p_X(x) \cdot p_Y(y)$  for all  $x \in \mathcal{R}_X$  and all  $y \in \mathcal{R}_Y$ . Similarly two discrete random vectors  $\vec{X}$  and  $\vec{Y}$  are independent if

$$p_{\vec{X}, \vec{Y}}(\vec{x}, \vec{y}) = p_{\vec{X}}(\vec{x})p_{\vec{Y}}(\vec{y}).$$

We remark that this definition doesn't work for random variables that aren't discrete. The notion of independence is extended to general random variables in the Appendix.

**Proposition 2.57** *If  $X$  and  $Y$  are independent then  $E[X \cdot Y] = EX \cdot EY$ .*

**Proof:** Since  $X$  and  $Y$  are independent

$$\begin{aligned} E[X \cdot Y] &= \sum_{x \in \mathcal{R}_X} \sum_{y \in \mathcal{R}_Y} x \cdot y P_{X,Y}(x, y) \\ &= \sum_{x \in \mathcal{R}_X} x p_X(x) \sum_{y \in \mathcal{R}_Y} y p_Y(y) \\ &= EX \cdot EY. \end{aligned}$$

■

**Corollary 2.58** *If  $Y$  is independent of  $\vec{X}$  then  $E(Y|\vec{X}) = EY$ .*

**Proof:**

$$\begin{aligned}
 E(Y|\vec{X} = \vec{x}) &= \sum_{y \in \mathcal{R}_Y} y P(Y = y | \vec{X} = \vec{x}) \\
 &= \sum_{y \in \mathcal{R}_Y} y \frac{P(\vec{X} = \vec{x}, Y = y)}{P(\vec{X} = \vec{x})} = \sum_{y \in \mathcal{R}_Y} y \frac{p_{\vec{X}, Y}(\vec{x}, y)}{p_{\vec{X}}(\vec{x})} \\
 &= \sum_{y \in \mathcal{R}_Y} y p_Y(y) = EY \text{ by independence.}
 \end{aligned}$$

■

**Corollary 2.59** Suppose  $X = f(X_1, \dots, X_n)$  and the random vector  $\vec{X} = (X_1, \dots, X_n)$  is independent of the  $Y$ . Then  $X$  is independent of  $Y$ .

**Proof:**

$$\begin{aligned}
 P(X = x, Y = y) &= P(\cup_{\vec{x} \in \mathcal{R}_{\vec{X}}: f(\vec{x})=x} \{X_1 = x_1, \dots, X_n = x_n\} \cap \{Y = y\}) \\
 &= \sum_{\vec{x}: f(\vec{x})=x} p_{\vec{X}, Y}(\vec{x}, y) = \sum_{\vec{x}: f(\vec{x})=x} p_{\vec{X}}(\vec{x}) p_Y(y) \\
 &= P(X = x) \cdot p_Y(y) = p_X(x) \cdot p_Y(y)
 \end{aligned}$$

for any choices of  $x \in \mathcal{R}_X$  and all  $y \in \mathcal{R}_Y$ . It follows that  $X$  and  $Y$  are independent.

■

**Corollary 2.60** If  $X$  and  $Y$  are independent random variables then the variance of  $X + Y$  which we denote by  $\text{Var}(X + Y)$  is the sum of the variances,  $\text{Var}(X)$  and  $\text{Var}(Y)$ , of  $X$  and  $Y$  respectively.

**Proof:**

$$\begin{aligned}
 \text{Var}(X + Y) &= E((X - \mu_X) + (Y - \mu_Y))^2 \\
 &= E(X - \mu_X)^2 + E(Y - \mu_Y)^2 + 2E((X - \mu_X) \cdot (Y - \mu_Y)) \\
 &= \text{Var}(X) + \text{Var}(Y) + 2E(X - \mu_X) \cdot E(Y - \mu_Y) \\
 &= \text{Var}(X) + \text{Var}(Y)
 \end{aligned}$$

$(X - \mu_X)$  generates the same  $\sigma$ -algebra as  $X$  and  $(Y - \mu_Y)$  generates the same  $\sigma$ -algebra as  $Y$  and so are independent.

■

**Example 2.61** A stochastic process - (2.37) continued

By Example 2.37 the p.m.f. of coordinate  $X_i$  is  $p_i$ . The joint p.m.f. of  $\vec{X}$  is, by construction,

$$p_{\vec{X}}(x_1, \dots, x_n) = p_1(x_1) \cdots p_n(x_n).$$

Consequently,

$$p_{\vec{X}}(x_1, \dots, x_n) = p_{X_1}(x_1) \cdots p_{X_n}(x_n).$$

It follows that  $X_1, X_2, \dots, X_n$  are independent random variables since the above implies the events  $\{X_1 = x_1\}, \dots, \{X_n = x_n\}$  are independent for all choices of  $x_1, \dots, x_n$ . Since this is true for every  $n$ , we have by definition that the sequence  $\{X_1, X_2, \dots\}$  is a sequence of independent random variables.

---

We shall have to extend the notion of independence to an infinite sequence of random variables.

**Definition 2.62** The components of a random vector  $\vec{X} = (X_1, X_2, \dots, X_n)$  are independent if  $p_{\vec{X}}(\vec{x}) = p_{X_1}(x_1) \cdots p_{X_n}(x_n)$ . The components of an infinite sequence  $X_1, X_2, \dots$  are independent if every finite subset of components is independent. Finally, a random variable  $Y$  or vector  $\vec{Y}$  is independent of the infinite sequence  $X_1, X_2, \dots$  if  $Y$ , respectively  $\vec{Y}$ , is independent of the vector made from any finite subset of the sequence.

**Example 2.63 ATM networks - (2.26) continued**

The stochastic process  $A_1, A_2, \dots$  is now seen to be a sequence of independent random variables each having p.m.f.  $p$ , which are all independent of the initial queue size  $Q_0$ , which has p.m.f.  $p_0$ . On the other hand, the sequence  $Q_{[t]}$  is certainly not an independent sequence since clearly a large queue at time  $[t]$  means there will be a large queue at time  $[t + 1]$ . It is an interesting question if the departure process  $D_1, D_2, \dots$  is an independent sequence.

---

**Example 2.64 Total service required by a random number of customers**

The number of customers that arrive at a server is a random variable  $N$  with mean  $\mu_N$  and standard deviation  $\sigma_N$ . The service required by a customer is a random variable with mean  $\alpha$  and standard deviation  $\beta$  minutes. Calculate the mean and variance of the number of minutes the server is busy until all the customers are served. We shall suppose the service times of the customers are represented by an independent, identically distributed sequence of random variables  $Y_1, Y_2, \dots$  having mean  $\alpha$  and standard deviation  $\beta$ . Consequently the total service time is represented by

$$T = \sum_{i=1}^N Y_i.$$

We shall also suppose  $N$  is independent of  $\mathcal{F}$  the  $\sigma$ -algebra generated by  $X_1, X_2, \dots$ . Note that  $T(\omega)$  is of the form  $h(N(\omega), \omega)$  where  $h(n, \omega) = \sum_{i=1}^n Y_i$  so using Theorem

2.49

$$\begin{aligned}
ET &= Eh(N, \omega) = \sum_{n \in \mathcal{R}_N} E\left(\sum_{i=1}^n Y_i | N = n\right) P(N = n) \\
&= \sum_{n \in \mathcal{R}_N} E\left(\sum_{i=1}^n Y_i\right) P(N = n) \quad \text{by Corollaries 2.58 and 2.59} \\
&= \sum_{n \in \mathcal{R}_N} n\alpha P(N = n) = \mu_N \alpha - EN \cdot EY_1.
\end{aligned}$$

The calculation of the variance of  $T$  is left as an exercise.

---

## 2.6 General Random Variables

We must extend our definition of expectation to discrete random variables taking on a countable number of values. We will even have occasion to use random variables which are not discrete but rather take on a continuum of values. Definition 2.21 is still valid but such variables do not have a p.m.f. since the probability such a random variable takes on a specific value is 0. Nevertheless the distribution function is always well defined. The extension of the expectation given below is due to H. Lebesgue and involves constructing approximating simple random variables. Further results on the Lebesgue integral are given in the Appendix. This section and the Appendix are rather abstract so at first reading, it would be best to skip over it and concentrate on the proofs for simple random variables.

If  $X \geq 0$  is a random variable defined on a probability space  $\{\Omega, \mathcal{F}, P\}$ , define

$$X_n(\omega) = \begin{cases} \frac{k-1}{2^n} & \text{if } \frac{k-1}{2^n} \leq X(\omega) < \frac{k}{2^n} \text{ where } k = 1, \dots, n2^n \\ n & \text{if } n \leq X(\omega). \end{cases}$$

Clearly, as  $n \rightarrow \infty$  the sequence  $X_n$  of simple random variables increases monotonically to  $X$  as is seen in Figure 2.6. Hence,  $EX_n \uparrow$ .

**Definition 2.65** If  $X \geq 0$  then define  $EX = \lim_{n \rightarrow \infty} EX_n$ . If  $X$  takes both positive and negative values then use the decomposition  $X = X^+ - X^-$  where  $X^+ = \max(0, X)$  and  $X^- = -\min(0, X)$  to define  $EX \equiv \mu_X := EX^+ - EX^-$  whenever it is well defined (integrable); that is whenever  $E|X| = EX^+ + EX^- < \infty$ .

With this definition we have extended the domain of the expectation operator  $E$  associated with the probability  $P$  from simple random variables to the space of integrable random variables.

The following theorem justifies the above definition. A more general form is stated in the Appendix (see Billingsley (1979) for a proof).

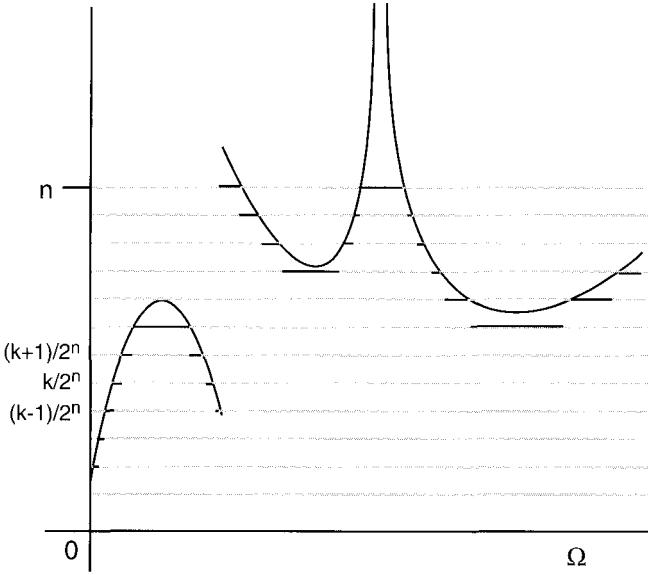

Fig. 2.6 Lebesgue's discrete approximation of a continuous variable.

**Theorem 2.66 (Monotone Convergence)** *If  $Y_n$  is a sequence of random variables such that  $0 \leq Y_n(\omega) \uparrow X(\omega)$  for almost all  $\omega$  then*

$$\lim_{n \rightarrow \infty} EY_n = EX.$$

It follows that the approximating sequence is arbitrary and leads to the same value of the expectation.

Theorems 2.40, 2.41 and 2.42 now follow for general random variables. First consider the case of nonnegative random variables. Approximate by simple random variables for which these theorems have been shown to hold. Now pass to the limit. The signed case holds by additivity.

We can prove the expectation of a discrete random variable taking on a countable number of values is calculated as forecast after Definition 2.38.

**Corollary 2.67** *If  $X$  is a discrete random variable with a p.m.f.  $p_X$  and is integrable, i.e.  $\sum_{x \in \mathcal{R}_X} |x|p_X(x) < \infty$ , then  $EX = \sum_{x \in \mathcal{R}_X} xp_X(x)$ .*

**Proof:** It suffices to prove the Corollary for  $X \geq 0$  since the signed case follows by additivity. Pick a sequence of finite subsets  $A_n$  such that  $A_n \uparrow \mathcal{R}_X$ . Define  $Y_n = X \cdot \chi_{A_n}$ . Clearly  $Y_n$  is simple and  $Y_n \uparrow X$ ; so  $\sum_{x \in A_n} xp_X(x) = EY_n \uparrow EX$  by monotone convergence. On the other hand the sum  $\sum_{x \in \mathcal{R}_X} xp_X(x)$  is defined precisely as the (unique) limit of finite sums like  $\sum_{x \in A_n} xp_X(x)$ . Therefore  $EX = \sum_{x \in \mathcal{R}_X} xp_X(x)$ .  $\blacksquare$

Using this technique we can prove the following Corollary which will be used again and again.

**Corollary 2.68** *If  $X$  is integrable and  $\{A_i : i = 1, 2, \dots\}$  are disjoint subsets in  $\mathcal{F}$  then*

$$E[X \cdot \chi_{\cup_{i=1}^{\infty} A_i}] = \sum_{i=1}^{\infty} E[X \cdot \chi_{A_i}]$$

where, in general, the indicator function  $\chi_A$  of any measurable set  $A$  is defined to be 1 if  $\omega \in A$  and 0 otherwise.

**Proof:** Again it suffices to consider  $X \geq 0$ . Note that

$$Y_n := X \cdot \chi_{\cup_{i=1}^n A_i} \uparrow Y := X \cdot \chi_{\cup_{i=1}^{\infty} A_i}.$$

Moreover, by linearity,  $E[X \cdot \chi_{\cup_{i=1}^n A_i}] = \sum_{i=1}^n E[X \cdot \chi_{A_i}]$ ; so the result follows from monotone convergence.  $\blacksquare$

## 2.7 Independence of General-Random Variables

**Definition 2.69** The  $\sigma$ -algebra  $\mathcal{F}_X$  generated by a random variable  $X$  is the smallest  $\sigma$ -algebra which contains all the events of the form  $\{X \leq x\}$ . More generally, the  $\sigma$ -algebra  $\mathcal{F}_{\vec{X}}$  generated by a random vector  $\vec{X} = (X_1, \dots, X_n)$  is the smallest  $\sigma$ -algebra which containing events of the form  $\{X_1 \leq x_1, \dots, X_n \leq x_n\}$ .

We remark that if  $X$  is discrete then any event in  $\mathcal{F}_X$  is a countable union of events of the form  $\{X = x\}$ . Similarly any event in  $\mathcal{F}_{\vec{X}}$  is a countable union of events like  $\{X_1 = x_1, \dots, X_n = x_n\}$ .

### Definition 2.70

- Two events  $F$  and  $G$  are independent if  $P(F \cap G) = P(F)P(G)$ .
- Two  $\sigma$ -algebras  $\mathcal{F}$  and  $\mathcal{G}$  are independent if all events  $F \in \mathcal{F}$  and all events  $G \in \mathcal{G}$  are independent.
- Similarly  $\sigma$ -algebras  $\mathcal{H}_1, \mathcal{H}_2, \dots, \mathcal{H}_n$  are independent if and only if all  $H_i \in \mathcal{H}_i, i = 1, \dots, n$ ,

$$P(H_1 \cap H_2 \cap \dots \cap H_n) = P(H_1) \cdot P(H_2) \cdot \dots \cdot P(H_n)$$

where  $H_i \in \mathcal{H}_i$ .

- Random variables  $X_1, X_2, \dots, X_n$  are independent if their generated  $\sigma$ -algebras  $\mathcal{F}_{X_i}$  are independent.
- $X$ , respectively  $\vec{X}$ , is independent of  $\mathcal{G}$  if  $\mathcal{F}_X$ , respectively  $\mathcal{F}_{\vec{X}}$ , is independent of  $\mathcal{G}$ .

- Two random vectors  $\vec{X}$  and  $\vec{Y}$  are independent if and only if their generated  $\sigma$ -algebras  $\mathcal{F}_{\vec{X}}$  and  $\mathcal{F}_{\vec{Y}}$  are independent.
- A sequence of random variables is independent if every finite subset is.

Naturally it is impossible to check the independence of two  $\sigma$ -algebras  $\mathcal{F}$  and  $\mathcal{G}$  by checking that all the events  $F \in \mathcal{F}$  and all events  $G \in \mathcal{G}$  are independent. It is enough to show independence of the events which generate these  $\sigma$ -algebras. This point is illustrated in the following Proposition.

**Proposition 2.71** *Let  $\vec{X}$  and  $\vec{Y}$  be vectors of discrete random variables then  $\vec{X}$  and  $\vec{Y}$  are independent if and only if*

$$p_{\vec{X}, \vec{Y}}(\vec{x}, \vec{y}) = p_{\vec{X}}(\vec{x})p_{\vec{Y}}(\vec{y}).$$

**Proof:** Clearly if  $\vec{X}$  and  $\vec{Y}$  are independent

$$\begin{aligned} p_{\vec{X}, \vec{Y}}(\vec{x}, \vec{y}) &= P(\{X_1 = x_1, \dots, X_n = x_n\} \cap \{Y_1 = y_1, \dots, Y_m = y_m\}) \\ &= P(X_1 = x_1, \dots, X_n = x_n) \cdot P(Y_1 = y_1, \dots, Y_m = y_m) \\ &= p_{\vec{X}}(\vec{x})p_{\vec{Y}}(\vec{y}). \end{aligned}$$

On the other hand all events in  $\mathcal{F}_{\vec{X}}$  are unions of events of the form  $\{X_1 = x_1, \dots, X_n = x_n\}$  while events in  $\mathcal{F}_{\vec{Y}}$  are unions of events in  $\{Y_1 = y_1, \dots, Y_m = y_m\}$ . If the joint probability mass function is a product of the marginal probability mass functions, we have, as above, the independence of these generating events. It follows that all events  $F \in \mathcal{F}_{\vec{X}}$  and  $G \in \mathcal{F}_{\vec{Y}}$  are independent since  $F = \cup_{\vec{x} \in K} \{\vec{X} = \vec{x}\}$  and  $G = \cup_{\vec{y} \in L} \{\vec{Y} = \vec{y}\}$  for some countable subsets  $K$  and  $L$ . Hence,

$$\begin{aligned} P(F \cap G) &= \left( \cup_{\vec{x} \in K} \{\vec{X} = \vec{x}\} \right) \cap \left( \cup_{\vec{y} \in L} \{\vec{Y} = \vec{y}\} \right) \\ &= \sum_{\vec{x} \in K} \sum_{\vec{y} \in L} P(\vec{X} = \vec{x}, \vec{Y} = \vec{y}) \\ &= \sum_{\vec{x} \in K} \sum_{\vec{y} \in L} P(\vec{X} = \vec{x})P(\vec{Y} = \vec{y}) \\ &= \sum_{\vec{x} \in K} P(\vec{X} = \vec{x}) \sum_{\vec{y} \in L} P(\vec{Y} = \vec{y}) \\ &= P(F) \cdot P(G). \end{aligned}$$

### Example 2.72 Toss a coin then a die - (2.55) continued

We defined the  $\sigma$ -algebra  $\mathcal{H}$  which represents the partial knowledge about the coin flip and  $\mathcal{G}$  which represents the partial knowledge about the toss of the die. It is easy to check the independence of  $\mathcal{H}$  and  $\mathcal{G}$  when  $P$  is the equiprobability measure.



## 2.8 The Kolmogorov Extension Theorem

In this section we describe a particular stochastic process taking values in a countable state space  $S$  – a sequence of independent random variables. As in Example 2.4, we construct a sample space  $\Omega = S \times S \times S \times \cdots$  and as in Example 2.10, we construct the subalgebra  $\mathcal{F}_n$  of all unions of atomic events of the form

$$A = \{(x_1, x_2, x_3, \dots, x_n)\} \times S \times S \times \cdots\}$$

where  $(x_1, x_2, x_3, \dots, x_n)$  is some specific sequence in  $S$ . As before, we define  $\mathcal{F}$  to be the smallest  $\sigma$ -algebra which contains all the  $\mathcal{F}_n$ .

Many probability measures may be constructed on this canonical space but here we consider the product measure defined below. If  $\{p_i\}$  is a given countable sequence of probability mass functions concentrated on  $S$  then, as in Example 2.18, for  $A$  given above define  $P_n(A) = p_1(x_1) \cdot p_2(x_2) \cdots p_n(x_n)$ . Again the probability of general events in  $\mathcal{F}_n$  is forced by condition (c) in Definition 2.12. The fundamental problem of extending the above probability  $P_n$  defined on each  $\mathcal{F}_n$  to a probability on  $\mathcal{F}$  is resolved by the following theorem which is stated without proof.

**Theorem 2.73 (The Kolmogorov Extension Theorem)** *If a sequence of probability measures  $P_n$  defined on  $\mathcal{F}_n$  satisfies the compatibility condition that  $P_{n+1}(A) = P_n(A)$  if  $A \in \mathcal{F}_n$ , then one may construct a probability measure  $P$  on  $\mathcal{F}$  which agrees with each  $P_n$  on  $\mathcal{F}_n$ .*

The product measures  $P_n$  on  $\mathcal{F}_n$  clearly satisfy the compatibility condition. This follows since any atomic event in  $\mathcal{F}_n$  is of the form  $A := \{x_1, x_2, \dots, x_n\} \times S \times S \times \cdots$  and

$$\begin{aligned} P_{n+1}(A) &= P_{n+1}(\{x_1, x_2, \dots, x_n\} \times S \times S \times \cdots) \\ &= \sum_{x_{n+1} \in S} p_1(x_1) \cdot p_2(x_2) \cdots p_n(x_n) \cdot p_{n+1}(x_{n+1}) \\ &= p_1(x_1) \cdot p_2(x_2) \cdots p_n(x_n) = P_n(A). \end{aligned}$$

By additivity, the compatibility condition may now be verified for all sets in  $\mathcal{F}_n$ .

Hence, by the Kolmogorov extension theorem, there exists a product measure  $P$  on  $\mathcal{F}$ . If, as in Example 2.25, we consider the coordinate functions  $\{X_1, X_2, \dots\}$ , it follows from Example 2.61 that for each  $n$ ,  $X_1, X_2, \dots, X_n$  are independent random variables.

### Example 2.74 An independent sequence - (2.18) continued

By the above, we have constructed a stochastic process of independent random variables  $X_1, X_2, \dots, X_n$  such that the p.m.f. of coordinate  $X_i$  is  $p_i$ .

If  $p_i = p$  for all  $i$ , then the above construction yields an i.i.d. sequence; that is a sequence of independent, identically distributed random variables. A special case is the following.

**Example 2.75 Toss a coin until it turns up heads - (2.33) continued**

In this example the marginal distribution  $p_i$  of  $X_i$  is the same for each  $i$  and

$$\begin{aligned} x &: && 0 & 1 \\ p_i(x) &: && 1 - p & p. \end{aligned}$$

It follows that the product measure  $P_n(A)$  of atomic events  $A \in \mathcal{F}_n$  of the form

$$A = \{(x_1, x_2, x_3, \dots, x_n)\} \times S \times S \times \dots\}$$

where  $x_i$  is some specific sequence of 0's and 1's is precisely

$$P(A) = p^x (1 - p)^{n-x},$$

where  $x$  is the number of heads in the sequence of  $x_i$ 's. This is the answer we predicted in Example 2.17.

---

**Theorem 2.76 Dynkin's Formula** *Let  $\{Z_k, k = 0, 1, \dots\}$  be a sequence of integrable random variables and let  $\tau$  be a stopping time for the sequence  $\mathcal{F}_k^Z = \sigma\{Z_0, \dots, Z_k\}$  of  $\sigma$ -algebras generated by the past of  $Z$  up to time  $k$ . Then, for all  $n \geq 0$ ,*

$$EZ_{\tau \wedge n} = EZ_0 + E\left[\sum_{k=1}^{\tau \wedge n} [E(Z_k | \mathcal{F}_{k-1}^Z) - Z_{k-1}]\right].$$

**Proof:** For each  $n$ ,

$$\begin{aligned} Z_{\tau \wedge n} &= Z_0 + \sum_{k=1}^{\tau \wedge n} (Z_k - Z_{k-1}) \\ &= Z_0 + \sum_{k=1}^n \chi\{\tau \wedge n \geq k\} (Z_k - Z_{k-1}). \end{aligned}$$

Note that  $\{\tau \wedge n \geq k\} = \{\tau \wedge n > k - 1\} \in \mathcal{F}_{k-1}^Z$  so we can take expectations to get

$$\begin{aligned}
 EZ_{\tau \wedge n} &= EZ_0 + E \left[ \sum_{k=1}^n (Z_k - Z_{k-1}) \chi_{\{\tau \wedge n \geq k\}} \right] \\
 &= EZ_0 + E \left[ \sum_{k=1}^n E((Z_k - Z_{k-1}) \chi_{\{\tau \wedge n \geq k\}} | \mathcal{F}_{k-1}^Z) \right] \\
 &= EZ_0 + E \left[ \sum_{k=1}^n (E(Z_k | \mathcal{F}_{k-1}^Z) - Z_{k-1}) \chi_{\{\tau \wedge n \geq k\}} \right] \\
 &= EZ_0 + E \left[ \sum_{k=1}^{\tau \wedge n} [E(Z_k | \mathcal{F}_{k-1}^Z) - Z_{k-1}] \right].
 \end{aligned}$$

■

Suppose  $Z_n = Z_0 + \sum_{k=1}^n X_k$  where  $\{X_k\}$  represent the wins or losses in a series of gambles and  $Z_0$  is our initial fortune. One might hope to design an optimal stopping plan which would lead to a positive expected value for the return up to this stopping time. Unless the gambler is clairvoyant, such a plan which tells you to stop after the  $n^{\text{th}}$  gamble must depend on  $\mathcal{F}_n^Z$  so the plan is a stopping time in the technical sense given here. The above theorem dashes all hope for a money making stopping time. In general, the expected value of any gamble is negative so

$$E(Z_k | \mathcal{F}_{k-1}^Z) - Z_{k-1} = E(Z_k - Z_{k-1} | \mathcal{F}_{k-1}^Z) = E(X_k | \mathcal{F}_{k-1}^Z) \leq 0.$$

If  $\tau$  is bounded then  $\tau \wedge n = \tau$  for some  $n$ . Hence, by Dynkin's formula,  $EZ_\tau \leq EZ_0$ ; i.e. your expected fortune when you stop playing is less than you started with.

The following theorem allows infinite stopping times and again shows gambling doesn't pay.

**Theorem 2.77 Wald's Lemma** *Consider a sequence of independent, identically distributed random variables  $\{X_n\}$ , with common finite expectation  $\mu$ . Let  $\mathcal{F}_n = \sigma(X_1, X_2, \dots, X_n)$ . Suppose  $\tau$  is a stopping time for this sequence such that  $E\tau < \infty$  then*

$$E \sum_{k=1}^{\tau} X_k = \mu E\tau.$$

**Proof:** As above define  $Z_n = \sum_{k=1}^n X_k$ . By Dynkin's formula

$$\begin{aligned} E \sum_{k=1}^{\tau \wedge n} X_k &= E \left[ \sum_{k=1}^{\tau \wedge n} [E(Z_k | \mathcal{F}_{k-1}) - Z_{k-1}] \right] \\ &= E \left[ \sum_{k=1}^{\tau \wedge n} [E(Z_{k-1} + X_k | \mathcal{F}_{k-1}) - Z_{k-1}] \right] = E \left[ \sum_{k=1}^{\tau \wedge n} [E(X_k | \mathcal{F}_{k-1})] \right] \\ &= E \left[ \sum_{k=1}^{\tau \wedge n} \mu \right] \text{ by independence} \\ &= \mu E[\tau \wedge n]. \end{aligned}$$

As  $n$  tends to infinity,  $\mu E[\tau \wedge n]$  tends to  $\mu E\tau$  by the monotone convergence theorem. The convergence

$$E \sum_{k=1}^{\tau \wedge n} X_k \rightarrow E \sum_{k=1}^{\tau} X_k$$

requires a little more work. Clearly  $\sum_{k=1}^{\tau \wedge n} X_k$  tends to  $\sum_{k=1}^{\tau} X_k$  but it is not clear we can take the limit through the expectation symbol.

By the same application of Dynkin's formula as above, with  $E|X_k|$  in place of  $X_k$ ,

$$E \sum_{k=1}^{\tau \wedge n} |X_k| = E|X_1| E[\tau \wedge n].$$

By monotone convergence,

$$E \sum_{k=1}^{\tau} |X_k| = E|X_1| E[\tau \wedge n] < \infty.$$

Since,  $\sum_{k=1}^{\tau \wedge n} X_k \leq \sum_{k=1}^{\tau} |X_k|$  it follows from the dominated convergence theorem in the Appendix that

$$\lim_{n \rightarrow \infty} E \sum_{k=1}^{\tau \wedge n} X_k = E[\tau \wedge n].$$

■

### Example 2.78 Drunkard's walk

Consider a sequence of i.i.d. random variables  $\{X_k\}$  having common probability mass function

$$\begin{array}{rcc} x: & -1 & 1 \\ f(x): & \frac{1}{2} & \frac{1}{2}. \end{array}$$

Suppose we consider sums,  $S_n = \sum_{k=0}^n X_k$  where  $X_0 = x$ .  $S_n$  represents the location of a random walk with independent steps of size  $\{X_k\}$  starting at  $x$ .

Suppose also there are two integers  $L \leq x \leq U$  which are lower and upper bounds for this random walk. Define  $T$  to be

$$T(\omega) = \min_{n \geq 0} (x + S_n \in \{L, U\}).$$

Clearly  $T$  is a stopping time since  $\{T > n\}$  is equivalent to the  $n$  conditions;  $L < x + X_1 < U$ ,  $L < x + X_1 + X_2 < U$  et cetera  $L < x + X_1 + X_2 + \dots + X_n < U$ ; so  $\{T > n\} \in \mathcal{F}_n$  where  $\mathcal{F}_n = \sigma\{X_1, \dots, X_n\}$  (see Definition 2.28).

Now consider the question of whether the random walk starting at  $x$  hits  $L$  before  $U$ . If  $L = 0$  and  $U = 1000000$  then the question takes on additional significance in a gambling context. If we start out with  $x$  dollars and we bet one dollar at a time on the flip of a fair coin, then hitting  $L$  constitutes ruin while hitting  $U$  constitutes walking away a millionaire. It is imperative that we calculate  $f(x) = P(x + S_T = L)$  and  $1 - f(x) = P(x + S_T = U)$ .

Suppose we can apply Wald's Lemma 2.77. If this theorem applies and assuming  $T$  is finite

$$ES_T = E \sum_{k=1}^T X_k = EX \cdot ET = 0,$$

since  $EX = 0$ . Hence,

$$\begin{aligned} x &= E(x + S_T) = LP(x + S_T = L) + UP(x + S_T = U) \\ &= Lf(x) + U(1 - f(x)). \end{aligned}$$

Solving for  $f(x)$  gives  $f(x) = (U - x)/(U - L)$ .

To apply Wald's Lemma we require  $ET < \infty$  and this will imply that  $T$  is finite! We see that  $S_m$  is a binomial random variable which is treated in detail in the next chapter. Letting  $D = U - L$  we can ensure that  $P(|S_m| \leq D) \leq 1 - \alpha < 1$  by picking  $m$  larger than  $D$  since

$$P(|S_m| > D) \geq P(S_m = m) = 1/2^m =: \alpha.$$

Hence uniformly for  $L \leq x \leq U$  we have  $P(L \leq x + S_m \leq U) \leq \beta \equiv 1 - \alpha < 1$ . Consequently starting from any point in  $[L, U]$  there is at most probability  $\beta$  that we stay in the interval up to time  $m$ .

Now let us estimate the probability of staying in the interval at least up to time

$km$ ; that is  $P(T > km)$ . Clearly,

$$\begin{aligned}
 P(T > km) &= P(x + S_n \in \{L, U\}; n = 1, \dots, km) \\
 &\leq P(x + S_n \in \{L, U\}; n = m, 2m, \dots, km) \\
 &\leq P(|S_m| \leq D, |S_{2m} - S_m| \leq D, \dots, |S_{km} - S_{(k-1)m}| \leq D) \\
 &= P(|S_m| \leq D)P(|S_{2m} - S_m| \leq D) \cdots P(|S_{km} - S_{(k-1)m}| \leq D) \\
 &\leq \beta^k
 \end{aligned}$$

using the independence of the  $\{X_k\}$  and the fact that  $S_{im} - S_{(i-1)m}$  has the same distribution as  $S_m$ .

By the above and using Exercise 2.13, we have

$$\begin{aligned}
 ET &= \sum_{k=1}^{\infty} P(T \geq k) \\
 &\leq \sum_{j=1}^{\infty} mP(T \geq (j-1)m) \\
 &\leq \sum_{j=1}^{\infty} m\beta^{j-1} = \frac{m}{1-\beta} < \infty
 \end{aligned}$$

where we used the fact that  $P(T \geq k) \geq P(T \geq j-1)$  for each of the  $m$  terms in the  $j^{\text{th}}$  block:  $\{k : (j-1)m \leq k < jm\}$ . We conclude Wald's Lemma applies and we have our result.

## 2.9 Exercises

Exercise 2.1 Suppose the joint density of  $(X, Y)$  is given by

$$\begin{array}{rcccc}
 f(x, y) & y = -1 & y = 0 & y = 1 & y = 2 \\
 x = -1 & 1/18 & 1/18 & 1/9 & 1/9 \\
 x = 0 & 1/8 & 1/18 & 1/12 & 1/8 \\
 x = 1 & 1/12 & 1/18 & 1/12 & 1/18
 \end{array}$$

- Calculate the probability mass function for  $X$ .
- Calculate  $E(Y|X = x)$ .
- Is  $X$  independent of  $Y$ ?
- Calculate  $E\frac{Y}{X+2}$ .

Exercise 2.2 Suppose the joint density of  $(X, Y)$  is given by

$$\begin{array}{r}
 f(x, y) \quad y = 0 \quad y = 1 \quad y = 2 \\
 x = 1 \quad 1/6 \quad 1/6 \quad 0 \\
 x = 2 \quad 1/6 \quad 0 \quad 1/6 \\
 x = 3 \quad 1/12 \quad 1/6 \quad 1/12
 \end{array}$$

- Calculate the probability mass function for  $X$ .
- Calculate  $P(X < Y)$ .
- Calculate  $f_{Y|X}(y|X = 3)$ .
- Calculate  $E(Y^2|X = 3)$ .
- Calculate  $E((X + Y)^2|X = 3)$ .
- Is  $X$  independent of  $Y$ ? Explain.

Exercise 2.3 A circle is drawn by choosing a radius from the uniform distribution on interval  $(0, 1)$ .

- Find the cumulative probability function for the area of the circle. Calculate the probability that the area of the circle is less than 0.785.
- Find the probability density function for the area of the circle. Find the expected value for this area.

Exercise 2.4 A continuous random variable  $X$  has the probability density function

$$f(x) = \begin{cases} 1/3 & \text{if } -2 < x < -1 \\ k & \text{if } 1 < x < 4 \\ 0 & \text{otherwise.} \end{cases}$$

- Find the value of  $k$ .
- Find the cumulative probability function of  $X$ .
- Find the expected value for  $X$ .
- Let  $Y = X^2 + 2$  find the cumulative probability function of  $Y$  and its expected value.

Exercise 2.5 The purity  $Y$  of each batch of a certain enzyme varies uniformly between 0 to 1 (i.e. 100%). Divide the interval  $[0, 1)$  into  $n$  equal intervals. If  $Y$  falls in an interval with left end point  $k/n$  assign this value to a new random variable  $Y_n$ .

- Show the probability mass function of the random variable  $Y_n$  assigns mass  $1/n$  to the points  $k/n$  for  $k = 0, \dots, n - 1$ .
- The value (in hundreds of dollars) of a batch is determined by the purity and is given by  $V = 10 + 20Y + 4Y^2$ . Find the expected value of  $Y_n$  and of  $V_n = 10 + 20Y_n + 4Y_n^2$ .
- Write down the distribution function  $F_n$  for  $Y_n$ .
- In the next chapter we will see the discrete random variable  $Y_n$  approximates

the continuous random variable  $Y$  having distribution

$$F(s) = \left\{ \begin{array}{ll} 0 & \text{if } y < 0, \\ s & \text{if } 0 \leq s < 1, \\ 1 & \text{if } 1 \leq s. \end{array} \right\}.$$

Show that  $F_n(s)$  converges to  $F(s)$  for all  $s$ .

e) In the next section we will show that the calculation of  $EV$  is much simpler than the calculation of  $EV_n$  since the summation is replaced by the integral

$$\int_{y=0}^1 (10 + 20y + 4y^2) \cdot 1dy \text{ since } Y \text{ has density } 1 \text{ on } [0, 1].$$

Exercise 2.6 Show Theorems 2.40 and 2.41 hold for general random variables.

Exercise 2.7 Show,

$$(\cup_{i=1}^{\infty} E_i) \cap F = \cup_{i=1}^{\infty} (E_i \cap F) \text{ and } (\cap_{i=1}^{\infty} E_i) \cup F = \cap_{i=1}^{\infty} (E_i \cup F).$$

Exercise 2.8 If the  $\sigma$ -algebras  $\mathcal{H}_1, \mathcal{H}_2, \mathcal{H}_3$  are independent show  $H_1 \in \mathcal{H}_1$  is independent of  $H_2 \in \mathcal{H}_2$ .

Exercise 2.9 Prove  $P(\emptyset) = 0$ .

Exercise 2.10 Suppose you are given a list of  $n$  items to sort. The bubble sort starts at the bottom of the list and successively inserts item  $k + 1$  into the list of the  $k$  items already sorted where  $k = 1, \dots, n - 1$ . To insert item  $k + 1$  one must make comparisons starting from the bottom of the  $k$  items already sorted. When the proper place is found the item is inserted. We wish to describe the number of comparisons needed by the bubble sort so we assume all possible lists are equally likely.

- a) Describe an appropriate probability model for the above experiment along with a random variable  $X$  which describes the number of comparisons needed by the bubble sort.
- b) Which sample points give the largest and smallest values of the random variable  $X$ .
- c) Can you write down a recursive formula for the expected value of  $X$  as a function of  $n$ . What is  $EX$ ?
- d) How would you determine the distribution of  $X$ ?

Exercise 2.11 For any sequence of events  $E_i$ , show that we can represent those sample points which are in an infinite number of the  $E_i$ 's by  $\cap_{n=1}^{\infty} \cup_{i=n}^{\infty} E_i$ . We denote this event by  $\limsup E_i$ .

Exercise 2.12 Show that if  $\sum_{i=1}^{\infty} P(E_i) < \infty$  then  $P(\limsup E_i) = 0$ .



Exercise 2.13 If  $N$  is a positive, integer valued random variable having distribution  $F$ , show

$$EN = \sum_{k=0}^{\infty} (1 - F(k)) = \sum_{j=1}^{\infty} P(N \geq j).$$

Exercise 2.14 Let  $X$  be a *nonnegative* random variable and let

$$X_k = \min\{X, k\} = \begin{cases} X & \text{if } X \leq k \\ k & \text{if } X > k, \end{cases}$$

where  $k$  is a given constant. Express the expectation  $E[X_k]$  in terms of the cumulative distribution function  $F(x) = Pr\{X \leq x\}$

Exercise 2.15 If  $X$  has expectation  $\mu_X$ , show  $E(X|X > s) \geq \mu_X$  and  $E(X|X < s) \leq \mu_X$  for any value  $s$ . Do it for discrete variables first. Extend to general random variables if you can.

Exercise 2.16 An urn contains three chips, two marked Good and one marked Bad. Players  $A$  and  $B$  take turns drawing one chip from the urn, that chip being returned to the urn before the next player draws. The winner of the game is the first player to draw a chip marked Good. The game continues until someone wins. If  $A$  draws first, what is his/her probability of winning?

Exercise 2.17 The emergency control circuits on an aircraft are so vital that redundant components are installed to minimize the chance of catastrophic failure. One circuit has two components. The first components has a main A1 and an alternate A2 in case of failure. The second component has a main B1 and an alternate B2. The circuit will fail only if both A1 and A2 or both B1 and B2 have failed. After an emergency use of this circuit all the components of the emergency control circuit is replaced. The times until failure of each of A1 or A2 during an emergency are described by an exponential distribution with mean 4 hours. The times until failure of each of B1 and B2 are described by a normal with mean 6 hours and standard deviation 1 hour (for the moment we don't care what a normal distribution is as long as it can be simulated by Minitab or some other statistical package). Describe how to use a Minitab simulation to calculate the probability the emergency control circuit will not fail during a 10 hour emergency.

Exercise 2.18 Suppose  $Y_1, Y_2, \dots, Y_n$  are independent identically distributed random variables. Suppose that  $U_1, U_2, \dots, U_n$  is a sequence of independent identically distributed uniform random variables independent of the  $Y$ 's. Let  $N(k)$  denote the index of the  $k^{\text{th}}$  largest  $U$ ; i.e. it might be that  $U_3$  is the smallest of all the  $U$ 's so  $N(1) = 3$ . Prove that  $Y_{N(1)}, Y_{N(2)}, \dots, Y_{N(n)}$  is a sequence of independent random variables with the same distribution as  $Y_1, Y_2, \dots, Y_n$ .

Exercise 2.19 A multiple choice examination has fifteen questions, each with five possible answers, only one of which is correct. Suppose that one of the students

taking the examination must answer each question with a complete guess. What is the probability the student gets no questions right?

**Exercise 2.20** Kits of resistances used for making a certain circuit board are produced by factories A and B. We buy 40% of our kits from A and 60% from B. The percentage of defective resistances from factory A is 5% and from B is 2%. A board is picked at random and two resistances are tested. The first resistance is good; so what is the probability these resistances came in a kit from factory A?

**Exercise 2.21** The air rescue service of the armed forces divides the flight path of a downed plane into search sectors. In one mission a search plane will overfly every square kilometer of the designated sector. From past experience one knows however that in one mission there is only a 50% chance of spotting a plane down in a sector of tundra. There is a 40% chance of spotting a plane down in a forested sector and a 15% chance of spotting a plane down in a lake sector.

- A small plane is down in an area containing two sectors of tundra, one lake sector and one forested sector and a priori the plane has an equal chance of being down in any one of the four sectors. The mission director decides to use the first two missions to successively search the sectors of tundra. What is his chance of spotting the downed plane?
- The first two missions have failed. Calculate the (a posteriori) probability the plane is
  - in each of the tundra sectors?
  - in the forest sector?
  - in the lake sector?
- Where should the mission director send the third search mission to maximize the probability of finding the downed plane?

**Exercise 2.22** A disease progresses through two stages - a latent stage and an active stage. If this disease is present in the latent stage, a diagnostic test yields a positive result with 50% probability. If this disease is present in the active stage, this diagnostic test yields a positive result with 90% probability. The test is always negative if the disease is not present in the patient. We know that 4% of the population is afflicted with the latent form of this disease, and that 1% of the population has the active form of the disease. If a patient takes the test and has a positive result, what is the conditional probability that the patient has the active form of the disease?

**Exercise 2.23** In Example 2.78, use Chebyshev's Lemma to show that if  $m$  is sufficiently large then  $P(|S_m| > D) > 0$ .

**Exercise 2.24** Two players, Mr. Jones and Mr. Smith are playing a trick shot in the pool room. Mr. Jones starts and has probability  $P_J$  of making the shot. If he fails Mr. Smith takes over. Mr. Smith has probability  $P_S$  of making the shot and if he fails Mr. Jones takes over again. Calculate the probability that Mr. Jones is

the winner under each of the following scenarios.

- a) The winner is the first to make three trick shots in a row.
- b) The winner is the first to make a total of three trick shots.

For the first question one should define the probability  $V$  that Jones wins and then write a recursive expression for  $V$ . The second question is trickier. Define a function  $V(k, m)$  to be the probability that Jones wins given that Jones has the cue and that Jones now needs  $k$  trick shots while Smith needs  $m$  trick shots to win. Similarly define the function  $U(k, m)$  as the probability that Jones wins given that Smith has the cue and Jones needs  $k$  trick shots to win and Smith needs  $m$ . Now write a recursion for these functions. The recursion can be solved for  $V(3, 3)$  by hand but it is interesting to program this into *Mathematica*.

```
V[0,m_]=1 U[k_,0]=0
V[k_,m_] :=V[k,m]=(1-(1-PJ) (1-PS))^-1
(PJ V[k-1,m]+(1-PJ) PS U[k,m-1])
U[k_,m_] :=U[k,m]=(1-(1-PS) (1-PJ))^-1
(PS U[k,m-1]+(1-PS) PJ V[k-1,m])
Simplify[V[3,3]]
{(PJ^3*(-PJ^2 - 5*PJ*PS + 5*PJ^2*PS - 10*PS^2 +
20*PJ*PS^2 - 10*PJ^2*PS^2 + 12*PS^3 -
21*PJ*PS^3 + 9*PJ^2*PS^3 - 3*PS^4 +
6*PJ*PS^4 - 3*PJ^2*PS^4))/(-PJ - PS + PJ*PS)^5}
```

Exercise 2.25 Mr. Jones has two favorite chocolate shops. One is uptown; one is downtown. Hunger strikes randomly at any time, day or night, and Jones jumps on the first bus going uptown or downtown. Uptown and downtown buses come at a rate of 5 per hour but over time, Mr. Jones finds he visits the uptown shop three times as often as the downtown shop. Describe a scenario which would account for this.

Exercise 2.26 In Example 2.64, we suppose the time  $N$  is the first time  $n$  the service requirement  $Y_n$  exceeds  $q$  at which time the server quits from overwork! Show  $N$  is a stopping time which is dependent on  $\mathcal{F}$ , the  $\sigma$ -algebra generated by the service times  $Y_1, Y_2, \dots$ . Nevertheless, show the expected total service time  $ET$  is still  $EN \cdot EY$ .

Exercise 2.27 Consider the random walk whose step p.m.f. is

$$x: \quad -1 \quad 1$$

$$f(x): \quad \frac{1}{2} \quad \frac{1}{2}$$

like that discussed in Example 2.78. Write down a recursion relation like (5.10) for  $m(x) = E\tau$ , the expected time until the upper or lower boundary is reached, starting with a fortune  $x$ . Find  $m(x)$ .

Exercise 2.28 Generalize the results in Example 2.78 to the case when the step p.m.f. is

$$\begin{array}{rcc} x: & -1 & 1 \\ f(x): & 1-p & p \end{array}$$

Exercise 2.29 Generalize Exercise 2.27 to the case when the step p.m.f. is as given in Exercise 2.28.

Exercise 2.30 Somebody offers to pay you in dollars the sum of the values you roll with one die but each roll cost 3.50. You know the expected value of this game is zero but suppose you decide to using the following *martingale* (a martingale is simply a gambling strategy but to a mathematician the word means a fair game). You will play the game until you roll a six and then stop with this last big payoff. Show that your expected return is still zero.

Exercise 2.31 Somebody offers to pay you in dollars the average of the values you roll with one die but playing the game has a one time cost of 3.50. You know the expected value of this game is zero if you roll a fixed number of times. Can you give a gambling strategy that has a positive expected value?

## Chapter 3

# Variables and Limit Theorems

### 3.1 Discrete Random Variables

Let us suppose each independent observation of a stochastic process is a Bernoulli trial and hence can be classified as success or failure; true or false; heads or tails; 1 or 0. Consider the packet storage example in Chapter 1 which is equivalent to drawing at random with replacement from a box containing three pennies, four nickels and a dime. Suppose drawing a dime (or getting a 10 kilobit packet) is considered a success while anything else is a failure. To model this sequence of  $n$  independent, identically distributed Bernoulli trials we define the product space  $\Omega = \{p_1, p_2, p_3, n_1, n_2, n_3, n_4, d\}^n$ . Let  $\{X_i\}_{i=1}^n$  be a sequence of random variables such that  $X_i(\omega) = 1$  if the  $i^{\text{th}}$  packet associated with the sample point  $\omega \in \Omega$  is  $d$ ;  $X_i(\omega) = 0$  otherwise.  $\mathcal{F}_n = \sigma(X_1, X_2, \dots, X_n)$  and  $P$  is the equiprobability measure so the marginal distributions are  $P(X_i = 1) = 1 - P(X_i = 0) = p = 1/8$ .

Another example is the model for flipping a coin in Example 2.3. There we saw that to model a sequence of  $n$  independent, identically distributed Bernoulli trials we define the product space  $\Omega = \{0, 1\}^n$  on which the coordinate functions  $\{X_k\}_{k=1}^n$  are defined.  $\mathcal{F}_n = \sigma(X_1, X_2, \dots, X_n)$  and  $P$  is the product measure having marginal distributions  $P(X_i = 1) = 1 - P(X_i = 0) = p$ .

Generally we are interested in the number of successes in  $n$  Bernoulli trials and this is modelled by  $B_n = X_1 + X_2 + \dots + X_n$ . Clearly  $\mathcal{R}_{B_n} = \{0, \dots, n\}$ . Moreover

$$\{B_n = k\} = \{(x_1, \dots, x_n) \mid \text{exactly } k \text{ of the } x_i\text{'s are ones}\}.$$

By counting when  $P$  is the equiprobability measure or using the product measure as in Example 2.33;  $P(X_1 = x_1, \dots, X_n = x_n) = p^k(1-p)^{n-k}$  for any sequence of  $x$ 's with exactly  $k$  1's. Moreover the number of different sequences of 0's and 1's with exactly  $k$  1's is  $\binom{n}{k}$ . Hence,

$$P(B_n = k) = \binom{n}{k} p^k (1-p)^{n-k}.$$

It follows that  $B_n$  is a Binomial random variable by the following definition.

**Definition 3.1** A Binomial random variable with parameters  $(n, p)$  has a probability mass function:

$$p_{B_n}(k) = P(B_n = k) = \binom{n}{k} p^k (1-p)^{n-k}$$

for  $k \in \{0, \dots, n\}$ .

In summary then, a Binomial random variable is the number of successes in  $n$  independent, identically distributed random trials, each having probability of success  $p$ . Since a Binomial random variable is a sum of independent Bernoulli random variables it is a simple calculation to verify that the expectation of  $B_n$  is  $np$  and the variance of  $B_n$  is  $np(1-p)$ .

**Example 3.2 ATM networks - (2.5) continued**

If the 5 input trunk lines to the ATM multiplexor are independent and each has probability  $p$  of having a cell at time  $[t]$  then  $A_{[t]}$ , the number of arrivals at time  $[t]$ , is a Binomial random variable with  $n = 5$ . Consequently the mean number of cells arriving at the switch per time unit is  $5p$ . A maximum of one cell is transmitted per time unit. Hence we must have  $5p < 1$  or else the queue will gradually fill up with more and more cells. The time until the switch is overloaded is an important design characteristic which we shall study later.

---

**Example 3.3 No-shows**

A typical application of the Binomial distribution involves the planned overbooking of seats on a business flight. Suppose a plane has 180 seats but past experience has shown that ten percent of the customers with reservations are “no-shows”; that is they don’t show up to check in at flight time. Let us suppose that on a certain airline, it is common practice to accept more than 180 reservations in order to avoid losing revenue. On the other hand the number of reservations should be limited to ensure that the probability of actually leaving behind a dissatisfied customer with a reservation is less than one percent. How many reservations may be taken?

If we suppose that  $n$  reservations are taken, it is reasonable to regard the event that a customer turns up as a Bernoulli trial with probability  $p = 0.9$  of success. The independence of the trials is somewhat dubious – what if a family was travelling together? – but we shall assume independence. The total number to show up may then be represented by a Binomial random variable  $B_n$ , and the probability of leaving at least one dissatisfied customer on the ground is  $P(B_n > 180)$ . This number is given by

$$\sum_{k=181}^n \binom{n}{k} (0.9)^k (0.1)^{n-k}.$$

At this point a short computer program will churn through increasing  $n \geq 180$  until we find the first unacceptable  $n + 1$  such that  $P(B_{n+1} > 180) > 0.01$ . The

value  $n$  is the largest feasible number of reservations to be taken and in fact  $n = 190$ . That number can be determined by using *Mathematica* as in Figure 3.1.

```

fac[0_]:=fac[0]=1
fac[n_]:=fac[n]=n fac[n-1]
binom[n_,k_]:=binom[n,k]=fac[n]/(fac[k] fac[n-k])
unhappy[n_]:=Sum[binom[n,k] 0.9^k 0.1^(n-k),{k,181,n}]
Listplot[Table[{n,unhappy[n]},{n,181,191}]]

```

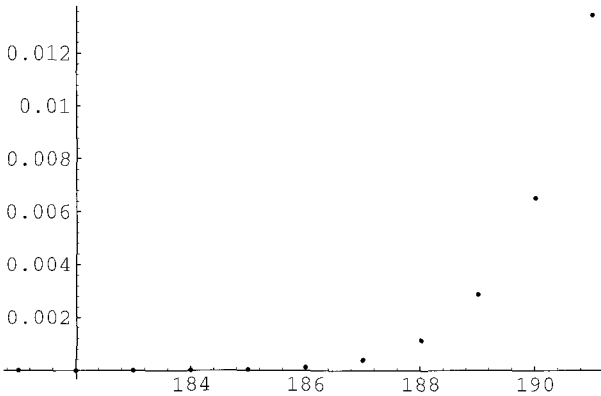

Fig. 3.1 The probability of stranding a customer.

#### Example 3.4 Lot-by-lot sampling inspection by attributes

In Section 1.3 we saw how to implement MIL-STD-105D, a sampling plan designed to assure a desired level of quality from a producer. We now calculate the *OC*-curve associated with a simple sampling plan. One of the major problems in quality control is cost of inspection. When items (like screws or bullets) arrive in lots of size  $N$  it is often impractical to test if each item is defective or nondefective. When the testing is destructive, as in the case of bullets, 100% inspection is obviously impossible. The simplest sampling plan is to select  $n$  (say 20) items at random from the lot and inspect these. If the number of defects  $D$  is less than or equal to the acceptance number  $c$  (say 6) then we accept the lot (but we replace or throw away the defectives we did find). If the number of defectives found in the sample is greater than  $c$ , then we reject the whole lot and send it back to the manufacturer.

To evaluate such a plan we suppose the proportion of defectives in the lot is  $p$ . Since items are chosen at random, if we put imaginary numbers on the items we must choose combinations of  $n$  different items from  $N$ . The number of ways that

$D = k$  is the number of ways of selecting  $k$  from  $Np$  and  $n - k$  from  $N - Np$ . Hence

$$P(D = k) = \frac{\binom{Np}{k} \binom{N - Np}{n - k}}{\binom{N}{n}} \rightarrow \binom{n}{k} p^k (1 - p)^{n - k}$$

as  $N \rightarrow \infty$  (this is left as an exercise). Hence if  $N$  is large enough (but  $p$  is fixed), the distribution of  $D$  is approximately binomial.

```
oc[p_,n_,c_] := Sum[Binomial[n,k] p^k (1-p)^(n-k), {k,0,c}]
Plot[oc[p,20,6], {p,0,1}]
```

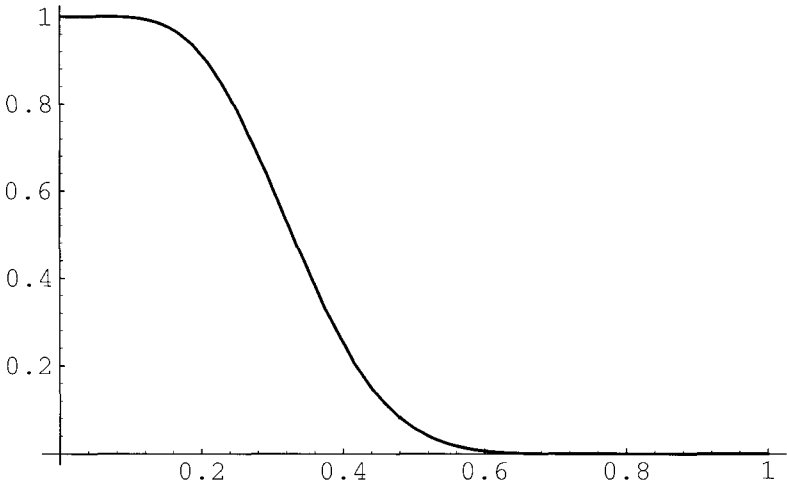

Fig. 3.2 The OC curve with  $n = 20$ ,  $c = 6$ .

To describe the sampling plan we define the operating characteristic (OC) curve as  $OC(p) = P(D \leq c|p)$ ; that is the probability of acceptance as a function of the lot quality. The OC curve is given in Figure 3.2 and with it we can evaluate if the inspection plan protects us sufficiently against poor quality. This plan, for instance, will let lots with 40% defectives go through 20% of the time.

Legend has it that a soldier was ordered to test a lot of shells using a similar sampling plan. His first 7 shells were defective! He therefore asked if he really had to fire off the other 13 from the sample. Logically he should stop his testing at this point and reject the lot. This could have been the birth of sequential sampling methods where the sample size depends on the results of the preceding observations. Naturally the soldier was ordered to fire off all 20 shells.

One mustn't take this anecdote too seriously because many of the quality assurance plans developed by the military are still used today!



Another common random variable counts the number of independent, identically distributed Bernoulli trials required to obtain a first success. Suppose we wish to describe the number of packets coming to the packet storage node depicted in Chapter 1 between successive arrivals of 10 kilobit packets. A packet is a "success" (10 kilobits) with probability  $p = 1/8$  and a failure otherwise. Imagine any infinite sequence of packet arrivals, denoted by  $\omega \in \Omega$ , where

$$\Omega = (x_1, x_2, \dots) : x_i \in \mathcal{L} \text{ where } \mathcal{L} := \{p_1, p_2, p_3, n_1, n_2, n_3, n_4, d\}.$$

We set  $X_i(\omega) = 1$  if the  $i^{\text{th}}$  packet is  $d$  which represents 10 kilobits and  $X_i(\omega) = 0$  otherwise. Define  $T(\omega) = k$  if  $X_1(\omega) = 0, \dots, X_{k-1}(\omega) = 0, X_k(\omega) = 1$ . By counting,  $P(T = k) = (1 - p)^{k-1}p$ .

A more explicit model is given in Example 2.33. The model for such an infinite sequence of Bernoulli trials is given by  $\Omega = \{0, 1\} \times \{0, 1\} \times \dots$  upon which we define the coordinate functions  $\{X_k\}_{k=1}^{\infty}$ . Also  $\mathcal{F}_n = \sigma(X_1, X_2, \dots, X_n)$  and  $P$  is the product measure on  $\mathcal{F}$ , the smallest  $\sigma$ -algebra containing all the  $\mathcal{F}_n$ 's where  $P$  gives marginal distributions  $P(X_i = 1) = 1 - P(X_i = 0) = p$ . As in Example 2.24 we define  $T(\omega) = k$  if  $\omega = (x_1, x_2, \dots, x_{k-1}, 1, \dots)$  where  $x_i = 0$  for  $i = 1, \dots, k-1$ . It follows that  $T$  has a geometric distribution:

**Definition 3.5** A random variable  $T$  is called geometric if

$$p_T(k) = (1 - p)^{k-1}p$$

for  $k \in \mathcal{R}_T = \{1, 2, \dots\}$ .

If  $T$  is geometric then  $P(T > x + y | T > x) = P(T > y)$ . This curious property called *memorylessness*. and it follows immediately from the fact that

$$P(T > k) = P(X_1 = 0, \dots, X_k = 0) = (1 - p)^k.$$

We can appreciate the irony of using the geometric distribution to describe the duration of telephone calls. Even given the fact that a caller has already spoken for  $x$  seconds, the probability he (or she) will speak at least  $y$  seconds more is still  $P(Y > y)$ . It is as if the first  $x$  seconds are forgotten since this is the initial probability of speaking at least  $y$  seconds!

### Example 3.6 Time until $r$ successes

One might consider the number of failures required to obtain  $r$  successes. Clearly the number of trials until the first success is a geometric random variable  $T_1$ . After this first success the number of independent trials until the second success is another identically distributed random variable  $T_2$ . Continuing in this way it is easy to see that the number of failures required before obtaining  $r$  successes may be represented by  $\sum_{i=1}^r T_i - r$ .

The independence of the infinite sequence  $\{T_i; i = 1, 2, \dots\}$  follows since  $\{T_i; i = 1, 2, \dots, n\}$  are independent for any  $n$  and this is true because

$$\begin{aligned}
 & P(T_1 = t_1, T_2 = t_2, \dots, T_n = t_n) \\
 &= P(X_1 = 0, \dots, X_{(t_1-1)} = 0, X_{t_1} = 1, X_{(t_1+1)} = 0, \dots, \\
 &\quad \dots, X_{(t_1+t_2-1)} = 0, X_{(t_1+t_2)} = 1, \dots, X_{(t_1+\dots+t_{n-1}+1)} = 0, \dots \\
 &\quad \dots, X_{(t_1+\dots+t_{n-1})} = 0, X_{(t_1+\dots+t_n)} = 1) \\
 &= P(X_1 = 0, \dots, X_{(t_1-1)} = 0, X_{t_1} = 1) \\
 &\quad \cdot P(X_{(t_1+1)} = 0, \dots, X_{(t_1+t_2-1)} = 0, X_{(t_1+t_2)} = 1) \\
 &\quad \cdots P(X_{(t_1+\dots+t_{n-1}+1)} = 0, \dots, X_{(t_1+\dots+t_{n-1})} = 0, X_{(t_1+\dots+t_n)} = 1) \\
 &= P(T_1 = t_1)P(T_2 = t_2) \dots P(T_n = t_n).
 \end{aligned}$$

On the other hand it is clear that the probability that  $k$  failures occur before the  $r^{\text{th}}$  success is given by the probability that the  $(k+r)^{\text{th}}$  trial is a success and exactly  $k$  of the preceding  $k+r-1$  trials are failures. Hence

$$P\left(\sum_{i=1}^r T_i = k+r\right) = \binom{k+r-1}{k} p^r (1-p)^k.$$

This is an example of the Pascal distribution listed in the table at the end of this chapter.

---

The Poisson is another ubiquitous discrete distribution.

**Definition 3.7** We say a random variable  $N$  has a Poisson distribution with rate  $\lambda$  if  $p_N(k) = e^{-\lambda} \lambda^k / k!$  for  $k \in \mathcal{R}_N = \{0, 1, \dots\}$ .

It is left to Exercise 3.11 to show the expected value and the variance of  $N$  are both  $\lambda$ .

### 3.2 Continuous Random Variables

While we emphasize that, from a practical point of view, only discrete distributions are necessary, nevertheless computational simplifications sometimes follow when we make continuous approximations. The distribution function  $F$  of a discrete random variable is a step function with jumps determined by the probability mass function. Hence if  $f$  is the p.m.f. corresponding to  $F$  then  $F$  jumps up an amount  $f(x)$  at the point  $x$ . A continuous distribution function  $F(t)$  may have no jumps. It is just a continuous nondecreasing function which tends to 0 as  $t \rightarrow -\infty$  and to 1 as  $t \rightarrow \infty$ . The simplest example is the uniform distribution.

**Definition 3.8** The distribution  $F$  defined by

$$F(t) = \begin{cases} 0 & \text{for } t \leq 0 \\ t & \text{for } 0 < t \leq 1 \\ 1 & \text{for } t > 1. \end{cases}$$

is called the continuous uniform distribution on  $[0, 1]$ . A random variable  $X$  with such a distribution is said to be uniformly distributed on  $[0, 1]$ .

**Definition 3.9** We say a sequence of random variables  $\{X_\eta\}$  converges in distribution as  $\eta \rightarrow \infty$  if  $F_{X_\eta}(t) \equiv F_{X_\eta}(t) \rightarrow F(t)$  at each point  $t$  such that  $F$  is continuous at  $t$ . Convergence in distribution is denoted  $F_\eta \Rightarrow F$ .

Consider a discrete uniform random variable  $X_\eta$  on  $[0, 1]$ ; that is

$$p_{X_\eta}\left(\frac{k}{\eta}\right) = \frac{1}{\eta}$$

for  $k = 1, \dots, \eta$ .  $F_{X_\eta}(t)$  measures the probability of points  $\left\{\left(\frac{k}{\eta}\right); \left(\frac{k}{\eta}\right) \leq t\right\}$  so

$$F_{X_\eta}(t) = \begin{cases} 0 & \text{for } t \leq 0 \\ \frac{k-1}{\eta} & \text{for } \frac{k-1}{\eta} \leq t < \frac{k}{\eta} \text{ where } k = 1, \dots, \eta \\ 1 & \text{for } t > 1. \end{cases}$$

As  $\eta \rightarrow \infty$  we see  $F_{X_\eta}(t) \rightarrow F(t)$  at all points  $t$  where  $F$  is the uniform distribution on  $[0, 1]$  defined in Definition 3.8. Consequently we have that  $F_\eta \Rightarrow F$ .

The condition that  $F_\eta(t) \rightarrow F(t)$  at each point  $t$ , such that  $F$  is *continuous* at  $t$ , is just a technical nuisance. Consider for instance a sequence of discrete random variables  $X_\eta$ , with distributions  $F_\eta$ , such that  $P(X_\eta = 0) = 1/2 = P(X_\eta = 1 + 1/\eta)$ . As  $\eta \rightarrow \infty$  it is clear this sequence converges in distribution to the discrete Bernoulli random variable with distribution  $F$ , such that  $P(X = 0) = P(X = 1) = 1/2$ . However,  $F_\eta(1) = 1/2$  and this does not converge to  $F(1)$ . Nevertheless, since 1 is not a point of continuity of  $F$ , this doesn't matter.

Next we consider the continuous approximation to the random variables  $T_\eta/\eta$  where  $T_\eta$  is a geometric random variable with  $p = \frac{\lambda}{\eta}$ . Clearly for  $t \geq 0$

$$\begin{aligned} P\left(\frac{T_\eta}{\eta} \leq t\right) &= 1 - P(T_\eta > t\eta) \\ &= 1 - \left(1 - \frac{\lambda}{\eta}\right)^{\lfloor t\eta \rfloor} \end{aligned}$$

where, in general,  $[s]_-$  denotes the greatest integer in  $s$ . As  $\eta \rightarrow \infty$  the above expression tends to  $1 - \exp(-\lambda t)$  (see Exercise 3.10).

**Definition 3.10**  $F_T$  is an exponential distribution with parameter  $\lambda$  if

$$F_T(t) = \begin{cases} 0 & t \leq 0 \\ 1 - e^{-\lambda t} & t > 0. \end{cases}$$

A random variable  $T$  with distribution  $F_T$  is called an exponential.

Consequently we have shown  $F_{T_\eta/\eta} \Rightarrow F_T$  when  $F_T$  is exponential with parameter  $\lambda$  and we may say the random variable  $T_\eta/\eta$  is approximately exponential.

Most computer languages provide functions like **random** in Pascal which generate pseudo-random uniform variables on  $[0, 1]$ . Each pseudo-random uniform is a discrete uniform distribution which is approximately a continuous uniform as above. A series of pseudo-random numbers generated by such a function will pass most statistical tests for a sample of i.i.d. uniform random variables. To generate a discrete random variable having probability mass function  $p(x)$  for  $x \in \mathcal{R}$  where  $\mathcal{R}$  is finite we need only divide up  $[0, 1]$  into intervals of length  $p(x)$ , one interval for each  $x \in \mathcal{R}$ . Now assign a value  $x$  to a random variable  $X$  if the pseudo-random number falls in the corresponding interval of length  $p(x)$ . This happens with a probability equal to the length of the interval since the pseudo-random number is uniform on  $[0, 1]$ ; that is  $X$  takes the value  $x$  with probability  $p(x)$  as required.

This approach collapses when we consider the problem of simulating a random variable such as the above approximately exponential  $T_\eta/\eta$ . There are simply too many tiny intervals to consider. It is better to simply generate an exponential random variable  $T$ . We first generate a pseudo-random uniform  $U$  then set  $T = (-1/\lambda) \log U$ .  $T$  is clearly nonnegative since  $0 \leq U \leq 1$  and moreover for  $t \geq 0$

$$\begin{aligned} P(T \leq t) &= P\left(-\frac{1}{\lambda} \log U \leq t\right) \\ &= P(U \geq e^{-\lambda t}) \\ &= 1 - e^{-\lambda t} \end{aligned}$$

using the uniform distribution of  $U$ . The extension of this method of simulation to general continuous distributions is given as Exercise 3.3.

The chief application of convergence in distribution is the central limit theorem.

**Theorem 3.11** *Let  $X_1, \dots, X_n$  be independent, identically distributed random variables with common mean  $\mu$  and common variance  $\sigma^2$ . Then letting*

$$Z_n := \frac{\sum_{k=1}^n X_k - n\mu}{\sigma\sqrt{n}}$$

*we have  $F_{Z_n} \Rightarrow F_Z$  where  $F_Z$  is a standard normal distribution having mean 0 and variance 1; that is*

$$F_Z(t) = \int_{-\infty}^t \frac{1}{\sqrt{2\pi}} e^{-\frac{x^2}{2}} dx.$$

**Definition 3.12** If a random variable  $X$  has a distribution  $F_X$  such that

$$F_X(t) = \int_{-\infty}^t \frac{1}{\sqrt{2\pi\sigma^2}} \exp\left(-\frac{(x-\mu)^2}{2\sigma^2}\right)$$

for  $-\infty < t < \infty$  then  $X$  is called a normal random variable with expectation  $\mu$  and variance  $\sigma^2$ . If a random variable  $Z$  is normal and  $\mu = 0$  and  $\sigma = 1$  as in the above Theorem 3.11 then  $Z$  is called a standard normal.

By a simple change of variable in the above integral it is easy to check that  $X$  has the same distribution as  $\mu + \sigma Z$ . In other words, to simulate a general normal random variable it suffices to expand by a factor  $\sigma$  and translate by the mean  $\mu$ .

**Example 3.13 No-shows – (3.3) continued**

Let  $X_k$  be a Bernoulli random variable which takes the value 1 if the  $k^{\text{th}}$  customer shows up and 0 otherwise. We shall assume as before the  $X_k$ 's are i.i.d. with mean  $p = .9$  and variance  $p(1 - p) = .09$ . Hence

$$\begin{aligned} P(B_n > 180) &= P\left(\sum_{k=1}^n X_k > 180\right) \\ &= P\left(\frac{\sum_{k=1}^n X_k - n\mu}{\sigma\sqrt{n}} > \frac{180 - 0.9n}{.3\sqrt{n}}\right) \\ &= P\left(Z_n > \frac{180 - 0.9n}{.3\sqrt{n}}\right) \\ &\approx 1 - F_Z\left(\frac{180 - 0.9n}{.3\sqrt{n}}\right) \end{aligned}$$

using the central limit theorem. Now the 99<sup>th</sup> percentile of the standard normal distribution is given in tables to be 2.33; that is  $P(Z > 2.33) = .01$ . Hence take

$$\frac{180 - 0.9n}{.3\sqrt{n}} \geq 2.33.$$

Letting  $x = \sqrt{n}$  and solving the resulting quadratic equation we get  $x \leq 13.77$ ; that is  $n \leq 189.3$ . Hence we must take  $n = 189$  which is not quite right since the exact calculation gave 190. The central limit theorem is an asymptotic result which only gives approximate results for moderate  $n$ .

---

The continuous distributions we shall deal with all have densities.

**Definition 3.14** If the distribution function,  $F_X$ , of a random variable  $X$  is given by

$$F_X(t) = \int_{-\infty}^t f(x)dx$$

we say  $X$  has a density. These integrals involving densities are assumed to be Riemann integrals and we usually deal with densities which are piecewise continuous.

In particular the density of the standard normal distribution is  $f_Z(z) = \frac{1}{\sqrt{2\pi}} \exp(-z^2/2)$ . Other densities are listed in the table at the end of this chapter.

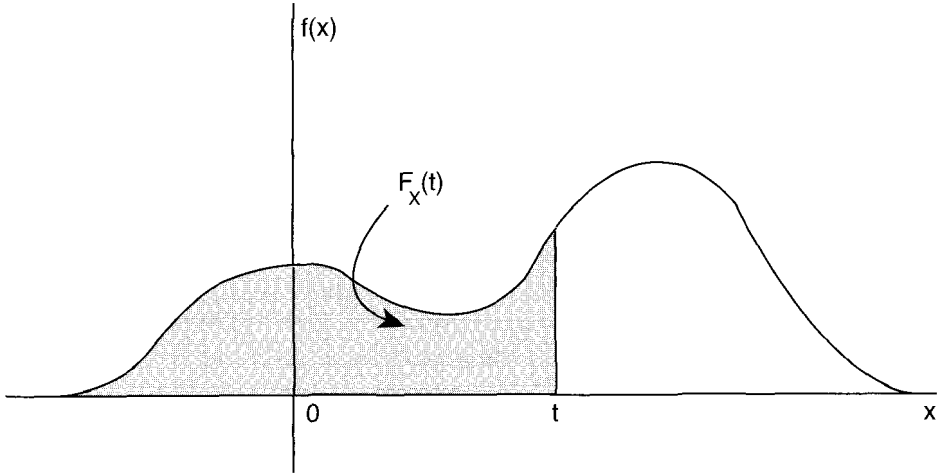

Fig. 3.3  $F_X(t)$  is the area under the density left of  $t$

If a random variable  $X$  has a distribution with density  $f$  then we may connect the definition of expectation described in Definition 2.65 with standard Riemann integrals.

**Theorem 3.15 (The Law of the Unconscious Statistician)**

Suppose  $X$  is a continuous random variable whose distribution has density  $f$ . Suppose, moreover, that  $h$  is a piecewise continuous function on the line. Then, if  $\int_{-\infty}^{\infty} |h(x)|f(x)dx < \infty$ ,

$$Eh(X) = \int_{-\infty}^{\infty} h(x)f(x)dx.$$

**Proof:** For simplicity assume  $h$  is nonnegative. Let  $y = F(x)$  and let  $\bar{h}(y) := h \circ F^{-1}(y)$ . By the change of variable formula for Riemann integrals

$$\int_{-\infty}^{\infty} h(x)f(x)dx = \int_0^1 \bar{h}(y)dy.$$

Let  $U := F(X)$  so  $U$  is uniform on  $[0, 1]$  and  $Eh(X) = E\bar{h}(U)$ . Now by definition,

$$\begin{aligned} E\bar{h}(U) &= \lim_{n \rightarrow \infty} \sum_{k=1}^n \bar{h}\left(\frac{k-1}{n}\right) P\left(\frac{k-1}{n} \leq U < \frac{k}{n}\right) \\ &= \lim_{n \rightarrow \infty} \sum_{k=1}^n \bar{h}\left(\frac{k-1}{n}\right) \frac{1}{n} \\ &= \int_0^1 \bar{h}(y)dy \quad \text{by the definition of a Riemann integral.} \end{aligned}$$

Putting these results together establishes the theorem. ■

Using the Law of the Unconscious Statistician we see continuous random variables may be described in the same way we described discrete random variables. If  $X$  has density  $f$  we may calculate the mean value,  $\mu_X := EX = \int x f(x) dx$  and the variance,  $\sigma_X^2 := E(X - \mu_X)^2 = \int (x - \mu)^2 f(x) dx$ .

We shall not attempt a general description of jointly varying random variables which are not discrete. In particular we will avoid conditional probabilities for these variables. Nevertheless, we can easily describe the joint behavior of independent random variables  $\vec{X} = (X_1, X_2, \dots, X_n)$  with densities  $f_{X_1}, f_{X_2}, \dots, f_{X_n}$ . The joint distribution is defined for any point  $(t_1, t_2, \dots, t_n) \in \mathcal{R}^n$  by

$$\begin{aligned} F_{\vec{X}}(t_1, t_2, \dots, t_n) &= P(X_1 \leq t_1, X_2 \leq t_2, \dots, X_n \leq t_n) \\ &= P(X_1 \leq t_1)P(X_2 \leq t_2) \dots P(X_n \leq t_n) \text{ by independence} \\ &= \int_{-\infty}^{t_1} f_{X_1}(x_1) dx_1 \cdot \int_{-\infty}^{t_2} f_{X_2}(x_2) dx_2 \dots \int_{-\infty}^{t_n} f_{X_n}(x_n) dx_n. \end{aligned}$$

Thus we see the joint distribution may be expressed as the multiple integral of a density function,  $f_{\vec{X}}$ , which is simply the product of the *marginal* densities  $f_{X_1} \cdot f_{X_2} \dots f_{X_n}$ . If we retrace the steps in the proof of the Law of the Unconscious Statistician we get the following extension.

**Corollary 3.16** *Suppose  $(X_1, X_2, \dots, X_n)$  are independent continuous random variables whose distributions have density  $f$ . Let  $h$  be a piecewise continuous function on  $\mathcal{R}^n$ . If*

$$\int_{-\infty}^{\infty} \dots \int_{-\infty}^{\infty} |h(x_1, x_2, \dots, x_n)| f_{X_1}(x_1) \dots f_{X_n}(x_n) dx_1 \dots dx_n < \infty$$

then

$$Eh(\vec{X}) = \int_{-\infty}^{\infty} \dots \int_{-\infty}^{\infty} h(x_1, x_2, \dots, x_n) f_{X_1}(x_1) \dots f_{X_n}(x_n) dx_1 \dots dx_n.$$

**Example 3.17** John Von Neumann proposed the following acceptance rejection method for generating pseudo-random numbers. Suppose we wish to generate a random variable  $X$  having a density  $f_X(x)$ . Suppose we can easily generate independent pseudo-random variables  $U$  and  $Y$  where  $U$  is uniform on  $(0, 1)$  and  $Y$  has density  $h_Y(x); x \in I$ . Finally suppose  $C \geq 1$  is a constant such that  $f_X(x) = Ch_Y(x)g(x)$  where  $0 < g(x) \leq 1$ . We now generate  $U$  and  $Y$  and test if  $U \leq g(Y)$ . If so we accept the value and set  $X = Y$ ; if not we reject the value and we generate another independent pair  $U, Y$  and try again. Using Corollary 3.16 we show in Exercise 3.25 that  $X$  does indeed have density  $f$ ! We could, as a special case, set  $Y$  to be pseudo-uniform on  $I$  so  $g$  is simply a multiple of  $f$ . It is not very efficient however since the number of trials before we get an acceptance has a large expected value.

### 3.3 Generating Functions

**Definition 3.18** The moment generating function  $\phi_X$ , of a random variable  $X$ , is

$$\phi_X(s) := Ee^{sX} = \begin{cases} \sum_{k \in \mathcal{R}_X} e^{sk} p_X(k) & \text{if } X \text{ is discrete} \\ \int_{-\infty}^{\infty} e^{sx} f_X(x) dx & \text{if } X \text{ is continuous.} \end{cases}$$

The probability generating function or z-transform  $\psi_X$ , is sometimes useful for integer valued random variables: For  $z > 0$

$$\psi_X(z) := Ez^X = \sum_{k=0}^{\infty} z^k p_X(k) = \phi_X(\ln(z)).$$

The probability generating function is aptly named and we note that  $\psi_X(1) = 1$ . The moment generating function derives its name from the following theorem.

**Theorem 3.19** If  $\phi_{|X|}(s) < \infty$  for  $-s_0 < s < s_0$  for some  $s_0 > 0$  then

$$\phi_X(s) = \sum_{k=0}^{\infty} \frac{E(X^k)}{k!} s^k, \quad |s| \leq s_0.$$

Hence the moment generating function  $\phi_X$  has derivatives of all orders at  $s = 0$  and

$$\frac{d^k}{ds^k} \phi_X(s) \Big|_{s=0} = E(X^k).$$

**Proof:** By definition

$$e^{sX} = \lim_{n \rightarrow \infty} \sum_{k=0}^n \frac{X^k}{k!} s^k.$$

Taking the expectation of both sides yields the result, although passing the expectation through the limit requires the Dominated Convergence Theorem 9.7. ■

**Example 3.20** Consider a Poisson random variable  $X$  having rate  $\lambda$ . The moment generating function of  $X$  is

$$\begin{aligned} \phi_X(s) &= \sum_{k=0}^{\infty} e^{sk} e^{-\lambda} \frac{\lambda^k}{k!} = e^{-\lambda} \sum_{k=0}^{\infty} \frac{(e^s \lambda)^k}{k!} \\ &= \exp(\lambda(e^s - 1)). \end{aligned}$$

Similarly  $\psi(z) = \exp(\lambda(z - 1))$ . Since  $X$  is positive it is clear  $\phi_{|X|}(s) < \infty$  for all  $s$ . Hence, taking the first derivative we see

$$EX = \frac{d}{ds} \phi_X(s) \Big|_{s=0} = \lambda.$$



**Example 3.21** For the standard normal  $Z$ :

$$\begin{aligned}\phi_Z(s) &= Ee^{sZ} = \int_{-\infty}^{\infty} e^{sx} f_Z(x) dx = \int_{-\infty}^{\infty} e^{sx} \frac{1}{\sqrt{2\pi}} e^{-x^2/2} dx \\ &= e^{s^2/2} \frac{1}{\sqrt{2\pi}} \int_{-\infty}^{\infty} e^{-(x-s)^2/2} dx = e^{s^2/2}\end{aligned}$$

where we used a change of variable

$$\frac{1}{\sqrt{2\pi}} \int_{-\infty}^{\infty} e^{-(x-s)^2/2} dx = \frac{1}{\sqrt{2\pi}} \int_{-\infty}^{\infty} e^{-u^2/2} du = 1$$

since  $\exp(-u^2/2)/(\sqrt{2\pi})$  is a density. Since a normal random variable with mean  $\mu$  and variance  $\sigma^2$  may be represented by  $\mu + \sigma Z$  where  $Z$  is a standard normal it follows that  $\phi_X(s) = \exp(s\mu + s^2\sigma^2/2)$ .

One major advantage of the moment generating function is that it completely characterizes the distribution function:

**Theorem 3.22** *If two random variables have the same moment generating function  $\phi$  such that  $\phi(s) < \infty$  for  $-s_0 < s < s_0$  for some  $s_0 > 0$  then the two variables have the same distribution.*

The proof is beyond the scope of this book. On the other hand, if two nonnegative, integer valued random variables have the same probability generating function having a positive radius of convergence around 0 then by the uniqueness of the power series expansion, the two random variables have the same p.m.f.

Now consider a sequence of independent random variables  $X_1, \dots, X_n$  and denote the sum by  $S$ . The moment generating function of  $S$  is given by

$$\begin{aligned}\phi_S(s) &= E \exp(s(X_1 + \dots + X_n)) \\ &= \prod_{k=1}^n E e^{sX_k} \\ &= \phi_{X_1}(s) \cdots \phi_{X_n}(s).\end{aligned}$$

This follows since for each  $k$ ,  $\exp(sX_k)$  is measurable with respect to  $\sigma(X_k)$  which are independent by hypothesis and consequently the expectation of the product is the product of the expectations using Proposition 2.57. By the same reasoning, the probability generating function of a sum of independent, integer valued random variables is the product of the probability generating functions of the summands.

**Example 3.23** If we now consider the sum of  $n$  independent Poisson random variables  $X_1, \dots, X_n$  having rates  $\lambda_1, \dots, \lambda_n$  then by the above result, the sum  $S$  has a probability generating function given by the product of the probability generating

functions. Hence

$$\psi_S(z) = \prod_{k=1}^n \exp(\lambda_k(z-1)) = \exp\left(\sum_{k=1}^n \lambda_k(z-1)\right).$$

This probability generating function has a positive (in fact infinite) radius of convergence so it completely identifies the distribution of  $S$ . Inspection reveals however that the above probability generating function is precisely that of a Poisson random variable having rate  $\sum_{k=1}^n \lambda_k$ . We conclude that the sum of independent Poisson random variables is again a Poisson random variable.

### Example 3.24 Throw $r$ heads in a row

Consider independent, identically distributed Bernoulli trials  $X_1, X_2, \dots$  each having probability  $p$  of success. Let  $T$  represent the number of tries until we obtain  $r$  successes in a row. The problem is to calculate the moment generating function for  $T$ . Let  $N$  represent the number of tries until the first failure. Clearly  $N$  is a geometric random variable such that  $P(N = k) = p^{k-1}(1-p)$ .

Using conditional expectations,

$$E \exp(sT) = E(E(\exp(sT)|N)).$$

However  $E(\exp(sT)|N = k) = \exp(sr)$  if  $k \geq r + 1$ . Moreover if  $N = k \leq r$  then the first  $k$  tries have been wasted and clearly

$$E(\exp(sT)|N = k) = E \exp(s(T + k)). \quad (3.1)$$

To be more precise we have

$$E(\exp(sT)\chi\{N = k\}) = E(\exp(s(k + T'))\chi\{N = k\})$$

where  $T'$  is the first time  $r$  successes in a row occur with time starting from trial  $k + 1$ . Since the event  $\{N = k\}$  is independent of  $T'$  it follows that

$$E(e^{sT}\chi\{N = k\}) = e^{sk} E(e^{sT'})P(N = k) = e^{sk} E(e^{sT})P(N = k)$$

since  $T$  and  $T'$  clearly have the same distribution. Now divide both sides of the above by  $P(N = k)$  and using Proposition 2.47 we get (3.1).

Now we can calculate:

$$\begin{aligned} Ee^{sT} &= \sum_{k=1}^r e^{sk} E(e^{sT})p^{k-1}(1-p) + \sum_{k=r+1}^{\infty} e^{sr} p^{k-1}(1-p) \\ &= E(e^{sT}) \frac{1-p}{p} \sum_{k=1}^r (pe^s)^k + e^{sr} p^r \\ &= E(e^{sT}) \frac{1-p}{p} \frac{(1 - (pe^s)^r)pe^s}{1 - pe^s} + e^{sr} p^r. \end{aligned}$$

Now solving for  $E \exp sT$  which is on both sides of the above equation and simplifying we get

$$\phi_T(s) = E e^{sT} = \frac{(pe^s)^r (pe^s - 1)}{e^s - 1 - (1-p)e^s (pe^s)^r}.$$

This somewhat formidable expression can now be used to calculate the moments of  $T$ . Taking derivatives gives

$$ET = \frac{1-p^r}{(1-p)p^r}, \quad \text{Var}T = \frac{1}{((1-p)p^r)^2} - \frac{2r+1}{(1-p)p^r} - \frac{p}{(1-p)^2}.$$

It is also instructive to remark that by taking  $x = e^s$  the above expression becomes

$$\sum_{k=1}^{\infty} p_T(k) x^k = \frac{(px)^r (1-px)}{1-x + (1-p)p^r x^{r+1}}.$$

Hence, expanding this rational function out in a power series in  $x$ , we can identify the coefficients  $p_T(k)$  of the term in  $x^k$ . This can be accomplished by remembering that  $1/(1-y) = 1 + y + y^2 + \dots$ . Letting  $y = (x - (1-p)p^r x^{r+1})$  and substituting we can expand this to whatever power we wish (it would help to use *Mathematica* though). For example the coefficient of  $x^r$  is  $p^r$  which corresponds to the probability of immediately having  $r$  successes.

### 3.4 Law of Large Numbers

Another fundamental result is the law of large numbers.

**Theorem 3.25 (Law of large numbers)** *Let  $\{X_n\}$  be independent, identically distributed random variables having common mean  $\mu_X$ . Define the partial sums  $S_n = X_1 + \dots + X_n$ . Then with probability one*

$$\lim_{n \rightarrow \infty} \frac{S_n}{n} = \lim_{n \rightarrow \infty} \frac{1}{n} \sum_{k=1}^n X_k = \mu_X.$$

This is a mathematically pleasing result which as stated is not very practical. First of all to make sense of this result one must construct a probability space  $\{\Omega, \mathcal{F}, P\}$  and then an *infinite* sequence of i.i.d. random variables with a given distribution. Next one must realize that for  $\omega$  chosen from a set of probability 1, the average of the partial sums  $\bar{X}_n(\omega) := S_n(\omega)/n$  does converge to  $\mu_X$  but without a rate of convergence we don't know how big  $n$  should be to ensure  $S_n(\omega)/n$  stays within  $\epsilon$  of  $\mu_X$ . This is particularly unsettling because in principle  $n$  depends on  $\omega$ !

It is perhaps more instructive to state a result that provides a rate of convergence. Suppose the standard deviation of  $X$ ,  $\sigma_X$  is finite. For any  $\epsilon > 0$ ,

$$P\left(\left|\frac{S_n}{n} - \mu\right| > \epsilon\right) \leq \frac{1}{\epsilon^2} E\left(\frac{S_n}{n} - \mu\right)^2 = \frac{1}{n^2 \epsilon^2} E(S_n - n\mu)^2$$

by Chebyshev's inequality (see Theorem 2.44). Next use the fact that the variance of a sum of independent random variables is the sum of the variances so  $E(S_n - n\mu)^2 = n\sigma_X^2$ . We conclude that

$$P\left(\left|\frac{S_n}{n} - \mu\right| > \epsilon\right) \leq \frac{\sigma_X^2}{n\epsilon^2}.$$

Hence, by taking  $n$  large, we can ensure that the probability  $\overline{X}_n$  is within  $\epsilon$  of  $\mu$  is as close to 1 as we like. This result is sometimes called the weak law of large numbers.

### Example 3.26 Continuous sampling inspection by attribute

Consider the problem of inspecting items which arrive not in lots but rather on a conveyor belt in a continuous flow. Each item is classified as defective or nondefective. In many cases the cost of inspecting every item is prohibitive. In the case of destructive testing 100% inspection is impossible. Dodge (1943) proposed the following continuous sampling plan called CSP-1. Start with tight inspection and inspect 100% of the units consecutively and continue in this manner until  $i$  items in succession are nondefective. At this time, as a reward, switch to reduced inspection. Here only one item is inspected out of segments of  $f$  items. This item is selected at random from the  $f$  units in the segment. If the item is nondefective continue with reduced inspection. If, however, the item is defective, as a punishment, switch back to tight inspection and continue until  $i$  nondefective items in succession are found again. We shall assume defective items, once discovered, are removed and replaced by nondefective ones. The case where such items are not replaced can be treated analogously.

The performance of any continuous sampling plan may be described by two parameters. The first relates to the cost of sampling and is given by the AFI or average fraction inspected. The quality of the output is measured by the AOQL, which is defined as the worst average outgoing quality that will result from using a continuous sampling acceptance plan over a long-run period, regardless of present quality. These parameters are calculated under the hypothesis the process is in control; that is the quality of the items may be described as a sequence of i.i.d. Bernoulli random variables with constant parameter  $p$  denoting the probability an item is defective.

Break the process into cycles where one complete cycle starts with tight inspection, continues with reduced inspection and then stops the moment we switch back to tight inspection. Let  $N_1$  represent the number of items inspected until  $i$  items in succession are nondefective. Let  $M_1$  denote the number of segments of  $f$  items that

are subject to reduce inspection until a defective is found. The total length of the first cycle then is  $N_1 + fM_1$  items. Similarly for the  $k^{\text{th}}$  cycle define the length of the tight inspection period to be  $N_k$  items and the number of segments subject to reduced inspection to be  $M_k$ . The length of the  $k^{\text{th}}$  cycle is  $N_k + fM_k$  items. After  $n$  cycles the average fraction inspected

$$\begin{aligned} AFI_n &= \frac{\sum_{k=1}^n (N_k + M_k)}{\sum_{k=1}^n (N_k + fM_k)} \\ &= \frac{\frac{1}{n} \sum_{k=1}^n N_k + \frac{1}{n} \sum_{k=1}^n M_k}{\frac{1}{n} \sum_{k=1}^n N_k + f \frac{1}{n} \sum_{k=1}^n M_k} \\ &\rightarrow \frac{\mu_N + \mu_M}{\mu_N + f\mu_M} \end{aligned}$$

as  $n \rightarrow \infty$  by the law of large numbers where  $\mu_N$  is the common expected value of the  $N$ 's and  $\mu_M$  is the common expected value of the  $M$ 's.

Define  $D_k(1), D_k(2), \dots, D_k(M_k)$  to be the number of defectives missed during the  $M_k$  segments inspected during the reduced inspection period of the  $k^{\text{th}}$  cycle. Call  $\mu_D = ED_k(1)$  for all  $k$ . Since no defectives are missed during the tight inspection period it follows that after  $n$  cycles the  $AOQ_n$  or average outgoing quality is

$$\begin{aligned} AOQ_n &= \frac{\sum_{k=1}^n \sum_{i=1}^{M_k} D_k(i)}{\sum_{k=1}^n (N_k + fM_k)} \\ &= \frac{\frac{1}{n} \sum_{k=1}^n \sum_{i=1}^{M_k} D_k(i)}{\frac{1}{n} \sum_{k=1}^n N_k + f \frac{1}{n} \sum_{k=1}^n M_k} \\ &\rightarrow \frac{\mu_M(f-1)p}{\mu_N + f\mu_M} \end{aligned}$$

again by the law of large numbers since  $E \sum_{i=1}^{M_k} D_k(i) = \mu_M \mu_D = \mu_M(f-1)p$ . This latter result follows from the calculation in Example 2.64 using  $D$ 's instead of  $Y$ 's. We also used the fact that  $\mu_D = (f-1)p$  which follows since  $f-1$  items are left uninspected in each segment so  $D_1(1)$  is a Binomial random variable with parameters  $p$  and  $f-1$ .

The expected length of the tight inspection period was given in Example 3.24. Taking  $r = i$  we get

$$EN_1 = \frac{1 - (1-p)^i}{p(1-p)^i}.$$

Note that here a success is the detection of a defective which has probability  $p$ . The number of segments inspected during the reduced inspection period of a cycle is geometric with probability of success, that is detecting a defective, equal to  $p$  so

$\mu_M = 1/p$ . Hence

$$AFI = \lim_{n \rightarrow \infty} AFI_n = \frac{\frac{1-(1-p)^i}{p(1-p)^i} + \frac{1}{p}}{\frac{1-(1-p)^i}{p(1-p)^i} + \frac{f}{p}}$$

and

$$AOQ = \lim_{n \rightarrow \infty} AOQ_n = \frac{f-1}{\frac{1-(1-p)^i}{p(1-p)^i} + \frac{f}{p}}.$$

One may quibble that the averages should not be taken at the ends of cycles but rather at a sequence of times  $T$  tending to infinity. This question is addressed in the chapter on renewal theory so suffice it to say that the result remains the same. At this point the  $AOQL$  may be determined by maximizing the  $AOQ$  above as a function of  $0 \leq p \leq 1$ . For a given value of  $AOQL$  the best procedure is the one which minimizes the  $AFI$ . Tables have been constructed by Dodge and Romig (1959) for choosing the optimal parameters  $i$  and  $f$ .

### Example 3.27 Control charts

In contrast to the preceding example we are concerned here with controlling the production process, not inspecting it. If we conclude that the process is producing poor quality we stop the process and make adjustments. In a sense we have changed our perspective from the consumer to the producer. Consider the production of electrical resistors. The desired resistance is specified but from past experience we know that there is a random variation due to impurities in the raw materials and small fluctuations in the production environment. These variations are essentially unavoidable and must be distinguished from assignable causes of variation due to operator error or poor quality raw materials. When these assignable or preventable errors occur we say the process is out of control and we must design a scheme to detect this anomaly and correct it as soon as possible.

We say a sequence of quality measurements is in control if the sequence may be modelled by an i.i.d. sequence of random variables. The Shewhart control chart is a tried and true method developed by W. A. Shewhart at the Bell Labs in the 1920's. Suppose the nominal value for a resistance is  $\mu_0 = 1,000$  ohms and past experience has shown that there is an intrinsic standard deviation in our production process of  $\sigma = 50$  ohms. Let us suppose that  $n = 5$  resistors are measured every ten minutes and denote the average of the five resistances measured at the  $i^{\text{th}}$  inspection by  $\bar{X}_i$  and let the difference between the largest and smallest of these five resistances be denoted by  $R_i$ , the range. If the process is in control the deviations from the nominal value are the result of many tiny random errors with no bias; that is with mean 0. By the central limit theorem we would expect the sum of these errors to follow the normal distribution and certainly the average of five resistances should further reinforce this trend. Consequently the distribution of  $\bar{X}_i$  is approximately

normal with mean  $\mu_0$  and standard deviation  $\sigma/\sqrt{n}$ . The Shewhart  $\bar{x}$ -chart given in figure 3.4 consists of three control lines: the nominal value  $\mu_0$  and the 3- $\sigma$  limits,  $\mu_0 - 3\sigma/\sqrt{n}$  and  $\mu_0 + 3\sigma/\sqrt{n}$ .

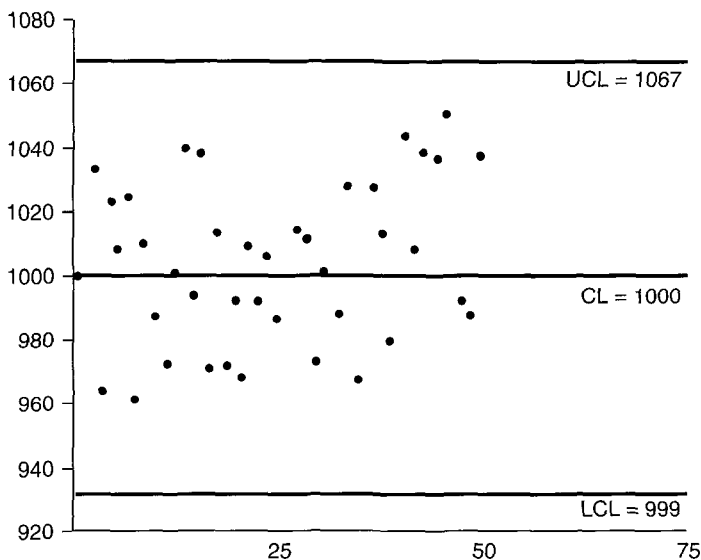
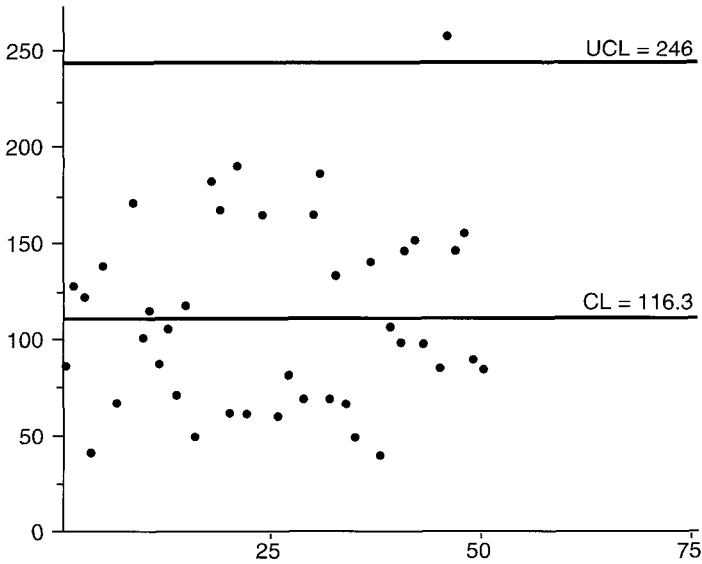

Fig. 3.4  $\bar{x}$ -chart.

The observed values  $\bar{x}_i$  have been plotted. The values are in control up to observation 39 but from observation 40 on the mean is shifted to 1,020. When the process is in control there is a probability of 0.0026 of falling outside the control lines. The real out-of-control situation starting at observation 40 is not detected. The poor performance of the Shewhart chart in the above example should be contrasted with the performance of the more modern Cusum procedure discussed in Example 5.36, which quickly detects the out-of-control situation after observation 40.

An increase in standard deviation of the observations may indicate the production process is becoming more variable and this may be even worse than a systematic shift of the process mean! The  $r$ -chart is designed to detect this increase in the standard deviation. The values  $R_i$  are plotted on the  $r$ -chart in Figure 3.5. For any inspection, the difference  $R := x_{(n)} - x_{(1)}$  between the largest and smallest resistances has a distribution which only depends on  $n$  and  $\sigma$  since

$$\begin{aligned}
 P(R \leq t) &= P(X_{(n)} - X_{(1)} \leq t) \\
 &= P\left(\sigma \left[ \frac{(X_{(n)} - \mu_0)}{\sigma} - \frac{(X_{(1)} - \mu_0)}{\sigma} \right] \leq t\right) \\
 &= P(Z_{(n)} - Z_{(1)} \leq t/\sigma)
 \end{aligned}$$

Fig. 3.5  $r$ -chart.

where  $Z_{(n)}$  and  $Z_{(1)}$  are the largest and smallest of  $n$  standard normals.

The expected value and standard deviation of  $Z_{(n)} - Z_{(1)}$  can be tabulated for each  $n$  and are usually denoted by  $d_2$  and  $d_3$  by the quality control engineers. Therefore the mean along with the upper and lower three standard deviation limits of  $R$  are given by  $\sigma d_2$ ,  $\sigma(d_2 - 3d_3)$  and  $\sigma(d_2 + 3d_3)$  respectively. These control lines have been plotted on the  $r$ -chart although the lower control limit is omitted since it is negative. Again, an out-of-control alarm should be signalled as soon as an  $R_i$  falls outside the control lines. This means the variability of the process has suddenly changed and one should determine the assignable cause of this deviation. In this example the range values are always in control since the standard deviation is constant but as luck would have it, an out-of-control alarm is signalled at the 45th hour (in fact a false alarm) and the quality control team would start looking for the assignable cause of the error.

There is a trade-off involved in process control. We wish to detect the out-of-control situation as soon as possible but on the other hand we don't want to signal too many false alarms! The  $3\text{-}\sigma$  limits will eventually be exceeded even for a process in control, just by chance variability. This will generate a false alarm which will slow down production. In Exercise 3.26 the run length of an in-control process before a false alarm is shown to have a geometric distribution and the average run length ARL is given. When the process is out-of-control the run length is also shown to be geometric with a much shorter run average run length.

One should not leave the impression that the Shewhart chart is a useless antique! On the contrary, it is a subtle statistical tool which is especially useful when one



doesn't have nominal values for  $\mu$  and  $\sigma$ . Imagine the assembly line has been retooled. Suppose we make 250 observations in 50 blocks of  $n = 5$  and we wish to decide if the production mechanism is under control. The empirical Shewhart chart is a good method to use.

For block  $i$  calculate the average,  $\bar{X}_i$ , of  $n = 5$  observations. Take the average of these 50  $\bar{X}_i$ 's and call this  $\bar{\bar{X}}$ . This is a good estimate for the unknown value  $\mu$ . Next, for block  $i$ , calculate the estimated standard deviation

$$\hat{\sigma}_i = \sqrt{\frac{\sum_{k=1}^n (X_k - \bar{X})^2}{n}}$$

Clearly,

$$\begin{aligned} \frac{\hat{\sigma}}{\sigma} &= \sqrt{\frac{\sum_{k=1}^n \left( \frac{(X_k - \mu)}{\sigma} - \frac{(\bar{X} - \mu)}{\sigma} \right)^2}{n}} \\ &= \sqrt{\frac{\sum_{k=1}^n (Z_k - \bar{Z})^2}{n}}. \end{aligned}$$

Let the expectation of  $\sqrt{\sum_{k=1}^n (Z_k - \bar{Z})^2 / n}$  be denoted by  $c_2 \equiv c_2(n)$ . The quality control engineers have produced tables for these constants; for instance  $c_5 = 0.8407$ . This means  $E\hat{\sigma}/c_2 = \sigma$ . Define  $\bar{\sigma} = (\hat{\sigma}_1 + \hat{\sigma}_2 + \dots + \hat{\sigma}_n)/n$  which means  $\bar{\sigma}/c_2$  is an unbiased estimator of  $\sigma$ , the unknown standard deviation of the process.

We can now draw the center line,  $\bar{\bar{X}}$ , and the 3 sigma lower and upper control limits,

$$\text{LCL} = \bar{\bar{X}} - 3 \frac{\bar{\sigma}}{c_2 \sqrt{n}} \quad \text{and} \quad \text{UCL} = \bar{\bar{X}} + 3 \frac{\bar{\sigma}}{c_2 \sqrt{n}}$$

along with all the block averages  $\bar{X}_i$ . This is called the empirical Shewhart chart. If the process is really in control none of the block averages should fall outside the control limits. Moreover the control engineers have various symptoms of loss of control which can quickly be identified from the Shewhart chart. For instance, an alarm would be signalled if 7 points in a row were on one side of the center line or if 7 successive points plot as an upward or downward trend. The control engineer could even detect if an operator is overcorrecting the production process if the control points see-saw above and below the center line. Figure 3.6 is the empirical Shewhart chart of 50 blocks of  $n = 5$  observations of a normal with mean 1000 and standard deviation  $\sigma = 50$ .

There are also charts to test if the standard deviation of the observations is in control. This amounts to plotting  $\hat{\sigma}_i$  along with the center line at  $\bar{\sigma}$  and the 3 sigma limits. We won't do this here because other statistical techniques are certainly better. Indeed the whole question of whether or not the limits should be calculated based on assuming the observations are normal is open to debate. The  $\bar{x}$ -chart

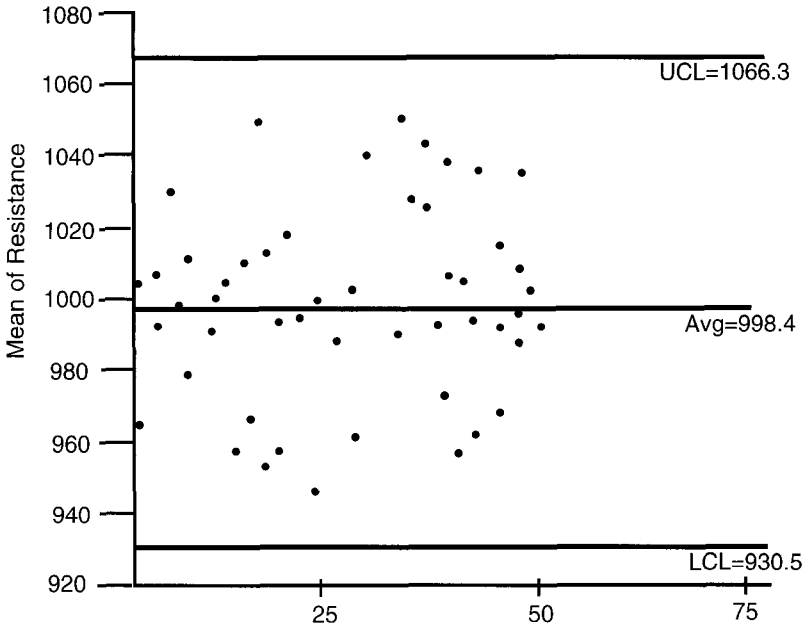

Fig. 3.6 The empirical  $\bar{x}$ -chart.

works well because the distribution of the average already tends to be normal by the central limit theorem. Nevertheless the statistical significance of an alarm is uncertain. The control limits for the  $\bar{\sigma}$ -chart are even more problematic. More research is needed to provide charts which are not so heavily dependent on the normality assumption.

### 3.5 Exercises

**Exercise 3.1** Complete Example 3.4. Show that the number of defectives drawn without replacement from a large lot is approximately Binomial.

**Exercise 3.2** A random variable  $X$  has a Poisson distribution with mean  $\lambda$ . Given  $X = n$ ,  $B$  has a binomial distribution with parameters  $n$  and  $p$ .

a) Using the relation  $E \exp(tB) = E(E(\exp(tB)|X))$  and the uniqueness of moment generating functions show that  $B$  is Poisson with mean  $\lambda p$ .

b) Show that  $B$  and  $X - B$  are independent and find the conditional distribution of  $X$  given  $B = b$ .

**Exercise 3.3** If  $F$  is a continuous distribution function define the inverse function  $F^{-1}(s) = \min\{t : F(t) \geq s\}$ . Let  $U$  be a pseudo-random uniform on  $[0, 1]$ . Show

$F^{-1}(U)$  has distribution  $F$ .

Exercise 3.4 Show that if  $X$  is a positive random variable then

$$EX = \int_0^{\infty} (1 - F(x))dx.$$

Exercise 3.5 The lifetime of an electronic component has a density given by

$$f(x) = \begin{cases} 1/5000 & \text{for } 0 \leq x \leq 1000 \text{ hours} \\ \frac{4}{20000} \exp(-(x - 1000)/4000) & \text{for } x > 1000 \text{ hours} \end{cases}$$

- Calculate the expected lifetime of the component.
- What is the probability the component last longer than 3000 hours?
- Write down the moment generating function of this density.
- If I measure the lifetime of 1,000 of these components and plot a histogram will the histogram follow the normal curve?
- If I take the average of these 1,000 components what value will I obtain approximately?
- Four of these components are wired into a parallel redundant system. What the probability at least one works after 3,000 hours.

Exercise 3.6 A machine cuts pipe in lengths of 40 inches with a standard deviation of 0.60 inches. We take a sample of 100 pieces of pipe. We draw the sample histogram and calculate the average length of the pipes in this sample.

- Will the sample histogram will necessarily follow the normal curve?
- Calculate the expected value of the sample average.
- Calculate the standard deviation of the sample average.

Exercise 3.7 We say a random variable  $X$  with distribution  $F$  is stochastically larger than a random variable  $Y$  with distribution  $G$  if for all  $t$ ,  $F(t) \leq G(t)$ . Construct  $X = F^{-1}(U)$  and  $Y = G^{-1}(U)$  using the same pseudo-random uniform  $U$  on  $[0, 1]$ . Show  $X \geq Y$  and show that if  $u$  is an increasing function then  $Eu(Y) \leq Eu(X)$ .

Exercise 3.8 Let  $W$  be the number of white balls selected when  $k$  balls are chosen at random from an urn containing  $n$  white balls and  $m$  black balls. Calculate  $EW$  and  $Var(W)$ .

Exercise 3.9 A company has  $N$  employees who must submit a sample for drug testing. The  $N$  employees are divided into  $n$  groups of  $k$  people and everybody is sampled. The samples from the people in a group are mixed together and tested. If the  $k$  people in the group are free of drugs then the test for the mixture will be negative. If the mixture tests positive however, the remaining portion of the sample from each member of the group is tested individually. In this case a total of  $k + 1$  tests are done. Past experience shows one should expect a proportion  $p$  of the employees are drug users.

- a) What is the probability any given group will test positive?
- b) What is the expected number of tests done?
- c) If  $p$  is small, find the  $k$  which approximately minimizes the expectation in part b).

Exercise 3.10 Note that  $[t\eta]_- = t\eta - \delta$  where  $0 \leq \delta < 1$ . Use this, plus the fact that  $\lim_{s \rightarrow \infty} (1 - \lambda/s)^s = \exp(-\lambda)$  to complete the proof that  $T_\eta/\eta$  converges in distribution to the exponential where  $T_\eta$  is the geometric with  $p = \lambda/\eta$ .

Exercise 3.11 Calculate the expectation and variance of a Poisson random variable with rate  $\lambda$ .

Exercise 3.12 Let  $X_1, X_2, X_3, \dots, X_n$  be independent normal random variables such that  $X_i$  has mean  $\mu_i$  and variance  $\sigma_i^2$  for  $i = 1, 2, \dots, n$ . Show that the sum  $S_n = X_1 + \dots + X_n$  is a normal random variable with mean  $\mu_1 + \mu_2 + \dots + \mu_n$  and variance  $\sigma_1^2 + \sigma_2^2 + \dots + \sigma_n^2$ .

Exercise 3.13 A tiny circuit board must physically hold 3 components across the back end of the board which measures 10mm. Unfortunately the size of the components are highly variable. All three follow a normal distribution. The first component has a mean of 4mm with a standard deviation of .5mm; the second and third have a mean of 2mm with a standard deviation of .4mm.

- a) What is the distribution of the combined length of three components taken at random from their respective populations.
- b) What proportion of the circuit boards are defective because the components were improperly mounted because they didn't fit?

Exercise 3.14 Let  $X_1, X_2, X_3, \dots, X_n$  be independent random variables uniformly distributed on  $[0, 1]$ . Show that the distribution function of the maximum,  $S = \max\{X_1, X_2, \dots, X_n\}$  is  $F_S(t) = t^n$  for  $0 \leq t \leq 1$ .

Exercise 3.15 Prove that  $E(X^2) \geq (E(X))^2$ . In general, if  $\phi$  is a nondecreasing function, use the mean value theorem to show  $E\phi(X) \geq \phi(E(X))$ . Now check that the function  $x^2$  has a nondecreasing derivative.

Exercise 3.16 Let  $X$  and  $Y$  be independent Poisson random variables with means  $\lambda_X$  and  $\lambda_Y$ . Calculate the conditional distribution of  $X$ , given  $X + Y = n$ .

Exercise 3.17 Let  $X$  and  $Y$  be independent exponential random variables with means  $\lambda_X$  and  $\lambda_Y$ . Find the distribution of  $\min\{X, Y\}$  and  $\max\{X, Y\}$ , as well as the respective means and variances.

Exercise 3.18 Calculate all the moments of a Poisson random variable with mean  $\lambda$  using the moment generating function.

Exercise 3.19 Let  $X$  be a random variable with probability generating function  $p_X(z)$ . Find the generating functions of  $X + 1$  and  $3X$ .

**Exercise 3.20** Let  $v_k$  be the probability that the number of successes in  $k$  Bernoulli trials is divisible by 3. Find a recursion relation for  $v_k$  (express  $v_k$  in terms of  $v_{k-1}, v_{k-2}, \dots$ ) and from this find the generating function  $p(z) := \sum_k v_k z^k$ .

**Exercise 3.21** Let  $X$  be a nonnegative random variable with distribution function  $F$  and let  $X_c = \min\{X, c\}$  where  $c$  is a given constant. Express the expectation  $EX_c$  in terms of the distribution function  $F$ .

**Exercise 3.22** Let  $X$  be a nonnegative integer-valued random variable with probability generating function  $\phi(s) = \sum_{n=0}^{\infty} a_n s^n$ . After observing  $X$ , then perform  $X$  independent Bernoulli trials each having probability  $p$  of success. Let  $T$  represent the resulting number of successes.

- Determine the probability generating function of  $T$ .
- If  $X$  is a Poisson random variable with mean  $\lambda$  show  $T$  is also Poisson with mean  $\lambda p$ .

**Exercise 3.23** 100 pieces arrive at a computer controlled drill each requiring a different number of operations. Each operation involves orienting the piece and placing the drill bit and takes 3 minutes. Empirical experience has shown the probability mass function of the number of operations is given (approximately) by the following table. What is the chance the batch of 100 pieces will take more than 16 hours to process?

$x$ operations:	1	2	3	4	5
probability $f(x)$ :	.1	.2	.2	.3	.2

**Exercise 3.24** Suppose hamburger is packaged by machine into patties but due to the variable fat content the actual weight of a patty can be described by a normal random variable  $N(\mu, (0.2)^2)$  where  $\mu$  is the desired mean weight of a patty which can be typed into the controls of the packaging machine. We package 50 patties into a carton but if the net weight of the carton is less than 200 ounces the carton must be rejected. What weight  $\mu$  should we type into the controls to ensure that only 1 carton in 100 is rejected?

**Exercise 3.25** Show that the acceptance-rejection method works by using Bayes' formula:

$$F_X(x) = P(Y \leq t | U \leq g(Y)) = \frac{P(Y \leq t; U \leq g(Y))}{P(U \leq g(Y))}$$

However,

$$\begin{aligned} P(Y \leq t; U \leq g(Y)) &= \int_{-\infty}^{\infty} \int_0^1 \chi_{y \leq t, u \leq g(y)}(u, y) f_Y(y) du dy \\ &= \int_{-\infty}^t g(y) f_Y(y) dy \end{aligned}$$

using Corollary 3.16. Calculate  $P(U \leq g(Y))$  in a similar way. Now identify the density of  $F_X$ .

**Exercise 3.26** Show that the run length of the Shewhart  $\bar{x}$  procedure is geometric and calculate the expected run length, both when the process is in-control and when the process is out-of-control and the mean value of the process has changed to  $\mu_1$ .

**Exercise 3.27** The number of customers entering the Price Club on a given day is a Poisson random variable with mean  $\lambda = 2,000$ . The amount of money spent by any customer is approximately normally distributed with a mean of 110 dollars and a standard deviation of 20 dollars. Find the mean and standard deviation of the amount of money that the store takes in on a given day.

**Exercise 3.28** Stocking a remote oil drilling camp is impossible during the summer months except by air. During the winter an ice road can be built but this requires a convoy headed by a big plow to clear the snow followed by the heavy trucks (which may or may not fall through the ice!). Past experience has shown that the fuel consumed by the convoy varies from kilometer to kilometer depending on snow and ice conditions but on average 28 liters is consumed per kilometer with a standard deviation of 5 liters. Suppose the return trip is 600 kilometers. Obviously if more fuel is carried less cargo can be hauled. On the other hand running out would be a major embarrassment! How much fuel should be allocated at the start of the trip to be 99.9% sure there is enough to make the return trip?

**Exercise 3.29** We can generate normal random variables with the following version of the rejection method.

- (1) Generate a uniform random variable  $U_1$  on  $[0, 1]$ .
- (2) Set  $X_1 = -\ln(U_1)$ .
- (3) Next generate another independent uniform random variable  $U_2$  on  $[0, 1]$ . If  $U_2 \leq \exp(-(X_1 - 1)^2/2)$ , accept  $X_1$ . Otherwise reject  $X_1$  and go back to step (a).
- (4) Generate a sign of plus or minus for  $X_1$  with equal probability and output  $X$  as  $X_1$  with the resulting sign.

a) Show that if  $X_1$  is accepted, then its density corresponds to the density of the absolute value of a standard normal random variable (with mean 0 and variance 1).

b) Show that  $X$  is a standard normal random variable.

## Discrete Distributions

Discrete Distribution	p.m.f. $p(x)$	moment generating function $\phi(t)$	mean	variance
Binomial $(n, p)$	$\binom{n}{k} p^k (1-p)^{n-k}$ $k = 0, 1, \dots, n$	$(pe^t + q)^n$ $q = 1 - p$	$np$	$npq$
Poisson rate $\lambda$	$e^{-\lambda} \frac{\lambda^k}{k!}$	$e^{\lambda(e^t - 1)}$	$\lambda$	$\lambda$
Geometric	$p(1-p)^{k-1}$ $0 \leq p \leq 1$ $k = 1, 2, 3, \dots$	$\frac{pe^t}{1 - (1-p)e^t}$	$\frac{1}{p}$	$\frac{1-p}{p^2}$
Pascal	$\binom{\alpha + k - 1}{k} p^\alpha (1-p)^k$ $\alpha > 0, 0 < p < 1$ $k = 0, 1, \dots$	$(\frac{p}{1-qs})^\alpha$ $q = 1 - p$	$\frac{\alpha q}{p}$	$\frac{\alpha q}{p^2}$

## Continuous Distributions

Continuous Distribution	density $f(x)$	moment generating function $\phi(t)$	mean	variance
Uniform over $(a, b)$	$\frac{1}{a-b}, a < x < b$	$\frac{e^{tb} - e^{ta}}{t(b-a)}$	$\frac{a+b}{2}$	$\frac{(b-a)^2}{12}$
Exponential	$\lambda e^{-\lambda x}$ $\lambda > 0, x \geq 0$	$\frac{\lambda}{\lambda - t}$	$\frac{1}{\lambda}$	$\frac{1}{\lambda^2}$
Normal	$\frac{1}{\sqrt{2\pi\sigma^2}} e^{-(x-\mu)^2/2\sigma^2}$ $-\infty < x < \infty$	$\exp(\mu t + \frac{\sigma^2 t^2}{2})$	$\mu$	$\sigma^2$
Gamma	$\frac{\lambda}{\Gamma(\alpha)} (\lambda x)^{\alpha-1} e^{-\lambda x}$ $\lambda > 0, \alpha > 0$ $x > 0$	$\frac{\lambda^\alpha}{(\lambda - t)^\alpha}$	$\frac{\alpha}{\lambda}$	$\frac{\alpha}{\lambda^2}$



## Chapter 4

# The Poisson Process

### 4.1 Introduction

We describe the structure of a simple point process on the line. Consider a strictly increasing sequence of random variables  $\{T_n^P\}_{n=-\infty}^{\infty}$  defined on a probability space  $\{\Omega, \mathcal{F}, P\}$ . The  $\{T_n^P\}_{n=-\infty}^{\infty}$  represent the arrival times of certain events – say an incoming signal to a network measured in seconds before or after some fixed time which we take to be 0. We suppose that  $T_0^P \leq 0 < T_1^P$ . The sojourn times or interarrival times relative to 0 are denoted:

$$X_n^P = \begin{cases} T_n^P - T_{n-1}^P & n \geq 2 \\ T_1^P & n = 1 \\ -T_0^P & n = 0 \\ T_{n+1}^P - T_n^P & n \leq -1. \end{cases}$$

Except for  $n = 0$  and  $n = 1$ , the  $X_n^P$  represents the interarrival time between the  $n - 1^{th}$  and the  $n^{th}$  arrivals.  $X_0^P$  represents the time since the last arrival before 0, and  $X_1^P$  represents the time until the first arrival after time 0. If multiple arrivals

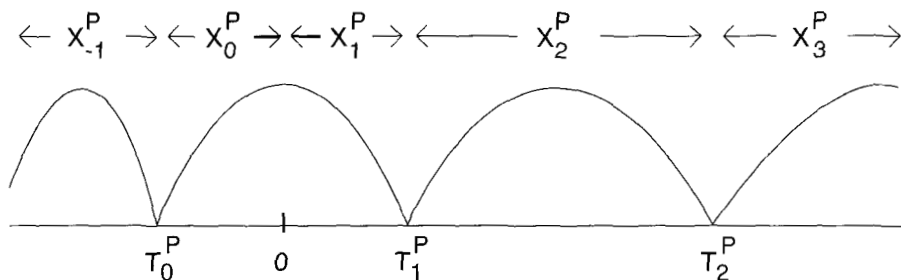

Fig. 4.1 A trajectory of a simple point process

may occur at the same  $\{T_n^P\}$ , we call this a multiple point process. We shall give a description of these point processes under various dependence structures.

Throughout we shall assume that time is measured in seconds with nanosecond precision; hence precise to nine decimal places. The operation of converting any time  $t$  measured in seconds to nanoseconds and rounding up to the next nanosecond is denoted by  $\hat{t}$ . Square brackets denote rounding up to the next integer but they sometimes remind us when a measurement is in nanoseconds. Hence  $t$  seconds converts to  $\hat{t} = [\eta t]$  nanoseconds where  $\eta$  is the number of nanoseconds in a second.

We take the point of view that no simulation or real measurement is taken in smaller units than nanoseconds so there are no continuous time processes. This will not preclude us from making continuous approximations as we shall see.

## 4.2 Bernoulli Point Processes

In the time interval between  $[k-1]$  and  $[k]$  nanoseconds we perform an independent Bernoulli trial  $L_k$ , to decide the presence (with probability  $p_k$ ) or absence (with probability  $1-p_k$ ) of an arrival by the end of that interval of time. Let  $\{\hat{T}_n\}_{n=-\infty}^{\infty}$  denote the arrival times generated. These times measured in seconds are denoted  $\{T_n\}_{n=-\infty}^{\infty}$ .

**Definition 4.1** For the point process of arrival times generated by independent Bernoulli trials, define

$$N(t) = n - 1 \text{ if } T_{n-1} \leq t < T_n.$$

Also define  $\langle N(t) \rangle = EN(t) = \sum_{0 < k \leq [\eta t]} p_k$ . For each  $t$ ,  $N(t)$  counts the number of successes between time 0 and time  $t$ , and is called a discrete Bernoulli process with compensator  $\langle N(t) \rangle$ . If  $p_k = p = \lambda/\eta$  for all  $k$  then  $N(t)$  is called a discrete homogeneous Bernoulli process having rate  $\lambda$ .

### Example 4.2 Call acceptance

When a customer dials a telephone number a signaling network called SS7 must decide if there is enough spare capacity to accept this new call and set up a route across the network. This may mean searching for a route through a sequence of switches right across the country. The telephone system has been designed so that a customer has a low probability of getting the dreaded busy signal. This means sufficient capacity has been installed to service the projected stochastic demand. Let's examine a simple model for determining this required capacity.

The first step is to model the incoming calls at an access switch. Thousands of customers are wired to this switch and in a given nanosecond any one of those customers may pick up the phone to start a call. Let the probability of this event be  $p = \lambda/\eta$ . Since the customers make their decision to place a call independently of each other it is reasonable to assume that what happens in one nanosecond does not

influence what happens in another nanosecond. Consequently in each nanosecond a Bernoulli trial with probability of success  $p$  determines if a call arrives or not. This means the incoming calls can be modelled as a Bernoulli point process  $N(t)$  with rate  $\lambda$ .

The telephone companies have done a thorough statistical analysis of the distribution  $G$  of the duration of telephone calls. The average duration of calls has been estimated and the histogram of call durations has been plotted. In fact this histogram has historically been well approximated by either a geometric or exponential distribution. This is surprising and embarrassing because the both these distributions are memoryless as seen in Propositions 4.4 and 4.5 below. This means that a conversation which has already lasted 10 minutes say, will (statistically) carry on as if it just started.

The next step is to model the stochastic process  $Q(t)$  which represents the number of calls in progress at time  $t$  given calls arrive according to a Bernoulli process with rate  $\lambda$  and stay connected for a random duration having distribution  $G$  and mean  $\mu_G$ . Let  $Y_k$  be the duration of the  $k^{\text{th}}$  call. Hence,

$$Q(t) = \sum_{k=1}^{N(t)} \chi\{Y_k > t - T_k\}$$

where  $\chi\{Y_k > t - T_k\}$  is the indicator random variable which takes the value 1 if the  $k^{\text{th}}$  call is still in progress at time  $t$  and 0 otherwise.

The distribution of  $Q(t)$  is of paramount importance for determining the desired trunk capacity. The telephone company must put in place sufficient capacity  $K$  so that  $P(Q(t) > K)$  is sufficiently small. In recent years the advent of modems, faxes and the internet have drastically altered the distribution of call durations. Some researchers believe the distribution of  $G$  now has an infinite variance and there is a wave of new research to analyze the impact on the perform of the telephone network.

---

Bernoulli processes can occur in contexts.

### Example 4.3 Control charts for attributes

Character recognition systems scan printed text letter by letter in order to convert old books to an electronic format for archival purposes. Smudges on the page sometimes cause scanning errors. Let  $p$  be the probability a given letter is read in error. We will assume  $\eta$  is 10000 letters (about 5 pages) and  $p = \lambda/\eta$  so  $\lambda$  represents the mean number of errors per ten thousand letters. Let  $N[x]$  represent the number of errors after reading in the first  $x$  letters in a book. It is not unreasonable to assume an error in scanning one letter doesn't affect the scanning of other letters (although it might be argued that adjacent letters are affected). Consequently we can assume  $N$  is a Bernoulli process with rate  $\lambda$ .

---

**Proposition 4.4** For a homogeneous Bernoulli process

- The interarrival times  $\{\hat{X}_n\}_{n=1}^\infty$  are i.i.d. with a geometric distribution having parameter  $p$ .
- $N(0) = 0$ .
- $N(t)$  has independent increments; that is  $\{N(t_2) - N(t_1) = i\}$  and  $\{N(s_2) - N(s_1) = j\}$  are independent events if  $(t_1, t_2]$  and  $(s_1, s_2]$  are disjoint intervals.
- $N(t)$  has stationary increments; that is

$$P(N(s+t) - N(s) = i) = P(N(t) = i) = \binom{[\eta t]}{i} p^i (1-p)^{[\eta t]-i}.$$

**Proof:**  $\hat{X}_1 = [k]$  if the Bernoulli trials in time intervals  $\{([i-1], [i]]\}_{i=1}^{k-1}$  are failures and the trial in time interval  $([k-1], [k])$  is a success. Hence  $\hat{X}_1$  has a geometric distribution. The independence of  $\{\hat{X}_n\}_{n=2}^\infty$  and  $\hat{X}_1$  follows from the independence of the Bernoulli trials. For example

$$\begin{aligned} P(\hat{X}_1 = [x_1], \hat{X}_2 = [x_2]) &= P(L_1 = 0, \dots, L_{x_1-1} = 0, L_{x_1} = 1, \\ &\quad L_{x_1+1} = 0, \dots, L_{x_1+x_2-1} = 0, L_{x_1+x_2} = 1) \\ &= P(L_1 = 0, \dots, L_{x_1-1} = 0, L_{x_1} = 1) \\ &\quad \cdot P(L_{x_1+1} = 0, \dots, L_{x_1+x_2-1} = 0, L_{x_1+x_2} = 1) \\ &= P(\hat{X}_1 = [x_1])P(\hat{X}_2 = [x_2]). \end{aligned}$$

Moreover,  $P(\hat{X}_1 = [x_1], \hat{X}_2 = [x_2]) = (1-p)^{[x_1]-1} p (1-p)^{[x_2]-1} p$  so it also follows that  $\hat{X}_2$  is geometric. Next  $N(0) = 0$  by definition. Moreover  $\{N(t_2) - N(t_1) = i\}$  depends only on trials in time interval  $(\hat{t}_1, \hat{t}_2]$  while  $\{N(s_2) - N(s_1) = j\}$  depends only on the trials in time interval  $(\hat{s}_1, \hat{s}_2]$ . Since these intervals are disjoint, the corresponding trials are independent and so the increments are independent. Finally  $N(s+t) - N(s)$  is a binomial random variable since it is the number of successes in  $\eta t$  trials. ■

Proposition 4.4 gives an alternate means of generating the points of a homogeneous Bernoulli process. Construct an i.i.d. sequence of geometric random variables with parameter  $p$  and use these to define  $\hat{T}_1$  and the interarrival times  $\{\hat{X}_n\}_{n=2}^\infty$ .

We recall that the geometric distribution has a *memorylessness* property:

**Proposition 4.5**

$$P(T_1 > x+y | T_1 > x) = P(T_1 > y)$$

**Proof:** Since  $P(\hat{T}_1 > \hat{y}) = (1-p)^{\hat{y}}$  the proof is obvious. ■

The *memorylessness* property is particularly strange when one considers that we have used the geometric distribution to model the duration of telephone calls!

Another consequence of the *memorylessness* property is the following waiting time paradox. At any time  $t$  (including  $t = 0$ ), denote the forward recurrence time or excess time at  $t$  by

$$Y(t) = T_{N(t)+1} - t.$$

If the mean interarrival time is  $1/\lambda$  seconds (or  $[\eta/\lambda]$  nanoseconds) then one might expect that the mean excess time at  $t$  is one half of this. On the other hand,

$$P(\hat{Y}(t) > [x]) = P(L_{\hat{t}+[1]} = 0, \dots, L_{\hat{t}+[x]} = 0) = (1 - p)^{[x]}$$

which reflects the fact that no matter what happened up to  $t$  the excess at  $t$ ,  $\hat{Y}(t)$ , is a geometric random variable with mean  $[1/p] = [\eta/\lambda]$  nanoseconds or  $1/\lambda$  seconds.

To reconcile these two calculations it suffices to remark that the interarrival period to which  $t$  belongs, namely  $T_{N(t)+1} - T_{N(t)}$ , is the sum of  $Y(t)$  and the age at  $t$  defined by

$$Z(t) := t - T_{N(t)}.$$

Now,

$$P(\hat{Z}(t) > [z]) = P(L_{\hat{t}} = 0, \dots, L_{\hat{t}-[z]} = 0) = (1 - p)^{([z]+1)}$$

where  $[z] = 0, 1, 2, \dots$ ; hence  $\hat{Z}(t) + 1$  is also a geometric random variable with mean  $[1/p] = [\eta/\lambda]$  nanoseconds or  $1/\lambda$  seconds. It follows that the mean of  $Z(t)$  is  $[\eta/\lambda - 1]$  nanoseconds or  $1/\lambda - 1/\eta$  seconds. Hence half the mean of  $T_{N(t)+1} - T_{N(t)} = Z(t) + Y(t)$  is about  $1/\lambda$  seconds.

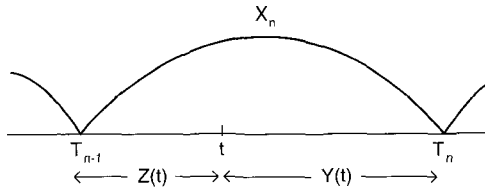

Fig. 4.2 The age and excess time at  $t$ .

The fact is that by selecting the interarrival period containing a specific time we have favored the selection of a longer interarrival period since longer periods have a higher probability of containing a given time point. An arbitrary interarrival period has a geometric distribution as shown in Proposition 4.4 but an interarrival period chosen to contain a given time point is approximately twice as long. This is the explanation of the waiting time paradox. This point will be considered again in Chapter 6 on renewal theory.

### 4.3 The Poisson Process

Throughout this section we shall assume that  $N$  is a homogeneous Bernoulli process with rate  $\lambda$ . This process is characterized by Proposition 4.4 but the Binomial expression

$$P(N(t) = i) = \binom{[\eta t]}{i} p^i (1-p)^{[\eta t]-i}$$

is rather hard to calculate. Our first step is to find an approximation for this expression for large  $\eta$ . Recall that  $p = \lambda/\eta$  and assume  $t$  is an integer number of nanoseconds.

$$\begin{aligned} & \binom{[\eta t]}{i} p^i (1-p)^{[\eta t]-i} \\ &= \frac{\eta t (\eta t - 1) \cdots (\eta t - i + 1)}{i!} \frac{p^i}{(1-p)^i} (1-p)^{\eta t} \\ &= \frac{\eta t}{\eta t} \frac{\eta t - 1}{\eta t} \cdots \frac{\eta t - i + 1}{\eta t} \left( \frac{1}{1 - \lambda/\eta} \right)^i \frac{(\eta t p)^i}{i!} \left( 1 - \frac{\lambda t}{\eta t} \right)^{\eta t} \\ &\sim \frac{(\lambda t)^i}{i!} \exp(-\lambda t) \end{aligned}$$

since in general  $(1 - \alpha/N)^N \rightarrow \exp(-\alpha)$  as  $N \rightarrow \infty$ . We conclude the distribution of  $N(t)$  is approximately *Poisson* with a mean  $\lambda t$ .

In Corollary 4.24 we will show much more. In fact we will show the homogeneous Bernoulli process  $N$  is approximated by a Poisson process with rate  $\lambda$ . For the moment however let's just calculate probabilities with the above Poisson approximation and neglect the error (which is order of  $1/\eta$ ).

**Example 4.6** Consider a homogeneous Bernoulli process representing the arrival of telephone calls at a wire center at a rate of  $\lambda = 5$  calls per second. For arguments sake let's calculate the probability three calls arrive in the first second and ten calls arrive in the first four seconds. In order to calculate  $P(N(1) = 3 \text{ and } N(4) = 10)$  we first recognize that

$$P(N(1) = 3 \text{ and } N(4) = 10) = P(N(1) = 3, N(4) - N(1) = 7)$$

which by the property of independent increments is

$$P(N(1) = 3)P(N(4) - N(1) = 7).$$

Next, by stationarity,  $P(N(4) - N(1) = 7) = P(N(3) = 7)$ . Hence, using the Poisson approximation of binomial random variables,

$$P(N(1) = 3 \text{ and } N(4) = 10) \approx e^{-5} \frac{5^3}{3!} e^{-15} \frac{15^7}{7!}.$$

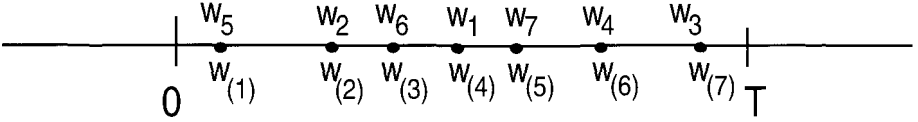

Fig. 4.3 Order statistics.

We now construct the continuous Poisson process mentioned above which with high probability agrees with the Bernoulli process on each nanosecond. For the moment we consider only the homogeneous case. We generalize the basic property that the arrival times of the Bernoulli process occur independently and uniformly across a given time period.

**Definition 4.7** Let  $W_1, W_2, \dots, W_n$  be a sequence of independent, identically distributed random variables with a continuous distribution. Then the  $k^{th}$  smallest,  $W_{(k)}$ , is called the  $k^{th}$  order statistic.

$W_{(k)}$  does not have the same distribution as the  $W$ 's, as shown in Figure 4.3. For instance, the largest or  $n^{th}$  order statistic  $W_{(n)}$  is certainly bigger than a typical  $W$ . In fact

$$P(W_{(n)} \leq t) = P(W_1 \leq t, \dots, W_n \leq t) = F_W^n(t)$$

where  $F_W$  is the common distribution function of  $W$ 's.

**Definition 4.8** We construct a continuous Poisson process  $N^P(t)$  on  $0 \leq t \leq T$  by first constructing a Poisson variable with mean  $\lambda T$  called  $N^P(T)$ . Then, conditioned on the event  $N^P(T) = n$ , the distribution of the arrival times  $\{T_k^P : k = 1, \dots, n\}$  is that of the order statistics of  $n$  i.i.d. uniform random variables on  $[0, T]$ .

This means that given there are  $n$  arrivals in  $[0, T]$ , the arrival times are uniformly and independently distributed on  $[0, T]$ . It is easy to see (do Exercise 4.4) that the joint density of  $\{T_k^P : k = 1, \dots, n\}$  is

$$f_{T_1^P, T_2^P, \dots, T_n^P}(t_1, t_2, \dots, t_n) = \frac{n!}{T^n} \text{ on } 0 \leq t_1 < t_2 < \dots < t_n \leq T. \quad (4.1)$$

This construction immediately leads to the following characterization which is the analogue of Proposition 4.4 for the Bernoulli process.

**Proposition 4.9** A process  $N^P$  is a homogeneous Poisson process on  $[0, T]$  if and only if

- $N^P(0) = 0$ .
- $N^P(t)$  has independent increments; that is  $\{N^P(t_2) - N^P(t_1) = i\}$  and  $\{N^P(s_2) - N^P(s_1) = j\}$  are independent events if  $(t_1, t_2]$  and  $(s_1, s_2]$  are disjoint intervals.

- $N^P$  has stationary Poisson increments; that is

$$P(N^P(s+t) - N^P(s) = i) = P(N^P(t) = i) = e^{-\lambda t} \frac{(\lambda t)^i}{i!}.$$

**Proof:** Let  $N^P$  be a continuous Poisson process. Since uniform random variables are continuous there is no chance  $T_1^P = 0$  so  $N^P(0) = 0$ . Next, let  $\Delta t := t_2 - t_1$  and  $\Delta s := s_2 - s_1$ . Conditioning on  $N^P(T) = n$  we see that  $i$  of the arrivals must fall in the interval  $(t_1, t_2]$  and this has probability  $(\Delta t/T)^i$ ;  $j$  must fall in  $(s_1, s_2]$  and this has probability  $(\Delta s/T)^j$  and the rest must fall outside both intervals with probability  $(T - \Delta t - \Delta s/T)^{n-i-j}$ . The points which fall in the prescribed intervals may be chosen randomly from the  $n$  arrivals. Hence

$$\begin{aligned} & P(N^P(t_2) - N^P(t_1) = i, N^P(s_2) - N^P(s_1) = j) \\ &= \sum_{n=i+j}^{\infty} \frac{n!}{i! j! (n-i-j)!} \left(\frac{\Delta t}{T}\right)^i \left(\frac{\Delta s}{T}\right)^j \left(\frac{T - \Delta t - \Delta s}{T}\right)^{n-i-j} e^{-\lambda T} \frac{(\lambda T)^n}{n!} \\ &= \left(\frac{\Delta t}{T}\right)^i \left(\frac{\Delta s}{T}\right)^j (\lambda T)^{i+j} \exp(-\lambda T) \frac{1}{i! j!} \sum_{n=i+j}^{\infty} \frac{[\lambda T (\frac{T - \Delta t - \Delta s}{T})]^{n-i-j}}{(n-i-j)!} \\ &= \frac{(\lambda \Delta t)^i}{i!} \frac{(\lambda \Delta s)^j}{j!} \exp(-\lambda T) \exp(\lambda(T - \Delta t - \Delta s)) \\ &= \frac{(\lambda \Delta t)^i}{i!} \exp(-\lambda \Delta t) \frac{(\lambda \Delta s)^j}{j!} \exp(-\lambda \Delta s). \end{aligned}$$

It follows that  $N^P(t_2) - N^P(t_1)$  and  $N^P(s_2) - N^P(s_1)$  are independent Poisson random variables with means  $\lambda(t_2 - t_1)$  and  $\lambda(s_2 - s_1)$  respectively.

The proof of the converse that a processes with independent Poisson increments is a Poisson processes is delayed until Section 4.5. ■

If a number of independent Poisson processes with the same rate  $\lambda$  on contiguous disjoint intervals are stuck together to create a point process on one large interval then by Proposition 4.9 this process has independent Poisson increments and must therefore be a Poisson process. Similarly, the points of a Poisson process generated on  $[0, T]$  which fall in a subinterval  $[0, t]$  form a Poisson process on  $[0, t]$ .

Our definition of a Poisson process can be generalized to multidimensional spaces. Given a continuous probability distribution on a region  $S$  in  $R^2$  say, we can first generate a Poisson random variable  $N$  and if  $N = n$  distribute  $n$  points in an i.i.d fashion over the region  $S$  according to the given distribution. If the given distribution is the uniform distribution this gives a homogeneous Poisson process on the region  $S$ .

Definition 4.8 provides a means of testing if a point process is Poisson. Given  $N(T) = n$ , test if the  $n$  arrival times are uniformly distributed on the interval  $[0, T]$ . The best choice is probably a Kolmogorov-Smirnov test for the distribution function  $F(s) = s/T$  for  $0 \leq s \leq T$ . This test is described in Feller Volume II (1971).



**Example 4.10** Consider the superposition of two independent Poisson processes  $N_1^P$  and  $N_2^P$  on  $[0, T]$ . These two processes may represent the arrivals of calls at a telephone switch from two cities so  $I(t) := N_1^P(t) + N_2^P(t)$  represents the total number of calls by time  $t$  where  $0 \leq t \leq T$ . The distribution of  $I(T)$  is Poisson since  $I(T)$  is the sum of  $N_1^P(T)$  and  $N_2^P(T)$ , which are independent Poisson random variables. Next, given that  $I(T) = n$ ,  $N_1^P(T)$  and  $N_2^P(T)$  take values  $i$  and  $j$  where  $i + j = n$  according to a multinomial distribution. Regardless of the values  $i$  and  $j$ , the points of the process  $N_1^P$  given  $N_1^P(T) = i$  are independent and uniformly distributed on  $[0, T]$ . The same is true of the points of  $N_2^P$ . Consequently, given  $I(T) = n$ , the points of the process  $I(t)$  are independent and uniformly distributed on  $[0, T]$ . By definition this means  $I(t)$  is a Poisson process.

---

#### 4.4 Applications of the Poisson Process

We have already seen that the distribution of the homogeneous Bernoulli process  $N(t)$  is binomial and that this distribution may be approximated by a Poisson distribution with parameter  $\lambda$ . This approximation goes much further and we can state the following result which follows from Theorem 4.22:

**Theorem 4.11** *A homogeneous Bernoulli process  $N(s) \equiv N[\eta s]$  on  $[0, t]$  may be coupled to a Poisson process  $N^P(s) \equiv N^P[\eta s]$  on  $[0, t]$  such that*

$$P(N[k] \neq N^P[k] \text{ for some } k \leq \lceil \eta t \rceil) \leq \frac{\lambda^2 t}{\eta}.$$

Since  $\eta$  is so large the above theorem implies the two processes  $N$  and  $N^P$  agree on the nanoseconds with very high probability over intervals of reasonable length.

#### Example 4.12 Call acceptance - (4.2) continued

As we have seen, when the possibility of a call arrival in any given instant (nanosecond) is very small ( $\lambda/\eta$ ) and the arrivals are independent, then we have an approximate Bernoulli process with rate  $\lambda$ . Theorem 4.11 implies that this Bernoulli process is approximately a Poisson process with rate  $\lambda$ . Hence it is not at all unreasonable to assume that the arrival stream of calls to a telephone exchange is Poisson. Let us suppose that any call requires a certain service time which has a general distribution  $G$ . Finally, for simplicity, we shall assume that every call is immediately served; that is, there are an infinite number of servers. Such a queue is called an  $M/G/\infty$  queue.

Let the number of calls by time  $t$  be represented by a Poisson process  $N^P(t)$ . Let us calculate the moment generating function of  $Q(t)$ , the number of calls in progress

at time  $t$ . As in Example 4.2 let  $Y_k$  be the service period of the  $k^{\text{th}}$  customer. Hence,

$$Q(t) = \sum_{k=1}^{N^P(t)} \chi\{Y_k > t - T_k^P\}$$

Next

$$\phi_{Q(t)}(s) = Ee^{sQ(t)} = \sum_{n=0}^{\infty} E\left(e^{sQ(t)} | N^P(t) = n\right) P(N^P(t) = n). \quad (4.2)$$

Now from Definition 4.8, given  $N^P(t) = n$ , the conditional distribution of the arrival times  $\{T_k^P : k = 1, \dots, n\}$  is that of the order statistics of  $n$  i.i.d. uniforms on  $[0, t]$ ; say  $\{U_k : k = 1, \dots, n\}$ ; i.e.  $T_k^P = U_{(k)} = U_{R(k)}$  where  $R(k)$  is the rank of  $U_k$ . Let  $Y_k^* = Y_{R(k)}$ . By Exercise 2.18 the sequence  $Y_k^*$  has the same distribution as the sequence  $Y_k$ . Hence,

$$\begin{aligned} E\left(e^{sQ(t)} | N^P(t) = n\right) &= E\left(e^{s \sum_{k=1}^n \chi\{Y_k > t - T_k^P\}} | N^P(t) = n\right) \\ &= Ee^{s \sum_{k=1}^n \chi\{Y_k^* > t - U_k\}} = \prod_{k=1}^n Ee^{s \chi\{Y_k^* > t - U_k\}} \end{aligned} \quad (4.3)$$

since the service periods are independent of each other and of the arrival times. We can now condition on  $U_k$  to get

$$\begin{aligned} Ee^{s \chi\{Y_k^* > t - U_k\}} &= \int_{u=0}^t Ee^{s \chi\{Y_k^* > t - u\}} \frac{1}{t} du \\ &= \int_{u=0}^t (1 \cdot G(t - u) + e^s(1 - G(t - u))) \frac{1}{t} du \\ &= 1 + (e^s - 1) \int_{u=0}^t (1 - G(t - u)) \frac{1}{t} du. \end{aligned}$$

Using this and (4.3) we have

$$E\left(e^{sQ(t)} | N^P(t) = n\right) = \left[1 + (e^s - 1) \int_{u=0}^t (1 - G(t - u)) \frac{1}{t} du\right]^n.$$

Using this and the fact that  $P(N^P(t) = n) = \exp(-\lambda t)(\lambda t)^n/n!$  we get

$$\begin{aligned} \phi_{Q(t)}(s) &= \sum_{n=0}^{\infty} e^{-\lambda t} \frac{1}{n!} \left[ \lambda t (1 + (e^s - 1) \int_{u=0}^t (1 - G(t - u)) \frac{1}{t} du) \right]^n \\ &= \exp \left\{ \lambda t (e^s - 1) \int_{s=0}^t (1 - G(s)) \frac{1}{t} ds \right\}. \end{aligned}$$

This is the moment generating function of a Poisson random variable. Also as  $t \rightarrow \infty$  we see that the moment generating function of  $Q(t)$  tends to  $\exp(\lambda m_G(e^s - 1))$  since  $\int_0^\infty (1 - G(s)) ds = m_G$  by Exercise 3.4. We conclude that in the long run, the distribution of the number of calls in progress at a fixed time has

a Poisson distribution with mean  $\lambda m_G$ . Calls arrive at a rate of  $\lambda$  per second and each call requires  $m_G$  seconds of work from the network on average hence  $\rho := \lambda m_G$  is the mean amount of work arriving at the switch per second.  $\rho$  is called the load on the system. Hence the mean of the distribution of the number of calls in progress is equal to the load on the system. The telephone engineer can estimate  $\lambda$  based on the number of local subscribers and  $m_G$  is known from past statistical studies. It therefore suffices to put in sufficient trunking capacity  $K$  so that the probability a Poisson variable with mean  $\lambda m_G$  exceeds  $K$  is as small as required.

In fact if  $K$  is the maximum number of calls that can be carried simultaneously then the above model is inadequate. In reality we must study a truncated process  $Q_K(t)$  which is at capacity when  $Q_K(t) = K$ . A call which arrives when  $Q_K(t) = K$  receives a busy signal and is effectively rejected. We will study the distribution of  $Q_K(t)$  later. Also note that we have only considered the distribution of the number of calls in progress at a fixed time  $t$ . In reality we would like a worst case analysis; i.e. the probability that, over some period of time, the number of calls in progress reaches  $K$  thereby causing calls to be dropped.

---

#### Example 4.13 ATM networks - (2.63) continued

Consider an ATM access switch which is connected to thousands of customers. Under ATM, these customers transmit cells asynchronously so conflicts must be resolved by buffering simultaneous arrivals of cells. Different customers transmit cells at different rates so, for instance, a video customer sends cells thousands of times more frequently than a simple phone customer. Assume customer  $i$  sends a cell in a given nanosecond with probability  $p_i = \lambda_i/\eta$  and hence generates a Bernoulli process  $N_i$ . By Theorem 4.11 this process is approximately Poisson with a mean rate of  $\lambda_i/\eta$  cells per nanosecond. Since the sum of independent Poisson processes is a Poisson process, it follows that the total number of cells arriving at the switch from all the customers is approximately Poisson with a mean rate of  $\sum_i \lambda_i/\eta$  cells per nanosecond or  $\sum_i \lambda_i$  cells per second. If we assume the link rate of the switch is one cell per nanosecond, the mean arrival rate per nanosecond had better be less than one or the switch will gradually be overwhelmed with buffered cells!

---

#### Example 4.14 Control charts for attributes - (4.3) continued

One must expect about one error per page during scanning. If the error rate exceeds this an adjustment should be made. One way to control the quality of the scanner is to verify the scan of five pages chosen at random in every book being scanned. This gives a sequence of quality measurements which can be sequentially plotted on a Shewhart quality control chart. If the process is in-control the distribution of the number of errors in any five page segment should be approximately a Poisson random variable with mean 5. One can plot the upper control line on this chart so that if the number of errors in the chosen five pages exceeds this control limit an out-of-control alarm is sounded. The upper control line is fixed so one should

expect a false alarm only once in 10000 measurements or once in 10000 books. The probability a Poisson random variable with mean 5 exceeds 15 is exactly 0.000069 so we should use 15 as the upper control line on the Shewhart chart.

---

#### 4.5 A Further Characterization

In the previous section we have seen that a homogeneous Bernoulli process having rate  $\lambda$  has geometric interarrival times having parameter  $p = \lambda/\eta$ . The  $k^{\text{th}}$  interarrival time  $X_k$  satisfies

$$P(X_k > t) = P(\hat{T}_1 > \hat{t}) = \left(1 - \frac{\lambda}{\eta}\right)^{[\eta t]}$$

which is approximately  $\exp(-\lambda t)$  since  $\eta$  is large. It follows that the interarrival times of the Bernoulli process are approximately exponential with parameter  $\lambda$ . Since the Poisson process  $N^P$  agrees with the Bernoulli process with high probability it follows that the interarrival times of the Poisson process should have a exponential distribution.

Suppose we construct a simple point process by specifying the interarrival times to be independent exponential random variables. Not surprisingly this produces a Poisson process.

**Theorem 4.15** *A simple point process  $M(t)$  having independent, exponential interarrival times must be a Poisson process!*

**Proof:** Note that the time  $T_n^M$  until the  $n^{\text{th}}$  arrival of this process is the sum of  $n$  independent interarrival times each having an exponential distribution. The moment generating function of an exponential random variable with mean  $1/\lambda$  is  $\lambda/(\lambda - t)$  so the moment generating function of the sum is  $\lambda^n/(\lambda - t)^n$ . It follows that the sum has a Gamma distribution with density

$$\frac{\lambda}{(n-1)!} (\lambda x)^{n-1} e^{-\lambda x}$$

which is called is the Erlang- $n$  density. Hence  $T_n^M$  has the Erlang- $n$  distribution. If we take the derivative in  $x$  of  $1 - \sum_{k=0}^{n-1} \exp(-\lambda x)(\lambda x)^k/k!$  we get

$$\begin{aligned} & \lambda \sum_{k=0}^{n-1} \exp(-\lambda x)(\lambda x)^k/k! - \lambda \sum_{k=1}^{n-1} \exp(-\lambda x)(\lambda x)^{(k-1)}/(k-1)! \\ &= \frac{\lambda}{(n-1)!} (\lambda x)^{n-1} e^{-\lambda x}. \end{aligned}$$

It follows that  $P(T_n^M \leq x) = 1 - \sum_{k=0}^{n-1} \exp(-\lambda x)(\lambda x)^k/k!$  which isn't really a

surprise if  $M$  is indeed a Poisson process since then

$$P(T_n^P > x) = P(N^P(x) < n) = \sum_{k=0}^{n-1} \exp(-\lambda x) \frac{(\lambda x)^k}{k!}.$$

Since the  $n^{\text{th}}$  arrival time  $T_n^M$  has the Erlang- $n$  distribution,

$$\begin{aligned} P(M(T) = n) &= P(T_n^M \leq T < T_{n+1}^M) = P(T_n^M \leq T) - P(T_{n+1}^M \leq T) \\ &= \exp(-\lambda T) \frac{\lambda T^n}{n!}. \end{aligned}$$

Hence the number of arrivals in the time interval  $[0, T]$  has a Poisson distribution with parameter  $\lambda T$  just like  $N^P(T)$ . To prove  $M(t)$  really is a Poisson process we must now check that, given there are  $n$  arrivals in  $[0, T]$ , the distribution of these arrival times is that of the order statistics of  $n$  independent uniform random variables on  $[0, T]$ .

For times  $t_1 < t_2 \dots < t_n \leq T$ ,

$$\begin{aligned} &P(T_1^M \leq t_1, T_2^M \leq t_2, \dots, T_n \leq t_n | M(T) = n) \\ &= \frac{P(T_1^M \leq t_1, T_2^M \leq t_2, \dots, T_n \leq t_n, T_{n+1} > T)}{P(M(T) = n)}. \end{aligned} \quad (4.4)$$

Evaluating the numerator of the above we get

$$\begin{aligned} &\int_{x_1 \geq 0} \dots \int_{x_n \geq 0} \int_{x_{n+1} \geq 0} \chi\{x_1 \leq t_1, x_1 + x_2 \leq t_2, \dots, x_1 + \dots + x_n \leq t_n, \\ &\quad x_{n+1} > T - (x_1 + \dots + x_n)\} \cdot \lambda e^{-\lambda x_1} dx_1 \dots e^{-\lambda x_n} dx_n e^{-\lambda x_{n+1}} dx_{n+1} \\ &= e^{-\lambda T} \lambda^n \int_{x_1 \geq 0} \dots \int_{x_n \geq 0} \chi\{x_1 \leq t_1, \dots, x_1 + \dots + x_n \leq t_n\} dx_1 \dots dx_n \end{aligned}$$

after we integrate out  $x_{n+1}$  and use the fact that

$$\int_{x_{n+1} \geq 0} \chi\{x_{n+1} > T - (x_1 + \dots + x_n)\} e^{-\lambda x_{n+1}} dx_{n+1} = e^{-\lambda(T - (x_1 + \dots + x_n))}.$$

Now do a change of variable by letting

$$y_1 = x_1, y_2 = x_1 + x_2, \dots, y_n = x_1 + x_2 + \dots + x_n.$$

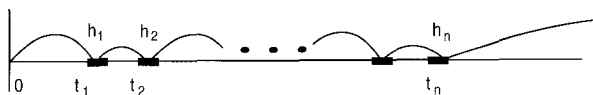

Fig. 4.4 A typical trajectory.

Since the Jacobian of this transformation is 1 the above integral is equal to

$$\begin{aligned}
 & e^{-\lambda T} \lambda^n \int_{0 \leq y_1 \leq T} \int_{y_1 \leq y_2 \leq T} \cdots \\
 & \cdots \int_{y_{n-1} \leq y_n \leq T} \chi\{y_1 \leq t_1, y_2 \leq t_2, \dots, y_n \leq t_n\} dy_1 dy_2 \cdots dy_n \\
 & = e^{-\lambda T} \frac{(\lambda T)^n}{n!} \int_{0 \leq y_1 \leq T} \int_{0 \leq y_2 \leq T} \cdots \\
 & \cdots \int_{0 \leq y_n \leq T} \chi\{y_1 \leq t_1, y_2 \leq t_2, \dots, y_n \leq t_n\} \frac{dy_1}{T} \frac{dy_2}{T} \cdots \frac{dy_n}{T}
 \end{aligned}$$

using symmetry to break up the above integral into  $n!$  possible orderings of  $y_1, \dots, y_n$ . This last integral is precisely,

$$e^{-\lambda T} \frac{(\lambda T)^n}{n!} P(U_{(1)} \leq t_1, U_{(2)} \leq t_2, \dots, U_{(n)} \leq t_n)$$

where  $U_{(1)}, \dots, U_{(n)}$  are the order statistics of  $n$  independent random variables uniformly distributed on  $[0, T]$ . Evaluating (4.4) we now get that

$$\begin{aligned}
 & P(T_1^M \leq t_1, T_2^M \leq t_2, \dots, T_n \leq t_n | M(T) = n) \\
 & = P(U_{(1)} \leq t_1, U_{(2)} \leq t_2, \dots, U_{(n)} \leq t_n)
 \end{aligned}$$

and this is what we wanted to show. ■

#### Example 4.16 Call acceptance - (4.12) continued

We have seen that the number of calls in progress at a telephone switch may be described as a  $M|G|\infty$  queue. The arrivals at an  $M|G|\infty$  queue form a Poisson process and from the above we know that the interarrival times are exponentially distributed. The  $M$  in the acronym  $M|G|\infty$  reminds us that the exponential distribution is memoryless.

---

**Continuation of the proof of Theorem 4.11:** Suppose that  $\{I(t) : 0 \leq t \leq T\}$  is a point process, as in Figure 4.4 having stationary independent Poisson increments such that  $I(0) = 0$ . It follows that  $I(t)$  is a Poisson process! For any increment  $(t, s]$  denote  $\Delta I^{(t,s]} := I(s) - I(t)$ . Clearly  $I(T)$  is Poisson. Let the arrival times

of  $I$  be denoted  $T_1^I, T_2^I, T_3^I, \dots$  so for any disjoint time intervals  $\{(t_k, t_k + h_k] : t_1 < t_2 < \dots < t_n < T\}$ ,

$$\begin{aligned}
 & P(T_k^I \in (t_k, t_k + h_k] : k = 1, 2, \dots, n | I(T) = n) \\
 &= \frac{P(I(t_1) = 0, \Delta I^{(t_1, t_1+h_1]} = 1, \Delta I^{(t_1+h_1, t_2]} = 0, \dots, \Delta I^{(t_n+h_n, T]} = 0)}{P(I(T) = n)} \\
 &= \frac{e^{-\lambda t_1} e^{-\lambda h_1} \lambda h_1 e^{-\lambda(t_2-t_1-h_1)} \dots e^{-\lambda h_n} \lambda h_n e^{-\lambda(T-t_n-h_n)}}{\exp(-\lambda T)(-\lambda T)^n/n!} \\
 &= n! \frac{h_1}{T} \frac{h_2}{T} \dots \frac{h_n}{T}. \tag{4.5}
 \end{aligned}$$

This is precisely the probability that  $n$  i.i.d. uniform random variables on  $[0, T]$  fall into the subintervals  $\{(t_k, t_k + h_k] : t_1 < t_2 < \dots < t_n < T\}$  of  $[0, T]$ . We conclude that given  $I(T) = n$ , the arrival times are the order statistics of i.i.d. uniform random variables on  $[0, T]$ . This completes the characterization of a Poisson process since  $I(T)$  is a Poisson random variable. We conclude  $I$  is a Poisson process on  $[0, T]$ . ■

**Theorem 4.17** *Suppose  $M(t)$  is a simple continuous time point process with stationary, independent increments such that  $M(0) = 0$ . Further suppose*

$$\lim_{h \rightarrow 0} \frac{P(M(h) = 1)}{h} = \lambda \text{ and } P(M(h) > 1) = o(h)$$

where  $\lambda$  is a constant. Then  $M$  is a Poisson process with rate  $\lambda$ .

**Proof:** Represent  $M[s] := \sum_{k=1}^{[s]} (M[k] - M[k-1])$  where each time interval has length  $1/\eta$ . By the above we can now couple  $M[s]$  to a Poisson process  $N^P[s]$  with rate  $\lambda$ . At any time  $t$ , the two processes differ with a probability which tends to 0 as  $\eta \rightarrow \infty$ . Since  $\eta$  is arbitrarily large it follows that  $M(t)$  agrees perfectly with a Poisson process with rate  $\lambda$ . ■

### 4.6 The Poisson Approximation

The term Poisson is derived from the approximation of the binomial distribution by a Poisson distribution. We shall give a more general approximation which will be helpful even for nonhomogeneous Bernoulli processes. To this end we introduce a coupling.

Let  $f$  and  $g$  be two probability mass functions.

**Definition 4.18** The total variation between the p.m.f.s  $f$  and  $g$  is

$$||f - g|| := \sum_x |f(x) - g(x)|.$$

**Proposition 4.19** *If  $X$  and  $Y$  are two random variables defined on the same probability space having probability mass functions  $f$  and  $g$  respectively, then*

$$\|f - g\| \leq 2P(X \neq Y).$$

**Proof:** Using the fact that

$$P(X = z) = P(X = z, Y \neq z) + P(X = z, Y = z)$$

and

$$P(Y = z) = P(X \neq z, Y = z) + P(X = z, Y = z)$$

we have

$$\begin{aligned} \sum_z |P(X = z) - P(Y = z)| &= \sum_z |P(X = z, Y \neq z) - P(X \neq z, Y = z)| \\ &\leq \sum_z P(X = z, Y \neq z) + \sum_z P(X \neq z, Y = z) \\ &= 2P(X \neq Y). \end{aligned}$$

The following proposition shows that  $X$  and  $Y$  may be judiciously coupled together so that the total variation is given by  $2P(X \neq Y)$ . ■

**Proposition 4.20** *There exist two discrete random variables  $X$  and  $Y$  defined on the same probability space  $\{\Omega, \mathcal{F}, P\}$  having marginal probability mass functions  $f$  and  $g$  respectively, such that*

$$\frac{\|f - g\|}{2} = P(X \neq Y).$$

*We say  $X$  and  $Y$  are coupled together.*

**Proof:** Let  $c = \sum_x \min\{f(x), g(x)\}$  and define a probability mass function

$$c(x) = \frac{\min\{f(x), g(x)\}}{c}.$$

$c$  measures the mass  $f$  and  $g$  have in common (if  $c = 0$  let  $c(x) \equiv 0$ ). Moreover define the probability mass function

$$u(x) = \frac{(f(x) - \min\{f(x), g(x)\})}{1 - c}.$$

Similarly define the probability mass function

$$v(x) = \frac{(g(x) - \min\{f(x), g(x)\})}{1 - c}.$$



Note that the support of  $u$  (which is  $\{x : u(x) > 0\}$ ) and the support of  $v$  ( $\{x : v(x) > 0\}$ ) are disjoint. Note, moreover, that  $\min\{a, b\} = (a + b - |a - b|)/2$  for any  $a, b$  so

$$\begin{aligned} c &= \sum_x \left( \frac{f(x) + g(x) - |f(x) - g(x)|}{2} \right) \\ &= 1 - \frac{\sum_x |f(x) - g(x)|}{2} \\ &= 1 - \frac{\|f - g\|}{2}. \end{aligned}$$

Now construct four independent random variables,  $L, U, V$  and  $C$  on the same product probability space  $\{\Omega, \mathcal{F}, P\}$ , such that  $L$  is a Bernoulli random variable with  $P(L = 1) = c$  and  $U, V$  and  $C$  have probability mass functions  $u(x), v(x)$  and  $c(x)$  respectively. Now let us define  $X = L \cdot C + (1 - L) \cdot U$  and  $Y = L \cdot C + (1 - L) \cdot V$ . It is easy to check that  $X$  and  $Y$  have probability mass functions  $f$  and  $g$  respectively. For instance,

$$\begin{aligned} P(X = x) &= P(X = x, L = 0) + P(X = x, L = 1) \\ &= P(U = x, L = 0) + P(C = x, L = 1) \\ &= (1 - c)u(x) + c \cdot c(x) \\ &= f(x) - \min\{f(x), g(x)\} + \min\{f(x), g(x)\} \\ &= f(x). \end{aligned}$$

Moreover

$$P(X \neq Y) = P(L = 0, X \neq Y) = 1 - c = \frac{\|f - g\|}{2}$$

where we used the fact that  $U$  and  $V$  are never equal since their probability mass functions have disjoint support. This follows by simply observing that if  $f(x) < g(x)$  then  $u(x) = 0$  and  $v(x) > 0$  while if  $f(x) > g(x)$  then  $v(x) = 0$  and  $u(x) > 0$ . ■

**Definition 4.21** Let  $Y_k : k = 1, 2, 3, \dots$  be a sequence of independent Poisson random variables such that  $Y_k$  has mean  $p_k$ . For any time  $t$ , let  $N^P(t) := \sum_{k=1}^{\lfloor \eta t \rfloor} Y_k$  be a discrete (nonhomogeneous) Poisson process with intensity  $\langle N^P(t) \rangle := \sum_{k=1}^{\lfloor \eta t \rfloor} p_k$ .

**Theorem 4.22** A (nonhomogeneous) Bernoulli process  $N(t)$  may be coupled to a discrete (nonhomogeneous) Poisson process  $N^P(t)$  such that

$$P(N(s) \neq N^P(s) \text{ for some } s \leq t) \leq \sum_{0 < k \leq \lfloor \eta t \rfloor} p_k^2.$$

**Proof:** Using Proposition 4.20 construct a probability space having an independent sequence of coupled bivariate random variables  $X_k, Y_k$ , for every time interval  $([k - 1], [k]]$ , such that  $X_k$  has the same distribution as  $L_k$ ; that is a Bernoulli random

variable with  $P(L_k = 1) = p_k$  and  $Y_k$  has a Poisson distribution with mean  $p_k$ . Since

$$\left\{ \sum_{0 < k \leq \hat{s}} X_k \neq \sum_{0 < k \leq \hat{s}} Y_k \text{ for some } 0 \leq \hat{s} \leq \hat{t} \right\} \subseteq \cup_{0 < k \leq [\eta t]} \{X_k \neq Y_k\}$$

we have

$$\begin{aligned} P(N(s) \neq N^P(s) \text{ for some } \hat{s} \leq \hat{t}) &\leq P(\cup_{0 < k \leq [\eta t]} \{X_k \neq Y_k\}) \\ &\leq \sum_{0 < k \leq [\eta t]} P(X_k \neq Y_k) \end{aligned}$$

where we have used the subadditivity of the probability measure. By Proposition 4.20

$$\begin{aligned} P(X_k \neq Y_k) &= \frac{\sum |P(X_k = x) - P(Y_k = x)|}{2} \\ &= \frac{1}{2} (|(1 - p_k) - \exp(-p_k)| + |p_k - p_k \exp(-p_k)| \\ &\quad + |1 - \exp(-p_k) - p_k \exp(-p_k)|) \\ &= p_k (1 - \exp(-p_k)) \\ &\leq p_k^2. \end{aligned}$$

In the above we have used the fact that  $\exp(-p_k) - (1 - p_k) \geq 0$  which follows since

$$\begin{aligned} p^2/2! - p^3/3! + p^4/4! - p^5/5! + \dots \\ \geq p^2/2! - p^3/2! + p^4/4! - p^5/4! + \dots \\ = (1 - p)(p^2/2! + p^4/4! + \dots) \geq 0. \end{aligned}$$

The result follows. ■

Notice that Theorem 4.22 is a statement about distributions. We start with a Bernoulli process  $N[s]$  but we actually construct another Bernoulli process  $\sum_{k=1}^{[s]} X_k$  having the same distribution as  $N[s]$ . A discrete Poisson process  $N^P[s]$  is constructed to be close to this new Bernoulli process in a pathwise sense; that is as random variables. It follows that  $\{\sum_{k=1}^{[s]} X_k; 0 \leq [s] \leq T\}$  and  $\{N^P[s]; 0 \leq [s] \leq T\}$  are also close in a distributional sense. Consequently  $\{N[s]; 0 \leq [s] \leq T\}$  is close to  $\{N^P[s]; 0 \leq [s] \leq T\}$  in a distributional sense but *not* as sequences of random variables. The statement of Theorem 4.22 is therefore a bit sloppy because we have confounded  $N$  and its copy.

Suppose we had a discrete point process  $M[s]$  which might allow multiple arrivals in one nanosecond. Suppose nevertheless that the nanosecond increments are independent. The above Poisson coupling would still be valid if  $P(M[k] - M[k-1] = 1) = p_k$  and  $P(M[k] - M[k-1] > 2) = o(p_k)$  where  $o(x)/x \rightarrow 0$  as  $x \rightarrow 0$ . It suffices to define  $X_k = M[k] - M[k-1]$  while  $Y_k$  is as above. Let the p.m.f. of  $X_k$

be  $f_k$  and let the Poisson p.m.f. of  $Y_k$  be  $g$ . Remark that

$$\begin{aligned} & \sum_x |f(x) - g(x)| \\ & \leq (e^{-p_k} - (1 - p_k - \mathbf{o}(p_k))) + (p_k - p_k e^{-p_k}) + (\mathbf{o}(p_k) + 1 - p_k - e^{-p_k}) \\ & = p_k(1 - e^{-p_k}) + \mathbf{o}(p_k) \leq p_k^2 + \mathbf{o}(p_k). \end{aligned}$$

We can now couple  $N^P[s] := \sum_{k=1}^{[s]} Y_k$  to  $M[s]$  by making copies of  $N^P$  and  $M$  which are close:

$$P(M[s] \neq N^P[s] \text{ for some } [s] \leq [\eta t]) \leq \sum_{0 < k \leq [\eta t]} (p_k^2 + \mathbf{o}(p_k)).$$

If the process  $M$  is homogeneous the above estimate is equal to

$$\lambda^2 t / \eta + \lambda \mathbf{o}(\lambda / \eta) / (\lambda / \eta) \rightarrow 0 \text{ as } \eta \rightarrow \infty.$$

**Theorem 4.23** *If  $N(t)$  is a (nonhomogeneous) Bernoulli process then*

$$\sum_{x=0}^{\infty} |P(N(t) = x) - \exp(-\langle N(t) \rangle) \frac{\langle N(t) \rangle^x}{x!}| \leq 2 \sum_{0 < k \leq [\eta t]} p_k^2.$$

**Proof:** Recall that a sum of independent Poisson variables is Poisson (see Example 3.23). Hence  $N^P(t)$  is Poisson with mean  $\langle N(t) \rangle$  and

$$\begin{aligned} & \sum_{x=0}^{\infty} |P(N(t) = x) - \exp(-\langle N(t) \rangle) \frac{\langle N(t) \rangle^x}{x!}| \\ & = \sum_{x=0}^{\infty} |P(\sum_{0 < k \leq [\eta t]} X_k = x) - P(\sum_{0 < k \leq [\eta t]} Y_k = x)| \\ & \leq 2P(\sum_{0 < k \leq [\eta t]} X_k \neq \sum_{0 < k \leq [\eta t]} Y_k) \text{ by Proposition 4.19} \\ & \leq 2 \sum_{0 < k \leq [\eta t]} p_k^2 \text{ by Theorem 4.22.} \end{aligned}$$

The result follows. ■

**Proof of Theorem 4.11:** We can represent  $N^P$  as the sum of its nanosecond increments; that is

$$N^P[s] = \sum_{k=1}^{[s]} (N^P[k] - N^P[k-1]) = \sum_{k=1}^{[s]} Y_k$$

where  $Y_k, k = 1, \dots$  is a sequence of independent Poisson random variables with mean  $p = \lambda / \eta$ . Using Theorem 4.22 we may construct sequences  $\{(L_k, Y_k)\}_{k=1}^{[\eta t]}$

such that the Bernoulli process  $N[s] := \sum_{k=1}^{[s]} L_k$  and the discrete Poisson process  $N[s] := \sum_{k=1}^{[s]} Y_k$  are closely coupled together. In fact

$$P(N(s) \neq N^P(s) \text{ for some } s \leq t) \leq \sum_{0 < k \leq [t\eta]} \left(\frac{\lambda}{\eta}\right)^2 = \frac{\lambda^2 t}{\eta}.$$

**Corollary 4.24** *If  $N(t)$  is a homogeneous Bernoulli process with rate  $\lambda$  then*

$$\sum_{x=0}^{\infty} |P(N(t) = x) - \exp(-\lambda t) \frac{(\lambda t)^x}{x!}| \leq \frac{2\lambda^2 t}{\eta}.$$

**Proof:** The result follows immediately from Proposition 4.23 since

$$\langle N(t) \rangle = \eta t \lambda / \eta = \lambda t \text{ and } \sum_{0 < k \leq [t\eta]} \left(\frac{\lambda}{\eta}\right)^2 = \frac{\lambda^2 t}{\eta}.$$

We conclude that the probability mass function of the Bernoulli process is approximately Poisson and the order of the error is  $1/\eta$ ; that is, extremely small. ■

**Corollary 4.25** *If  $N(t)$  is a homogeneous Bernoulli process with rate  $\lambda$  and if  $T_m$  is the time of the  $m^{\text{th}}$  arrival measured in seconds, then*

$$|P(T_m \leq t) - \left(1 - \sum_{x=0}^{m-1} \exp(-\lambda t) \frac{(\lambda t)^x}{x!}\right)| \leq \frac{2\lambda^2 t}{\eta}.$$

**Proof:** Since  $\{T_m \leq t\} = \{N(t) \geq m\}$  the result follows easily from Corollary 4.24. ■

Recall that the continuous distribution  $1 - \sum_{x=0}^{m-1} \exp(-\lambda t) (\lambda t)^x / x!$  is called the Erlang- $m$  distribution.

**Example 4.26** Let  $N(t)$  represent a Bernoulli process and let  $N^P$  represent the approximating Poisson process. Suppose the arrival of an event at time  $t$  from the Poisson process implies a cost  $C$ . Assume that there is a constant interest rate  $\alpha$  so that the present value of  $C$  dollars spent at time  $t$  is only  $C \exp(-\alpha t)$  at time 0. The present value of future costs up to time  $T$  is represented by an integral.

$$\int_0^T C \exp(-\alpha t) dN^P(t) \approx \int_0^T C \exp(-\alpha t) dN(t) = \sum_{k=1}^{[T\eta]} C \exp(-\alpha k/\eta) L_k$$

where in every time interval  $([k-1], [k]]$ , we perform an independent Bernoulli trial  $L_k$  to decide the presence (with probability  $\lambda/\eta$ ) or absence (with probability

$1 - \lambda/\eta$ ) of an arrival by the end of that unit of time. The expected future cost is then

$$E \left[ \int_0^T C \exp(-\alpha t) dN^P(t) \right] \approx \sum_{k=1}^{\lfloor \eta T \rfloor} C \exp(-\alpha k/\eta) \frac{\lambda}{\eta} \approx \int_0^T C \exp(-\alpha t) \lambda dt.$$

We conclude the future expected cost to time  $T$  for the stream of Poisson arrivals is  $\int_0^T C \exp(-\alpha t) \lambda dt$ . Similarly, using the independence of the Bernoulli trials, the variance of the future cost for the Bernoulli process is

$$\sum_{k=1}^{\lfloor \eta T \rfloor} C^2 \exp(-2\alpha k/\eta) \frac{\lambda(1-\lambda)}{\eta} \approx \int_0^T C^2 \exp(-2\alpha t) \lambda dt.$$

Again, passing to the limit, we conclude

$$\text{Var} \left[ \int_0^T C \exp(-\alpha t) dN^P(t) \right] = \int_0^T C^2 \exp(-2\alpha t) \lambda dt.$$

The above is a typical stochastic integral with respect to a point process. The calculation may also be generalized to stochastic integrands. Suppose for instance that arrivals wait at a  $M/M/\infty$  queue of size  $Q(t)$ , at time  $t$ , and the cost of an arrival at time  $t$  is given by  $cQ(t^-)$ ; that is  $c$  dollars times the number of customers already waiting. The future cost to time  $T$  associated with arrivals of the Poisson process  $N^P$  is

$$\int_0^T cQ(t^-) \exp(-\alpha t) dN^P(t) \approx \sum_{k=1}^{\lfloor \eta T \rfloor} Q((k-1)/\eta) \exp(-\alpha k/\eta) L_k.$$

Again using independence the expected future cost is

$$\begin{aligned} E \left[ \int_0^T cQ(t^-) \exp(-\alpha t) dN^P(t) \right] &\approx \sum_{k=1}^{\lfloor \eta T \rfloor} EQ((k-1)/\eta) \exp(-\alpha k/\eta) \frac{\lambda}{\eta} \\ &\rightarrow \int_0^T cEQ(t^-) \exp(-\alpha t) \lambda dt. \end{aligned}$$

The expected number of customers in an  $M/M/\infty$  queue may be calculated using Example 4.12.

### 4.7 Nonhomogeneous Poisson Processes

Let  $\lambda(t)$  be a nonnegative, piecewise continuous function on  $[0, T]$  and let

$$\Lambda(t) = \int_{s=0}^t \lambda(s) ds < \infty.$$

**Definition 4.27** For a Poisson process  $N^P$  having arrival rate 1, define

$$N^\Lambda(t) = N(\Lambda(t))$$

to be a nonhomogeneous Poisson process with intensity function  $\lambda(t)$ .

Suppose some individual has a faulty watch which records  $t$  seconds when in fact  $\Lambda(t)$  seconds have passed, as in Figure 4.5. Suppose now he watches a homogeneous Poisson process having rate 1 for  $t$  seconds of time according to his watch. In fact  $\Lambda(t)$  seconds will have passed and so he will have seen  $N(\Lambda(t))$  arrivals. Hence the process  $N^\Lambda(t)$  is simply a homogeneous Poisson process as seen by someone with a defective watch. We may derive the properties of this process.

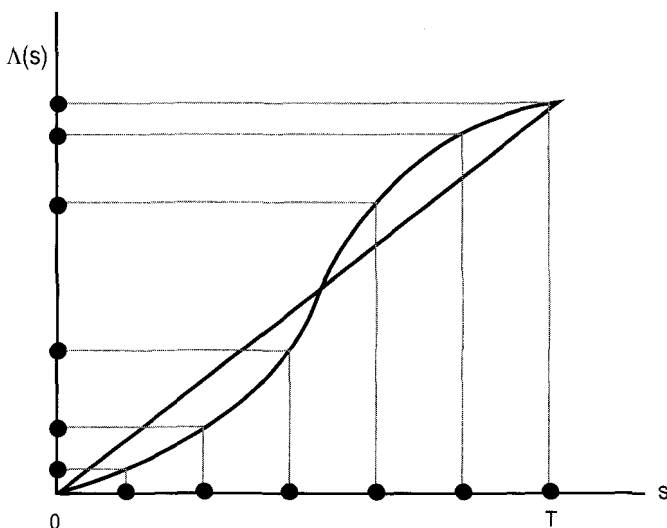

Fig. 4.5 Time measured with a broken watch.

**Proposition 4.28** For a nonhomogeneous Poisson process

- $N^\Lambda(0) = 0$ .
- $N^\Lambda(t)$  has independent increments.
- $P(N^\Lambda(s+t) - N^\Lambda(s) = i) = e^{-(\Lambda(s+t) - \Lambda(s))} \frac{(\Lambda(s+t) - \Lambda(s))^i}{i!}$ .

**Proof:** These properties follow immediately from those of homogeneous Poisson processes. We shall do one calculation.

$$\begin{aligned} P(N^\Lambda(t) = i) &= P(N(\Lambda(t)) = i) \\ &= \exp(-\Lambda(t)) \frac{(\Lambda(t))^i}{i!}. \end{aligned}$$

■

The nonhomogeneous Poisson process is a more realistic description of an arrival process particularly over a long period of time. If, for instance, one wished to describe the arrival stream of visitors to a bank it is clear the intensity of arrivals is higher around noon than at two p.m.

**Proposition 4.29** *Conditioned on the event  $\{N^\Lambda(t) = n\}$ , the distribution of the arrival times  $\{T_k^\Lambda : k = 1, \dots, n\}$  is that of the order statistics of  $n$  i.i.d. random variables on  $[0, t]$ , having distribution  $F(s) = \Lambda(s)/\Lambda(t)$  for  $0 \leq s \leq t$ .*

**Proof:** Since the nonhomogeneous Poisson process is simply a homogeneous Poisson process looked at with a broken watch, we know the conditional arrival times are really the order statistics of  $n$  independent variables  $\{U_k : k = 1, \dots, n\}$  uniformly distributed on  $[0, \Lambda(t)]$ . When viewed with the broken watch, these times are still independent but are transformed to  $Y_k = \Lambda^{-1}(U_k) : k = 1, \dots, n$ . For any  $0 \leq s \leq t$  the distribution of the times  $Y_k$  is given by

$$\begin{aligned} P(Y_k \leq s) &= P(\Lambda^{-1}(U_k) \leq s) \\ &= P(U_k \leq \Lambda(s)) \\ &= \Lambda(s)/\Lambda(t). \end{aligned}$$

Hence the arrivals of  $N^\Lambda$  are simply the times  $Y_k$  arranged in increasing order and the result follows. ■

Consider a nonhomogeneous Poisson process rounded up to the next nanosecond. Only count one arrival if two or more arrivals are rounded up to the same nanosecond. The resulting process is a nonhomogeneous Bernoulli process. This follows by the memorylessness property of the Poisson process as before. In fact the probability there is no arrival in the  $t^{\text{th}}$  nanosecond is  $1 - p = \exp(-(\Lambda(t) - \Lambda(t - 1/\eta)))$  which to first order is  $\exp(-\lambda(t)/\eta)$ . Consequently, to first order, the probability  $p$  of an arrival is  $\lambda(t)/\eta$ . Hence, to first order, this is the kind of nonhomogeneous Bernoulli process discussed in Section 1 of this chapter. We see, moreover, the approximation Theorem 4.23 is simply a precise statement of the approximation of a nonhomogeneous Bernoulli process by a nonhomogeneous Poisson process.

Proposition 4.29 provides some insight into the problem of testing if a point process is a nonhomogeneous Poisson process. Suppose we have  $q$  independent replications  $\{N_i, i = 1, \dots, q\}$  of the point process on  $[0, T]$ , as in Figure 4.6. First we must test if the variables  $\{N_i(T), i = 1, \dots, q\}$  are i.i.d. Poisson random variables. A chi-squared test might be easiest. Next, as we have seen, the nonhomogeneous Poisson process is simply a homogeneous Poisson process observed by someone with a broken watch. Hence this class of processes is invariant under monotonic transformations of the time axis (since this amounts to swapping broken watches). Consequently the exact arrival times of these replications provide no information about the Poisson nature of the process. However the relative rankings of the points do since the ranking of the arrival times among themselves is invariant under monotonic transformations. We conclude from Proposition 4.29 that we should test

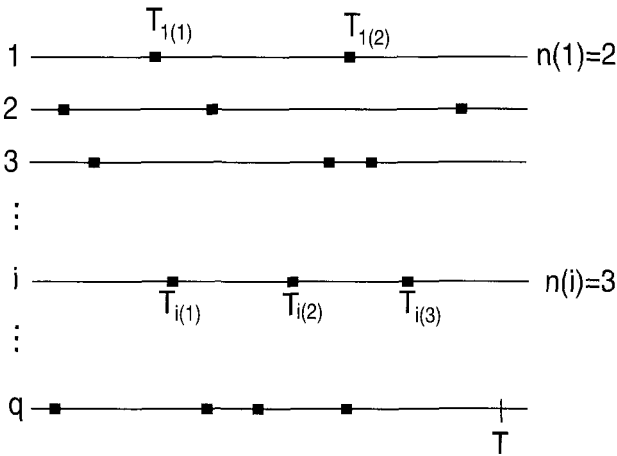

Fig. 4.6 Only the relative ranks of arrival times are invariant.

if the arrival times of all the replications are identically distributed but the above argument shows this test should be based only on the ranks of the arrival times. Such nonparametric tests exist and the Cramer-Von Mises  $q$ -sample statistics are a good choice. Competing models are often also invariant under monotonic transformations of the time axis. A cluster process in which arrival times tend to cluster together will still have this property when regarded with a broken watch. Such models will consequently be easily distinguished by the Cramer-Von Mises  $q$ -sample statistics (see Chouinard and McDonald (1985)).

Proposition 4.29 is useful for simulating nonhomogeneous Bernoulli processes. It is clearly impossible to simulate the  $\eta t$  independent Bernoulli random variables, each having probability of success  $p_i = \lambda(t)/\eta$ , which make up  $N(s) : 0 \leq s \leq t$ . Instead we generate a Poisson random variable  $N^\Lambda(t)$  and then if  $N^\Lambda(t) = n$ , generate  $n$  independent random variables having distribution  $F(s) = \Lambda(s)/\Lambda(t)$  for  $0 \leq s \leq t$ . By Proposition 4.29 the points generated, viewed in increasing order, give a point process  $T_n^\Lambda$  which is Poisson. The corresponding Bernoulli process is then obtained by rounding these arrival times up to the next nanosecond and ignoring multiple arrivals in the same nanosecond. This Bernoulli process is, to first order, the one desired.



## 4.8 Exercises

**Exercise 4.1** Let  $N(t)$  be a Bernoulli point process with the probability of an arrival in any nanosecond being  $p = \lambda/\eta$ . Let  $L_k$  be 1 if there is an arrival between nanoseconds  $[k - 1]$  and  $[k]$  and 0 otherwise. Suppose we observe

$$L_{-3} = 0, L_{-2} = 1, L_{-1} = 0, L_0 = 0, L_1 = 1, L_2 = 0, L_3 = 1.$$

- Give the values of  $N[\hat{t}], Z[\hat{t}], Y[\hat{t}]$  for  $\hat{t} \in \{-3, -2, -1, 0, 1, 2, 3\}$ .
- Give the values of  $T_n, X_n$  for  $n \in \{0, 1, 2\}$ .

**Exercise 4.2** Let  $\{N_i(t) : i = 1, \dots, d\}$  be independent Bernoulli processes where  $N_i$  has mean arrival rate  $\lambda_i$ .

Calculate the probability that  $N_1$  has the first arrival of all.

**Exercise 4.3** If  $\{W_1, W_2, \dots, W_n\}$  are i.i.d. with common density  $f_W$ , give the density of the  $k^{\text{th}}$  order statistic  $W_{(k)}$ .

**Exercise 4.4** Prove (4.1).

**Exercise 4.5** If  $N^P$  is a Poisson process with rate  $\lambda$  calculate  $E[N^P(t) \cdot N^P(t+u)]$ .

**Exercise 4.6** Model the number of calls to a telephone exchange by a Poisson process having an intensity of 100 calls per hour.

- In the first ten minutes what is the probability of 2 or more calls?
- What is the probability there were exactly 2 calls in the first ten minutes and exactly 4 calls in the first twenty minutes?
- Calculate the distribution of the time until two calls arrive.

**Exercise 4.7** Suppose the stream of customers arriving in a store may be described by a Poisson process with a rate of 15 customers per hour.

- Calculate the probability that there are less than 2 customers in the first 20 minutes of the day, but more than 3 customers in the first 30 minutes.
- Given there were less than 2 customers in the first 20 minutes, what is the expected number of customers within the first hour?

**Exercise 4.8** A resistor in an integrated circuit for a compact disk player has a resistance which may be represented by  $10 + R$  micro-ohms, where  $R$  is the random exponential error in building the resistor (resistors having resistances of less than 10 micro-ohms are discarded). Assume the mean error is 0.1 micro-ohms. Unfortunately this error will introduce random digital errors in the sound track (resulting in a tiny clicking sound) which occur according to a Poisson process at rate  $0.002 \times R$  per second.

- Calculate the distribution of a Poisson variable with parameter  $\lambda$ , which itself is random with exponential distribution of mean  $1/c$ .
- What is the probability one hour of play will be recorded without error?

Exercise 4.9 Suppose blocks of customers arrive according to a Poisson stream of rate  $\lambda$ . The number of customers in a block is random and the probability of  $k$  customers is  $f(k)$ . Customers join a queue with a single server and general service distribution  $G$ . Let  $M(t)$  denote the number of customers that have arrived by time  $t$ .

- What is  $E[M(t)]$ ?
- Is  $M(t)$  Poisson distributed?

Exercise 4.10 Suppose that cars enter a one-way toll highway at mile 0 at a Poisson rate  $\lambda$ . Each car independently chooses a speed according to a common distribution  $G$ . Assuming cars of higher speeds can pass (without changing speed) derive the distribution of the number of cars in the interval between mile  $A$  and mile  $B$  at time  $t$ . Derive the steady state distribution by letting  $t \rightarrow \infty$ .

Exercise 4.11 Let  $E_1, E_2, \dots, E_n$  be independent, exponential random variables with means  $1/\lambda_1, 1/\lambda_2, \dots, 1/\lambda_n$ . Show that

$$P(E_j = \min\{E_i; i = 1, 2, \dots, n\}, E_j > t) = \frac{\lambda_j}{\sum_{i=1}^n \lambda_i} \exp(-t \sum_{i=1}^n \lambda_i).$$

Exercise 4.12 Let  $N_1(t), N_2(t), \dots, N_n(t)$  denote  $n$  independent Poisson streams with rates  $\lambda_1, \lambda_2, \dots, \lambda_n$ . Show that  $N_1(t) + N_2(t) + \dots + N_n(t)$  is a Poisson stream with rate  $\sum_{i=1}^n \lambda_i$ . Using Exercise 4.11 show that the probability the first event of the combined process comes from  $N_1(t)$  is  $\lambda_1 / \sum_{i=1}^n \lambda_i$  independent of the time of the event.

Exercise 4.13 Suppose calls arrive at the 911 emergency desk at a mean rate of 10 per hour day or night.

- Explain why it is appropriate to describe the process of call arrivals as a Bernoulli process that can be approximated by a Poisson process. When would this description be inappropriate?
- What is the probability 12 calls arrive between 1am and 2am.
- What is the probability 12 calls arrive between 1am and 2am and 16 calls arrive between 1am and 3am.
- Given that 12 calls arrived between 1am and 2am, what is the probability that no calls arrived between 1am and 1:15am.
- Each emergency call ties up one operator. The duration of calls is well described by a Weibull distribution with a mean of 6.2 minutes. At precisely 1am, what is the probability that 3 operators are busy?
- How many operators should be on duty to ensure that all calls ongoing at 1am are handled immediately with a probability exceeding 99%.
- Actually we want to be 99% sure that all calls in a 24 hour period are handled immediately. Should the number of operators on duty be the same as in f)?

Exercise 4.14 a) Model the number of calls to a telephone exchange by a Poisson process having an intensity of 100 calls per hour. Suppose that every 10<sup>th</sup> call is

analyzed for statistical purposes. How many calls should we expect to analyze in an 8-hour period?

b) What is the distribution of the time interval between calls which must be analyzed?

c) Is the stream of calls that must be analyzed a Poisson process?

Exercise 4.15 For a Poisson process  $N^P$ , show that for  $u < t$

$$P(N^P(u) = k | N^P(t) = n) = \binom{n}{k} \left(\frac{u}{t}\right)^k \left(1 - \frac{u}{t}\right)^{n-k}, \quad k = 0, 1, \dots, n.$$

Exercise 4.16 Let  $S_1, S_2, \dots$  denote the successive interarrival times of a nonhomogeneous Poisson process having intensity  $\lambda(t)$ .

a) Are the  $S_i$  independent?

b) Are the  $S_i$  identically distributed?

c) Find the distribution of  $S_1$ .

d) Find the distribution of  $S_2$ .

Exercise 4.17 a) Customers arrive at the museum according to an unknown point process. For security purposes the time of arrival of each visitor is recorded at the front desk as is the time of departure of a visitor. No names are taken of course so it is not possible to connect the departure time with the corresponding arrival time. The museum director wants to have some statistics on the distribution of time spent by each visitor to the museum. Show that the average departure time minus the average arrival time is a good estimate of the mean viewing time.

b) Now suppose visitors arrive at the museum according to a nonhomogeneous Poisson process with intensity  $\lambda(t)$  and suppose that the distribution of the viewing time is  $F$ . If there  $n$  arrivals in total (on days with intensity  $\lambda$ ) then the distribution of these arrivals is the order statistics of  $n$  i.i.d. random variables  $T_k$  having density  $\lambda(t)/\Lambda(T)$  where  $\Lambda(T)$  is the cumulative intensity of one day. In addition we measure the associated departure times  $S_k = T_k + V_k$  where  $V_k$  is the associated viewing time.

Of course we don't really know the value of  $S_k$  that corresponds to  $T_k$ . Nevertheless we can estimate  $\phi_T(s)$ , the generating function of the  $T_k$ 's, and  $\phi_S(s)$ , the generating function of the  $S_k$ 's, by

$$\hat{\phi}(s) = \sum_{k=1}^n \exp(sT_k)/n \quad \text{and} \quad \hat{\phi}(s) = \sum_{k=1}^n \exp(sS_k)/n.$$

Since  $\phi_S(s) = \phi_T(s) \cdot \phi_V(s)$  we can therefore estimate  $\phi_V(s)$ , the generating function of the viewing times. Show how to estimate the variance of  $F$ .

Exercise 4.18 Suppose that failures occur at a Poisson rate  $\lambda = 2$  per week. If the number of defective items generated by each failure is independent and takes on the values 1, 2, 3, 4 with respective probabilities  $\frac{1}{6}, \frac{1}{3}, \frac{1}{3}, \frac{1}{6}$ , then what is the expected

value and variance of the number of defective items produced during a fixed five week period?

**Exercise 4.19** A store opens at 8 in the morning. From 8 until 10, customers arrive at a Poisson rate of six an hour. Between 10 and 12 they arrive at a Poisson rate of ten an hour. From 12 to 2, the store closes for lunch. Finally, from 2 to 5, the arrival rate drops linearly from ten per hour at 2 to four per hour at 5. Determine the probability distribution of the number of customers that enter the store on a given day.

**Exercise 4.20** Telephone calls arrive at the call center at a rate of 10 calls per second. The duration of calls seems to follow a Weibull distribution with a mean of 2.3 minutes and a standard deviation of .6 minutes.

- a) Calculate the probability 5 calls arrive in the first ten seconds after 1 pm but 30 calls arrive in the first 20 seconds after 1pm. (Just write down an expression - don't evaluate it).
- b) What is the probability there are more than 1500 calls in progress at 1pm. (Just write down an expression - don't evaluate it).
- c) If we look at the point process of departures when calls end do we see a Poisson process?

**Exercise 4.21** Simulate the arrival process at the store described in Exercise 4.19. Make a histogram of the daily customer arrivals for 500 days and compare this with the theoretical distribution derived in Exercise 4.19.

## Chapter 5

# Markov Chains

### 5.1 Introduction

Consider a stochastic process  $\{X_n; n = 0, 1, \dots\}$  defined on a probability space  $\{\Omega, \mathcal{F}, P\}$ , taking values in a countable set or state space  $S$ , which we will assume to be a subset of the nonnegative integers  $\{0, 1, \dots\}$  unless explicitly defined otherwise. If  $X_n \equiv X_n(\omega) = i$  we say the process is in state  $i$  at time  $n$ .

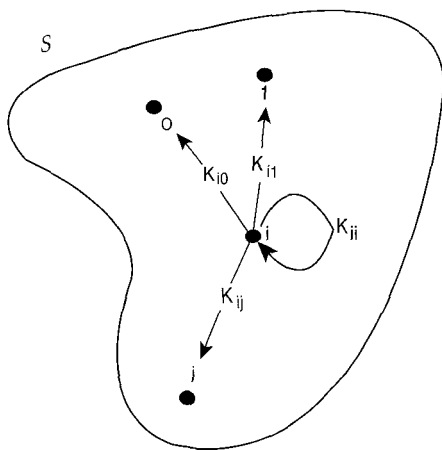

Fig. 5.1 Transitions from state  $i$  to state  $j$  have probability  $K_{ij}$ .

**Definition 5.1** We say the process  $X_n$  is a homogeneous Markov chain defined on  $\{\Omega, \mathcal{F}, P\}$ , if for all  $n \geq 0$  and for any state  $j$  and any sequence of preceding states  $\{i_0, i_1, \dots, i_{n-1}, i\}$ , we have

$$P(X_{n+1} = j | X_n = i, X_{n-1} = i_{n-1}, \dots, X_0 = i_0) = K_{ij}.$$

$K$  is called the probability transition kernel of the Markov chain. We say the initial distribution is  $\alpha$  if  $P(X_0 = i) = \alpha(i)$  and we sometimes denote  $P$  by  $P_\alpha$ . If  $\alpha(i_0) = 1$  then denote  $P$  by  $P_{i_0}$ . Similarly, if the initial distribution is  $\alpha$  or if  $\alpha(i_0) = 1$  we denote the associated expectations by  $E_\alpha$  or  $E_{i_0}$  respectively.

Intuitively the above conditions mean that knowing the chain is in state  $i$  at time  $n$  summarizes the entire past up to time  $n$ ; that is the conditional probability the chain jumps next to state  $j$ , given the chain is in state  $i$  at time  $n$ , does not depend on  $X_{n-1}, \dots, X_0$ . Moreover, the distribution of this jump is time independent as it does not depend on  $n$ . Indeed this conditional probability is given by the probability transition kernel  $K_{ij}$ . Clearly the kernel  $K$  is represented by a nonnegative matrix

$$\begin{pmatrix} K_{00} & K_{01} & K_{02} & \cdots & K_{0j} & \cdots \\ K_{10} & K_{11} & K_{12} & \cdots & K_{1j} & \cdots \\ K_{20} & K_{21} & K_{22} & \cdots & K_{2j} & \cdots \\ \vdots & \vdots & \vdots & \vdots & \vdots & \vdots \\ K_{i0} & K_{i1} & K_{i2} & \cdots & K_{ij} & \cdots \\ \vdots & \vdots & \vdots & \vdots & \vdots & \vdots \end{pmatrix}.$$

A homogeneous Markov chain satisfies the Markov property

$$P(X_{n+1} = j | X_n = i, \dots, X_0 = i_0) = P(X_{n+1} = j | X_n = i) = K_{ij}.$$

Conditioning on the past, up to jump  $n$ ,

$$\begin{aligned} P(X_{n+1} = j, X_n = i, X_{n-1} = i_{n-1}, \dots, X_0 = i_0) \\ = K_{ij} P(X_n = i, X_{n-1} = i_{n-1}, \dots, X_0 = i_0) \end{aligned}$$

so summing over all possible values of  $i_0, i_1, \dots, i_{n-1}$  we have

$$P(X_{n+1} = j, X_n = i) = K_{ij} P(X_n = i);$$

that is,

$$P(X_{n+1} = j | X_n = i) = K_{ij}.$$

Since this doesn't depend on  $n$  we conclude

$$\begin{aligned} P(X_{n+1} = j | X_n = i, X_{n-1} = i_{n-1}, \dots, X_0 = i_0) \\ = P(X_{n+1} = j | X_n = i) \\ = K_{ij} = P(X_1 = j | X_0 = i). \end{aligned}$$

### Example 5.2 Bursty ATM traffic

Until now we have considered sources where cells arrive independently with probability  $p$  during each time interval. This is somewhat naive. Typically, a source  $i$

alternates between silent periods, when no cells are emitted, and bursts, when cells are generated at regularly spaced time intervals at a peak rate of  $R_i$  cells per second. If the output rate is  $L$  cells per second we may define a time slot of  $1/L$  seconds. Hence a burst on source  $i$  may be viewed as a sequence of cells arriving every  $L/R_i$  time slots. If  $\sum_{i=1}^N R_i \leq L$  it is clear that  $N$  sources may be multiplexed together provided a buffer can temporarily queue cells that arrive in the same time slot. A small delay results which is called a jitter and the maximum cell delay variation should not be large.

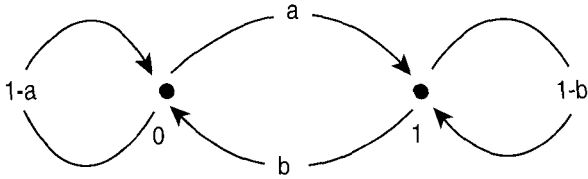

Fig. 5.2 A chain representing idle and peak transmission.

A bursty traffic source  $i$  such as digitized voice transmissions may in general be described as an  $n$ -state Markov chain. Such sources are called Markov modulated sources. A two state model has an idle state 0 and a burst state 1 as in Figure 5.2. In the idle state no cells are transmitted while in the burst state, cells are transmitted with peak rate  $P$ . Every time slot a transition is made between these two states according to the following transition kernel:

$$K = \begin{pmatrix} 1 - a & a \\ b & 1 - b \end{pmatrix}.$$

Given the chain starts in the idle state, the probability it jumps to the burst state in the  $n^{th}$  time slot is

$$K_{00}K_{00} \cdots K_{00}K_{01} = (1 - a)^{n-1}a.$$

Consequently, the sojourn in the idle state is a geometric random variable with mean  $A = 1/a$  time slots. Similarly, the sojourn in the burst state is a geometric random variable with mean  $B = 1/b$  time slots.

ATM takes advantage of the idle periods of bursty sources since it may be that the sum of the peak source rates  $R_i$  of  $N$  sources exceeds the link rate  $L$ . This is called statistical multiplexing and it provides a substantial improvement in carrying capacity. On the other hand, when the output link capacity is exceeded the buffer at the link will quickly overflow and cells will be lost. The task of the traffic engineer is to manage the link to ensure these losses occur with very low probability.

**Example 5.3 ATM multiplexor - - (3.2) continued**

Consider the ATM multiplexor which multiplexes 5 trunk lines carrying noisy ATM traffic. As before we assume that in each time slot a trunk line presents a cell to the multiplexor with probability  $1/10$ . During the time slot the head of the line cell in the queue is transmitted to the output link while arriving cells are added to the queue.  $Q_{[t]}$  represents the number of cells waiting in the queue at the end of each time slot. We assume a cell arriving at an empty queue is queued for one time slot.  $Q_{[t]}$  is a Markov chain on the state space  $S = \{0, 1, 2, \dots\}$ . In Figure 5.3, the queue initially contains two cells.

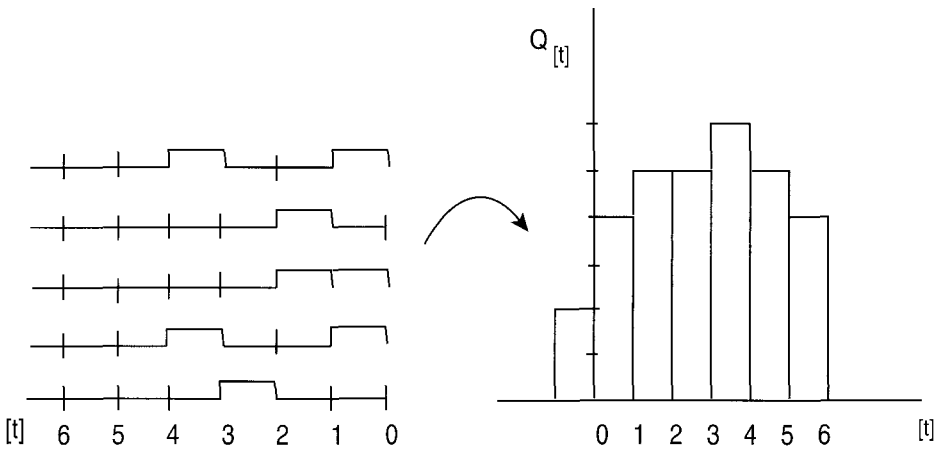

Fig. 5.3 A typical arrival stream driving an (infinite) ATM queue.

Clearly the number of cells that may arrive at time  $[t]$  is a Binomial random variable  $B_{[t]}$  with  $n = 5$  and  $p = 1/10$ . Let  $b(k; 5, 0.1) := P(B_{[t]} = k)$ . The transition kernel is given by

$$K_{ij} = \begin{cases} b(j; 5, 0.1) & \text{if } i = 0 \\ b(j - i + 1; 5, 0.1) & \text{if } i > 0, -1 \leq j - i \leq 4 \\ 0 & \text{otherwise.} \end{cases}$$

Now assume the multiplexor buffer holds only 6 cells because a delay longer than 6 time slots is unacceptable. If more cells arrive than can be stored then these cells are lost! Note that the transfer of the head of the line cell to the output link is complete at the end of the time slot so that buffer was unavailable for arrivals. Consequently there are never more than 5 cells in the queue at the end of a time slot.

In Figure 5.3 an overload occurs during the 4<sup>th</sup> time unit so in fact one cell is lost. Let  $Q_{[t]}^B$  represents the number of cells waiting in this finite buffer queue at the end of each time slot. The state space for  $Q_{[t]}^B$  is  $\{0, 1, 2, 3, 4, 5\}$  and the transition



kernel is given by

$$K_{ij}^B = \begin{cases} b(j; 5, 0.1) & \text{if } i = 0 \\ b(j - i + 1; 5, 0.1) & \text{if } i > 0, -1 \leq j - i \leq 4, j < 5 \\ \sum_{k=6-i}^5 b(k; .5, 0.1) & \text{if } i > 0, j = 5. \end{cases}$$

The matrix  $K^B$  defined above may be calculated using *Mathematica* as below.

```
L=6      (*We assume the buffer only holds 5 cells*)
M=5      (*There are 5 input trunk lines*)
p=1/10  (*Each line delivers a cell with probability p*)
bin[x_] :=bin[x]=Binomial[M,x] p^x (1-p)^(M-x)
f[x_] :=bin[x+1]      (*f is the p.m.f. of the random walk*)
fint[x_] :=Which[x<-1, 0, x>L-2, 0, True, f[x]]
hitmax[d_] :=Sum[f[d+k],{k,0,L}]
coord[i_,j_] :=Which[i < 1/2, fint[j-1], j==L-1, hitmax[j-i], True, fint[j-i]]
matrixcoord[i_,j_] :=coord[i-1,j-1]
KB=Array[matrixcoord, {L,L}]      (*This is the matrix KB*)
MatrixForm[KB]
```

	0	1	2	3	4	5
0	$\frac{59049}{100000}$	$\frac{6561}{20000}$	$\frac{729}{10000}$	$\frac{81}{10000}$	$\frac{9}{20000}$	$\frac{1}{100000}$
1	$\frac{59049}{100000}$	$\frac{6561}{20000}$	$\frac{729}{10000}$	$\frac{81}{10000}$	$\frac{9}{20000}$	$\frac{1}{100000}$
2	0	$\frac{59049}{100000}$	$\frac{6561}{20000}$	$\frac{729}{10000}$	$\frac{81}{10000}$	$\frac{46}{100000}$
3	0	0	$\frac{59049}{100000}$	$\frac{6561}{20000}$	$\frac{729}{10000}$	$\frac{856}{100000}$
4	0	0	0	$\frac{59049}{100000}$	$\frac{6561}{20000}$	$\frac{8146}{100000}$
5	0	0	0	0	$\frac{59049}{100000}$	$\frac{40951}{100000}$

Since a chain takes values only in  $S$  we have

$$\sum_{j \in S} K_{ij} = 1, \text{ for all } i \in S.$$

Recall that the probability measure  $\alpha$  represents the random initial state of the chain. It could, of course, be a delta function giving probability one to some initial state,  $i_0$ . Hence  $\alpha(i_0) = 1$ . A random initial state may result from the past history of the process, or may result from an explicit randomization of the starting point. Given a probability transition kernel  $K_{ij}$  and an initial probability measure  $\alpha$ , we may construct the Markov chain  $X_n$  and the probability space  $\{\Omega, \mathcal{F}, P_\alpha\}$ . The construction is given in full in Section 5.10. We do note however that the

probability of any given trajectory  $(i_0, i_1, \dots, i_n)$  of the Markov chain is determined by the kernel  $K$  and  $\alpha$  as follows:

**Proposition 5.4**

$$\begin{aligned} P_\alpha(X_0 = i_0, X_1 = i_1, \dots, X_{n-1} = i_{n-1}, X_n = i_n) \\ = \alpha(i_0)K_{i_0i_1}K_{i_1i_2} \cdots K_{i_{n-2}i_{n-1}}K_{i_{n-1}i_n}. \end{aligned}$$

**Proof:** By conditioning,

$$\begin{aligned} P_\alpha(X_0 = i_0, X_1 = i_1, \dots, X_{n-1} = i_{n-1}, X_n = i_n) \\ = P_\alpha(X_0 = i_0, X_1 = i_1, \dots, X_{n-1} = i_{n-1}) \\ \cdot P_\alpha(X_n = i_n | X_0 = i_0, X_1 = i_1, \dots, X_{n-1} = i_{n-1}) \\ = P_\alpha(X_0 = i_0, X_1 = i_1, \dots, X_{n-1} = i_{n-1}) \cdot K_{i_{n-1}i_n} \end{aligned}$$

where the last equality followed from the Markov property. Iterating we get

$$\begin{aligned} P_\alpha(X_0 = i_0, X_1 = i_1, \dots, X_{n-1} = i_{n-1}, X_n = i_n) \\ = P_\alpha(X_0 = i_0) \cdot K_{i_0i_1}K_{i_1i_2} \cdots K_{i_{n-2}i_{n-1}}K_{i_{n-1}i_n} \\ = \alpha(i_0)K_{i_0i_1}K_{i_1i_2} \cdots K_{i_{n-2}i_{n-1}}K_{i_{n-1}i_n}. \end{aligned}$$

Remark that  $K_{ij}^2 \equiv (K^2)_{ij} = \sum_{k \in S} K_{ik}K_{kj}$  and similarly

$$K_{ij}^n = \sum_{i_1 \in S} \sum_{i_2 \in S} \cdots \sum_{i_{n-1} \in S} K_{ii_1}K_{i_1i_2} \cdots K_{i_{n-2}i_{n-1}}K_{i_{n-1}j}$$

are the matrix products of  $K$  times itself,  $2, \dots, n$  times.

**Proposition 5.5**  $P_\alpha(X_n = j | X_0 = i) = K_{ij}^n$  for any initial distribution  $\alpha$ .

**Proof:** By conditioning and summing over all possible trajectories between  $i$  and  $j$  we have

$$\begin{aligned} P_\alpha(X_n = j | X_0 = i) &= \frac{P_\alpha(X_0 = i, X_n = j)}{P_\alpha(X_0 = i)} \\ &= \sum_{i_1, i_2, \dots, i_{n-1} \in S} \frac{P_\alpha(X_0 = i, X_1 = i_1, \dots, X_{n-1} = i_{n-1}, X_n = j)}{P_\alpha(X_0 = i)} \\ &= \sum_{i_1, i_2, \dots, i_{n-1} \in S} \frac{\alpha(i)K_{ii_1}K_{i_1i_2} \cdots K_{i_{n-2}i_{n-1}}K_{i_{n-1}j}}{P_\alpha(X_0 = i)} \\ &= \sum_{i_1, i_2, \dots, i_{n-1} \in S} K_{ii_1}K_{i_1i_2} \cdots K_{i_{n-2}i_{n-1}}K_{i_{n-1}j} \\ &= K_{ij}^n. \end{aligned}$$

We may immediately establish the *Chapman-Kolmogorov equation*:

**Proposition 5.6** For any  $m \leq n$ ,

$$K_{ij}^n = \sum_{k \in S} K_{ik}^m K_{kj}^{n-m}.$$

**Proof:** The process must be at some  $k \in S$  at time  $m$ , so

$$\begin{aligned} K_{ij}^n &= P_\alpha(X_n = j | X_0 = i) \\ &= \sum_{k \in S} P_\alpha(X_n = j, X_m = k | X_0 = i) \\ &= \sum_{k \in S} P_\alpha(X_n = j | X_m = k, X_0 = i) \cdot P_\alpha(X_m = k | X_0 = i) \\ &= \sum_{k \in S} P_\alpha(X_n = j | X_m = k) \cdot P_\alpha(X_m = k | X_0 = i) \\ &= \sum_{k \in S} K_{ik}^m K_{kj}^{n-m}. \end{aligned}$$

■

**Example 5.7** **Bursty ATM traffic - (5.2) continued**

By the above

$$K^n = \begin{pmatrix} 1-a & a \\ b & 1-b \end{pmatrix}^n.$$

One may diagonalize the matrix  $K$  with a similarity transformation. The eigenvalues of  $K$  are 1 and  $1 - a - b$  (note  $|1 - a - b| < 1$ ). The associated eigenvectors are

$$\begin{pmatrix} 1 \\ 1 \end{pmatrix}, \quad \begin{pmatrix} a \\ -b \end{pmatrix}.$$

The standard basis vectors  $e_1$  and  $e_2$  are:

$$\begin{pmatrix} 1 \\ 0 \end{pmatrix}, \quad \begin{pmatrix} 0 \\ 1 \end{pmatrix}.$$

We may transform our standard basis vectors  $e_1, e_2$  into a basis of eigenvectors by multiplication by  $U$  where

$$U := \begin{pmatrix} 1 & a \\ 1 & -b \end{pmatrix}.$$

The image of  $e_1$  under  $U^{-1}KU$  is  $1 \cdot e_1$  while the image of  $e_2$  under  $U^{-1}KU$  is  $(1 - a - b) \cdot e_2$ . Hence  $U^{-1}KU = D$  where

$$U^{-1} = \frac{1}{a+b} \begin{pmatrix} b & a \\ 1 & -1 \end{pmatrix}, \quad D := \begin{pmatrix} 1 & 0 \\ 0 & 1 - a - b \end{pmatrix}.$$

Hence,  $K = UDU^{-1}$ . Next, by telescoping,  $K^n = UD^nU^{-1}$ . Since  $D$  is diagonal,

$$D^n = \begin{pmatrix} 1 & 0 \\ 0 & (1 - a - b)^n \end{pmatrix}$$

so we conclude

$$K^n = \frac{1}{a+b} \begin{pmatrix} b & a \\ b & a \end{pmatrix} + \frac{(1-a-b)^n}{a+b} \begin{pmatrix} a & -a \\ -b & b \end{pmatrix}.$$

### Example 5.8 The discrete $M|M|1$ queue

Consider a processor which cycles every nanosecond. Suppose that customers arrive at the processor according to a Bernoulli process having arrival rate  $p$  customers per unit time (where  $p = \lambda/\eta$  per second). The first  $M$  in  $M|M|1$  stands for the fact that the interarrival times are geometric and hence memoryless. The customers are served one at a time in order of arrival and if the processor is busy when a customer arrives he joins the end of the queue. The service time for each customer is independent of the arrival process and has a geometric distribution with probability  $q$  of completing service in any nanosecond cycle (where  $q = \mu/\eta$ ). This service time distribution is again memoryless and hence the second  $M$  in  $M|M|1$ . Let  $M[t]$  denote the number of customers in the queue at time unit  $[t]$ .

If the queue is empty when a customer arrives, this customer's service begins in the next time slot so

$$K_{00} = 1 - p, K_{01} = p \text{ and } K_{0j} = 0 \text{ for } j \geq 2.$$

If the queue is not empty then the queue decreases by one if there is a service and no arrival. It increases by one if there is an arrival without a service. Otherwise it remains the same. Hence, for  $i \geq 1$ ,

$$K_{i,i-1} = (1-p)q, K_{i,i+1} = p(1-q), K_{ii} = (1-p)(1-q) + pq$$

and  $K_{ij} = 0$  otherwise. Notice that we might have chosen a slightly different model if we imagine that service takes place at the end of the time period in which case a customer entering an empty system might immediately be cleared. In this case we would have to make a small change to the transition probabilities from the state 0:

$$K_{00} = 1 - p(1-q), K_{01} = p(1-q) \text{ and } K_{0j} = 0 \text{ for } j \geq 2.$$

### Example 5.9 The discrete $M|G|1$ queue

Consider a processor like that in Example 5.8 except that now the service time for each customer has distribution  $G$ , where the  $G$  stands for general service distribution. We assume the service distribution has p.m.f.  $g[x]$  at nanosecond  $[x]$ . The 1

stands for one server, so an  $M|G|n$  queue differs from an  $M|G|1$  queue only in that there are  $n$  servers.

Let  $Q_n$  denote the number of customers left in the system after the  $n^{\text{th}}$  service completion. At this time the entire past of the system is summarized by the value  $Q_n$ . This follows because there is nobody being served at this time and the knowledge of when the last arrival of the discrete Bernoulli process occurred does not affect future arrivals since the Bernoulli process is memoryless. Let  $Y_n$  denote the number of customers who arrive between the  $n^{\text{th}}$  and  $(n + 1)^{\text{th}}$  service completion. Clearly,  $Q_{n+1} = (Q_n + Y_n - 1) \vee 0$ . This representation allows us to specify the transition probabilities. While we wait  $[x]$  time units for the next customer to be served,  $k$  new customers arrive with probability

$$\sum_{[x]=1}^{\infty} \binom{[x]}{k} p^k (1-p)^{[x]-k} g[x] \text{ where } \binom{[x]}{k} = 0 \text{ if } [x] < k.$$

This follows since we wait  $[x]$  time units with probability  $g[x]$  and during each of these time units, a new customer arrives with probability  $p$ .

In the case when  $Q_n = 0$ , we wait until the next customer arrives and with the above probability we see  $k$  more customers arrive while he or she gets served. Consequently, for  $i = 1, 2, \dots$

$$K_{ik} = \sum_{[x]=1}^{\infty} \binom{[x]}{k-i+1} p^{k-i+1} (1-p)^{[x]-k+i-1} g[x], \tag{5.1}$$

$$k = i - 1, i, i + 1, \dots$$

while

$$K_{0k} = \sum_{[x]=1}^{\infty} \binom{[x]}{k} p^k (1-p)^{[x]-k} g[x], \quad k = 0, 1, 2, \dots \tag{5.2}$$

This chain is called the embedded Markov chain and as we shall see, is useful in describing the stationary or steady-state regime of the queue.

## 5.2 Steady-State Markov Chains

Consider a probability transition kernel  $K_{ij}$  on a state space  $S$ . We say a state  $j$  is accessible from state  $i$  if for some  $n \geq 0$ ,  $K_{ij}^n > 0$ . We say two states  $i$  and  $j$  communicate if each is accessible from the other.

**Proposition 5.10** *The state space may be divided into disjoint sets called communication classes. States within a communication class all communicate.*

**Proof:** Suppose  $k$  communicates with both  $i$  and  $j$ . Therefore there exist  $n$  and  $m$  such that  $K_{ik}^m > 0$  and  $K_{kj}^n > 0$ . Now by the Chapman-Kolmogorov equation

$$K_{ij}^{m+n} = \sum_{\ell \in S} K_{i\ell}^m K_{\ell j}^n \geq K_{ik}^m K_{kj}^n > 0.$$

Hence  $j$  is accessible from  $i$ . Similarly  $i$  is accessible from  $j$ , so  $i$  and  $j$  communicate. Communicating states form an equivalence class so sets of communicating states are necessarily equal or disjoint. (The notion of equivalence class is reviewed in the Appendix.) ■

**Example 5.11 A reducible chain**

Consider the probability kernel

$$\begin{pmatrix} 0 & 1 & 0 & 0 \\ 1 & 0 & 0 & 0 \\ 0 & 0 & 1/2 & 1/2 \\ 0 & 0 & 1/4 & 3/4 \end{pmatrix}.$$

Clearly  $K$  has two communication classes, the first two states and the last two.

---

**Definition 5.12** We say a Markov chain is irreducible if there is only one communication class.

**Definition 5.13** We say a positive measure  $\alpha$  on  $S$  is stationary if

$$\alpha(i) = \sum_{k \in S} \alpha(k) K_{ki}$$

and is a stationary probability measure if in addition  $\sum_i \alpha(i) = 1$ .

If the initial distribution of a Markov chain is stationary probability measure  $\pi$  then

$$\begin{aligned} P_\pi(X_n = i) &= \sum_{k \in S} \pi(k) K_{ki}^n \\ &= \pi(i) \end{aligned}$$

by iteration. Hence if we start out according to a stationary initial distribution then  $X_n$  has this same distribution for all  $n$ . This does not mean the chain stops jumping from state to state! This is statistical equilibrium; only the probabilities of being in a given state are fixed.

**Definition 5.14** If a chain has a stationary probability distribution  $\pi$  we say the chain is stable.

**Example 5.15 Bursty ATM traffic - (5.7) continued**

This is a stable, irreducible Markov chain. The unique stationary measure  $\pi$  is a

vector  $\pi := (\pi(0), \pi(1))$ , satisfying  $\pi(0) + \pi(1) = 1$  and the matrix equation

$$(\pi(0), \pi(1)) = (\pi(0), \pi(1)) \begin{pmatrix} 1-a & a \\ b & 1-b \end{pmatrix}.$$

Solving this system gives  $(\pi(0), \pi(1)) = (b/(a+b), a/(a+b))$ .

**Example 5.16 A reducible chain - (5.11) continued**

We easily check that

$$(1/2, 1/2, 0, 0) \text{ or } (0, 0, 1/3, 2/3)$$

or any convex combination of these two are stationary measures. The two disjoint communication classes have individual stationary measures so we may create lots of stationary measures by weighing them in different proportions.

**Example 5.17 ATM multiplexor - - (5.3) continued**

Our ATM multiplexor multiplexes 5 trunk lines carrying noisy ATM traffic. In each time slot of one microsecond a trunk line presents a cell to the multiplexor with probability 1/10. The multiplexor sends one cell every time unit and stores the rest up to a maximum of 5 cells.  $Q_{[t]}^B$  represents the number of cells waiting in the queue at the end of each time slot (after the multiplexor has cleared one cell).  $Q_{[t]}^B$  is a Markov chain with state space  $\{0, 1, 2, 3, 4, 5\}$  and we calculated the transition kernel  $K^B$  of this chain.

We can solve the equation  $\pi = \pi K^B$  by writing it as  $\pi(K^B - I) = 0$  or  $(K^B - I)^T \pi^T = 0$  where  $T$  denotes the transpose. Consequently the column vector  $\pi^T$  is in the null space of  $(K^B - I)^T$ . We can find a vector in this null space using *Mathematica*.

```
diff=Transpose[KB-IdentityMatrix[L]]
eig=NullSpace[diff]
sol=First[eig]
total=Sum[sol[[i]],{i,1,6}]
pi=N[sol/total,3]
```

The last couple steps above simply normalized the eigenvector into a probability giving the result:

$$\begin{aligned} \pi &\equiv \{\pi(0), \pi(1), \pi(2), \pi(3), \pi(4), \pi(5)\} \\ &= \{0.500196, 0.34689, 0.116858, 0.0284007, 0.00627189, 0.00138232\}. \end{aligned}$$

It is possible to study the long run average behavior of a Markov chain using renewal theory. By Corollary 6.25,

**Theorem 5.18** *Let  $X_n$  be an irreducible Markov chain with stationary probability distribution  $\pi$ . Let  $h$  be a real valued function such that  $\sum_{i \in S} |h(i)|\pi(i) < \infty$  then with probability 1,*

$$\lim_{T \rightarrow \infty} \frac{1}{T} \sum_{s=0}^{T-1} h(X_s) = E_\pi h(X_0) = \sum_{i \in S} h(i)\pi(i).$$

*In particular,  $\lim_{T \rightarrow \infty} \frac{1}{T} \sum_{s=0}^{T-1} \chi\{X_s \in A\} = \pi(A)$ .*

**Example 5.19 ATM multiplexor - - (5.17) continued**

Our ATM multiplexor multiplexes 5 trunk lines carrying noisy ATM traffic. In each time slot of one microsecond a trunk line presents a cell to the multiplexor with probability 1/10. The multiplexor sends one cell every time unit and stores the rest up to a maximum of 5 cells.  $Q_{[t]}^B$  represents the number of cells waiting in the queue at the end of each time slot (after the multiplexor has cleared one cell).

One important consideration is the long run proportion of time the multiplexor is idle; that is the long run proportion of time the queue is empty because no cell is served if the queue starts out empty at the beginning of a time slot. According to Theorem 5.18 this long run proportion is given by

$$\lim_{T \rightarrow \infty} \frac{1}{T} \sum_{s=0}^{T-1} \chi\{Q_{[s]}^B = 0\} = \pi(0) = 0.500196$$

so we see the multiplexor is idle slightly more than 50% of the time. Another important parameter is the utilization of the multiplexor which is the long run proportion of time the multiplexor is busy. Clearly the utilization is

$$\lim_{T \rightarrow \infty} \frac{1}{T} \sum_{s=0}^{T-1} \chi\{Q_{[s]}^B > 0\} = 1 - \pi(0) = 0.499804$$

---

Proposition 5.18 can be generalized:

**Proposition 5.20** *Let  $X_n$  be an irreducible Markov chain with stationary probability distribution  $\pi$ . Let  $V[n]$  be a stochastic process defined recursively by  $V[n] = h(X_{n-1}, X_n, U_{n-1})$ . The distribution of the random variable (or vector)  $U_{n-1}$  is determined by the states  $X_{n-1}$  and  $X_n$  but is otherwise independent of the trajectory of the chain  $\{X_n, n = 0, 1, \dots\}$ . In other words if  $X_{n-1} = i$  and  $X_n = j$*



then the p.m.f. of  $U_{n-1}$  is  $f_{ij}(\cdot)$ . If  $\sum_{i,j \in S} \pi(i)K_{ij}E|h(i, j, U_0)| < \infty$  then

$$\begin{aligned} \lim_{T \rightarrow \infty} \frac{1}{T} \sum_{n=0}^T V[n] &= E_{\pi} V[0] = \sum_{i \in S} \pi(i) E(h(i, X_1, U_0) | X_0 = i) \\ &= \sum_{i,j \in S} \pi(i) K_{ij} E[h(i, j, U_0) | X_0 = i, X_1 = j] = \sum_{i,j \in S} \pi(i) K_{ij} \sum_x h(i, j, x) f_{ij}(x) \end{aligned}$$

The above proposition shows that for most practical purposes the steady state determines the long run behavior of a Markov chain.

To apply Theorem 5.18 or Proposition 5.20 we need to show the chain is stable. Often the steady state probabilities  $\pi$  can be given by exact calculation from the equilibrium equations as in the examples in this section but when the state space is countable this may not be possible.

**Theorem 5.21** *Let  $X_n$  be an irreducible Markov chain. If there exists a recurrent state  $i$ ; i.e. such that the return time to  $i$  is finite with probability one then there exists a stationary distribution which is unique up to constant multiples. If, in addition,  $\mu_{ii} < \infty$ , where  $\mu_{ii}$  is the mean return time to  $i$ , then  $\mu_{jj} < \infty$  for all  $j$  and  $X_n$  is stable with unique stationary probability distribution  $\pi(j) = 1/\mu_{jj} = \pi(i) {}_iG_{ij}$  where  ${}_iG_{ij}$  is the expected number of visits to  $j$  before a return to  $i$ .*

We prove this theorem in Section 5.9 and in Section 5.10 we will provide a means of checking the mean return time to some state is finite.

**Example 5.22 ATM multiplexor - - (5.19) continued**

Our ATM multiplexor multiplexes 5 trunk lines carrying noisy ATM traffic. In each time slot of one microsecond a trunk line presents a cell to the multiplexor with probability 1/10. The multiplexor sends one cell every time unit and stores the rest up to a maximum of 5 cells.  $Q_{[i]}^B$  represents the number of cells waiting in the queue at the end of each time slot (after the multiplexor has cleared one cell).

The cell loss rate is an important measure of the performance of the multiplexer. Let  $V_n$  denote the number of cells lost in the  $n^{th}$  time slot. Clearly if  $Q_{[n-1]}^B = i$  and  $Q_{[n]}^B = j$  then the number of cells that were lost in time slot  $[n]$  is  $h(i, j, U_{n-1}) = \chi\{j = 5\}(U_n - j + i - 1)$  where  $U_{n-1}$  is a binomial random variable representing the number of arrivals in the  $n^{th}$  time slot. The long run average number of cells lost per time slot is

$$\lim_{T \rightarrow \infty} \frac{1}{T} \sum_{n=0}^{T-1} V[n] = \sum_{i,j \in S} \pi(i) K_{ij} E[h(i, j, U_0) | Q_{[0]}^B = i, Q_{[1]}^B = j]$$

where  $V_n = h(Q_{[n-1]}^B, Q_{[n]}^B, U_{n-1})$ . Since

$$E[h(i, 5, U_0) | Q_{[0]}^B = i, Q_{[1]}^B = j] = E(U_0 - j + i - 1)^+$$

so the long run average number of cells lost per time slot is

$$\begin{aligned}
 & \sum_{i=0}^5 \pi(i) K_{i,5}^B E(U_0 - j + i - 1)^+ \\
 &= \pi(2) K_{25}^B E(U_0 - 4)^+ + \pi(3) K_{35}^B E(U_0 - 3)^+ \\
 &+ \pi(4) K_{45}^B E(U_0 - 2)^+ + \pi(5) K_{55}^B E(U_0 - 1)^+ \\
 &= (.116858)(.00026)(.00001) + \dots (.00138232)(.40951)(.09049) \\
 &= 0.0000559522
 \end{aligned}$$

Since an average of  $np = 5(0.1) = 0.5$  cells arrive per time slot we conclude that the long run proportion of cells lost is twice the above value. This loss rate seems incredibly small but in fact it is much too high! A cell loss rate of about one cell in a billion might be more acceptable. There is a delicate balance inside the multiplexor. A cell arriving at the end of a queue with  $x$  cells in it must wait  $x$  time slots to be transmitted. Hence the buffer cannot be too large or else the delay across the multiplexor is too long. On the other hand if the buffer is too small then the cell loss rate will be too large. The above calculations will help to strike the proper balance but bear in mind that our calculation depends on the noisy traffic assumption. What would happen if the traffic was bursty!

---

### 5.3 Convergence to Steady-State

The convergence of long run time averages to steady state investigated in the last section can be sharpened. For many chains, regardless of the initial distribution, the distribution after a very few transitions is approximately the stationary distribution!

#### Example 5.23 Bursty ATM traffic - (5.15) continued

By the explicit calculation of  $K^n$  we see that as  $n \rightarrow \infty$

$$\begin{aligned}
 (K_{00}^n, K_{01}^n) &\rightarrow \left( \frac{b}{a+b}, \frac{a}{a+b} \right) \\
 (K_{10}^n, K_{11}^n) &\rightarrow \left( \frac{b}{a+b}, \frac{a}{a+b} \right).
 \end{aligned}$$

In other words, it doesn't matter whether we started in 0 or 1, after some time we are in state 0 with approximate probability  $b/(a+b)$  and in state 1 with approximate probability  $a/(a+b)$ . These are precisely the steady state probabilities of the ATM chain. We note, moreover, that it doesn't take long to enter the stationary regime since the term  $(1 - a - b)^n$  converges to 0 exponentially fast.

---

Things don't always work out so nicely even if a chain is irreducible. Consider a chain having kernel

$$K = \begin{pmatrix} 0 & 1 \\ 1 & 0 \end{pmatrix}.$$

Clearly, starting in state 0, after  $n$  steps we are in state 0 with probability 1 if  $n$  is even and 0 if  $n$  is odd. Similarly, starting in state 1, after  $n$  steps we are in state 1 with probability 1 if  $n$  is even and 0 if  $n$  is odd. It is clear  $K_{00}^n$  does not converge (but  $K_{00}^{2n}$  does) and this is a nuisance we will have to watch out for.

**Definition 5.24** A state  $i$  has period  $d$  if  $d$  is the greatest common divisor of the set  $\{n : K_{ii}^n > 0\}$ . This means that if  $p$  is any other integer which divides every element of the set  $\{n : K_{ii}^n > 0\}$  then  $d$  is divisible by  $p$ . Hence,  $K_{ii}^n = 0$ , except for some times  $n$  of the form  $n = d, 2d, 3d, \dots$  and  $d$  is the *largest* integer with this property. A state with period 1 is called aperiodic. Denote the period of state  $i$  by  $d(i)$ .

**Proposition 5.25** *If  $i$  and  $j$  belong to the same communication class then  $d(i) = d(j)$ .*

**Proof:** Since  $i$  and  $j$  are in the same communication class there must exist integers  $m$  and  $n$  such that  $K_{ij}^n > 0$  and  $K_{ji}^m > 0$ . Suppose  $K_{ii}^p > 0$  then by the Chapman-Kolmogorov equation

$$K_{jj}^{m+p+n} \geq K_{ji}^m K_{ii}^p K_{ij}^n > 0.$$

Similarly,  $K_{ii}^{2p} \geq K_{ii}^p K_{ii}^p > 0$  so

$$K_{jj}^{m+2p+n} \geq K_{ji}^m K_{ii}^p K_{ii}^p K_{ij}^n > 0.$$

It follows that  $d(j)$  divides  $m + p + n$  and  $m + 2p + n$  and hence  $d(j)$  divides the difference which is  $p$ . By definition,  $d(i)$  is the greatest common divisor of all  $\{p : K_{ii}^p > 0\}$  so  $d(j)$  must be a divisor of  $d(i)$ . By symmetry  $d(i)$  must be a divisor of  $d(j)$ . Hence  $d(i) = d(j)$ . ■

If we avoid periodicity we have the following results whose proofs are deferred to the next section:

**Theorem 5.26** *If  $X_n, n \geq 0$  is an irreducible, aperiodic Markov chain having stationary probability distribution  $\pi$ , then  $\pi(j) = 1/\mu_{jj}$  where  $\mu_{jj} < \infty$  is the mean return time to  $j$ . Hence  $\pi$  is unique. Moreover*

$$\lim_{n \rightarrow \infty} \sum_{j \in S} |K_{ij}^n - \pi(j)| = 0.$$

**Corollary 5.27** Let  $X_n, n \geq 0$  be an irreducible, aperiodic Markov chain having stationary probability distribution  $\pi$ . If  $\sum_{j \in S} |f(j)|\pi(j) < \infty$  then

$$\lim_{n \rightarrow \infty} |E_i f(X_n) - \sum_{j \in S} f(j)\pi(j)| = 0.$$

**Example 5.28 The discrete  $M|M|1$  queue - (5.8) continued**

One can check by matrix multiplication that the stationary probability measure of the  $M|M|1$  queue with  $p < q$  is given by

$$\pi(0) = 1 - \frac{p}{q} \text{ and } \pi(i) = \left(1 - \frac{p}{q}\right) \frac{1}{1-q} \left(\frac{p(1-q)}{q(1-p)}\right)^i \text{ for } i = 1, 2, \dots$$

One just checks that  $\pi = \pi K$ . For  $i \geq 2$ :

$$\begin{aligned} & \pi(i-1)K_{i-1,i} + \pi(i)K_{i,i} + \pi(i+1)K_{i+1,i} \\ &= \frac{1-p/q}{1-q} \left(\frac{p(1-q)}{q(1-p)}\right)^{i-1} p(1-q) \\ & \quad + \frac{1-p/q}{1-q} \left(\frac{p(1-q)}{q(1-p)}\right)^i (pq + (1-p)(1-q)) \\ & \quad + \frac{1-p/q}{1-q} \left(\frac{p(1-q)}{q(1-p)}\right)^{i+1} q(1-p) \\ &= \pi(i). \end{aligned}$$

For  $i = 1$ :

$$\begin{aligned} & \pi(0)K_{0,1} + \pi(1)K_{1,1} + \pi(2)K_{2,1} \\ &= \left(1 - \frac{p}{q}\right)p + \frac{1-p/q}{1-q} \left(\frac{p(1-q)}{q(1-p)}\right)^1 (pq + (1-p)(1-q)) \\ & \quad + \frac{1-p/q}{1-q} \left(\frac{p(1-q)}{q(1-p)}\right)^2 q(1-p) \\ &= \pi(1). \end{aligned}$$

For  $i = 0$ :

$$\begin{aligned} & \pi(0)K_{0,0} + \pi(1)K_{1,0} \\ &= \left(1 - \frac{p}{q}\right)(1-p) + \frac{1-p/q}{1-q} \left(\frac{p(1-q)}{q(1-p)}\right)^1 q(1-p) \\ &= \pi(0). \end{aligned}$$

We also have to check that  $\sum_{i=1}^{\infty} \pi(i) = 1$ . This is easy to check as long as

$$\frac{p(1-q)}{q(1-p)} < 1 \text{ i.e. } p < q.$$

This makes good sense because  $p$  is mean arrival rate per time slot and  $q$  is the mean service rate per time slot. Customers must be served faster than they arrive or the queue will tend to grow without bound.

From Theorem 5.26 the stationary probability distribution we have calculated is unique. We just have to check that the chain is irreducible and aperiodic. From any state  $i$  there is a transition to  $i - 1$  or  $i + 1$ . A series of such transitions will obviously take us from any state to any other so the chain is irreducible. The number of transitions to return to 0 could be 1 with probability  $q$  or 2 with probability  $pq$ . The state 0 is therefore aperiodic and so is the chain.

It follows from Corollary 5.18 that the average number of time slots the queue is empty is  $\pi(0) = (1 - p/q)$ . Since  $p = \lambda/\eta$  and  $q = \mu/\eta$  where  $\eta$  is huge, it follows that as  $\eta \rightarrow \infty$ ,  $\pi(i) \sim (1 - \rho)\rho^i$  for  $n = 0, 1, \dots$  where  $\rho = \lambda/\mu$ .

Given the queue starts out with  $i$  customers, the expected number of customers in the queue at time  $n$  is  $E_i X_n = \sum_{j \in S} K_{ij}^n j$ . Define the function  $f(i) := i$  on the state space  $S = \{0, 1, 2, \dots\}$  then from Theorem 5.27, the expected number of cells in the queue is  $\sum_{j \in S} j \pi(j)$  which simplifies to

$$\sum_{j=1}^{\infty} j \frac{1-\rho}{1-q} \left( \frac{\rho(1-q)}{1-p} \right)^j = \frac{(1-\rho)}{1-q} \frac{\rho(1-q)}{1-p} \left( 1 - \frac{\rho(1-q)}{1-p} \right)^{-2} \rightarrow \frac{\rho}{1-\rho}.$$

**Example 5.29 The discrete  $M|G|1$  queue - (5.9) continued**

It is easy to check that the  $M|G|1$  queue is irreducible since a transition from 0 to any state  $i$  has positive probability while from  $i$  we can jump to  $i - 1$  with positive probability and so on down to 0. The state 0 is certainly aperiodic since we can return in 1 step (or 2 or 3). The existence of a stationary distribution  $\pi$  for the number of customers left behind after a service completion leads to the *Pollaczek-Khinchin* equation. Suppose  $\pi$  has  $z$ -transform

$$Q(z) = \sum_{k=0}^{\infty} z^k \pi(k).$$

Denote the probability generating function of the service distribution  $G$  by

$$\psi_G(t) := \sum_{[x]=1}^{\infty} t^{[x]} g[x].$$

Now  $\pi(i) = \sum_k \pi(k) K_{ki}$  so multiplying both sides by  $z^i$  and summing over  $i$ , we have

$$\begin{aligned} Q(z) &= \sum_i z^i \sum_k \pi(k) K_{ki} \\ &= \pi(0) \sum_i z^i K_{0i} + \sum_{k>0} \pi(k) \sum_i z^i K_{ki}. \end{aligned}$$

Now, using (5.2),

$$\begin{aligned}
 \pi(0) \sum_i z^i K_{0i} &= \pi(0) \sum_i z^i \sum_{[x]=1}^{\infty} \binom{[x]}{i} p^i (1-p)^{[x]-i} g[x] \\
 &= \pi(0) \sum_{[x]=1}^{\infty} \sum_i \binom{[x]}{i} (zp)^i (1-p)^{[x]-i} g[x] \\
 &= \pi(0) \sum_{[x]=1}^{\infty} (1-p+zp)^{[x]} g[x] \\
 &= \pi(0) \psi_G(1-p+zp).
 \end{aligned}$$

Now, using (5.1),

$$\begin{aligned}
 &\sum_{k>0} \pi(k) \sum_i z^i K_{ki} \\
 &= \sum_{k>0} \pi(k) \sum_{i=k-1}^{\infty} z^i \sum_{[x]=1}^{\infty} \binom{[x]}{i-k+1} p^{i-k+1} (1-p)^{[x]-i+k-1} g[x] \\
 &= \sum_{k>0} \pi(k) z^{k-1} \sum_{[x]=1}^{\infty} \sum_{i=k-1}^{\infty} \binom{[x]}{i-k+1} (zp)^{i-k+1} (1-p)^{[x]-i+k-1} g[x] \\
 &= \sum_{k>0} \pi(k) z^{k-1} \sum_{[x]=1}^{\infty} (1-p+zp)^{[x]} g[x] = \sum_{k>0} \pi(k) z^{k-1} \psi_G(1-p+zp) \\
 &= \frac{Q(z) - \pi(0)}{z} \psi_G(1-p+zp).
 \end{aligned}$$

Adding the above expressions we get the equation

$$Q(z) = \psi_G(1-p+zp) \left( \pi(0) + \frac{Q(z) - \pi(0)}{z} \right).$$

Denote  $\pi(0) = 1 - \rho$  and solve to get the discrete *Pollaczek-Khinchin* equation

$$Q(z) = \psi_G(1-p+zp) \frac{(1-\rho)(1-z)}{\psi_G(1-p+zp) - z}.$$

We must check that  $Q(z)$  is in fact the  $z$ -transform of a probability distribution, or, equivalently, that  $Q(1) = \sum_k \pi(k) = 1$ . We take the limit as  $z \rightarrow 1$ . First

$$\frac{d\psi_G(1-p+zp)}{dz} = p \frac{d\psi_G(y)}{dy} \Big|_{y=1-p+zp}.$$

Evaluating at  $z = 1$  or  $y = 1$  gives

$$\frac{d\psi_G(1-p+zp)}{dz} \Big|_{z=1} = \frac{d\psi_G(t)}{dt} \Big|_{t=1} = pm$$

where  $m$  is the mean service time measured in units.

Let  $m_G$  denote the mean service time measured in seconds so  $m_G = m/\eta$ . Next using L'Hospital's rule

$$\begin{aligned}\lim_{z \rightarrow 1} Q(z) &= \lim_{z \rightarrow 1} \psi_G(1 - p + zp) \cdot \lim_{z \rightarrow 1} \frac{\frac{d}{dz} [(1 - \rho)(1 - z)]}{\frac{d}{dz} [\psi_G(1 - p + zp) - z]} \\ &= 1 \cdot \frac{-(1 - \rho)}{pm - 1}.\end{aligned}$$

This expression can equal 1 if and only if  $\rho = pm = \lambda m_G$ . Hence the probability the steady state queue is empty is  $\pi(0) = 1 - \rho = 1 - \lambda m_G$ . Moreover,  $1 - \rho = \pi(0) > 0$  so  $\lambda m_G < 1$ . This is quite reasonable since the mean time between arrivals is  $1/\lambda$ , so we are simply requiring that on average customers are served a little faster than they arrive. If this is not true then clearly it won't be long before the queue grows without bound!

We can obtain the mean  $q_{av}$  ( $L$  in seconds) of an  $M|G|1$  queue by evaluating  $\dot{Q}(1)$  to obtain  $q_{av} = \rho + m_2 p^2 / (2(1 - \rho))$  where  $m_2$  is the second moment of the distribution  $G$  (see Exercise 5.13). We can also give the distribution of the time an tagged arriving customer will spend in the system until service completion. We observe that the distribution of the number of customers the tagged customer leaves behind has distribution  $\pi$  and that this number is precisely the number of customers who arrived during the tagged customers system time. Let  $S$  represent the system time and let  $S(z)$  be the transform of  $S$ . The number of customers that arrive during time  $S$  is a Binomial with parameters  $p$  and  $S$  and  $\pi(k)$  is the probability this Binomial takes the value  $k$ . Hence, conditioning on  $S = t$ ,

$$\begin{aligned}Q(z) &= \sum_{t=1}^{\infty} \sum_{k=0}^t z^k \binom{t}{k} p^k (1-p)^{t-k} P(S=t) \\ &= \sum_{t=1}^{\infty} \sum_{k=0}^t (1-p+pz)^k P(S=t) = S(1-p+pz).\end{aligned}$$

Consequently we can obtain the generating function  $S(z) = Q((z - (1 - p))/p)$ .

We have now characterized the stationary measure at the *time of service departure* and by Theorem 5.26, the embedded  $M|G|1$  queue may start out in any state or any initial distribution but after a few departures the distribution of the queue size after a service will tend to the stationary distribution  $\pi$ . On the other hand we are really interested in the stationary distribution at any time  $t$  not at a stopping time. The distribution at stopping times can be anything. For instance, we know the distribution of the queue at those random times when it empties completely - it is empty! Nevertheless, since the arrival process is memoryless, the state of the queue at an arbitrary fixed time does turn out to have stationary distribution  $\pi$ !

To show this we first remark that the BASTA property holds; that is Bernoulli Arrivals See Time Averages (the PASTA property holds for Poisson processes). Let  $X[t]$  be the queue size at time slot  $[t]$  and suppose a customer arrives in time slot

$[t + 1]$ ; that is  $L_{[t+1]} = 1$ . Then

$$P(X[t] = k | L_{[t+1]} = 1) = \frac{P(X[t] = k, L_{[t+1]} = 1)}{P(L_{[t+1]} = 1)} = P(X[t] = k)$$

because future arrivals are independent of the past. Hence, if  $X$  is in steady state then a Bernoulli arrival sees the queue in steady state, i.e. it sees the time average. If we can now show that the distribution of a the chain  $X_{[t]}$  left behind by service completions is the same the distribution seen by arrivals (which is steady state) then the above embedded process has the same steady state as  $X[t]$ . We leave this for the continuation of this example at (6.16).

---

### Example 5.30 The discrete $M|M|1$ queue - (5.28) continued

A simple example of a discrete time queue is the discrete time  $M|M|1$  queue where the interarrival times and the service distribution are geometric with mean  $1/p$  and  $m = 1/q$  respectively where  $q = \mu/\eta$  (recall  $p = \lambda/\eta$ ). In this case,

$$\psi_G(t) = \frac{tq}{1 - t(1 - q)}.$$

Substituting in the *Pollaczek-Khinchin* equation and simplifying we get

$$Q(z) = \frac{1 - p/q}{1 - p} (1 - p + pz) \left( 1 - \frac{p(1 - q)}{q(1 - p)} z \right)^{-1}.$$

Expanding this in powers of  $z$  we see that, for  $q > p$ ,

$$\pi(k) = \left( \frac{1 - q}{1 - p} \right)^k \left( \frac{p}{q} \right)^k \left( \frac{1 - p/q}{1 - q} \right) \approx \left( \frac{\lambda}{\mu} \right)^k \left( 1 - \frac{\lambda}{\mu} \right)$$

as  $\eta \rightarrow \infty$ . This is the formula we found in Example 5.28.

We can also rewrite  $Q(z)$  above as

$$Q(z) = \frac{(1 - \rho)(1 - p + pz)q}{1 - p - (1 - q)(1 - p + pz)} = S(1 - p + pz)$$

so

$$S(z) = \frac{(1 - \rho)zq}{1 - p - (1 - q)z} = \frac{q - p}{1 - p} z \left( 1 - \left( 1 - \frac{q - p}{1 - p} \right) z \right)^{-1}.$$

This means the distribution of the system time for an  $M|M|1$  queue is geometric with a mean of  $(1 - p)/(q - p)$  nanoseconds or approximately an exponential with a mean of  $1/(\mu - \lambda)$  seconds.

---



## 5.4 Reversible Markov Chains

Consider a stationary Markov chain  $\{X_n; 0 \leq n \leq T\}$  on a countable state space  $S$  having stationary probability measure  $\pi$  and transition kernel  $K_{ij}$  for  $i, j \in S$ . If we fix any time  $T$ , we may consider the time reversal of the original process,  $\{X_n^* = X_{T-n}; 0 \leq n \leq T\}$ , still defined on the same probability space. The evolution of this process is what we would get if we filmed the original chain from time 0 to  $T$  and then ran the film backward! Everyone knows this produces very strange results like the spilled glass of milk that reassembles itself from a million pieces and leaps up to a table top. In equilibrium however the time reversal is not so strange and is in fact just another Markov chain!

It is easy to establish the Markov property for the time reversed process and to identify the corresponding transition kernel. The Markov property holds since for  $0 \leq m < n \leq T$

$$\begin{aligned}
 & P_\pi(X_n^* = j | X_m^* = i, X_{m-1}^* = i_{m-1}, \dots, X_0^* = i_0) \\
 &= P_\pi(X_{T-n} = j | X_{T-m} = i, X_{T-m+1} = i_{m-1}, \dots, X_T = i_0) \\
 &= \frac{P_\pi(X_{T-n} = j, X_{T-m} = i, X_{T-m+1} = i_{m-1}, \dots, X_T = i_0)}{P_\pi(X_{T-m} = i, X_{T-m+1} = i_{m-1}, \dots, X_T = i_0)} \\
 &= \frac{\pi(j)P_j(X_{n-m} = i, X_{n-m+1} = i_{m-1}, \dots, X_n = i_0)}{\pi(i)P_i(X_{n-m+1} = i_{m-1}, \dots, X_n = i_0)} \\
 &\quad \text{by stationarity and the Markov property} \\
 &= \frac{\pi(j)K_{ji}^{n-m}P_i(X_{n-m+1} = i_{m-1}, \dots, X_n = i_0)}{\pi(i)P_i(X_{n-m+1} = i_{m-1}, \dots, X_n = i_0)} \\
 &\quad \text{by the Markov property} \\
 &= \frac{\pi(j)K_{ji}^{n-m}}{\pi(i)}.
 \end{aligned}$$

This means the conditional probability that the time reversed chain is in state  $j$  at time  $n$ , given the past at time  $m$ , depends only on the state at time  $m$ ; i.e. on the fact that  $X_m^* = i$ . Hence,

$$\begin{aligned}
 & P(X_n^* = j | X_m^* = i, X_{m-1}^* = i_{m-1}, \dots, X_0^* = i_0) \\
 &= P(X_n^* = j | X_m^* = i) = \frac{\pi(j)K_{ji}^{n-m}}{\pi(i)}.
 \end{aligned}$$

This is precisely the Markov property and taking  $n = m + 1$  we see the transition probabilities are homogeneous and equal and given by

$$K_{ij}^* = \frac{\pi(j)K_{ji}}{\pi(i)}.$$

**Example 5.31 A time reversed chain**

Consider the probability kernel  $K$

$$\begin{pmatrix} 1/2 & 1/2 & 0 \\ 1/3 & 1/3 & 1/3 \\ 1/2 & 1/4 & 1/4 \end{pmatrix}.$$

With a little calculation we have  $\pi = (10/23, 9/23, 4/23)$  and we see  $K^*$  is

$$\begin{pmatrix} 1/2 & 3/10 & 1/5 \\ 5/9 & 1/3 & 1/9 \\ 0 & 3/4 & 1/4 \end{pmatrix}.$$

Note that the steady state of the time reversed chain is exactly the same as the original chain since

$$\sum_i \pi(i)K_{ij}^* = \sum_i \pi(i) \frac{\pi(j)K_{ji}}{\pi(i)} = \sum_i \pi(j)K_{ji} = \pi(j).$$

In some cases the time reversed chain has the same transition kernel as the original chain, i.e.  $K_{ij}^* = K_{ij}$ . In this case we call the chain  $X$  reversible and we see this implies  $\pi(i)K_{ij} = \pi(j)K_{ji}$  since in this case

$$K_{ij} = K_{ij}^* = \frac{\pi(j)K_{ji}}{\pi(i)}$$

and the result holds by multiplying by  $\pi(i)$ .

**Example 5.32 The discrete  $M|M|1$  queue - (5.30) continued**

The steady state of the  $M|M|1$  queue is

$$\pi(0) = 1 - \frac{p}{q} \text{ and } \pi(i) = \left(1 - \frac{p}{q}\right) \frac{1}{1-q} \left(\frac{p(1-q)}{q(1-p)}\right)^i \text{ for } i = 1, 2, \dots$$

Let's show this chain is reversible. We need to show  $\pi(i)K_{i,i+1} = \pi(i+1)K_{i+1,i}$  for  $i \geq 0$ . For  $i \geq 1$ , substituting in the transition probabilities, we see that this is equivalent to

$$\begin{aligned} & \left(1 - \frac{p}{q}\right) \frac{1}{1-q} \left(\frac{p(1-q)}{q(1-p)}\right)^i \cdot p(1-q) \\ &= \left(1 - \frac{p}{q}\right) \frac{1}{1-q} \left(\frac{p(1-q)}{q(1-p)}\right)^{i+1} \cdot (1-p)q \end{aligned}$$

and this is true by cancellation. We may check the case  $i = 0$  separately. By substitution

$$\left(1 - \frac{p}{q}\right)p = \left(1 - \frac{p}{q}\right) \frac{1}{1-q} \left(\frac{p(1-q)}{q(1-p)}\right)^1 q(1-p)$$

which brings us back to  $\pi(0)K_{0,1} = \pi(1)K_{1,0}$ .

We conclude the discrete  $M|M|1$  queue is reversible and so will look the same (in a distributional sense) viewed either forward or backward in time! However the time between arrivals to the chain is geometrically distributed. Viewed backward in time these arrivals look like departures and so we conclude the time between departures is also geometrically distributed!

**Example 5.33 A time reversed chain - (5.31) continued**

Note that the kernel  $K^*$  we explicitly calculated above is not equal to  $K$  so the associated chain is not reversible. This is not surprising since  $K_{13} = 0$  which means there can never be a transition from 1 directly to 3. On the other hand  $K_{31} > 0$  which means that the time reversed process can jump from 1 to 3 since  $K_{13}^* = \pi(3)K_{31}/\pi(1) > 0$ . The time reversed process and the original process cannot be the same and so our original chain is not reversible.

Suppose we have a reversible Markov chain on a state space  $S$  which is divided into a forbidden set  $F$ , and its complement  $B$ . Let  $\pi$  denote the stationary distribution of the kernel  $K$  of this chain. Suppose those transitions from  $B$  to  $F$  are suppressed or truncated so a transition from  $i \in B$  is suppressed and then redirected back to  $i$ . Hence, for  $i \in B$ , we can define a new transition kernel

$$\tilde{K}_{ij} = \begin{cases} K_{ij} & \text{if } i, j \in B \text{ and } j \neq i \\ K_{ii} + \sum_{\ell \in F} K_{i\ell} & \text{if } i \in B \text{ and } i = j \end{cases}$$

**Lemma 5.34** *The stationary distribution of the truncated reversible Markov chain on  $B$  with transition kernel  $K$  has stationary distribution given by  $\pi(i)/\pi(B)$  for  $i \in B$ .*

**Proof:** The proof is immediate by simple calculation. Pick  $j \in B$  so

$$\begin{aligned} \sum_{i \in B} \frac{\pi(i)}{\pi(B)} \tilde{K}_{ij} &= \frac{1}{\pi(B)} \left( \sum_{i \in B, i \neq j} \pi(i)K_{ij} + \pi(j)\tilde{K}_{jj} \right) \\ &= \frac{1}{\pi(B)} \left( \sum_{i \in B} \pi(i)K_{ij} + \pi(j) \sum_{i \in F} K_{ji} \right) \\ &= \frac{1}{\pi(B)} \left( \sum_{i \in B} \pi(i)K_{ij} + \sum_{i \in F} \pi(i)K_{ij} \right) \text{ using reversibility} \\ &= \frac{1}{\pi(B)} \sum_{i \in S} \pi(i)K_{ij} = \frac{\pi(j)}{\pi(B)} \end{aligned}$$

since  $\pi$  is the stationary distribution. Finally the factor  $\pi(B)$  normalizes the measure  $\pi$ , restricted to  $B$ , to be a probability. ■

**Example 5.35 The discrete  $M|M|1$  queue - (5.32) continued**

Consider two  $M|M|1$  queues. The first has independent arrivals with probability  $p_1 = \lambda_1/\eta$  per time slot and services are completed with probability  $q_1 = \mu_1/\eta$  in any time slot (when there are customers in the queue). The second has independent arrivals with probability  $p_2 = \lambda_2/\eta$  per time slot and services are completed with probability  $q_2 = \mu_2/\eta$  in any time slot. Let the pair of queues  $X^1$  and  $X^2$  have kernels  $K^1$  and  $K^2$  as given in Example 5.8. Together they may be viewed as a Markov chain  $(X^1, X^2)$  having kernel

$$K_{(i,k),(j,\ell)} = K_{ij}^1 K_{k\ell}^2$$

and state space  $\{0, 1, \dots\} \times \{0, 1, \dots\}$ . It is immediate that the stationary distribution  $\pi$  for the joint chain is the product of the stationary distributions  $\pi^1$  and  $\pi^2$  of the marginal chains. It is also immediate that the joint chain is reversible with respect to  $\pi$ !

Let's suppose the two queues share a common customer waiting room, which seats fewer than  $L$  customers including those being served. If  $L - 1$  seats are filled (so both servers are busy) then new arrivals to either queue are sent away without service. To calculate the stationary distribution of this shared buffer we first remark that transitions to  $F := \{(i, k) : i + k \geq L\}$  are suppressed. By Lemma 5.34 the stationary distribution of the truncated chain on  $B := \{(i, k) : i + k < L\}$  has a stationary distribution  $\pi^B$  given by the restriction of  $\pi$  to  $B$ , renormalized by  $\pi(B)$  to be a probability. This is rather remarkable since the joint behavior of the shared queue is very complicated!

**5.5 Hitting Probabilities****Example 5.36 Control charts - (3.27) continued**

The Shewhart control chart is rather slow to react to a shift in the process mean. The fact is, most of the control procedures in today's standards manuals are obsolete since they were designed to minimize computation rather than have optimal statistical properties. There were no calculators and certainly no personal computers in the 1920's! The Cusum or cumulative sum procedure was proposed by Page in 1954 and has gradually been replacing Shewhart charts. It has been adopted as standard BS5703 by the British Standards Institute and surprisingly this procedure has only recently been shown to be optimal (see Moustakides (1986)).

Consider the data from Example 3.27 which has a nominal value  $\mu_0$ . Let the observed values (which are in fact the average of 5 observations) be denoted by  $X_n; n = 1, 2, \dots$  (we drop the bar). When the process is in control the  $X_i$  have mean  $\mu_0 = 1000$  and standard deviation  $50/\sqrt{5}$ . Suppose we particularly wish to guard against a positive increase or shift in the mean to  $\mu_1 = 1020$ , the so-called

rejection quality level. Define a reference parameter  $k$  and define the one-sided Cusum:

$$C_{n+1} = \max\{C_n + X_n - k, 0\}, C_0 = 0.$$

We sound an out-of-control alarm at the first  $n$  such that  $C_n > h$  where  $h$  is the signal level.

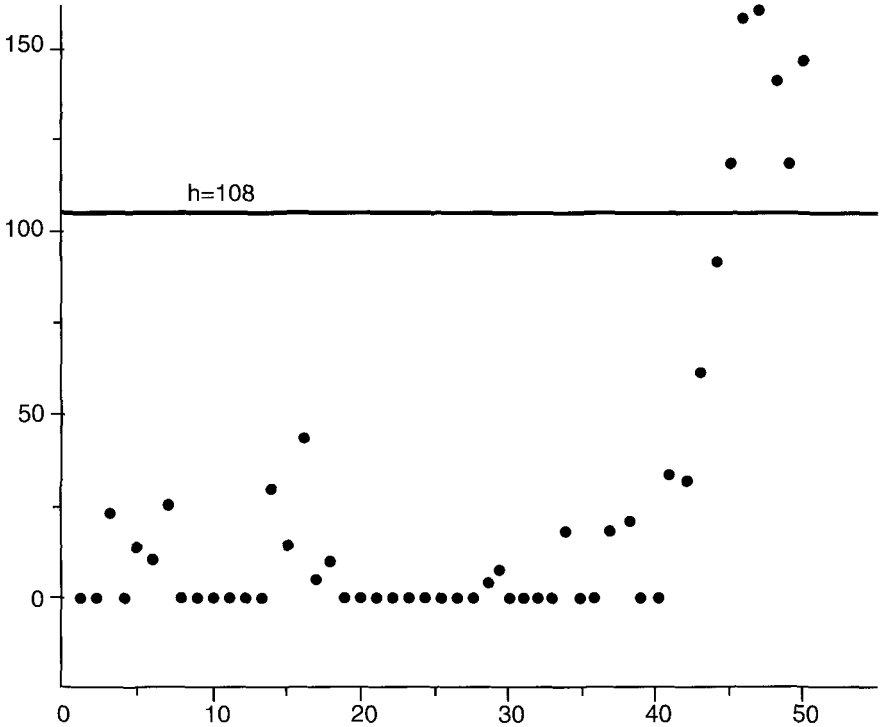

Fig. 5.4 A Cusum chart.

The reference or anchor value  $k$  is picked so that while the process in control the quantities  $X_n - k$  tend to be negative. For instance if  $k = (\mu_1 + \mu_0)/2$  (in the example we take  $k = 1010$ ) then  $X_n - k$  has a negative mean when the process is in control. Consequently the Cusum  $C_n$  tends to drift down to 0 again and again and so will cross the signal level only after a long time. On the other hand,  $k$  is picked so that in the out-of-control situation the values  $X_n - k$  tend to be positive. This holds, for instance, if  $k = (\mu_1 + \mu_0)/2$  since this is less than the shifted mean  $\mu_1$ . Consequently the Cusum  $C_n$  tends to drift up to the signal level so an alarm will soon be signalled.

The sequence  $C_n$  is a Markov chain. In Figure 5.4, the signal level is  $h = 108$  and it might be reasonable to have a level of discretization  $d = 10$ . In this case, we

divide the real line into intervals of length  $\delta = h/(d-0.5) = 11.37$ . Then we identify the states  $\{0, 1, 2, \dots, 9\}$  with the centers of the intervals at  $0, \delta, 2\delta, \dots, (d-1)\delta$ ; that is with  $0, 11.37, 22.74, \dots, 102.33$  and  $h = (\delta/2) +$  center of the last interval. We can add a state  $F = \{10\}$  as a forbidden state which represents the interval  $(108, \infty]$ .

In the above example, the on-target distribution,  $F$ , of  $X$  is a normal with mean 1000 and standard deviation  $50/\sqrt{5}$ . We calculate the discretized probabilities of  $X - k$  by  $f(j) = P(X - k \in (j\delta - \delta/2, j\delta + \delta/2])$  for  $j = \dots, -2, -1, 0, 1, 2, \dots$ . We now wish to describe the transition kernel for the discretized chain on  $0, 1, 2, \dots, 10$ . Let

$$K_{ij} := \begin{cases} f(j-i) & \text{for } 0 \leq i < d, j > 0 \\ \sum_{k \leq -i} f(k) & \text{for } 0 \leq i < d, j = 0 \\ \sum_{k \geq d-i} f(k) & \text{for } 0 \leq i < d, j = d \\ 1 & \text{for } i = d, j = d. \end{cases}$$

We can also calculate the transition kernel for the discretized chain when the process is off-target. In this case the distribution of  $X$  is a normal with mean 1020 and standard deviation  $50/\sqrt{5}$ . Plugging in this new distribution gives the off-target discretized transition kernel.

The task is now to calculate the expected number of transitions before  $C_n$  enters the interval  $(h, \infty)$ . This is equivalent to the discretized chain entering the forbidden state 10. We are consequently interested in describing the transient behavior of a chain before it enters the forbidden state. This requires a bit more theory. With this theory we can pick the reference and signal parameters to fix the average run length of the procedure when the process is on-target and off-target. In this example the in-control average run length is set to be 500 observations.

---

Consider a Markov chain which starts out in a set  $B$  but which eventually jumps out of  $B$  into an absorbing set  $F$  where  $B \cup F = S$ . The hitting time  $\tau_F$  is defined by  $\tau_F := \min\{n > 0; X_n \in F\}$  and we assume  $P(\tau_F < \infty) = 1$ .

Also for  $i, j \in B$  define  $A_{ij}^n := P_i(\tau_F > n, X_n = j)$ , the probability of visiting  $j$  on the  $n^{\text{th}}$  step before being absorbed into  $F$  having started in  $i$ . For  $i, j \in B$ ,  $A_{ij} := A_{ij}^1$  can be viewed as the transition kernel of the chain on  $B$ . Of course the rows of this kernel do not add to 1 since eventually the chain jumps to  $F$ . Once the chain enters  $F$  we stop it. Represent  $K$  as

$$K := \begin{pmatrix} A & H \\ R & N \end{pmatrix}$$

where  $A$  is a kernel on  $B$ ,  $N$  is a kernel on  $F$  and  $H$  specifies the transition probabilities from  $B$  to  $F$ . The stopped chain has kernel  $\tilde{K}$ :

$$\tilde{K} := \begin{pmatrix} A & H \\ 0 & I \end{pmatrix} \quad (5.3)$$

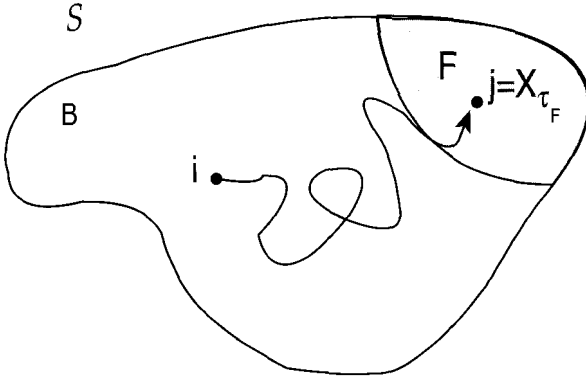

Fig. 5.5  $\tau_F$  is the time to hit  $F$ .

where the identity matrix  $I$  causes the states in  $F$  to be absorbing.

**Example 5.37 ATM multiplexor - (5.22) continued**

Consider the ATM multiplexor which multiplexes 5 trunk lines carrying noisy ATM traffic. As before we assume that in each time slot of one microsecond a trunk line presents a cell to the multiplexor with probability  $1/10$ .  $Q_{[t]}$  represents the number of cells waiting in the queue at the end of each time slot (after the multiplexor has cleared one cell).  $Q_{[t]}$  is a Markov chain on the state space  $S = \{0, 1, 2, \dots\}$ . In Figure 5.3, the queue initially contains two cells and reaches overload after 4 time slots.

We saw the number of cells that may arrive at time  $[t]$  is a Binomial random variable  $B_{[t]}$  with  $n = 5$  and  $p = 1/10$ . Let  $b(k; 5, 0.1) := P(B_{[t]} = k)$ . The transition kernel is given by

$$K_{ij} = \begin{cases} b(j; 5, 0.1) & \text{if } i = 0, \\ b(j - i + 1; 5, 0.1) & \text{if } i > 0, -1 \leq j - i \leq 4 \\ 0 & \text{otherwise.} \end{cases}$$

Let the forbidden set be  $F = \{6, 7, 8, \dots\}$  and let  $B = \{0, 1, 2, 3, 4, 5\}$ . This corresponds to having a multiplexor buffer which holds only 5 cells (presumably because a delay longer than 5 time units is unacceptable). The matrix  $A$  defined above may be calculated using *Mathematica* as in Figure 5.6.

By matrix multiplication we see

$$\tilde{K}^n := \begin{pmatrix} A^n & \sum_{k=0}^{n-1} A^k H \\ 0 & I \end{pmatrix}.$$

Consequently  $A_{ij}^n$  gives the probability of starting at  $i \in B$ , staying in  $B$  up to time  $n$  and entering  $j \in B$  at time  $n$ .

```

L=6      (*We assume the buffer only holds 5 cells*)
M=5      (*There are 5 input trunk lines*)
p=1/10   (*Each line delivers a cell with probability p*)

```

```

bin[x_] :=bin[x]=Binomial[M,x] p^(x) (1-p)^(M-x)
f[x_] :=bin[x+1] (*f is the p.m.f. of the random walk*)
fint[x_] :=Which[x<-1, 0,x>4, 0, True, f[x]]
coord[i_,j_] :=Which[i < 1/2, fint[j-1], True,
fint[j-i]]
matrixA[i_,j_] :=coord[i-1,j-1]
A=Array[matrixA, {L,L}]
(*This is the matrix A*)
MatrixForm[A]

```

	0	1	2	3	4	5
0	$\frac{59049}{100000}$	$\frac{6561}{20000}$	$\frac{729}{10000}$	$\frac{81}{10000}$	$\frac{9}{20000}$	$\frac{1}{100000}$
1	$\frac{59049}{100000}$	$\frac{6561}{20000}$	$\frac{729}{10000}$	$\frac{81}{10000}$	$\frac{9}{20000}$	$\frac{1}{100000}$
2	0	$\frac{59049}{100000}$	$\frac{6561}{20000}$	$\frac{729}{10000}$	$\frac{81}{10000}$	$\frac{9}{20000}$
3	0	0	$\frac{59049}{100000}$	$\frac{6561}{20000}$	$\frac{729}{10000}$	$\frac{81}{10000}$
4	0	0	0	$\frac{59049}{100000}$	$\frac{6561}{20000}$	$\frac{729}{10000}$
5	0	0	0	0	$\frac{59049}{100000}$	$\frac{6561}{20000}$

Fig. 5.6 Create the transition matrix  $A$ .

The chance of staying in  $B$  up until time  $n$  and then jumping to  $j \in F$  at time  $n+1$  is given by  $\sum_{k \in B} A_{ik}^n H_{kj}$ . Consequently, the probability of hitting  $j \in F$  the first time we leave  $B$  is given by

$$\sum_{n=0}^{\infty} \sum_{k \in B} A_{ik}^n H_{kj} = \sum_{k \in B} (I - A)_{ik}^{-1} H_{kj} = \sum_{k \in B} {}_F G_{ik} H_{kj} \quad (5.4)$$

where

$$I + A + A^2 + \dots = (I - A)^{-1} =: {}_F G.$$

Note that in the special case where  $F = \{j\}$

$$f_{ij}^{n+1} = P(\tau_F = n+1, X_{n+1} = j | X_0 = i) = \sum_{k \in B} A_{ik}^n H_{kj}.$$



As usual, let  $\tau_F$  be the time to hit  $F$ . Note that for  $i \in B$

$$\begin{aligned} E_i \tau_F &= \sum_{n=0}^{\infty} P(\tau_F > n | X_0 = i) \\ &= \sum_{n=0}^{\infty} \sum_{j \in B} (A^n)_{ij} = \sum_{j \in B} \sum_{n=0}^{\infty} (A^n)_{ij} = \sum_{j \in B} (I - A)^{-1}_{ij} \\ &= \sum_{j \in B} {}_F G_{ij}. \end{aligned}$$

This means we can calculate the mean time to hit  $F$  from any starting point. Let this time be denoted by  $m_F(i)$ . By the Markov property it follows that for  $i \in B$ ,  $m_F(i) = 1 + \sum_{j \in S} A_{ij} m_F(j)$  since to reach  $F$ , one must take one step to a point  $j$  and from  $j$  it will take a time  $m_F(j)$  to reach  $F$ . Since  $m_F(i) = 0$  for  $i \in F$  it follows that  $m_F(i) = 1 + \sum_{j \in B} A_{ij} m_F(j)$ . If we rewrite this equation we get

$$\sum_{j \in B} (I_{ij} - A_{ij}) m_F(j) = 1 \text{ or } (I - A) \mathbf{m}_F = \mathbf{1}$$

in matrix form. The solution to this matrix equation is precisely  ${}_F G \mathbf{1}$  where  $\mathbf{1}$  is a column of ones.

**Example 5.38 ATM networks - (5.37) continued**

Applying the above result to the ATM example we may calculate the mean time until the queue exceeds 5 cells. The table below gives the time until overload starting with  $\{0, \dots, 5\}$  cells. We remark that the mean hitting time is practically independent of the starting point  $i \in B$ . This is because the chain returns to 0 many times before finally exiting  $B$  so in fact we need only consider the mean hitting time from  $i = 0$ .

```
potential=N[Inverse[IdentityMatrix[L]-A],6]
MatrixForm[potential]
vectorones=Table[1,{i,6}]
ulttime=N[potential . vectorones,6]
MatrixForm[ulttime]
```

The preceding code gives the following table of the mean time to overload starting with 0 to 5 cells in the queue:

0	1	2	3	4	5
6531.79	6531.79	6524.75	6485.72	6301.92	5539.43

**Example 5.39 Control charts - (5.36) continued**

Applying the above methods to the Cusum allows us to calculate the on and off-target run lengths for any given reference and signal values  $k$  and  $h$ . The corresponding Mathematica code to generate the transition matrix  $A$  according to the

recipe in Example 5.36 is given below.

```

n=5                (* Sample size *)
mu=1000           (* Expected average *)
sigma=50.0 /Sqrt[n] (* Standard deviation of the sample *)
k=1010           (* Reference parameter *)
h=108            (* Signal level *)
d=10             (* Level of discretization *)
delta=h/(d-0.5)  (* Length of intervals *)

(* Normal distribution function *)
Gaussian[x_]:=Exp[-(x+k-mu)^2/(2 sigma^2)]/(Sqrt[2 Pi] sigma)

(* Discretized probability *)
f[j_]:= NIntegrate[Gaussian[x],
                 {x,j*delta-delta/2,j*delta+delta/2}]
(* Left tail probability *)
LeftSum[j_]:=NIntegrate[Gaussian[x],
                      {x,-Infinity,j*delta+delta/2}]
(* Right tail probability *)
RightSum[j_]:=NIntegrate[Gaussian[x],
                       {x,j*delta-delta/2,Infinity}]
(* Transition kernel *)
K[i_,j_]:= If [i==d && j<d,0,If [i==d && j==d,1,
    If [i<d && j==d, RightSum[d-i],
    If [i<d && j==0, LeftSum[-i], f[j-i]]]]]

JumpMatrix=Table[K[i,j],{i,0,d-1},{j,0,d-1}];
MinusOneVector=Table[-1,{d}];
RunLengths=LinearSolve[JumpMatrix-IdentityMatrix[d],
                      MinusOneVector]

```

Executing this program we get the on-target run lengths for all initial states  $i = 0, 1, \dots, 9$  which correspond to starting the Cusum with a headstart of 0, 11.37, 22.74, ...:

```
{489.5, 488.1, 485.5, 480.7, 472.6, 459.4, 438.0, 404.2, 353.6, 285.2}
```

We remark that the signal level  $h$  did indeed set the on-target run length at approximately 500 when the Cusum has no headstart. With a finer discretization it would be exactly 500. Modifying this program we can get the off-target run lengths for all initial headstarts:

```
{10.99, 10.35, 9.55, 8.63, 7.63, 6.58, 5.50, 4.40, 3.35, 2.44}
```

Sometimes it makes sense to start the Cusum with a nonzero headstart. This

might be the case when there is a substantial chance at startup that the production equipment is not regulated properly. If we start at  $i = 6$  which corresponds to starting the Cusum at 70.2 the on-target run length is still 438.0 but the off-target run length is reduced by half.

---

### Example 5.40 Nonparametric control charts

The run length distribution for both in and out of control cases depend on the on-target and off-target distributions. It may be unrealistic, particularly during a start-up phase of production, to assume these are known. We can always plot an empirical Shewhart  $\bar{x}$ -chart but this depends heavily on the assumption of normality so we can't fix the on-target run length.

One solution is to design a nonparametric Cusum procedure whose on-target run length distribution does not depend on the unknown on-target distribution  $F$ , which we do assume to be continuous. This can be accomplished by sequentially ranking the quality measurements. Define the sequential ranks

$$R_i = 1 + \sum_{k=1}^{i-1} \chi\{X_k - X_i < 0\}.$$

It is an interesting exercise (see Exercise 5.26) to show that, when the process is in control, the sequential ranks  $R_i$  take the values  $\{1, 2, \dots, i\}$  with probability  $1/i$  and form an independent sequence of random variables. If the process is in control the variables  $U_i = R_i/(i+1)$  are therefore independent and uniformly distributed on

$$\left\{ \frac{1}{i+1}, \frac{2}{i+1}, \dots, \frac{i}{i+1} \right\}.$$

We may now construct a Cusum procedure using the  $U_i$ :

$$N_{i+1} = \max\{N_i + U_i - k, 0\}, N_0 = 0 \text{ where } k \text{ is some anchor value.}$$

Since the  $U_i$  are essentially uniform on  $[0, 1]$ , we can approximate the run length distribution until this nonparametric Cusum exceeds a signal level  $h$ , by calculating the run length distribution for a Cusum with uniformly distributed quality measurements. Since the mean on-target run length should be large, the difference between these two Cusums will be negligible. The anchor value  $k$  will be greater than 0.5 since we wish the Cusum to drift downward when the process is on-target. This will be so since  $EU_i = 0.5$ . The nonparametric Cusum for the same data set yielding the parametric Cusum in Figure 5.4 is given in Figure 5.7. A signal level of  $h = 1.20$  will yield an on-target run length of 500 so we see an alarm is indeed signalled soon after the point of change.

The above procedure is sequential and if the process is in control, then the average run length does not depend on the distribution of the quality measurements. If, however, the process goes out of control and the distribution changes abruptly to

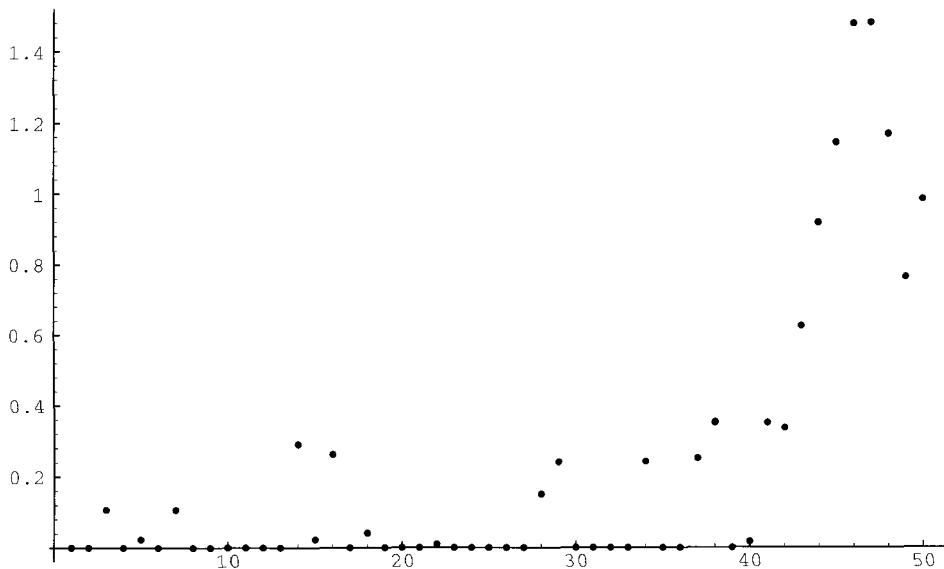

Fig. 5.7 A nonparametric Cusum chart.

a stochastically larger distribution,  $G$  say, then the sequential ranks will be higher than expected. Consequently, the  $U_i$  will be larger than expected, with a mean greater than  $.5 - k$  and if this mean is positive the Cusum will drift up to  $h$  and an alarm will be signalled.

---

### Example 5.41 Rare Events

Let  $(M_n)_{n=0}^{\infty}$  be an irreducible, recurrent Markov chain with kernel  $K$  and stationary distribution  $\pi$ . Let  $F$  be a forbidden set such that  $\pi(F)$  is very small. In this example we consider a sequence of forbidden sets such that  $\pi(F) \rightarrow 0$  and we show the hitting time  $\tau_F$  is approximately exponentially distributed. For notational ease we suppress  $F$  from our notation. Fix  $i_0 \in B = F^c$  to be a regeneration point. Let the return time  $X$  to  $i_0$  have p.m.f.  $g$  and mean  $\mu$ . Denote the sequence of i.i.d. return times as  $\{X_n\}$ . Each of these excursions can be classified as a success or failure depending on whether we hit  $F$  or not. Let  $p$  denote the probability of a success and let  $M$  denote the number of trials until success. Since the generations are independent,  $M$  is geometric with parameter  $p$ . Note that the expected number of visits to  $F$  before returning to  $i_0$  is  $\pi(F)/\mu$  by Proposition 5.21 so certainly  $p \rightarrow 0$  as  $\pi(F) \rightarrow 0$ .

The return time p.m.f  $g$  can be decomposed in two parts. Let  $g^f$  denote the conditional return distribution given the generation is a failure; that is we don't hit  $F$ , and let  $g^s$  denote the conditional return distribution given the generation is a

success; that is we do hit  $F$ . Hence

$$g = (1 - p)g^f + pg^s.$$

If the mean of  $g^f$  is  $\mu^f$  and the mean of  $g^s$  is  $\mu^s$ , then

$$\mu = (1 - p)\mu^f + p\mu^s.$$

Note also that since the mean of  $g$  is finite we can pick an  $x_0$  such that

$$\sum_{x > x_0} xg[x] \leq \epsilon$$

where  $\epsilon$  is arbitrarily small. Hence

$$\sum_{x > x_0} xpg^s[x] \leq \sum_{x > x_0} xg[x] \leq \epsilon.$$

This means that

$$\begin{aligned} p\mu^s &= \sum_{x \leq x_0} xpg^s[x] + \sum_{x > x_0} xpg^s[x] \\ &\leq px_0 + \epsilon. \end{aligned}$$

Since  $p \rightarrow 0$  as  $\pi(F) \rightarrow 0$  and since  $\epsilon$  is arbitrarily small we conclude  $p\mu^s \rightarrow 0$  as  $\pi(F) \rightarrow 0$ . This means that asymptotically those trajectories which reach  $F$  albeit long and strange trajectories nevertheless contribute nothing to the mean return time  $\mu$ ; that is  $\mu/\mu^f \rightarrow 1$ .

Let  $\tau$  denote the first time we hit  $F$  and let  $R$  denote the return time to  $i_0$  after first hitting  $F$ . Since this time occurs after  $M - 1$  generations of failure but before the  $M$ th return we have

$$\sum_{n=1}^{M-1} X_n < \tau < \sum_{n=1}^M X_n \equiv R. \tag{5.5}$$

Taking the expectation of both sides and conditioning on  $M$  we get

$$\sum_{m=1}^{\infty} (1 - p)^{m-1} p(m - 1)\mu^f < \mu_\tau < \sum_{m=1}^{\infty} (1 - p)^{m-1} p[(m - 1)\mu^f + \mu^s]$$

or

$$\left(\frac{1}{p} - 1\right)\mu^f < \mu_\tau < \left(\frac{1}{p} - 1\right)\mu^f + \mu^s = E_{i_0} R.$$

Note that since  $p \rightarrow 0$  as  $\pi(F) \rightarrow 0$ , it follows from the above that  $\mu_\tau \rightarrow \infty$ . Multiplying through by  $p$  and recalling  $\mu/\mu^f \rightarrow 1$  and  $p\mu^s \rightarrow 0$  as  $\pi(F) \rightarrow 0$  we get

**Proposition 5.42** *If the stationary probability  $\pi(F)$  of a sequence of forbidden sets  $F$  tend to 0, then the probability  $p$  of hitting  $F$  before a return to  $i_0$  tends to 0*

and the mean time  $\mu_\tau$  to hit the forbidden set tends to  $\infty$ . Moreover,

$$\lim_{\pi(F) \rightarrow 0} \frac{p\mu_\tau}{\mu} = 1 \text{ and } \lim_{\pi(F) \rightarrow 0} \frac{E_{i_0}R}{\mu_\tau} = 1.$$

Finally, the distribution of  $\tau/\mu_\tau$  converges weakly to an exponential distribution.

**Proof:** The asymptotic behavior of  $\mu_\tau$  and  $E_{i_0}R$  has been established above and the only part left to prove is the asymptotic exponentiality of  $\tau/\mu_\tau$  and we can only give a plausibility argument here. Just calculate the moment generating function of the expressions in (5.5). Conditioning on  $M$  and remembering that the cycles are independent we get, as above,

$$\begin{aligned} E \exp\left(t \sum_{n=1}^{M-1} X_n\right) &= \sum_{m=1}^{\infty} (1-p)^{m-1} p (\phi^f(t))^{m-1} \\ &= \frac{p}{(1 - (1-p)\phi^f(t))} \end{aligned}$$

where  $\phi^f(t)$  is the moment generating function of  $g^f$ . Since we are only dealing with positive random variables the above expression is certainly finite if  $t < 0$ . Similarly, since the last successful generation is also independent of the previous generations we have

$$\begin{aligned} E \exp\left(t \sum_{n=1}^M X_n\right) &= E \exp\left(t \sum_{n=1}^{M-1} X_n\right) E \exp(tX_M) \\ &= \frac{p}{(1 - (1-p)\phi^f(t))} \phi^s(t) \end{aligned}$$

where  $\phi^s(t)$  is the moment generating function of  $g^s$ . Multiplying by  $t < 0$  reverses the inequalities in (5.5) so when we take transforms

$$\frac{p}{(1 - (1-p)\phi^f(t))} > \phi_\tau(t) > \frac{p}{(1 - (1-p)\phi^f(t))} \cdot \phi^s(t) \quad (5.6)$$

where  $\phi_\tau(t)$  is the moment generating function of the time  $\tau$ .

Now we want to investigate the moment generating function of  $p\tau/\mu$  and this is

$$E \exp\left(\frac{up\tau}{\mu}\right) = \phi_\tau\left(\frac{pu}{\mu}\right).$$

Substituting  $t = wp/\mu$  into (5.6) we get

$$\begin{aligned} \frac{p}{((1-p)(1 - \phi^f(\frac{pw}{\mu})) + p)} \phi^s\left(\frac{pw}{\mu}\right) &> E \exp\left(\frac{pw\tau}{\mu}\right) \\ &> \frac{p}{((1-p)(1 - \phi^f(\frac{pw}{\mu})) + p)}. \end{aligned}$$

Now as  $\pi(F) \rightarrow 0$ ,  $p \rightarrow 0$  and  $\mu_\tau \rightarrow \infty$ . Therefore by the properties of the moment generating function  $\phi^s(wp/\mu) \rightarrow 1$ ,  $\phi^f(wp/\mu) \rightarrow 1$  and  $(\phi^f)'(0) = \mu^f$  so it

follows that

$$\frac{1}{p}(\phi^f(\frac{pw}{\mu}) - 1) \sim w \frac{\mu^f}{\mu} \rightarrow w$$

since  $\mu/\mu^f \rightarrow 1$ . From the above we get

$$\lim_{\pi(F) \rightarrow 0} E \exp(\frac{pw\tau}{\mu}) = \frac{1}{1-w}$$

since both the upper and lower bound tend to this value. We have shown above that  $p\mu_\tau/\mu \rightarrow 1$  so this gives

$$\lim_{\pi(F) \rightarrow 0} E \exp(\frac{w\tau}{\mu_\tau}) = \frac{1}{1-w}.$$

The function  $(1-u)^{-1}$  is the moment generating function of an exponential random variable with mean 1. We conclude that the time  $\tau$  scaled by its mean  $\mu_\tau$  has a moment generating function which is asymptotically equal to that of an exponential. It therefore seems reasonable that  $\tau/\mu_\tau$  should converge weakly to an exponential random variable. This is true but to prove it we must appeal to the continuity theorem for moment generating functions and this is slightly beyond the scope of this text. ■

---

## 5.6 Proofs of Convergence to Steady State

Consider an irreducible Markov chain on a countable (or finite) state space. We show Theorem 5.26 holds using results from the chapter on renewal theory.

**Lemma 5.43** *Suppose  $\alpha$  is a stationary measure. If  $\alpha(j) > 0$  for some  $j \in S$  then  $\alpha(i) > 0$  for all  $i \in S$  and*

$$\frac{K_{ij}^n}{\alpha(j)} \leq \frac{1}{\alpha(i)} \text{ uniformly in } j.$$

**Proof:**

$$\alpha(i) = \sum_{k \in S} \alpha(k) K_{ki}^n \geq \alpha(j) K_{ji}^n \text{ for all } n.$$

Since  $i$  is accessible from any  $j \in S$  there exists an  $n$  such that  $K_{ji}^n > 0$ . Hence if  $\alpha(j) > 0$  then  $\alpha(i) > 0$  for any  $i \in S$ . Using stationarity,

$$\frac{K_{ij}^n}{\alpha(j)} = \frac{K_{ij}^n}{\sum_{k \in S} \alpha(k) K_{kj}^n} \leq \frac{K_{ij}^n}{\alpha(i) K_{ij}^n} = \frac{1}{\alpha(i)}. \tag{5.7}$$

This upper bound is independent of  $j$  so we have our result. ■

We now establish the fact that after a few transitions the chain is close to its steady state.

**Theorem 5.44** *If  $M_n, n \geq 0$  is an irreducible, aperiodic Markov chain then*

$$\lim_{n \rightarrow \infty} K_{ij}^n = \frac{1}{\mu_{jj}} \quad (5.8)$$

where  $\mu_{jj}$  is the mean recurrence time to  $j$ ; that is,  $\mu_{jj} = E(\tau_j | M_0 = j)$  where  $\tau_j = \min\{n : M_n = j\}$ . If  $\mu_{kk} < \infty$  for some state  $k$  then  $\mu_{jj} < \infty$  for all  $j$  and  $\pi$  defined by  $\pi(j) = 1/\mu_{jj}$  for all  $j \in S$  is the unique stationary probability.

**Proof:**

(5.8) follows from Theorem 6.43 in Section 6.4 in the chapter on renewal theory.

$$\begin{aligned} \pi(j) &= \frac{1}{\mu_{jj}} = \lim_{n \rightarrow \infty} K_{jj}^{n+m} = \lim_{n \rightarrow \infty} \sum_{k \in S} K_{jk}^n K_{kj}^m \\ &= \liminf_{n \rightarrow \infty} \sum_{k \in S} K_{jk}^n K_{kj}^m \geq \sum_{k \in S} \liminf_{n \rightarrow \infty} K_{jk}^n K_{kj}^m \\ &= \sum_{k \in S} \frac{1}{\mu_{kk}} K_{kj}^m = \sum_{k \in S} \pi(k) K_{kj}^m. \end{aligned}$$

Above we used Fatou's Lemma 9.5 with  $K_{jk}^n = u_n(k)$  and  $K_{kj}^m = v_m(k)$ .

If  $\pi(k) > 0$  for some  $k$  then  $\pi(j) > 0$  for all  $j$  by the above. In this case

$$\begin{aligned} \pi(j) &= \lim_{n \rightarrow \infty} K_{jj}^n = \lim_{n \rightarrow \infty} \sum_{k \in S} K_{jk}^{n-1} K_{kj} = \lim_{n \rightarrow \infty} \sum_{k \in S} \frac{K_{jk}^{n-1}}{\pi(k)} \pi(k) K_{kj} \\ &= \sum_{k \in S} \pi(k) K_{kj} \end{aligned}$$

using dominated convergence since  $K_{jk}^{n-1}/\pi(k)$  tends to 1 and is uniformly bounded in  $k$  by Lemma 5.43 and  $\sum_{k \in S} \pi(k) K_{kj} \leq \pi(j)$ . At this point we have shown that  $\pi$  is stationary.

Again by Fatou's Lemma,

$$\sum_{j \in S} \pi(j) = \sum_{j \in S} \liminf_{n \rightarrow \infty} K_{ij}^n \leq \liminf_{n \rightarrow \infty} \sum_{j \in S} K_{ij}^n = \liminf_{n \rightarrow \infty} 1 = 1$$

so  $\sum_{j \in S} \pi(j) \leq 1$ . Moreover, given  $\pi(j) > 0$  for all  $j$ , we get

$$\sum_{j \in S} \pi(j) = \sum_{j \in S} \lim_{n \rightarrow \infty} K_{ij}^n = \sum_{j \in S} \lim_{n \rightarrow \infty} \frac{K_{ij}^n}{\pi(j)} \pi(j) = \lim_{n \rightarrow \infty} \sum_{j \in S} \frac{K_{ij}^n}{\pi(j)} \pi(j)$$

where the above limit may be taken outside the sum since  $K_{ij}^n/\pi(j)$  taken as a function of  $j$  is bounded by the constant  $1/\pi(i)$  by Lemma 5.43. A constant function



is of course integrable with respect to  $\pi$  which we now know is finite. Hence,

$$\sum_{j \in S} \pi(j) = \lim_{n \rightarrow \infty} \sum_{j \in S} K_{ij}^n = \lim_{n \rightarrow \infty} 1 = 1.$$

Consequently  $\pi$  is a probability measure when the mean return times are finite.

Suppose  $\alpha$  is another stationary probability. For any  $n$  we have  $\sum_i \alpha(i) K_{ij}^n = \alpha(j)$ . Now for  $j$  fixed,  $K_{ij}^n$  is a bounded function in  $i$  converging pointwise, so by the Dominated Convergence Theorem

$$\alpha(j) = \lim_{n \rightarrow \infty} \sum_i \alpha(i) K_{ij}^n = \sum_i \alpha(i) \frac{1}{\mu_{jj}} = \frac{1}{\mu_{jj}}.$$

Hence  $\alpha$  is equal to  $\pi$  so  $\pi$  must be the unique stationary probability. ■

**Example 5.45 ATM networks - (5.15) continued**

The stationary measure of the bursty ATM source is

$$(b/(a + b), a/(a + b)).$$

This agrees with the above result since the mean return time to state 0 for the kernel

$$\begin{pmatrix} 1 - a & a \\ b & 1 - b \end{pmatrix}$$

may be calculated by conditioning on the first transition. If the jump is from 0 to 0 then the time is 1. If however the jump is to state 1 then the mean return time to 0 is 1 plus the mean time to leave state 1. The time to leave state 1 and return to 0 is a geometric random variable with mean  $1/b$ . Hence the mean return time is

$$(1 - a) \cdot 1 + a \cdot (1 + 1/b) = (a + b)/b = 1/\pi(0).$$

**Example 5.46 The discrete  $M|M|1$  queue - (5.30) continued**

Define the busy period to be those times when the queue is not empty. It follows from Theorem 5.44 that the mean busy  $\mu_{00}$  is  $\pi(0)^{-1} = (1 - p/q)^{-1}$ .

**Proof of Theorem 5.26:**

$$\lim_{n \rightarrow \infty} \sum_{j \in S} |K_{ij}^n - \pi(j)| = \lim_{n \rightarrow \infty} \sum_{j \in S} \left| \frac{K_{ij}^n}{\pi(j)} - 1 \right| \pi(j).$$

By Theorem 6.43  $\lim_{n \rightarrow \infty} K_{ij}^n = \pi_j$  so  $K_{ij}^n/\pi(j) \rightarrow 1$ . Since the function  $|K_{ij}^n/\pi(j) - 1|$  is bounded by the constant  $1 + 1/\pi(i)$  by (5.7) dominated convergence gives the result. ■

**Proof of Corollary 5.27:** By the definition of the expectation

$$\begin{aligned} E_i f(X_n) - \sum_{j \in S} f(j) \pi(j) &= \sum_{j \in S} (K_{ij}^n - \pi(j)) f(j) \\ &= \sum_{j \in S} \left( \frac{K_{ij}^n}{\pi(j)} - 1 \right) f(j) \pi(j). \end{aligned}$$

Using Theorem 5.26 we know that for any  $j$ ,  $K_{ij}^n / \pi(j) \rightarrow 1$ . If the state space is finite then the conclusion follows immediately.

If  $S$  is infinite we can use Lemma 5.43 to show

$$\left| \left( \frac{K_{ij}^n}{\pi(j)} - 1 \right) f(j) \right| \leq \left( \frac{1}{\pi(i)} + 1 \right) |f(j)|$$

and by hypothesis the above function of  $j$  is integrable with respect to  $\pi$ . The result follows from the Dominated Convergence Theorem 9.7. ■

**Theorem 5.47** *The conclusions of Theorem 5.26 and Corollary 5.27 hold for an aperiodic, irreducible Markov chain on a finite state space.*

**Proof:** We must show  $\mu_{jj} < \infty$  for some state  $j$ . Denote the return time to  $j$  by  $\tau_j$ . From any initial state  $i$  there exists some  $N_i$  such that  $K_{ij}^{N_i} > 0$ . Let  $N = \prod_{i \in S} N_i$  and  $N$  is finite since  $S$  is finite. Hence for all  $i \in S$ ,  $K_{ij}^N > \epsilon$  for some  $\epsilon > 0$ .

Hence,

$$\mu_{jj} = E_j \tau_j = \sum_{n=0}^{\infty} P(\tau_j > n) \leq \sum_{m=0}^{\infty} NP(\tau_j > mN)$$

since clearly  $P(\tau_j > n)$  is decreasing for  $n$  between  $mN$  and  $(m+1)N - 1$ .

$$\begin{aligned} P(\tau_j > mN) &\leq P_j(M_{kN} \neq j, k = 1, \dots, m) \\ &= \sum_{x_1, x_2, \dots, x_m \neq j} K_{j, x_1}^N K_{x_1, x_2}^N \cdots K_{x_{m-1}, x_m}^N \\ &\leq (1 - \epsilon)^m \end{aligned}$$

using the hypothesis. Hence,

$$E_j \tau_j \leq \sum_{m=0}^{\infty} NP(\tau_j > mN) \leq \sum_{m=0}^{\infty} N(1 - \epsilon)^m < \infty. \quad \blacksquare$$

### 5.7 Transience and Recurrence

**Definition 5.48** Let  $F$  be a subset of  $S$ . The hitting time  $\tau_F$  is the first time the chain lands in or hits  $F$ .  $\tau_F$  is defined by

$$\tau_F := \min\{n > 0; X_n \in F\}$$

if  $X_n \in F$  for some  $n > 0$ , and by  $\tau_F = \infty$  if  $X_n \notin F$  for all  $n > 0$ . If  $F = \{j\}$  we denote the hitting time by  $\tau_j$ . Also define  $f_{ij}^n := P_i(\tau_j = n)$ , the probability of visiting  $j$  for the first positive time on the  $n^{\text{th}}$  step having started in  $i$ . Since  $\tau_j > 0$  by definition it follows that  $f_{ij}^0 = 0$  for all  $j$ , even  $j = i$ . Lastly let  $f_{ij} := \sum_{n=1}^{\infty} f_{ij}^n$  denote the probability of ever hitting  $j$  from  $i$ .

We now give a version of the Markov property for hitting times. This will be extended to the strong Markov property in Theorem 5.58. To state this result it is best to define precisely what we mean by the past before some stopping time.

**Definition 5.49** Let  $\tau$  be a stopping time relative to the sequence of  $\sigma$ -algebras  $\mathcal{F}_n = \sigma(X_0, X_1, \dots, X_n)$ . An event  $A$  belongs to the past before  $\tau$ , which is denoted by  $\mathcal{F}_\tau$ , if for all times  $n$ , the event  $A \cap \{\tau \leq n\}$  belongs to  $\mathcal{F}_n$ .

Intuitively,  $A \in \mathcal{F}_\tau$  means that, if  $\tau = n$ , we can decide whether or not a sample point  $\omega$  is in  $A$  based only on knowing  $X_0(\omega), X_1(\omega), \dots, X_n(\omega)$ .

**Proposition 5.50** Let  $A$  be an event in the past before  $\tau$  then

$$P(A \cap \{X_\tau = i; X_{\tau+n} = j\}) = P(A \cap \{X_\tau = i\})K_{ij}^n.$$

In particular, let  $\tau$  be the hitting time  $\tau_F$  above. This proposition then states that, given we hit the set  $F$  first at state  $i \in F$ ,  $n$  steps later we are at state  $j$  with probability  $K_{ij}^n$ . In other words, the past up to time  $\tau_F = i$  is summarized by the present state at time  $\tau_F$ , i.e.  $X_\tau = i$  and given the present, the future is independent of the past.

**Proof:** Conditioning on  $\tau$ , we get

$$\begin{aligned} & P(A \cap \{X_\tau = i; X_{\tau+n} = j\}) \\ &= \sum_{m=0}^{\infty} P(A \cap \{\tau = m, X_m = i; X_{m+n} = j\}) \\ &= \sum_{m=0}^{\infty} \sum_{i_0, i_1, \dots, i_{m-1}} \chi_H(i_0, i_1, \dots, i) P(X_0 = i_0, \dots, X_m = i; X_{m+n} = j) \end{aligned}$$

since by definition the event  $A \cap \{\tau = m\}$  is in  $\mathcal{F}_m$  and so may be expressed as  $\{(X_0, X_1, \dots, X_m) \in H\}$ , where  $H$  is a subset of  $S^{m+1}$ . The indicator  $\chi_H$  is a deterministic function which is either 1 or 0 depending on whether or not the sequence  $(i_0, i_1, \dots, i)$  is in  $H$  or not.

Now, conditioning on  $X_0 = i_0, X_1 = i_1, \dots, X_m = i$  and using the Markov property we have

$$\begin{aligned} & P(A \cap \{X_\tau = i; X_{\tau+n} = j\}) \\ &= \sum_{m=0}^{\infty} \sum_{i_0, i_1, \dots, i_{m-1}} \chi_H(i_0, i_1, \dots, i) K_{ij}^n P(X_0 = i_0, \dots, X_m = i) \\ &= K_{ij}^n \sum_{m=0}^{\infty} \sum_{i_0, i_1, \dots, i_{m-1}} \chi_H(i_0, i_1, \dots, i) P(X_0 = i_0, \dots, X_m = i; \tau = m) \\ &= K_{ij}^n P(A \cap \{X_\tau = i\}). \end{aligned}$$

### Lemma 5.51

$$K_{ij}^n = \sum_{m=0}^n f_{ij}^m K_{jj}^{n-m} \text{ for } n \geq 1.$$

**Proof:** Since we started in  $i$  we must reach  $j$  for the first time at  $\tau_j$ . Condition on  $\tau_j$  and we get

$$\begin{aligned} K_{ij}^n &= \sum_{m=1}^n P_i(X_n = j, \tau_j = m) \\ &= \sum_{m=1}^n P_i(X_n = j | \tau_j = m) \cdot P_i(\tau_j = m) \\ &= \sum_{m=1}^n f_{ij}^m K_{jj}^{n-m} \end{aligned}$$

by Proposition 5.50 and the Markov property. ■

We define the  $z$ -transform or probability generating function of  $K_{ij}^n$  and of  $f_{ij}^n$ :

**Definition 5.52** For  $|z| \leq 1$

$$K_{ij}(z) := \sum_{n=0}^{\infty} K_{ij}^n z^n, \quad f_{ij}(z) := \sum_{n=0}^{\infty} f_{ij}^n z^n.$$

**Proposition 5.53** For  $|z| \leq 1$

$$K_{jj}(z) = \frac{1}{1 - f_{jj}(z)} \text{ and } K_{ij}(z) = f_{ij}(z)K_{jj}(z) \text{ if } i \neq j.$$

**Proof:** For  $n > 0$  the coefficient of  $z^n$  in  $f_{ij}(z)K_{jj}(z)$  is

$$\sum_{m=1}^n f_{ij}^m K_{jj}^{n-m}$$

which by Lemma 5.51 is precisely the coefficient of  $z^n$  in  $K_{jj}(z)$ . By definition  $f_{jj}^0 = 0$  but  $K_{jj}^0 = 1$ , so  $f_{jj}(z)K_{jj}(z) = K_{jj}(z) - 1$ . Solving for  $K_{jj}(z)$  gives the first result. Similarly, for  $i \neq j$ , the coefficient of  $z^n$  in the product  $f_{ij}(z)K_{jj}(z)$  is

$$\sum_{m=1}^n f_{ij}^m K_{jj}^{n-m}$$

which by Lemma 5.51 is precisely the coefficient of  $z^n$  in  $K_{ij}(z)$ . This is the second equality. ■

**Definition 5.54** A state  $j$  is called recurrent if  $P_j(\tau_j < \infty) = 1$ ; that is  $f_{jj} = 1$ . It is called transient if  $P_j(\tau_j < \infty) < 1$ ; that is  $f_{jj} < 1$ . State  $j$  is positive recurrent if  $\mu_{jj} < \infty$ . If a state  $j$  is recurrent but  $\mu_{jj} = \infty$  we say the state  $j$  is null recurrent.

Let  $N(j)$  be the total number of visits to  $j$  and let  $G(i, j)$  denote the expected number of visits to  $j$  for a Markov chain starting in  $i$ ; so  $G(i, j) = E(N(j)|X_0 = i)$ . To calculate this quantity we first represent the number of visits to  $j$  by

$$N(j) = \sum_{n=0}^{\infty} \chi_{\{j\}}(X_n)$$

where the function  $\chi_{\{j\}}(X_n)$  counts 1 if the chain is at  $j$  at time  $n$  and 0 otherwise. Taking the expectation we get

$$\begin{aligned} G(i, j) &= \sum_{n=0}^{\infty} E(\chi_{\{j\}}(X_n)|X_0 = i) \\ &= \sum_{n=0}^{\infty} P_i(X_n = j) \\ &= \sum_{n=0}^{\infty} K_{ij}^n. \end{aligned}$$

**Proposition 5.55** A state  $j$  is recurrent if and only if  $G(j, j) = \infty$ .

**Proof:** By the monotone convergence theorem

$$\lim_{z \uparrow 1} K_{jj}(z) = G(j, j) \text{ and } \lim_{z \uparrow 1} f_{jj}(z) = P_j(\tau_j < \infty) = f_{jj}.$$

By 5.53, for  $|z| \leq 1$ ,  $K_{jj}(z) = 1/(1 - f_{jj}(z))$ . It follows that  $G(j, j)$  is infinite if and only if  $f_{jj} = 1$ ; that is if and only if  $j$  is recurrent. ■

**Proposition 5.56** Suppose  $i$  and  $j$  are in the same communication class. Then  $i$  is recurrent if  $j$  is. Also  $\mu_{ii} < \infty$  if  $\mu_{jj} < \infty$ .

**Proof:** Let  $m$  and  $n$  be such that  $K_{ij}^m > 0$  and  $K_{ji}^n > 0$ . Now, using the Chapman-Kolmogorov relation,  $K_{jj}^{m+k+n} \geq K_{ji}^m K_{ii}^k K_{ij}^n$ . Hence,

$$G(j, j) \geq \sum_{k=0}^{\infty} K_{jj}^{n+k+m} \geq K_{ji}^m K_{ij}^n \sum_{k=0}^{\infty} K_{ii}^k = \infty,$$

using Proposition 5.55. The proof that all states in a communication class have finite means if one does is delayed to Section 5.9. ■

We see therefore that, for an irreducible chain, all the states are recurrent if one is! We also see that a recurrent state is visited infinitely often. A transient state is visited only a finite (stochastic) number of times and moreover, the expected number of visits is finite.

If the chain is not irreducible then some states may be transient while others are recurrent. Nevertheless, starting from  $i$ , we either never visit a recurrent state  $j$  or we visit an infinite number of times. This is not really surprising since once the chain makes it to  $j$  the strong Markov property implies that the starting point  $i$  is forgotten and we know we return infinitely often to  $j$ .

**Example 5.57 Drunkard's walk - (2.78)** Consider a drunk constrained to walk unit steps on a straight line. Starting from 0, the drunk takes steps of +1 or -1 every time unit in a totally random fashion. The drunk will almost certainly return at some time to his starting point! This follows from the above characterization of recurrence. Indeed  $K_{00}^{2n+1} = 0$ ,  $n = 0, 1, 2, \dots$  and

$$\begin{aligned} K_{00}^{2n} &= \binom{2n}{n} \left(\frac{1}{2}\right)^n \left(\frac{1}{2}\right)^n \\ &= \frac{(2n)!}{n!n!} \left(\frac{1}{2}\right)^{2n}. \end{aligned}$$

Using Stirling's formula (we shall assume this without proof but see Feller Volume I for the full story):

$$n! \sim n^{n+\frac{1}{2}} e^{-n} \sqrt{2\pi}$$

we get

$$K_{00}^{2n} \sim \frac{1}{\sqrt{\pi n}}.$$

Therefore

$$G(0, 0) = \sum_{n=0}^{\infty} K_{00}^{2n} = \infty.$$

We conclude by Proposition 5.55 that 0 is a recurrent state.

By a similar calculation one may prove that a drunk walking on a plane who randomly takes steps of size 1, north, south, east or west every time unit necessarily returns to the origin. A drunk astronaut is not so fortunate. He has a nonzero probability of simply wandering away to infinity on the three dimensional lattice!

### 5.8 Existence and the Strong Markov Property

We now consider the construction of a Markov chain  $\{X_n; n = 0, 1, 2, \dots\}$  taking values in a countable state space  $S$  along with the probability space  $\{\Omega, \mathcal{F}, P_\alpha\}$  on which  $X_n$  is defined, given an initial distribution  $\alpha$  and a probability transition kernel  $K$ . As in Example 2.4 we construct a canonical sample space  $\Omega = S \times S \times S \times \dots$ , and as in Example 2.10 we construct the subalgebra  $\mathcal{F}_n$  of all unions of atomic events of the form

$$A = \{(i_0, i_1, i_2, \dots, i_n)\} \times S \times S \times \dots$$

where  $i_k, k = 0, 1, 2, \dots$  is some specific sequence in  $S$ . As before we define  $\mathcal{F}$  to be the smallest  $\sigma$ -algebra which contains all the  $\mathcal{F}_n$ .  $X_n$ , the state of the Markov chain at time  $n$ , is simply the  $n^{th}$  coordinate function defined on  $\Omega$ .

According to Proposition 5.4 we must define the probability of these atomic events as follows:

$$\begin{aligned} P^n(X_0 = i_0, X_1 = i_1, \dots, X_{n-1} = i_{n-1}, X_n = i_n) \\ = \alpha(i_0)K_{i_0i_1}K_{i_1i_2} \cdots K_{i_{n-2}i_{n-1}}K_{i_{n-1}i_n}. \end{aligned}$$

The probability of an arbitrary event in  $\mathcal{F}_n$  is given by additivity. To check that there exists a probability  $P_\alpha$  on  $\{\Omega, \mathcal{F}\}$  which agrees with  $P^n$  on  $\mathcal{F}_n$ , we must check the compatibility condition in the Kolmogorov Extension Theorem 2.73. We recall that a sequence of probability measures  $P^n$  defined on  $\mathcal{F}_n$  satisfies the compatibility condition if  $P^{n+1}(A) = P^n(A)$  if  $A \in \mathcal{F}_n$ . It suffices to check this for atomic events since events in  $\mathcal{F}_n$  are countable unions of atomic events. Let

$$A = \{(i_0, i_1, i_2, \dots, i_n)\} \times S \times S \times \dots.$$

Hence,

$$\begin{aligned} P^{n+1}(A) &= \sum_{i_{n+1} \in S} \alpha(i_0)K_{i_0i_1}K_{i_1i_2} \cdots K_{i_{n-2}i_{n-1}}K_{i_{n-1}i_n}K_{i_ni_{n+1}} \\ &= \alpha(i_0)K_{i_0i_1}K_{i_1i_2} \cdots K_{i_{n-2}i_{n-1}}K_{i_{n-1}i_n} \\ &= P^n(A). \end{aligned}$$

The compatibility condition therefore is verified so  $P_\alpha$  exists.

By the definition of  $P_\alpha$  we have

$$\begin{aligned} P_\alpha(X_0 = i) &= P_\alpha(\{i\} \times S \times S \times \cdots) \\ &= P^0(\{i\} \times S \times S \times \cdots) \\ &= \alpha(i). \end{aligned}$$

Therefore the chain we have constructed does have initial distribution  $\alpha$ . The Markov property follows in a similar manner (see Exercise 5.5).

Using Kolmogorov's extension theorem we may prove the definitive strong Markov property. First, consider any random variable  $Y = f(X_0, X_1, \dots)$  and define the shift to time  $t$  of  $Y$  by  $\theta_t Y = f(X_t, X_{t+1}, \dots)$ . Hence  $\theta_t Y$  depends on the future of the Markov chain  $X_n$  beyond time  $t$ .

**Theorem 5.58 (The Strong Markov Property)** *Let  $\tau$  be a stopping time for the sequence of  $\sigma$ -algebras  $\mathcal{F}_n = \sigma(X_0, X_1, \dots, X_n)$  and let  $E \in \mathcal{F}_\tau$ . If  $E|Y| < \infty$ , i.e.  $Y$  is integrable, then*

$$E(\chi_E \cdot \theta_\tau Y) = \sum_{j \in S} P(E \cap \{X_\tau = j\}) E_j Y.$$

**Corollary 5.59** *Under the hypotheses of 5.58*

$$E(\theta_\tau Y | X_\tau = j) = E_j Y.$$

This means the future evolution of the process beyond time  $\tau$  is entirely determined by the fact that the state at time  $\tau$  is  $j$ . The process restarts anew as if at time 0 it started in state  $j$ .

**Proof of Theorem 5.58:** If we refer to the proof of Proposition 5.50 we get an immediate extension.

$$\begin{aligned} P(E \cap \{X_\tau = i, X_{\tau+1} = j_1, \dots, X_{\tau+m} = j_m\}) \\ &= P(E \cap \{X_\tau = i\}) K_{ij_1} K_{j_1 j_2} \cdots K_{j_{m-1} j_m} \\ &= P(E \cap \{X_\tau = i\}) P_i(X_0 = j_0, X_1 = j_1, \dots, X_m = j_m). \end{aligned}$$

Next consider a set  $A \in \mathcal{F}_m$  so  $Y = \chi_A = \chi_H(X_0, X_1, \dots, X_m)$  where  $H \in S^{m+1}$ . Moreover  $\theta_\tau Y$  is the indicator of the shift to time  $\tau$  of  $A$  which we denote by  $\theta_\tau A$ . This event is in the future of time  $\tau$  and  $\theta_\tau Y$  can be represented by  $\chi_H(X_\tau, X_{\tau+1}, \dots, X_{\tau+m})$ . Summing over the points  $(j_0, j_1, \dots, j_m) \in H$  in the above equation, we get

$$P(E \cap \{X_\tau = i\} \cap \theta_\tau A) = P(E \cap \{X_\tau = i\}) P_i(A).$$

The above equality may now be extended to arbitrary  $A \in \mathcal{F}$  since it holds for all cylinder sets. Next consider simple functions of the form  $Y = \sum y_k \chi_{A_k}$ . By linearity it follows that

$$E(\chi_{E \cap \{X_\tau = i\}} \cdot \theta_\tau Y) = P(E \cap \{X_\tau = i\}) E_i(Y).$$



Now use monotone convergence to extend the result to all positive random variables  $Y$  and finally use linearity to get the result for integrable random variables. ■

**Example 5.60 Drunkard’s walk - (2.78) continued**

$M_n = x + S_n$  is a Markov chain with  $M_0 = x$ .  $T$  is the stopping time when  $M_n$  first hits the boundary  $L$  or  $U$ . Let  $f(x) = P(M_T = L)$ . Assume  $L < x < U$ , so it takes at least one step to reach the boundary. Hence,  $\theta_1 M_T = M_T$ . By the Markov property

$$\begin{aligned} f(x) &= P(M_T = L) = E[\theta_1 \chi\{M_T = L\}] \\ &= \sum_y P(M_1 = y) E_y[\chi\{M_T = L\}] \\ &= P(M_1 = x - 1)f(x - 1) + P(M_1 = x + 1)f(x + 1) \\ &= \frac{1}{2}f(x - 1) + \frac{1}{2}f(x + 1). \end{aligned} \tag{5.9}$$

We conclude from equation (5.9) that for  $L < x < U$

$$f(x) = \frac{1}{2}f(x - 1) + \frac{1}{2}f(x + 1). \tag{5.10}$$

Clearly  $f(L) = 1$  and  $f(U) = 0$ . One solution of this linear system satisfying the boundary conditions of  $f(L) = 1$  and  $f(U) = 0$  is  $f(x) = (U - x)/(U - L)$ . If there were another solution, say  $g$ , then  $h(x) = f(x) - g(x)$  is also a solution of equation (5.10), such that  $h(L) = 0$  and  $h(U) = 0$ . Equation (5.10) clearly cannot have a local maximum at any point  $x_0$  in  $(L, U)$ , for otherwise  $h(x_0)$  would be the average of two smaller values, an impossibility. Hence the maximum of  $h$  is attained on the boundary  $\{L, U\}$  so  $h \leq 0$ . Repeating the argument with  $-h$  yields  $h \geq 0$ , so  $h$  is 0 everywhere. Hence  $f$  is unique. We conclude the probability the random walk, starting at  $x$ , hits  $L$  before  $U$  is  $(U - x)/(U - L)$ . This is the result we already obtained in Example 2.78.

The limit of this probability as  $U \rightarrow \infty$  is 1. Hence the probability of the walk wandering gradually away to  $\infty$  is 0. The walk returns with probability one to  $L$  and we conclude that this simple random walk is *recurrent*. In fact we will see it is null recurrent!

---

**5.9 The Watched Process**

Consider an irreducible, recurrent Markov chain  $X_n$  and consider some subset  $A$  in the state space. If we watch the chain  $X_n$  only when it returns to  $A$ , we obtain the process watched on  $A$ . More precisely define  $\tau_A(n)$  to be the  $n^{th}$  return time to  $A$  where  $\tau_A(0) = 0$ . Let  $W_n = X_{\tau_A(n)}$ . Take  $i, j \in A$ . Take  $Y = \chi\{X_{\tau_A(1)} = j\}$  so

$$\theta_{\tau_A(n)} Y = \chi\{X_{\tau_A(n+1)} = j\} = \chi\{W_{n+1} = j\}$$

since the shift  $\theta_{\tau_A(n)}$  cuts off the trajectory of  $X$  before time  $\tau_A(n)$ . By Theorem 5.58, with  $\tau$  taken to be  $\tau_A(n)$ ,

$$\begin{aligned} &P(W_0 = i_0, \dots, W_{n-1} = i_{n-1}, W_n = i, W_{n+1} = j) \\ &= P(W_0 = i_0, \dots, W_{n-1} = i_{n-1}, X_{\tau_A(n)} = i, \theta_{\tau_A(n)}Y) \\ &= P(W_0 = i_0, \dots, W_{n-1} = i_{n-1}, X_{\tau_A(n)} = i)P_i(X_{\tau_A(1)} = j) \\ &= P(W_0 = i_0, \dots, W_{n-1} = i_{n-1}, W_n = i)P_i(W_1 = j). \end{aligned}$$

Hence, conditioning on the event  $\{W_0 = i_0, \dots, W_{n-1} = i_{n-1}, W_n = i\}$  we get

$$P(W_{n+1} = j | W_n = i, W_{n-1} = i_{n-1}, \dots, W_0 = i_0) = P_i(W_1 = j).$$

This means the process  $W_n$  is a Markov chain with a stationary transition kernel.

We next examine the transition kernel  ${}_A K$  for the process on  $A$ . Define

$${}_A K_{ij}^m = P_i(X_m = j; X_n \in A^c, 1 \leq n < m) = P_i(X_m = j, \tau_A \geq m) \quad (5.11)$$

which gives the probability, starting in  $i$ , of hitting  $j$  (which may or may not be in  $A$ ) on the  $m^{\text{th}}$  step, having stayed in  $A^c$  in the preceding steps. Next extend the definition of  ${}_A G_{ij}$ :

$${}_A G_{ij} = \sum_{m=1}^{\infty} {}_A K_{ij}^m.$$

For  $j \notin A$  this represents the expected number of visits to  $j$  after time 0 before hitting  $A$ . If  $j \in A$  then this represents the probability of hitting the set  $A$  at  $j$  having started at  $i$ . Note that  ${}_A G_{ij}$  is the transition probability  ${}_A K_{ij}$  between two states,  $i$  and  $j$  in  $A$ , of the process on  $A$ .

### Lemma 5.61

$${}_A G_{ij} = K_{ij} + \sum_{k \in A^c} {}_A G_{ik} K_{kj} \text{ for } i \in A.$$

**Proof:** Recall that, by definition, any matrix to the power 0 is the identity.

$$\begin{aligned}
 {}_A G_{ij} &= \sum_{m=1}^{\infty} \sum_{k \in S} K_{ik} \tilde{K}_{kj}^{m-1} \text{ where } \tilde{K} \text{ was defined at (5.3)} \\
 &= K_{ij} + \sum_{m=2}^{\infty} \sum_{k \in A^c} K_{ik} \tilde{K}_{kj}^{m-1} \\
 &= K_{ij} + \sum_{m=2}^{\infty} \sum_{k \in A^c} \sum_{m \in A^c} K_{ik} A_{km}^{m-2} K_{mj} \\
 &= K_{ij} + \sum_{m=2}^{\infty} \sum_{\ell \in A^c} {}_A K_{i\ell}^{m-1} K_{\ell j} \\
 &= K_{ij} + \sum_{\ell \in A^c} \sum_{m=1}^{\infty} {}_A K_{i\ell}^m K_{\ell j} \\
 &= K_{ij} + \sum_{\ell \in A^c} {}_A G_{i\ell} K_{\ell j}.
 \end{aligned}$$

■

**Theorem 5.62** Suppose the process on  $A$  has an invariant measure  $\pi_A$  so

$$\pi_A(j) = \sum_{i \in A} \pi_A(i) {}_A G_{ij} \text{ for } j \in A.$$

Define  $\sigma(k) := \sum_{i \in A} \pi_A(i) {}_A G_{ik}$  for any  $k \in S$ . Then  $\sigma(j) = \pi_A(j)$  for all  $j \in A$  and  $\sigma$  is invariant for  $K$ .

**Proof:**  $\sigma(j) = \pi_A(j)$  for all  $j \in A$  by definition. For  $\ell \in B$ ,

$$\begin{aligned}
 \sum_{k \in S} \sigma(k) K_{k\ell} &= \sum_{k \in A} \pi_A(k) K_{k\ell} + \sum_{k \in A^c} \sigma(k) K_{k\ell} \\
 &= \sum_{i \in A} \pi_A(i) K_{i\ell} + \sum_{i \in A} \pi_A(i) \sum_{k \in A^c} {}_A G_{ik} K_{k\ell} \\
 &= \sum_{i \in A} \pi_A(i) \left[ K_{i\ell} + \sum_{k \in A^c} {}_A G_{ik} K_{k\ell} \right] \\
 &= \sum_{i \in A} \pi_A(i) {}_A G_{i\ell} \text{ by Lemma 5.61} \\
 &= \sigma(\ell) \text{ by definition.}
 \end{aligned}$$

■

**Theorem 5.63** Suppose an irreducible, recurrent Markov chain has an invariant measure  $\sigma$ . If  $\sigma(A) = 1$  then  $\sigma(j) = \sum_{i \in A} \sigma(i) {}_A G_{ij}$ .

**Proof:** We first show

$$\sigma(j) = \sum_{m=1}^n \sum_{i \in A} \sigma(i) {}_A K_{ij}^m + \sum_{i \in A^c} \sigma(i) {}_A K_{ij}^n. \quad (5.12)$$

For  $n = 1$ , (5.12) follows from the definition of an invariant measure. Now suppose (5.12) holds for some  $n$ . The last term in (5.12) can be written

$$\begin{aligned} \sum_{i \in A^c} \sigma(i) {}_A K_{ij} &= \sum_{k \in S} \sigma(k) \sum_{i \in A^c} K_{k,i} {}_A K_{ij}^n \\ &= \sum_{k \in A} \sigma(k) \sum_{i \in A^c} K_{k,i} {}_A K_{ij}^n + \sum_{k \in A^c} \sigma(k) \sum_{i \in A^c} K_{k,i} {}_A K_{ij}^n \\ &= \sum_{k \in A} \sigma(k) {}_A K_{kj}^{n+1} + \sum_{k \in A^c} \sigma(k) {}_A K_{kj}^{n+1}. \end{aligned}$$

Now using (5.12) one obtains that (5.12) holds for  $n + 1$ .

Letting  $n \rightarrow \infty$  we get

$$\sigma(j) \geq \sum_{i \in A} \sigma(i) {}_A G_{ij} \text{ for all } j \in S. \quad (5.13)$$

However for  $j \in A$ ,  ${}_A G_{ij} = {}_A K_{ij}$  and  $\sum_{j \in A} {}_A K_{ij} = 1$  by recurrence. Hence if (5.13) is an inequality for some  $j \in A$  then

$$1 = \sum_{j \in A} \sigma(j) > \sum_{j \in A} \sum_{i \in A} \sigma(i) {}_A K_{ij} = \sum_{i \in A} \sigma(i).$$

This is impossible so  $\sigma(j) = \sum_{i \in A} \sigma(i) {}_A K_{ij}$  for all  $j \in A$ . This means that  $\sigma$  is the stationary probability for the process on  $A$ .

Now suppose there exists a  $j \in A^c$  and a subsequence  $n_k$  such that the second term in (5.12) does not go to zero. Pick some  $m$  and  $i_0 \in A$  such that  ${}_A K_{i_0 j}^m \geq \epsilon > 0$ . Hence,

$$\sum_{i \in A^c} \sigma(i) {}_A K_{i i_0}^{n_k+m} \geq \sum_{i \in A^c} \sigma(i) {}_A K_{ij}^{n_k} {}_A K_{j i_0}^m \quad (5.14)$$

$$\geq \delta \epsilon > 0. \quad (5.15)$$

This contradicts the above result so we conclude  $\sum_{i \in A^c} \sigma(i) {}_A K_{ij}^n \rightarrow 0$  for all  $j \in S$ . Therefore taking the limit as  $n \rightarrow \infty$  in (5.12) we have our result. ■

**Corollary 5.64** Any two invariant measures  $\rho$  and  $\sigma$  are constant multiples of each other.

**Proof:** Pick  $A = \{i\}$ . By division we can normalize each measure so  $\rho(A) = \sigma(A) = 1$ . Hence, by Theorem 5.63,  $\rho(j) = {}_A G_{ij}$  and  $\sigma(j) = {}_A G_{ij}$ . In other words, before normalization  $\sigma$  and  $\rho$  are multiples. ■

**Proof of Theorem 5.21:** Again take  $A = \{i\}$ . Of course  $\sigma_A(j) = \chi\{i = j\}$  is a stationary probability measure for the watched process on  $A$ . Theorem 5.62 allows

us to extend to an invariant measure  $\sigma$  such that  $\sigma(j) = \sigma_A(j) = 1$ . Note that by irreducible  $\sigma(j) > 0$  for all  $j$ .

The chain must be recurrent if  $\mu_{ii} < \infty$  because otherwise there is a positive probability  $\tau_j = \infty$ . Hence we again can construct an invariant measure  $\sigma$ . Note that  ${}_A G_{ik}$  is the expected number of visits to  $k$  before hitting  $A$ . Now sum over all the states  $k \in A^c$ , and we get the expected number of jumps after starting from  $i$  until a return visit to  $i$ ; that is  $E_i \tau_i$ . Hence

$$\sum_{k \in S} {}_A G_{ik} = E_i \tau_i = \mu_{ii} < \infty.$$

Hence,

$$\sigma(S) = \sum_{i \in A} \sigma_A(i) \sum_{k \in S} {}_A G_{ik} = \sigma_A(i) \mu_{ii} = \mu_{ii} < \infty.$$

Consequently  $\sigma$  is a finite invariant measure so  $\pi(j) = \sigma(j)/\sigma(S)$  is a stationary probability and consequently  $X_n$  is stable. Moreover,  $\pi(i) = 1/\mu_{ii}$  and by symmetry this is true for all states  $i \in S$ . By division,  $\pi(j) = \pi(i) {}_A G_{ij} = {}_A G_{ij}/\mu_{ii}$ . ■

**Proof of Proposition 5.56:** By the preceding proof of Theorem 5.21 knowing  $\mu_{ii} < \infty$  means we have a unique strictly positive probability measure  $\pi$  and  $\pi(j) = 1/\mu_{jj}$  for all  $j$ . Since  $\pi(j) > 0$ ,  $\mu_{jj} < \infty$ . ■

### 5.10 Foster’s Criterion for Stability

Theorems 5.21 and 5.44 appear quite general since the existence of a stationary distribution  $\pi$  is a consequence of the theorem, not a hypothesis. On the other hand how can one check that a chain with a countable state space is positive recurrent? Below we review the Liapunov function technique for establishing the stability or positive recurrence of a Markov chain. We won’t have space to investigate the recent developments in the fluid limit approach to stability but an interested reader can consult Dai (1996).

We say a chain  $X_n$  satisfies Foster’s criterion if there exists a finite set  $A$ , a constant  $b < \infty$  and a nonnegative real valued function  $V$  such that

$$\sum_{j \in S} K_{ij} V(j) - V(i) \leq -1 + b \cdot \chi_A(i) \text{ for all } i \in S.$$

**Theorem 5.65** *Let  $X_n$  be an irreducible Markov chain which satisfies Foster’s criterion. Then  $E_i[\tau_A] \leq V(i) + b \cdot \chi_A(i)$  where  $\tau_A$  is the return time to  $A$ .*

Apply Dynkin’s formula to the sequence  $Z_k = V(X_k)$ . Consequently, for any  $i \in S$  and any  $n \geq 0$ ,

$$E_i Z_{\tau_A \wedge n} = E Z_0 + E_i \left[ \sum_{k=1}^{N \wedge n} [E_i(Z_k | \mathcal{F}^{\mathcal{A}^{k-1}}) - Z_{k-1}] \right].$$

By the Markov property,

$$\begin{aligned} E_i(Z_k | \mathcal{A}_{k-1}) - Z_{k-1} &= E_i(V(X_k) | X_{k-1}) - V(X_{k-1}) \\ &= \sum_{j \in S} K_{X_{k-1}, j} V(j) - V(X_{k-1}) \\ &= LV(X_{k-1}) \end{aligned}$$

By hypothesis then

$$E_i(Z_k | \mathcal{F}_{k-1} - Z_{k-1}) \leq -1 + b \cdot \chi_A(X_{k-1}).$$

$\chi_A(X_{k-1}) = 0$  for  $2 \leq k \leq \tau_A \wedge n$ . Consequently, summing from  $k = 1$  to  $k = n$ ,

$$E_i(V_{\tau_A \wedge n}) - V(i) \leq E_i[\tau_A \wedge n] + b \cdot \chi_A(i)$$

which means  $E_i[\tau_A \wedge n] \leq V(i) + b \cdot \chi_A(i)$  since  $V$  is nonnegative. Take the limit as  $n \rightarrow \infty$  and use monotone convergence and we get  $E_i[\tau_A] \leq V(i) + b \cdot \chi_A(i)$ . ■

Note that if  $A = \{i\}$  then the existence of a Lyapunov function implies  $X_n$  is positive recurrent.

**Corollary 5.66** *If the hypotheses of Theorem 5.65 hold and if  $A$  is a finite set then  $X_n$  is positive recurrent.*

**Proof:** Since  $A$  is finite there exists an  $M$  such that  $E_k[\tau_A] < M < \infty$  for all  $k \in A$ . Let  $\tau_A^n$  be the time of the  $n^{\text{th}}$  return to  $A$  and let  $Y_n = \tau_A^{n+1} - \tau_A^n$ . By the strong Markov property

$$E_i[Y_n | X_{\tau_A^n} = k] = E_i[\theta_{\tau_A^n} Y_1 | X_{\tau_A^n} = k] = \sum_{k \in S} P_i(X_{\tau_A^n} = k) E_k[Y_1] \leq M$$

since  $E_k[Y_1] = E_k[\tau_A] < M$  for all  $k$ . Hence  $E_i[Y_n | X_{\tau_A^n}] \leq M$ . Let  $J$  be the number of returns to  $A$  until a return occurs at state  $j \in A$ .

$$\begin{aligned} \mu_{jj} &= E_j\left[\sum_{n=1}^J Y_n\right] = E_j\left[\sum_{n=1}^J E[Y_n | X_{\tau_n}]\right] \\ &\leq E_j\left[\sum_{n=1}^J M\right] = M \cdot E_j J. \end{aligned}$$

We have used Dynkin's formula since

$$E\left[E\left(\sum_{n=1}^{k+1} Y_n | \mathcal{F}_{\tau_k}\right) - \sum_{n=1}^k Y_n\right] = E[Y_k | \mathcal{F}_{\tau_k}] = E[Y_n | X_{\tau_n}].$$

Finally the mean time for the process on  $A$  to return to  $j$  is finite by Theorem 5.47 so  $E_j J < \infty$ . We conclude  $\mu_{jj} < \infty$  so the chain is positive recurrent. ■

The above result may be applied to a discrete  $M|M|1$  queue for instance. From Example 5.8 we get

$$\gamma(i) = E[X_{n+1} - X_n | X_n = i] = (1 - q)p - (1 - p)q = p - q < 0 \text{ for all } i > 0.$$

Take  $A = \{0\}$  and let  $V(i) = i/(p - q)$ . We immediately get stability and consequently the existence of a stationary distribution, but in this case we had one already!

**Example 5.67 Drunkard’s walk - (5.60) continued**

The drunkard’s walk on the line is null recurrent. Suppose, on the contrary, that all states are positive recurrent and  $\pi$  is the associated stationary probability measure. Since the recurrence time  $\mu_{jj}$  is the same for all initial states  $j$ , by homogeneity, it follows that  $\pi(j) = 1/\mu_{jj}$  is a constant. This can’t be because there are an infinite number of states and  $\pi$  is supposed to be a stationary *probability* distribution.

**5.11 Exercises**

Exercise 5.1 Consider a probability transition kernel  $K$  on three states: 0,1,2. Let the initial distribution be  $\alpha = (.2, .1, .7)$  and let the probability transition kernel  $K$  be

$$K = \begin{pmatrix} .5 & .3 & .2 \\ .4 & .2 & .4 \\ .3 & .5 & .2 \end{pmatrix}.$$

- a) Compute  $P(X_1 = 2 | X_0 = 1)$ .
- b) Compute  $P(X_{21} = 2 | X_{20} = 1)$ .
- c) Compute  $P(X_3 = 0, X_5 = 2, X_6 = 1 | X_0 = 1)$ .
- d) Compute  $EX_0$ .
- e) Compute  $E(X_0 | X_0 = 1)$ .
- f) Compute  $P(X_1 = 1)$ .
- g) Compute  $EX_1$ .
- h) Compute  $E(X_1 | X_0 = 1)$ .
- i) Compute  $EX_1^2$ .
- j) Compute  $E(X_1^2 | X_0 = 1)$ .
- k) Compute  $Var(X_1 | X_0 = 1)$ .
- l) Compute  $P(X_0 = 1 | X_1 = 2)$ .
- m) Calculate the stationary probability measure associated with  $K$ .
- n) Calculate the mean number of transitions to return to 0.

Exercise 5.2 Consider the Markov chain  $X_n$  in Exercise 5.1. Define  $Y_n = \chi\{X_n \in \{1, 2\}\}$ , that is define  $Y_n$  to be 1 if  $X_n$  is either 1 or 2 and 0 if  $X_n = 0$ . Is  $Y_n$  a Markov chain?

Exercise 5.3 Consider a probability transition kernel  $K$  on four states: a,b,c,d.

$$K = \begin{pmatrix} 0 & 0 & 1/2 & 1/2 \\ 0 & 0 & 1/3 & 2/3 \\ 1/4 & 1/4 & 0 & 1/2 \\ 1/5 & 2/5 & 2/5 & 0 \end{pmatrix}.$$

- Calculate the probability the chain is in state b after 10 transitions, given that after 8 transitions it is in state a.
- Calculate the probability the chain is in state b after 10 transitions, given that after 8 transitions it is in state a or b and that after 6 transitions it was in state c.
- Calculate the stationary probability measure associated with  $P$ .
- Calculate the mean number of transitions to return to a.

Exercise 5.4 Consider a Markov chain  $X_n$  started in state 1 with a kernel

$$K = \begin{pmatrix} 1/3 & 1/3 & 1/3 \\ 0 & 1/2 & 1/2 \\ 1/2 & 1/2 & 0 \end{pmatrix}$$

defined on the states  $\{0, 1, 2\}$  as usual.

- Calculate  $K_{1,2}^2$ .
- Calculate  $P(X_{31} = 2 | X_{30} = 1)$ .
- What is the period of this chain?
- Calculate  $E(X_2 | X_0 = 1)$ .
- Calculate  $P(X_1 = 2 | X_2 = 1)$ .

Exercise 5.5 Establish the Markov property of the chain constructed by the Kolmogorov extension theorem.

Exercise 5.6 Complete the beginning of Theorem 5.59.

Exercise 5.7 Show that a hitting time defined in Definition 5.48 is a stopping time in the sense of Definition 2.28.

Exercise 5.8 Given a finite aperiodic irreducible Markov chain, prove that for some  $n$  all the entries of  $K^n$  are positive.

Exercise 5.9 Show that a drunk astronaut has a nonzero probability of wandering away from his starting point!

Exercise 5.10 For the kernel given in Exercise 5.3 calculate the limiting probability the chain is in state c and the preceding state was a.

Exercise 5.11 Let  $X_n$  be an irreducible recurrent Markov chain with a stationary distribution  $\pi$ . Show that the process  $W_n$  of the  $X_n$  observed when it enters the set  $A$  has a stationary distribution  $\pi(i)/\pi(A)$  for  $i \in A$ .



Exercise 5.12 Consider a probability transition kernel  $K$  on four states: a,b,c,d.

$$K = \begin{pmatrix} 1/4 & 1/4 & 1/4 & 1/4 \\ 0 & 0 & 1/3 & 2/3 \\ 1/4 & 1/4 & 0 & 1/2 \\ 1/5 & 2/5 & 2/5 & 0 \end{pmatrix}.$$

Let  $F = \{a, b\}$  and  $B = \{c, d\}$ . Calculate the  ${}_B G_{ij}$ . Check that the process on  $F$  has a stationary distribution proportional to the stationary distribution of  $K$  restricted to  $F$ .

Exercise 5.13 Calculate the mean number of customers in a steady state  $M|G|1$  system. Calculate the mean number queued.

Exercise 5.14 Show that the mean system time  $t_q$  ( $W$  in seconds) in a steady state  $M|G|1$  queue satisfies  $q_{av} = pt_q$  (or  $L = \lambda W$  in seconds). This is called Little's Law.

Exercise 5.15 The (s,S) ordering policy is a common stock management technique which strikes a balance between having too much stock on hand and being unable to meet customer demand. Suppose daily demand for cans of soup are independent and equal to  $k$  cans with probability  $p_k$ . At the end of each day, stock is taken and if the stock is less than  $s$  cans we order enough to bring the level up to  $S$  cans; otherwise we do nothing. Delivery takes place before the store opens the next day, but unmet demand during the day is lost. Show that  $X_n$ , the inventory level at the end of the  $n^{th}$  day, is a Markov chain and compute the transition kernel.

Exercise 5.16 Consider a probability transition kernel  $K$  on three states: 0,1,2. Let the initial distribution be  $\alpha = (.4, .1, .5)$  and let the probability transition kernel  $K$  be

$$K = \begin{pmatrix} .4 & .5 & .1 \\ .3 & .2 & .5 \\ .5 & .5 & 0 \end{pmatrix}.$$

- Compute  $P(X_{23} = 0, X_{25} = 2, X_{26} = 1 | X_{20} = 0)$ .
- Compute  $E(|X_1 - 2| | X_0 = 1)$ .
- Compute  $EX_1^2$ .
- Calculate the stationary probability measure associated with  $K$ .
- You receive a 10 dollars every time the chain is in state one, 25 dollars every time the chain is in state two and nothing in state 0. Calculate the long run average amount of money received per transition.
- If the chain starts in state 0, what is the expected number of transitions until the chain reach state 2.
- If the chain starts in state 0, what is the probability it has not reached state 2 by  $n$  transitions
- Calculate  $\sigma(0) = \lim_{n \rightarrow \infty} P(X_n = 0 | X_k \neq 2, k = 1, \dots, n, X_0 = 0)$  and  $\sigma(1) =$

$\lim_{n \rightarrow \infty} P(X_n = 1 | X_k \neq 2, k = 1, \dots, n, X_0 = 0)$  and  $\lim_{n \rightarrow \infty} P(X_n = 0 | X_k \neq 2, k = 1, \dots, n, X_0 = 1)$  and  $\lim_{n \rightarrow \infty} P(X_n = 1 | X_k \neq 2, k = 1, \dots, n, X_0 = 1)$ .

i)  $(\sigma(0), \sigma(0))$  is called the quasistationary distribution. How do you interpret the results in h)?

**Exercise 5.17** A machine tool takes a machine cycle of exactly 45 seconds to load and drill a hole in a particular part. When the machine tool is properly adjusted the holes are drilled perfectly but there is a 2% chance that the machine tool will become misaligned when a part is loaded into place before drilling. When the machine is misaligned it stays misaligned for this and the following cycles and there is a one in 5 chance that the drill hole will be off center. All the holes are automatically scanned for proper positioning so as soon one drill hole is off center the machine is taken off-line and the operator realigns the machine. The realignment takes 6 minutes. During the realignment phase no drilling takes place.

- Model the above production process as a Markov chain. Write down the state space and the transition kernel.
- Calculate the steady state of this Markov chain.
- What is the long run proportion of defective parts produced?
- What is the long run average number of nondefective parts drilled every hour.

**Exercise 5.18** A special IC is produced one at a time by the firing of the silicon wafer in an oven. There are two production regimes, fast firing and slow firing. Fast firing takes 2 hours while slow firing takes 5 hours. If the components of the wafer have the right composition only 5% of the IC's are defective on average at the normal fast firing temperature. If the components are contaminated in some way on average 20% of the IC's are defectives. If the components of the wafer have the right composition on average 1% of the wafers are defective in the slow firing regime. If the components are contaminated there is still an average of 20% defectives produced in the slow firing regime.

Each IC is tested and defective ICs are discarded. Production continues 24 hours a day every day. The following quality control scheme is followed.

- Start with the normal fast firing temperature.
  - If a defective is found the oven is switched to a slow firing temperature.
  - If the next 3 IC's are nondefective then the oven is switched back to fast firing but if a defective is found the quality control engineers stop production and replace the components to eliminate contamination. This repair regime takes 3 hours.
  - When the engineers are finished they start up production at the slow firing temperature.
- Give the state space of a Markov chain describing the transitions between the various operating regimes *if the components remain uncontaminated*. (Hint: don't model the time between transitions.) Give the corresponding transition kernel  $K$ .
  - Calculate the steady state of the above kernel.
  - Calculate the long run average number of hours per transition of the kernel  $K$

(Hint: Consider the time between each transition as a reward; i.e. the reward in the fast firing state is 2 hours while the reward in the repair state is 3 hours.)

- d) Calculate the long run proportion of time spent in the fast firing regime.
- e) Calculate the long run proportion of defective IC's produced.
- f) Assuming we start of in the slow firing regime calculate the on-target ARL, that is the mean number of IC's produced until a false alarm when the repair team replaces the components (uselessly) (just show how to perform the calculation but don't carry it out).
- g) Assuming we are in the fast firing regime when *the components become contaminated* calculate the off-target ARL, that is the mean number of IC's produced until an alarm (just show how to perform the calculation but don't carry it out).

**Exercise 5.19** A piece of production machinery is inspected after 100 hours of production. The inspection takes an hour. About 20% of the inspections find a defect that requires the machine to be repaired immediately. The repair period takes 1,2 or 3 hours with equal probability. After a repair the machine restarts the production cycle. If no defect is found during the inspection period then production resumes immediately.

- a) Model the evolution of the production machinery as a Markov chain Write down the state space and the transition kernel.
- b) Calculate the steady state of this Markov chain.
- c) What is the long run proportion of time the machine is in the inspection phase.

**Exercise 5.20** Every 10 minutes a controller decides whether or not to select a sample from the production line for inspection. The decision to select the sample is taken randomly with probability 10%. Selected samples are stored in a queue until they are inspected. The quality control engineer takes either 10, 20 or 30 minutes with equal probability to do the inspection. He works as long as there are samples to be inspected.

- a) What is the long run proportion of time the quality control engineer is idle.
- b) Can you write down an expression for determining the steady state distribution of the number of samples in the queue (including the one being inspected).

**Exercise 5.21** Show that there are no null recurrent states in a finite Markov chain; that is show the expected return time to any state is either infinite and the state is transient or the expected return time is finite and the state is (positive) recurrent.

**Exercise 5.22** Suppose  $K_{ij} > 0$ , and let  $\tau$  be the exit time from state  $i$ :

$$\tau = \inf\{n \geq 1 : X_n \neq i\}.$$

Show that  $\tau$  has a geometric distribution with respect to  $P_i$ .

**Exercise 5.23** Consider a gambling game where a player has probability  $p$  of winning a dollar and probability  $q = 1 - p$  of losing one. Suppose the initial fortune

of the player is  $i$  dollars and he (or she) plays either until he (or she) is ruined or until he (or she) has earned  $U$  dollars which is enough to buy a plane ticket home. Calculate the probability of ruin. It is best to define a function  $R(i)$  to be the probability of ruin starting with  $i$  dollars. Write a recursion relation for  $R(i)$  and then show this relation is satisfied if

$$R(i) = \frac{1 - (q/p)^i}{1 - (q/p)^U} \text{ if } p \neq 1/2.$$

The fortune of the player can be described as a Markov chain. Give the transition probabilities and phrase the above absorption problem in terms of matrix multiplication.

**Exercise 5.24** Calculate the expected number of games described in Exercise 5.23 the player will play.

**Exercise 5.25** Consider a sequence of independent, positive, integer valued random variables  $\{X_1, X_2, X_3, \dots\}$  with common distribution  $F$  and common p.m.f.  $f$ . Consider the  $\{X_1, X_2, X_3, \dots\}$  to be the interarrival times of a point process  $\{0, S_1, S_2, \dots\}$  where  $S_n = \sum_{i=1}^n X_i$ . Define the age at integer time  $t$  for the point process to be:  $Z(t) := t - S_{n-1}$  if  $S_{n-1} \leq t < S_n$ .  $Z(t)$  represents the time since the last arrival before time  $t$ .

- Show that  $Z(t)$  is a Markov chain with state space  $\{0, 1, 2, \dots\}$ .
- Give the transition matrix.
- Calculate the stationary distribution. Remember that

$$\mu_X = EX_1 = \sum_{y=0}^{\infty} (1 - F(y)).$$

**Exercise 5.26** Show that the sequential ranks of a sequence of i.i.d. random variables  $X_n$ , having a continuous distribution function  $F$ , are independent and that the distribution of  $R_i$  is uniform on the integers  $1, 2, \dots, i$ .

**Exercise 5.27** Write a *Mathematica* program to calculate the approximate average on-target run length for the nonparametric cusum procedure. Use the fact that the observations  $U_i$  are essentially independent uniforms.

**Exercise 5.28** Consider the transition kernel  $K$  given in Example 5.31.

- Write a simulation for a Markov chain with this transition kernel. Let the simulation run for 1000 transitions. Compare the proportion of time spent in the three states with the stationary distribution  $\pi$ .
- Calculate the proportion of transitions which go from  $i$  to  $j$  for each pair of states. Compare this with  $\pi(i)K_{ij}$ .
- For each pair of states  $i$  and  $j$  compare the results in b) with the proportion of transitions which go from  $j$  to  $i$ .

## Chapter 6

# Renewal Theory

### 6.1 Introduction

In this chapter, as in Chapter 4, we start with a simple point process  $\{T_n\}_{n=-\infty}^{\infty}$ ; that is a strictly increasing sequence of random variables such that  $T_0 \leq 0 < T_1$ . The interarrival or sojourn times relative to 0 are denoted:

$$X_n = \begin{cases} T_n - T_{n-1} & n \geq 2 \\ T_1 & n = 1 \\ -T_0 & n = 0 \\ T_{n+1} - T_n & n \leq -1. \end{cases}$$

*As in Chapter 4 we assume that  $T_n$ 's cannot be measured more precisely than integer multiples of some time unit which might be nanoseconds. However, since every measurement in this chapter (except in Section 6.5) is in units we may as well just assume our measurements are integer valued and we suppress the  $\hat{\cdot}$  notation. A value measured in units may be written with brackets when confusion is possible; hence [1] means one nanosecond unit. Functions and processes like  $f_n[x]$  and  $N[t]$  below have square brackets to emphasize that they are defined only at nanosecond units and  $x$  and  $t$  are assumed to be measured in nanosecond units.*

**Definition 6.1** A simple point process,  $\{T_n\}$ , is called a renewal process if the increments  $\{T_n - T_{n-1}\}_{n=-\infty}^{\infty}$  are independent, strictly positive, unit-valued random variables and  $T_0 = 0$ . The point process is called a delayed renewal process if  $T_0 \leq 0$ . We denote the distribution of  $X_n$  by  $F_n$  having p.m.f.  $f_n$  and mean  $\mu_n$ . Note that  $f_n[0] = 0$ .

Many complicated stochastic processes have the structure of a renewal process embedded in them. At the renewal times  $T_n$ , these processes regenerate and the future is stochastically independent of the past. Such would be the case in a machine repair model. Each time the machine is reset the process starts afresh, independent of the past.

Let us define the number of renewals up to and including time  $t$ :

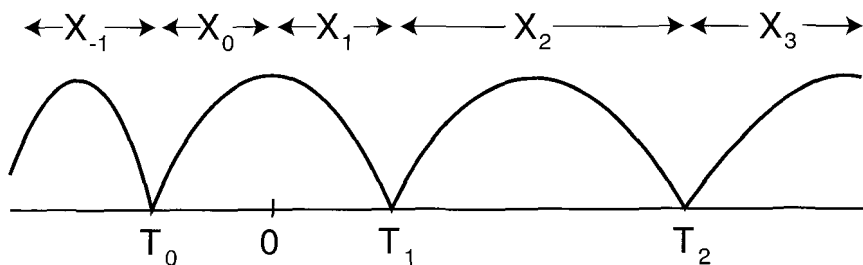

Fig. 6.1 A trajectory of the renewal process.

**Definition 6.2** Let

$$N[t] := \sup \{n : T_n \leq t\}.$$

The counting process  $N[t]$  is called a renewal counting process or often simply the renewal process thereby confounding it with  $\{T_n\}$ .

Since we are assuming the interarrival times  $\{X_n\}$  are strictly positive and hence always greater than or equal to  $[1]$ , it follows that  $N[t] \leq t/[1] < \infty$  for  $t$  fixed. In fact we can give the distribution of  $N[t]$  as follows. Clearly if there are  $n$  or more renewals at time  $t$  then the  $n^{\text{th}}$  renewal occurs before or at time  $t$ . In symbols

$$N[t] \geq n \Leftrightarrow T_n \leq t.$$

Consequently,

$$P(N[t] \geq n) = P(T_n \leq t) \tag{6.1}$$

and

$$\begin{aligned} P(N[t] = n) &= P(N[t] \geq n) - P(N[t] \geq n + 1) \\ &= P(T_n \leq t) - P(T_{n+1} \leq t). \end{aligned}$$

Denote the distribution function of  $T_n$  by  $H_n$ . Since the interarrival times are independent it follows that  $H_n$  may be calculated (by convolution) from the distributions  $\{F_k\}$  of the  $\{X_k\}$ . Consequently,  $P(N[t] = n) = H_n[t] - H_{n+1}[t]$ . We can, moreover, use Exercise 2.13 and (6.1) to calculate  $EN[t]$ :

$$\begin{aligned} EN[t] &= \sum_{n=1}^{\infty} P(N[t] \geq n) \\ &= \sum_{n=1}^{\infty} H_n[t] \end{aligned}$$

This expectation is of course finite since  $N[t]$  is bounded by  $t/[1]$ .

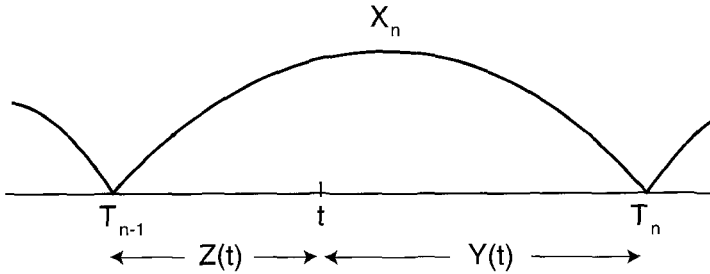

Fig. 6.2 The age and excess at time  $t$ .

**Definition 6.3** Define the age at  $t$ , to be

$$Z[t] = t - T_{n-1} \text{ when } T_{n-1} \leq t < T_n$$

and define the excess at  $t$  to be

$$Y[t] = T_n - t \text{ when } T_{n-1} \leq t < T_n.$$

**Definition 6.4** A process  $\{V[t]\}$  is a regenerative process with embedded (delayed) renewal process  $\{T_n\}$  if

$$V[t] = \sum_{n=1}^{\infty} V^n[Z[t]] \cdot \chi\{T_{n-1} \leq t < T_n\},$$

where  $\{V^n[s] : 0 \leq n < \infty\}$  is a sequence of stochastic processes defined at each time unit  $s \geq 0$ , such that  $\{T_n - T_{n-1}, V^n\}_{n=1}^{\infty}$  forms an independent sequence. The process  $V^n[s]$  is called the  $n^{\text{th}}$  cycle of the regenerative process and is of duration  $T_n - T_{n-1}$ .

We say a regenerative process is homogeneous if all the cycles after the first are identically distributed. These cycles have the same distribution as the canonical cycle  $(X^*, V^*)$ .

Intuitively, the process  $V$  is simply the sequence of independent processes  $V^n$  stuck end to end. At time  $t$ , first determine the cycle, i.e.  $T_{n-1} \leq t < T_n$ , then the age of that cycle at time  $t$ , i.e.  $Z[t]$ , and finally the state of that cycle at time  $t$ , i.e.  $V^n[Z[t]]$ .

**Proposition 6.5** *If  $V[t]$  is a regenerative process then*

$$P(V[t] \in A | Z[t] = x, N[t] = n - 1) = P(V^n[x] \in A | X_n > x).$$

**Proof:**

$$\begin{aligned} P(V[t] \in A | Z[t] = x, N[t] = n - 1) \\ &= P(V^n[x] \in A | T_{n-1} = t - x, X_n > x) \\ &= P(V^n[x] \in A | X_n > x) \end{aligned}$$

■

**Example 6.6 Alternating renewal processes**

Imagine that when a machine breaks down we pick out a new machine from a series of different models; the  $n^{\text{th}}$  having a lifetime  $\{U_n\}$  with mean  $\mu_n$ . Suppose, moreover, the replacement period of the  $n^{\text{th}}$  machine is a random time,  $R_n$  having mean  $r_n$  ( $R_n$  may depend on  $U_n$  – if the machine breaks in some spectacular way it may take longer to replace!). In this case let

$$V^n[s] = \begin{cases} 1 & \text{if } 0 \leq s \leq U_n \\ 0 & \text{if } U_n < s < U_n + R_n \end{cases}$$

and let

$$X_n = U_n + R_n, T_0 = 0 \text{ and } T_n = \sum_{k=1}^n X_k \text{ for } n \geq 1$$

(we do not need to construct the past of this process). Let  $V[t]$  be as in Definition 6.4. Then if  $T_{n-1} \leq t < T_n$ , we are on our  $n^{\text{th}}$  generation and, moreover,

$$V[t] \equiv V^n[t - T_{n-1}] = \begin{cases} 1 & \text{if the } n^{\text{th}} \text{ machine is working at time } t \\ 0 & \text{if not.} \end{cases}$$

Hence  $V[t]$  is 1 if a machine is working at time  $t$  and 0 if a machine is being replaced at time  $t$ .

---

**Example 6.7 Continuous sampling inspection – (3.26) continued**

The continuous inspection procedure developed by Dodge may be analyzed as a renewal process. It is clear that every time the process reverts to tight inspection the entire past is forgotten and a new cycle starts.

---

**Example 6.8 Markov Chains**

The most familiar example of a regenerative process is a recurrent Markov chain. Consider an irreducible, recurrent Markov chain  $M_n$  and denote the time of the  $n^{\text{th}}$  visit to state  $i$  by  $T_n$ . Let the interarrival times between return  $n - 1$  and the return  $n$  to  $i$  be denoted by  $X_n$ ; that is  $X_n := T_n - T_{n-1}$ .



**Lemma 6.9** *The sojourn times  $X_n$ ,  $n = 1, 2, \dots$ , are independent and, moreover,  $X_n$ ,  $n = 2, 3, \dots$ , are identically distributed with p.m.f.  $f_{ii}$ , the interarrival distribution of state  $i$ .*

This is intuitively obvious from the Markov property. Whenever the chain returns to the state  $i$ , all the past is forgotten except  $i$ ; that is the previous interarrival times are forgotten and don't influence the future evolution of the process or, in particular, the future interarrival times.

**Proof:** We start by considering atomic events

$$\begin{aligned} &P(X_1 = w_1, X_2 = w_2, \dots, X_n = w_n, X_{n+1} = w_{n+1}) \\ &= P(X_{n+1} = w_{n+1} | X_1 = w_1, X_2 = w_2, \dots, X_n = w_n) \\ &\quad \cdot P(X_1 = w_1, X_2 = w_2, \dots, X_n = w_n). \end{aligned}$$

Now if we let  $t_k := w_1 + w_2 + \dots + w_k$  for all  $k$  then  $t_k$  is the value of the stopping time  $T_k$ . The event  $\{X_1 = w_1, X_2 = w_2, \dots, X_n = w_n\}$  is in  $\mathcal{F}_{T_n}$  and on this event  $T_n = t_n$  and  $M_{T_n} = i$ . Hence, by the strong Markov property,

$$\begin{aligned} &P(X_{n+1} = w_{n+1} | X_1 = w_1, X_2 = w_2, \dots, X_n = w_n, M_{t_n} = i) \\ &= P_i(X_1 = w_{n+1}). \end{aligned}$$

Now by induction we can get

$$\begin{aligned} &P(X_1 = w_1, X_2 = w_2, \dots, X_n = w_n) \\ &= P_i(X_1 = w_n)P_i(X_1 = w_{n-1}) \cdots P_i(X_1 = w_2)P(X_1 = w_1). \end{aligned}$$

We conclude that the  $W$ 's are independent and for  $n \geq 2$

$$P(X_n = w) = P_i(X_1 = w) = f_{ii}(w).$$

■

## 6.2 Renewal Reward Processes

**Definition 6.10** We say a renewal process  $\{T_n\}$  is a homogeneous renewal process with p.m.f.  $f$  if  $\{X_n\}$  are identically distributed for  $n = 2, 3, \dots$  with p.m.f.  $f$  and mean  $\mu$ .

Throughout this section we assume  $\{T_n\}$  is a homogeneous renewal process.

We can use the law of large numbers to see how fast  $N[t]$  goes to infinity as  $t \rightarrow \infty$ . First we must show  $N[t]$  does indeed tend to infinity with  $t$ . If not, there is an  $n < \infty$  such that  $N[t] < n$  for all  $t$  with positive probability. This follows since

$$\{N[\infty] < \infty\} = \cup_{n=1}^{\infty} \{N[t] < n \text{ for all } t\},$$

so if  $P(N[\infty] < \infty) > 0$  at least one of  $P(N[t] < n \text{ for all } t) > 0$ . However, for any fixed  $s$ ,

$$P(N[t] < n \text{ for all } t) \leq P(N[s] < n) = 1 - H_n[s]$$

by (6.1) and this later expression tends to 0 as  $s \rightarrow \infty$ . We conclude that  $P(N[\infty] < \infty) = 0$ .

**Proposition 6.11** *For homogeneous renewal processes*

$$\lim_{t \rightarrow \infty} \frac{N[t]}{t} = \frac{1}{\mu}$$

with probability 1.

**Proof:** From the definition of  $N[t]$  we have  $T_{N[t]} \leq t < T_{N[t]+1}$  so

$$\frac{T_{N[t]}}{N[t]} \leq \frac{t}{N[t]} < \frac{T_{N[t]+1}}{N[t]}.$$

Now since

$$\frac{1}{n} T_n = \frac{1}{n} X_1 + \frac{1}{n} \sum_{k=2}^n X_k = \frac{1}{n} X_1 + \frac{n-1}{n} \frac{1}{n-1} \sum_{k=2}^n X_k$$

and since  $\{X_n\}$  are i.i.d. for  $n = 2, 3, \dots$  with common mean  $\mu$ , it follows by the law of large numbers that  $T_n/n \rightarrow \mu$  with probability 1. Now the sequence  $N[t]$  as  $t \rightarrow \infty$  is just another way of going to infinity so

$$\frac{T_{N[t]}}{N[t]} \rightarrow \mu \text{ as } t \rightarrow \infty.$$

Also if we write

$$\frac{T_{N[t]+1}}{N[t]} = \frac{T_{N[t]+1}}{N[t]+1} \frac{N[t]+1}{N[t]},$$

we have by the same reasoning

$$\frac{T_{N[t]+1}}{N[t]} \rightarrow \mu \text{ as } t \rightarrow \infty.$$

The proof now follows since  $t/N[t]$  is caught above and below by  $\mu$  as  $t \rightarrow \infty$ . ■

The conclusion of the preceding proposition is quite natural. If the mean inter-arrival time is  $\mu$  it stands to reason that the number of renewals up to time  $t$  should be roughly  $t/\mu$ . We call  $1/\mu$  the rate of the renewal process.

**Proposition 6.12** *If  $\{T_n\}$  is a homogeneous renewal process having p.m.f.  $f$ , mean  $\mu < \infty$  then*

$$\lim_{t \rightarrow \infty} \frac{1}{t} EN[t] = \frac{1}{\mu}.$$

**Proof:** Since  $X_i \geq [1]$  it follows that  $N[t] \leq t$  so  $N[t]/t \leq 1$  and by Proposition 6.11,  $N[t]/t \rightarrow \mu^{-1}$ . The result now follows by the Dominated Convergence Theorem 9.7. ■

Consider a homogeneous renewal process  $\{T_n\}$  and imagine that each generation has an associated reward and that the reward associated with the  $n^{\text{th}}$  generation is  $R^n$ . We assume  $\{T_n - T_{n-1}, R^n\}_{n=2}^\infty$  forms an independent sequence, each pair of which has the same distribution as a canonical generation  $\{X^*, R^*\}$ . This means the rate of reward restarts in an independent and identically distributed fashion at every renewal time (the first renewal period may be different).

Now the average reward for completed cycles by time  $t$  is given by

$$\frac{1}{t} \sum_{n=1}^{N[t]} R^n.$$

The sequence  $\{R^n\}$  is i.i.d. for  $\{n = 2, 3, \dots\}$  so assuming  $E|R^*| < \infty$  the law of large numbers gives

$$\begin{aligned} \frac{1}{t} \sum_{n=1}^{N[t]} R^n &= \frac{N[t]}{t} \frac{\sum_{n=1}^{N[t]} R^n}{N[t]} \\ &\rightarrow \frac{1}{\mu} ER^* \end{aligned}$$

as  $t \rightarrow \infty$ . Finally, we denote by  $\alpha$  the expected reward of the  $n^{\text{th}}$  renewal cycle; that is  $\alpha = ER^*$  since all the cycles after the first are assumed to have the canonical distribution. Hence, the average reward for completed cycles by time  $t$  tends to  $\alpha/\mu$  where  $\mu = EX^*$ .

Let's consider an additive reward structure. Let the rate of return of some reward process be described by a function  $V[t]$  measuring the reward in the time interval  $[t, t + [1])$ . We assume  $V[t]$  is a regenerative process with an embedded renewal process  $\{T_n\}$ . As usual we denote the canonical cycle of  $V[t]$  by  $V^*[s]$  for  $0 \leq s < X^*$ . For the moment we will consider the positive reward  $V^+[t] = \max\{V[t], 0\}$  which is also a regenerative process. Let  $R[t] = \sum_{s=0}^{t-[1]} V[s]^+$  represent the total (positive) reward earned by time  $t$ . Define the reward earned up until time  $z \in [0, T_n - T_{n-1})$  in the  $n^{\text{th}}$  renewal period to be

$$R^n[z] = \sum_{s=T_{n-1}}^{(z+T_{n-1}) \wedge (T_n - [1])} V[s]^+.$$

The reward earned in the complete  $n^{\text{th}}$  renewal period is  $R^n[X_n] \equiv R^n$  and this has the same distribution as the canonical reward  $R^*$  for  $n > 1$ .

Now use the same argument as in Proposition 6.11.

$$\frac{1}{t} \sum_{n=1}^{N[t]} R^n \leq \frac{1}{t} \sum_{s=0}^{t-[1]} V[s] \leq \frac{1}{t} \sum_{n=1}^{N[t]+1} R^n$$

since the rewards are positive. Assuming  $E|R^*| < \infty$  and using the law of large numbers,

$$\frac{1}{t} \sum_{n=1}^{N[t]} R^n \rightarrow \frac{\alpha}{EX^*} \text{ and } \frac{1}{t} \sum_{n=1}^{N[t]+1} R^n \rightarrow \frac{\alpha}{EX^*}$$

where  $\alpha = ER^*$ . We conclude that if  $E|R^*| = E \sum_{s=0}^{X^*-[1]} (V^*)^+[s] < \infty$  then

$$\lim_{t \rightarrow \infty} \frac{1}{t} \sum_{s=0}^{t-[1]} V^+[s] = \frac{1}{\mu} E \sum_{s=0}^{X^*-[1]} (V^*)^+[s].$$

We can now repeat the above argument for the total negative reward process  $V^-[t] = \max\{-V[t], 0\}$ . We conclude that if  $E \sum_{s=0}^{X^*-[1]} (V^*)^-[s] < \infty$  then

$$\lim_{t \rightarrow \infty} \frac{1}{t} \sum_{s=0}^{t-[1]} V^-[s] = \frac{1}{\mu} E \sum_{s=0}^{X^*-[1]} (V^*)^-[s].$$

Since  $V[t] = V^+[t] - V^-[t]$  we may combine these results in the following Theorem.

**Theorem 6.13** *Let  $V[t]$  be a homogeneous regenerative process with canonical cycle  $\{V^*[s]; 0 \leq s < X^*\}$ . Assuming*

$$E \sum_{0 \leq s < X^*} |V^*[s]| < \infty$$

then

$$\lim_{t \rightarrow \infty} \frac{\sum_{s=0}^{t-[1]} V[s]}{t} = \frac{\alpha}{\mu}$$

where  $\alpha = E \sum_{s=0}^{X^*-[1]} V^*[s]$  and  $\mu = EX^*$ .

**Example 6.14 Continuous sampling inspection – (6.7) continued**

We might consider the inspection of an item to yield a (negative) reward of 1. If an item is not inspected the reward is 0. In this case, the long run average reward is precisely the average fraction of items inspected, which was evaluated in Example 3.26.

**Example 6.15 Alternating renewal processes – (6.6) continued**

If we suppose the joint distribution of the machine lifetime and the replacement period  $\{U_n, R_n\}$  are identical for all cycles, then  $V[t]$ , as defined in Example 6.6,

is a regenerative process with a homogeneous embedded renewal process. The preceding theory then applies and we conclude the long run average time spent with the machine working is the mean time the machine works per cycle divided by the mean length of a cycle, that is;

$$\lim_{t \rightarrow \infty} \frac{\sum_{s=0}^t \chi\{V[s] = 1\}}{t} = \frac{\mu}{\mu + r}$$

where  $\mu$  is the common mean lifetime of a machine and  $r$  is the common mean replacement period.

---

**Example 6.16 The discrete  $M|G|1$  queue - (5.29) continued**

The times when a departure leaves the queue empty or when a customer arrives to find a queue empty form embedded renewal processes! This is a consequence of the memorylessness property of the arrival stream. Consequently, if we define  $V[t] = \chi\{X[t] = k\}$ ; i.e. whenever there are exactly  $k$  customers in the queue, we see that  $V[t]$  is a regenerative process. By the above then we know that in the long run, the average time the queue has exactly  $k$  customers waiting tends to  $\alpha(k)$ , the steady state probability the queue has  $k$  customers. Below we show  $\alpha = \pi$  where  $\pi(k)$  is the density was given in (5.29).

Denote the sequence of customer arrival times by  $\{T_n^A; n = 1, \dots, \infty\}$  and denote the sequence of customer departure times by  $\{T_n^D; n = 1, \dots, \infty\}$ . The queue size  $X[T_n^D]$  watched along the sequence  $\{T_n^D; n = 1, \dots, \infty\}$  is a regenerative process because there is an embedded renewal sequence of times when a departure leaves the queue empty. Hence,

$$\lim_{N \rightarrow \infty} \frac{1}{N} \sum_{n=1}^N \chi\{X[T_n^D] < k\} = \Pi(k - 1)$$

where  $\Pi(k - 1)$  is the steady state probability the queue size at service completion times is less than  $k$ . The generating function for  $\pi(k) = \Pi(k) - \Pi(k - 1)$  was given in (5.29). Similarly, if we watch  $\{X[T_n^A - 1]; n = 1, \dots, \infty\}$ , the sequence of queue sizes seen by arriving customers then

$$\lim_{N \rightarrow \infty} \frac{1}{N} \sum_{n=1}^N \chi\{X[T_n^A - 1] < k\} = A(k - 1)$$

where  $A(k - 1)$  is the steady state probability the queue size seen by customer arrivals is less than  $k$ .  $A$  is the cumulative distribution of the queue in steady state at any fixed time by the BASTA property in (5.29); i.e.  $A$  has density  $\alpha$ . Below we show  $A = \Pi$  and we conclude that the distribution of the queue size left behind by service departures is indeed the steady state distribution of the queue.

To show  $A = \Pi$  we first show  $\{X[T_n^D] < k\}$  and  $\{X[T_{n+k}^A - 1] < k\}$  are the same event if the queue is empty at time  $[0]$ ; i.e.  $X[0] = 0$ . Suppose  $X[T_n^D]$ , the number

in the queue after the  $n^{\text{th}}$  departure, is less than  $k$ ; i.e.  $X[T_n^D] < k$ . This means the number of arrivals up to time  $T_n^D$  is less than  $n + k$ . This, in turn, means that  $T_n^D < T_{n+k}^A$  so  $X[T_{n+k}^A - 1] \leq n + k - 1 - n = k - 1$  (because the queue started out empty). On the other hand, if  $X[T_{n+k}^A - 1] < k$  then  $T_n^D < T_{n+k}^A$  and this implies  $X[T_n^D] < k$ . Hence the two events are the same. Finally,

$$\begin{aligned} \Pi(k-1) &= \lim_{N \rightarrow \infty} \frac{1}{N} \sum_{n=1}^N \chi\{X[T_n^D] < k\} \\ &= \lim_{N \rightarrow \infty} \frac{1}{N} \sum_{n=1}^N \chi\{X[T_{n+k}^A - 1] < k\} \\ &= \lim_{N \rightarrow \infty} \frac{1}{N} \sum_{n=1}^{N+k} \chi\{X[T_{n+k}^A - 1] < k\} - \lim_{N \rightarrow \infty} \frac{1}{N} \sum_{n=1}^k \chi\{X[T_n^A - 1] < k\} \\ &= A(k-1). \end{aligned}$$

---

If we can prove a process regenerates then the steady state exists. The idea of regeneration has even been extended to Markov chains on a general state space which have zero probability of recurring to a given point. For coupling on general spaces one can consult the text by Meyn and Tweedie (1993) which describes the splitting technology which creates an artificial atom to force a regeneration.

### 6.3 Stationary Renewal Processes

Consider a simple point process. We now consider the distribution of points around an arbitrary point in time,  $t$ .

**Definition 6.17** Define the interarrival times relative to time  $t$  by

$$X_n[t] = \begin{cases} T_{N[t]+n} - T_{N[t]+n-1} & n \geq 2 \\ Y[t] & n = 1 \\ Z[t] & n = 0 \\ T_{N[t]+n+1} - T_{N[t]+n} & n \leq -1. \end{cases}$$

We say a point process is *stationary* if the distribution of the interarrival times around any time point  $t$  is the same!

It is not at all clear if simple, stationary point processes even exist! The first thing we do then is construct a stationary, homogeneous (necessarily delayed) renewal process.

**Theorem 6.18** *We may construct a stationary renewal process by defining interarrival times by*

$$\begin{aligned} &P(X_{-n} = x_{-n}, \dots, X_{-1} = x_{-1}, X_0 = x_0 \\ &\quad \text{and } X_1 = x_1, X_2 = x_2, \dots, X_n = x_n) \\ &= f[x_{-n}] \cdots f[x_{-1}] \frac{f[x_0 + x_1]}{\mu} f[x_2] \cdots f[x_n] \end{aligned} \quad (6.2)$$

where  $x_{-n}, x_{-n+1}, \dots, x_{-1}, x_0, x_1, x_2, \dots, x_n$  is any sequence of integer valued, non-negative interarrival times.

Of course we have only defined the probability of cylinder sets specified by a finite number of interarrival times, but by the Kolmogorov extension theorem this may be extended to a probability on all the interarrival times.

**Proof:** We show that the distribution of points around an arbitrary point in time  $t$  and around  $[0]$  is the same. Consider the interarrival times measured relative to  $t$  defined in Definition 6.17. Now let  $t = [1]$  and take the case where  $x_0 > 0$

$$\begin{aligned} &P(X_{-n}[1] = x_{-n}, \dots, X_{-1}[1] = x_{-1}, X_0[1] = x_0, \\ &\quad \text{and } X_1[1] = x_1, X_2[1] = x_2, \dots, X_n[1] = x_n) \\ &= P(X_{-n}[0] = x_{-n}, \dots, X_{-1}[0] = x_{-1}, X_0[0] = x_0 - [1], \\ &\quad \text{and } X_1[0] = x_1 + [1], X_2[0] = x_2, \dots, X_n[0] = x_n) \\ &= f[x_{-n}] \cdots f[x_{-1}] \frac{f[x_0 - [1] + x_1 + [1]]}{\mu} f[x_2] \cdots f[x_n] \\ &= P(X_{-n}[0] = x_{-n}, \dots, X_{-1}[0] = x_{-1}, X_0[0] = x_0 \\ &\quad \text{and } X_1[0] = x_1, X_2[0] = x_2, \dots, X_n[0] = x_n). \end{aligned}$$

If on the other hand  $x_0 = 0$ , then

$$\begin{aligned} &P(X_{-n}[1] = x_{-n}, \dots, X_{-1}[1] = x_{-1}, X_0[1] = [0] \\ &\quad \text{and } X_1[1] = x_1, X_2[1] = x_2, \dots, X_n[1] = x_n) \\ &= P(X_{-n+1}[0] = x_{-n}, \dots, X_{-1}[0] = x_{-2}, X_0[0] = x_{-1} - [1] \\ &\quad \text{and } X_1[0] = [1], X_2[0] = x_1, \dots, X_{n+1}[0] = x_n) \\ &= f[x_{-n}] \cdots f[x_{-2}] \frac{f[x_{-1} - [1] + [1]]}{\mu} f[x_1] \cdots f[x_n] \\ &= P(X_{-n}[0] = x_{-n}, \dots, X_{-1}[0] = x_{-1}, X_0[0] = [0] \\ &\quad \text{and } X_1[0] = x_1, X_2[0] = x_2, \dots, X_n[0] = x_n). \end{aligned}$$

We have now shown that the distribution of points around  $[1]$  is the same as around  $[0]$ . Now repeat the argument to show the distribution of points around  $[2]$  is the same as around  $[1]$ . Continuing in this way we see the distribution of points around  $[t]$  is the same as around  $[0]$ . ■

Next remark that by summing out the possible values of the sequence  $x_{-n}, \dots, x_{-1}, x_2, \dots, x_n$ , we get the marginal distribution of  $X_0, X_1$  to be

$$f_{X_0, X_1}(x_0, x_1) = \frac{f[x_0 + x_1]}{\mu}.$$

That this is a joint p.m.f. follows since

$$\sum_{z \geq 0} \sum_{y > 0} f[z + y] = \sum_{z \geq 0} (1 - F[z]) = \mu$$

by Exercise 2.13. Hence, given the the length of the interarrival interval containing 0 is  $\ell$ , the age at 0 is uniformly distributed on  $[0, \ell - 1]$ .

We note that the interarrival times  $\{X_n\}$  for  $n = 2, 3, \dots$  and  $n = -1, -2, \dots$  have common p.m.f.  $f$  (with distribution  $F$ ) and are independent. This follows by summing over all possible values of  $x_0$  and  $x_1$  which gives

$$\begin{aligned} P(X_{-n} = x_{-n}, \dots, X_{-1} = x_{-1}, X_2 = x_2, \dots, X_n = x_n) \\ = f[x_{-n}] \cdots f[x_{-1}] f[x_2] \cdots f[x_n]. \end{aligned}$$

We may extend this probability on the coordinates  $\{X_{-n}, \dots, X_n\}$  to a probability on the infinite sequence by the Kolmogorov extension theorem.

**Definition 6.19** We call the p.m.f.  $e[x] := (1 - F[x])/\mu$  for  $x \geq 0$  the equilibrium distribution for the homogeneous renewal process having distribution  $F$ .

For the stationary renewal process, the distribution of the age at 0,  $Z[0]$ , which by definition is the same as  $X_0$ , has the equilibrium p.m.f.:

$$P(Z[0] = z) = \sum_{y > 0} \frac{f[z + y]}{\mu} = \frac{1 - F[z]}{\mu}$$

for  $z \geq 0$ . This follows by summing out  $x_1$  in the joint p.m.f. of  $X_0, X_1$ . Similarly the excess at 0,  $Y[0]$ , has the same distribution as  $X_1$  which is

$$P(Y[0] = y) = \frac{1 - F[y - [1]]}{\mu}$$

for  $y \geq [1]$ .

Another way of describing the equilibrium renewal process is to write

$$\begin{aligned} P(X_0 = x_0, X_1 = x_1) &= \frac{f[x_0 + x_1]}{1 - F[x_0]} e[x_0] \\ &= P(X = x_0 + x_1 | X > x_0) e[x_0], \end{aligned} \quad (6.3)$$

where  $X$  is a random variable with distribution  $F$ . In practice then, we could simulate an equilibrium renewal process by generating the age at 0,  $Z[0] = X_0$  with the equilibrium p.m.f. and then generating a series of random variables having distribution  $F$ . We pick the first one larger than  $X_0$  to be  $X_0 + X_1$ . By the



above,  $X_0$  and  $X_1$  have the required distribution. The other interarrival times are independent with distribution  $F$ .

It is interesting to note that the renewal period containing 0 has length  $X_0 + X_1$  which does *not* have distribution  $F$ . This follows by calculation:

$$\begin{aligned} P(X_0 + X_1 = x) &= \sum_{k=0}^{x-[1]} P(X_0 = k, X_1 = x - k) \\ &= \sum_{k=0}^{x-[1]} \frac{f[x]}{\mu} \\ &= \frac{xf[x]}{\mu}. \end{aligned}$$

The latter expression is indeed a p.m.f. since  $\sum_{x=1}^{\infty} xf[x] = \mu$  and it is easy to see that  $X_0 + X_1$  is stochastically larger than an interarrival period with distribution  $F$ . This means that for any  $t$  the probability  $X_0 + X_1$  exceeds  $t$  is greater than  $1 - F[t]$ . This follows since

$$\begin{aligned} P(X_0 + X_1 > t) &= \sum_{x>t} \frac{xf[x]}{\mu} \\ &= \frac{(1 - F[t])}{\mu} \sum_{x>t} \frac{xf[x]}{(1 - F[t])} \\ &= \frac{(1 - F[t])}{\mu} E(X|X > t) \\ &\geq 1 - F[t] \end{aligned}$$

where  $X$  is a random variable having p.m.f.  $f$  and we used the fact that  $E(X|X > t) > \mu$  (see Exercise 2.15). This result is related to the renewal paradox discussed in Chapter 4. The condition that the interval  $[T_0, T_1)$  contains 0 makes it different than other intervals. In fact, since a longer interval has a greater probability of containing 0, it follows that  $[T_0, T_1)$  is stochastically larger than an ordinary interarrival period having distribution  $F$ .

**Theorem 6.20** *The stationary point process  $\{T_n\}$  constructed in Theorem 6.18 is the unique stationary point process such that*

$$\begin{aligned} P(X_{-n}[1] = x_{-n}, \dots, X_{-1}[1] = x_{-1}, \\ \text{and } X_1[1] = x_1, X_2[1] = x_2, \dots, X_n[1] = x_n | T_0 = 0) \\ = f[x_{-n}] \cdots f[x_{-1}] f[x_1] \cdots f[x_n] \end{aligned}$$

for all  $n$  and for all possible past and future interarrival times

$$x_{-n}, \dots, x_{-1} \text{ and } x_1, \dots, x_n.$$

In other words there is a unique stationary point process whose Palm measure is that of a homogeneous renewal process with no delay.

In general a simple stationary point process conditioned on having a point at 0 is said to be a Palm process.

**Proof:** Consider any stationary point process  $\{T_n\}$  whose Palm measure is a homogeneous renewal process with no delay. For simplicity we will simply calculate the p.m.f. of interarrival times  $\vec{X} = (X_{-1}, X_0, X_1, X_2)$  since the distribution of an arbitrary number of interarrival times will follow immediately. By hypothesis

$$P(X_{-1} = x_{-1}, X_1 = x_1, X_2 = x_2 | X_0 = 0) = f[x_{-1}]f[x_1]f[x_2],$$

so

$$f_{\vec{X}}[x_{-1}, 0, x_1, x_2] = f[x_{-1}]P(X_0 = 0)f[x_1]f[x_2].$$

Next, if  $x_0 \neq 0$ , we have by stationarity that

$$\begin{aligned} f_{\vec{X}}[x_{-1}, x_0, x_1, x_2] &= P(X_{-1}[1] = x_{-1}, X_0[1] = x_0, X_1[1] = x_1, X_2[1] = x_2) \\ &= P(X_{-1}[0] = x_{-1}, X_0[0] = x_0 - [1], X_1[0] = x_1 + [1], X_2[0] = x_2) \\ &= P(X_{-1} = x_{-1}, X_0 = 0, X_1 = x_0 + x_1, X_2 = x_2) \text{ by iteration} \\ &= f_{\vec{X}}[x_{-1}, 0, x_0 + x_1, x_2] \\ &= f[x_{-1}]P(X_0 = 0)f[x_0 + x_1]f[x_2] \text{ by the above.} \end{aligned}$$

If we now sum the joint p.m.f. on  $x_{-1}, x_0, x_1, x_2$  we conclude that  $1 = \mu \cdot P(X_0 = 0)$ . It follows that

$$P(X_{-1} = x_{-1}, X_0 = x_0, X_1 = x_1, X_2 = x_2) = f[x_{-1}] \frac{f[x_0 + x_1]}{\mu} f[x_2]$$

which is precisely the p.m.f. of the stationary process we constructed. ■

We summarize the results in the following theorem.

**Theorem 6.21** *If  $\{T_n\}$  is a stationary, homogeneous renewal process then for all times  $t$ , the point process  $\{T_{N[t]+n} - t\}$  has the same distribution. In particular the age at  $t$ ,  $Z[t]$  has a fixed p.m.f. - the equilibrium p.m.f.*

**Corollary 6.22** *For a stationary, homogeneous renewal process*

$$EN[t] = \frac{t}{\mu}.$$

**Proof:** For any time  $t$ ,

$$N[t] = \sum_{n=[1]}^t \chi \{Z[n] = 0\}.$$

Hence,

$$EN[t] = \sum_{n=[1]}^t P(Z[n] = 0) = \sum_{n=[1]}^t \frac{1}{\mu} = \frac{t}{\mu}.$$

■

Now consider a stationary regenerative process  $V^e[t]$  with an embedded stationary, homogeneous renewal process  $\{X_n\}$ . To construct such a process consider, as in Definition 6.4, a sequence of independent identically distributed processes. These are the cycles of the regenerative process. Let  $V^*[s]$  be a canonical member of the sequence and let  $X^*$  denote the cycle length of  $V^*[s]$  having distribution  $F$ . Pick  $X_0$  according to the equilibrium p.m.f. and then generate independent cycles having the canonical distribution  $V^*[s]$ , until we find one whose cycle length exceeds  $X_0$ . Denote this cycle by  $V^1$  and denote the cycle length by  $X_0 + X_1$ . The next cycle  $V^2$  is independent with the canonical distribution  $V^*[s]$ . Denote the cycle time by  $X_2$ . Continue in this way for the cycles  $(V^3, X_3), (V^4, X_4), \dots$ . Finally construct  $V^e$  by starting  $V^1$  at time  $T_0 = -X_0$  followed by  $V^2$  started at time  $T_1 = X_1$ ,  $V^3$  started at time  $T_2 = X_1 + X_2$  and so on. By assembling these independent cycles we have built a regenerative process as in Definition 6.4.

The joint p.m.f. of  $(X_0, X_1)$  is

$$P(X_0 = x_0, X_1 = x_1) = e(x_0) \cdot P(X^* = x_0 + x_1 | X^* > x_0) = \frac{f(x_0 + x_1)}{\mu}$$

using (6.3). It is clear the distribution of the pair  $X_0, X_1$  is precisely that of an equilibrium renewal process. Hence the embedded renewal process is stationary and homogeneous.

We remark that this construction relates  $V^e$  to  $V^*$ . In particular we show

**Corollary 6.23** For all  $x \geq 0$  and  $n \geq 1$ ,

$$P(V^e[t] \in A | Z[t] = x, N[t] = n - 1) = P(V^*[x] \in A | X^* > x).$$

**Proof:**  $V^e[t]$  is a homogeneous delayed regenerative process. By Proposition 6.5,

$$\begin{aligned} P(V[t] \in A | Z[t] = x, N[t] = n - 1) &= P(V^n[x] \in A | X_n > x) \\ &= P(V^*[x] \in A | X^* > x) \end{aligned}$$

for  $n \geq 2$ .

If, however,  $N[t] = 0$  then we are still on the first cycle and

$$\begin{aligned}
 & P(V^e[t] \in A | Z[t] = x, N[t] = 0) \\
 &= P(V^e[t] \in A | X_0 = x - t, X_0 + X_1 > x) \\
 &= \frac{P(V^e[t] \in A, X_0 = x - t, X_0 + X_1 > x)}{P(X_0 = x - t, X_0 + X_1 > x)} \\
 &= \frac{P(V^e[t] \in A, X_0 + X_1 > x | X_0 = x - t)}{P(X_0 + X_1 > x | X_0 = x - t)} \\
 &= \frac{P(V^*[x] \in A, X^* > x | X^* > x - t)}{P(X^* > x | X^* > x - t)} \\
 &\quad \text{by the construction of } V^1 \\
 &= P(V^*[x] \in A | X^* > x).
 \end{aligned}$$

We can, moreover, show that such an equilibrium regenerative process is stationary. ■

**Theorem 6.24** *If  $V^e[t]$  is a stationary regenerative process with an embedded, stationary, homogeneous renewal process  $\{T_n\}$  then for any time  $t$  and for any set  $A$*

$$P(V^e[t] \in A) = \frac{E \sum_{0 \leq x < X^*} \chi\{V^*[x] \in A\}}{\mu}.$$

Hence the probability the equilibrium regenerative process is in  $A$  at time  $t$  is the mean time per cycle the canonical process  $V^*[s]$  is in  $A$  divided by the mean length of a canonical cycle.

If  $V^e$  is a real valued regenerative process such that  $E|V^e[0]| < \infty$  then, for any time  $t$ ,

$$EV^e[t] = EV^e[0] = \frac{E \sum_{0 \leq x < X^*} V^*[x]}{\mu}.$$

**Proof:** We condition on  $N[t]$  and the age at  $t$ :

$$\begin{aligned}
 & P(V^e[t] \in A) \\
 &= \sum_{n=1}^{\infty} \sum_{x=0}^{\infty} P(V^e[t] \in A | Z[t] = x, N[t] = n - 1) P(Z[t] = x, N[t] = n - 1) \\
 &= \sum_{n=1}^{\infty} \sum_{x=0}^{\infty} P(V^*[x] \in A | X^* > x) P(Z[t] = x, N[t] = n - 1) \\
 &\quad \text{by Corollary 6.23} \\
 &= \sum_{x=0}^{\infty} P(V^*[x] \in A | X^* > x) P(Z[t] = x).
 \end{aligned}$$

Hence, since the p.m.f. of  $Z[t]$  is  $e$ , the equilibrium p.m.f., we have

$$\begin{aligned} P(V^e[t] \in A) &= \sum_{x=0}^{\infty} P(V^*[x] \in A | X^* > x) e[x] \\ &= \sum_{x=0}^{\infty} \frac{P(V^*[x] \in A, X^* > x) (1 - F[x])}{1 - F[x] \mu} \\ &= \frac{1}{\mu} \sum_{x=0}^{\infty} E\chi \{V^*[x] \in A, x < X^*\} \\ &= \frac{1}{\mu} E \sum_{0 \leq x < X^*} \chi \{V^*[x] \in A\}. \end{aligned}$$

The second result follows from the above by linearity. First establish the result

$$Es(V^e[t]) = \frac{E \sum_{0 \leq x < X^*} s(V^*[x])}{\mu}$$

for simple functions  $s$ . Then using monotone convergence show the result holds for  $(V^e)^+$  and  $(V^e)^-$ , the positive and negative parts of  $V^e$ . Next note that the right hand side is independent of  $t$ , so  $E(V^e[t])^+ = E(V^e[0])^+$  and  $E(V^e[t])^- = E(V^e[0])^-$ . By hypothesis  $V^e[0]$  is integrable so the result holds by linearity. ■

**Corollary 6.25** *Let  $V[t]$  be a real valued regenerative process having identically distributed regenerative cycles where  $\{V^*[s]; 0 \leq s < X^*\}$  denotes a canonical cycle. If  $E|V^e[0]| < \infty$  then*

$$\lim_{t \rightarrow \infty} \frac{\sum_{s=0}^{t-[1]} V[s]}{t} = EV^e[0]$$

where  $V^e$  is the associated stationary regenerative process.

**Proof:** By Theorem 6.24,  $EV^e[0] = E \sum_{0 \leq x < X^*} V^*[x] / \mu$  so the latter is integrable. By Theorem 6.13 then

$$\lim_{t \rightarrow \infty} \frac{\sum_{s=0}^{t-[1]} V[s]}{t} = \frac{\alpha}{\mu}$$

where  $\alpha = E \sum_{0 \leq s < X^*} V^*[s]$  and  $\mu = EX^*$ . Combining these facts gives the result. ■

If  $V[t]$  is a regenerative process then so is  $\{V[t] \in A\}$  where  $A$  is some (measurable) set. Hence the long run average time the regenerative process spends in  $A$ , i.e.  $\lim_{T \rightarrow \infty} T^{-1} \sum_{t=0}^{T-[1]} \chi\{V^e[t] \in A\}$  is equal to the probability a stationary regenerative process is in  $A$  at any time  $t$ , i.e.  $P(V^e[t] \in A) = P(V^e[0] \in A)$ , and this in turn is precisely the mean time the process spends in the set per cycle divided by the mean length of a cycle, i.e.

$$\frac{1}{\mu} E \sum_{0 \leq x < X^*} \chi\{V^*[x] \in A\}.$$

**Example 6.26 Little's Theorem**

Consider a queue  $Q[t]$  with an embedded renewal process  $N[t]$  (for the  $M|G|1$  queue  $N[t]$  would be the number of times the queue empties). The mean arrival rate of the arrival process  $A[t]$  is assumed to be  $\lim_{t \rightarrow \infty} A[t]/t = \lambda$ . Let  $\{W_n\}$  represent the sequence of customer waiting times (including the service and queueing time). Let us make the mild assumption that  $\lim_{n \rightarrow \infty} W_n/n = 0$ .

By Theorem 6.25,

$$\lim_{t \rightarrow \infty} \frac{1}{t} \sum_{s \leq t-1} Q[s] = L$$

where  $L$  is the average queue length. If we stop admitting customers after time  $t$  and we regard the queue size  $Q[s]$  at time  $s$  as a renewal reward process, then the total reward by time  $t$  is the total time spent waiting by customers who arrive by time  $t$ , minus the time to clear the queue which is left over at time  $t$ . If we denote by  $S_k^t$  the service times of the customers remaining at time  $t$  then  $\sum_{s \leq t} Q[s] = \sum_{n=1}^{A[t]} W_n - \sum_{k=1}^{Q[t]} S_k^t$ . Hence,

$$\begin{aligned} \lim_{t \rightarrow \infty} \frac{1}{t} \sum_{s \leq t} Q[s] &= \lim_{t \rightarrow \infty} \frac{1}{t} \left( \sum_{n=1}^{A[t]} W_n - \sum_{k=1}^{Q[t]} S_k^t \right) \\ &= \lim_{t \rightarrow \infty} \left( \frac{N[t]}{t} \frac{1}{N[t]} \sum_{n=1}^{N[t]} W_n - \frac{1}{t} \sum_{k=1}^{Q[t]} S_k^t \right). \end{aligned} \quad (6.4)$$

Remark that  $W_{A[t]}$  is the waiting time of the last customer to arrive before time  $t$ . Hence,  $\sum_{k=1}^{Q[t]} S_k^t \leq W_{A[t]}$  since some of the work has been cleared out between time  $t$  and the time of this last arrival. It follows that

$$\lim_{t \rightarrow \infty} \frac{1}{t} \sum_{k=1}^{Q[t]} S_k^t \leq \lim_{t \rightarrow \infty} \frac{1}{t} W_{A[t]} = \lim_{t \rightarrow \infty} \frac{A[t]}{t} \frac{W_{A[t]}}{A[t]} = 0$$

where we used our assumption that  $\lim_{n \rightarrow \infty} W_n/n = 0$ .

We know the limit of the right side of (6.4) exists and hence so does

$$W := \lim_{m \rightarrow \infty} \frac{1}{m} \sum_{n=1}^m W_n.$$

Moreover,  $L = \lambda W$ .

We conclude that Little's formula holds and  $L = \lambda W$ ; that is, the average queue length equals the product of the average arrival rate and the average waiting time in the queue. This result is very useful in converting the knowledge we already have about the mean queue length of an  $M|G|1$  queue, for example, into knowledge about the average waiting time in the queue. The only thing to check is that  $\lim_{n \rightarrow \infty} W_n/n = 0$ . For an  $M|G|1$  queue this is easy since the waiting time of any

customer is less than the time after he arrives until the queue empties. This is less than the  $(N[t] + 1)^{th}$  cycle length for the  $M|G|1$  queue where  $N[t]$  counts the number of departures which leave behind an empty queue by time  $t$ . If  $X_{N[t]+1}$  denotes this cycle length then  $\lim_{t \rightarrow \infty} X_{N[t]+1}/t = 0$  by the argument in Proposition 6.11.

**Example 6.27 Markov Chains – (6.8) continued**

Consider a transition kernel  $K$  with stationary distribution  $\pi$ . We may construct a stationary Markov chain  $\{M_n; -\infty < n < \infty\}$ . We only need to define the distribution of each cylinder set

$$\begin{aligned} P_\pi(M_{-n} = i_{-n}, M_{[-n+1]} = i_{[-n+1]}, \dots \\ \dots M_{-1} = i_{-1}, M_0 = i_0, \dots, M_n = i_n) \\ = \pi(i_{-n})K_{i_{-n}i_{[-n+1]}} \cdots K_{i_{-1}i_0} \cdots K_{i_{[n-1]}i_n}. \end{aligned}$$

It is easy to check that this definition is consistent so we may construct a measure on doubly infinite sequences using the Kolmogorov extension theorem. By construction, the distribution of  $M_n$  is  $\pi$  for all  $n$ . Now define the point process  $\{T_n; -\infty < n < \infty\}$  of return times to  $j$ . We have seen this is a renewal process with renewal p.m.f.  $f_{jj}$ .

This renewal process is also stationary! To show this we need to calculate the distribution of points around time 0. Let  $F = \{j\}$ . By the construction of  $M_n$

$$\begin{aligned} P(T_0 = -x_0, T_1 = x_1) \\ = P(X_0 = x_0, X_1 = x_1) \\ = P(M_{[-x_0]} = j, M_{[-x_0+1]} \neq j, \dots, M_{-1} \neq j, M_0 \neq j, \dots, M_{x_1} = j) \\ = \pi(j)P(M_{[-x_0+1]} \neq j, \dots, M_{-1} \neq j, M_0 \neq j, \dots, M_{x_1} = j | M_{[-x_0]} = j) \\ = \frac{f_{jj}(x_0 + x_1)}{\mu_{jj}}. \end{aligned}$$

We have therefore shown the distribution of points around time 0 is precisely that of the stationary process since the other interarrival times are i.i.d. with p.m.f.  $f_{jj}$ .

Using Theorem 6.13 we can now prove Proposition 5.20 and its simpler form, Corollary 5.18:

**Proof of Proposition 5.20:** The process  $V[n] := h(M_{n-1}, M_n, U_n)$  was defined iteratively where  $U_n$  has a p.m.f. determined by the states of  $M$  at times  $n - 1$  and  $n$ . This is a regenerative process with embedded renewal process  $T_n$ . The  $(n - 1)^{th}$  cycle ends at some time  $T_{n-1} - 1 = k$  when  $M_k = j$ . Subsequently, for  $0 \leq s < X_n$ ,  $V^n[s] \equiv V[k + 1 + s]$  is determined by the chain  $M_{k+1+s}$  where  $M_k = j$  and the sequence  $U_{k+1+s}$ . Both these sequence  $\{M_{k+1+s}, U_{k+1+s}; s \geq 0\}$  are independent of the past before time  $k$  given  $M_k = j$ . Consequently  $V^n$  is indeed independent of the previous generations so  $V$  is a regenerative process.

Let  $V^e$  be the associated stationary regenerative process. Note that

$$E_{\pi}V^e[0] = \sum_{i,j \in S} \pi(i)K(i,j)Ef(i,j,U_0)$$

and  $E_{\pi}|V^e[0]| = \sum_{i,j \in S} \pi(i)K(i,j)E|f(i,j,U_0)| < \infty$ . Hence by Corollary 6.25

$$\lim_{t \rightarrow \infty} \frac{\sum_{s=0}^t V[s]}{t} = E_{\pi}V^e[0] = \sum_{i,j \in S} \pi(i)K(i,j)E[f(i,j,U_0)|M_0 = i, M_1 = j].$$

■

### Example 6.28 Rare Events - (5.41) continued

We can use renewal theory to give an expression for the mean hitting time of a set of small probability. Let  $\partial F$  denote those points in  $F$  which can be reached from  $B = F^c$  in a single jump. The theory below says that the mean time to hit  $F$  is of the same order as the reciprocal of the stationary measure of  $\partial F$ , i.e.  $\pi(\partial F)$ .

Let  $i_0 \in B = F^c$  and denote by  $f(j)$  the probability the chain  $M$  starting from  $j \in B$  hits  $i_0$  before  $F$ .

**Theorem 6.29** *Let  $R$  be the time to return to  $i_0$  after first hitting  $F$ . Then,*

$$E_{i_0}R = \left( \sum_{i \in F} \pi(i) \sum_{j \in B} K_{ij}f(j) \right)^{-1}.$$

**Proof:** Consider cycles where the chain starts in  $i_0$ , eventually hits  $F$  and then returns to  $i_0$ . These cycles have the same distribution as  $R$  and the same mean  $\mu$ . Now, once per cycle the chain must leave  $F$  for the last time; that is, the chain must jump from  $i \in F$  to  $j \in B$  and then return directly to  $i_0$  without first hitting  $F$  again. Give a reward 1 only when this event occurs. The long run average expected reward is therefore  $1/E_{i_0}R$  since there is one reward per cycle.

On the other hand, consider the reward process

$$V[t] = \{M[t] \in F, M[t+1] \in B, M[t+k] \notin F \text{ for } 1 < k \leq R_t\}$$

where  $R_t$  is the first time after time  $t$  that the chain returns to  $i_0$ . Even though the process at time  $t$  depends on the future after time  $t$ , it does regenerate with a return to  $i_0$ . The long run average expected reward is given by Theorem 6.25:

$$\lim_{t \rightarrow \infty} \frac{\sum_{s=0}^t P(V[s] = 1)}{t} = \sum_{i \in S} \pi(i)P_i(V[0] = 1).$$

If  $i \in F$  and the next jump is to  $B$  and there are no further visits to  $F$  before hitting  $i_0$  then there is a reward. The probability of this is precisely  $\sum_{j \in B} K_{ij}f(j)$ .



Consequently

$$\sum_{i \in S} \pi(i) P_i(V[0] = 1) = \sum_{i \in F} \pi(i) \sum_{j \in B} K_{ij} f(j).$$

Therefore

$$\frac{1}{E_{i_0} R} = \lim_{t \rightarrow \infty} \frac{\sum_{s=0}^t P(\chi\{V[s] = 1\})}{t} = \sum_{i \in F} \pi(i) \sum_{j \in B} K_{ij} f(j)$$

which is the result we want. ■

**Corollary 6.30**

$$\lim_{\pi(F) \rightarrow 0} E_{i_0} \tau = \left( \sum_{i \in F} \pi(i) \sum_{j \in B} K_{ij} f(j) \right)^{-1}.$$

**Proof:** By Proposition 5.42,  $\lim_{\pi(F) \rightarrow 0} E_{i_0} R / \mu_\tau = 1$ . The result now follows from the preceding theorem. ■

One might well ask why the equilibrium regenerative process and its embedded equilibrium renewal process should be studied at all! After all they come about only if we start off a homogeneous regenerative process in a very particular way! The answer is that the distribution of points of any stationary renewal process around a sufficiently large fixed time  $t$  is approximately the same as the distribution of points around  $t$  (or 0) for an equilibrium renewal process. We establish this result in the next section using a coupling argument. This means we may as well assume we are dealing with an equilibrium regenerative process in the first place (at least if the process has been running for some time).

**6.4 Convergence to Stationarity**

Consider two simple point processes  $\{\hat{T}_n\}_{n=-\infty}^\infty$  and  $\{\tilde{T}_n\}_{n=-\infty}^\infty$  defined on the same probability space.

**Definition 6.31** The point processes  $\{\hat{T}_n\}$  and  $\{\tilde{T}_n\}$  are coupled together (at different generations)  $\tau$  and  $\rho$  if with probability one  $\hat{T}_{\tau+n} = \tilde{T}_{\rho+n}$  for  $n = 0, 1, \dots$

**Lemma 6.32** If two point processes  $\{\hat{T}_n\}$  and  $\{\tilde{T}_n\}$  can be coupled together then the distributions of the age at time  $t$ ,  $\hat{Z}[t]$  and  $\tilde{Z}[t]$  respectively, converge. In fact

$$\begin{aligned} & \lim_{t \rightarrow \infty} ||P(\hat{Z}[t] = \cdot) - P(\tilde{Z}[t] = \cdot)|| \\ &= \lim_{t \rightarrow \infty} \sum_{x=0}^\infty |P(\hat{Z}[t] = x) - P(\tilde{Z}[t] = x)| \\ &= 0. \end{aligned}$$

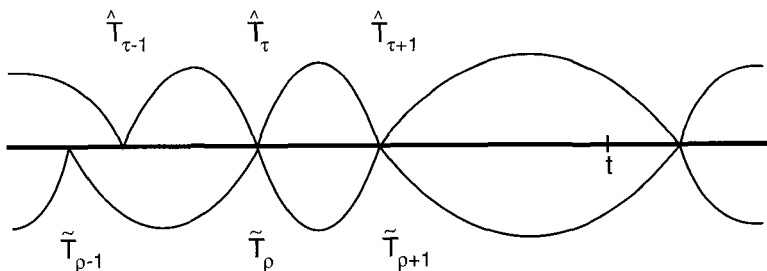
Fig. 6.3 Trajectories coupled before time  $t$ .

**Proof:** Let  $\tau$  and  $\rho$  be the coupling generations. If  $\hat{T}_{\tau} \leq \hat{T}_{\hat{N}[t]}$  where  $\hat{T}_{\hat{N}[t]} \leq t < \hat{T}_{\hat{N}[t]+1}$  then the two point processes have coupled before time  $t$ . Consequently the age back to the last point before  $t$  is the same for both processes! Hence if coupling is successful before time  $t$  then  $\hat{Z}[t] = \tilde{Z}[t]$ . Hence,

$$\begin{aligned}
 & \sum_{x=0}^{\infty} |P(\hat{Z}[t] = x) - P(\tilde{Z}[t] = x)| \\
 & \leq \sum_{x=0}^{\infty} |P(\hat{Z}[t] = x, \hat{T}_{\tau} \leq \hat{T}_{\hat{N}[t]}) - P(\tilde{Z}[t] = x, \tilde{T}_{\rho} \leq \tilde{T}_{\hat{N}[t]})| \\
 & \quad + \sum_{x=0}^{\infty} |P(\hat{Z}[t] = x, \hat{T}_{\tau} > \hat{T}_{\hat{N}[t]}) - P(\tilde{Z}[t] = x, \tilde{T}_{\rho} > \tilde{T}_{\hat{N}[t]})| \\
 & \leq \sum_{x=0}^{\infty} P(\hat{Z}[t] = x, \hat{T}_{\tau} > \hat{T}_{\hat{N}[t]}) + \sum_{x=0}^{\infty} P(\tilde{Z}[t] = x, \tilde{T}_{\rho} > \tilde{T}_{\hat{N}[t]}) \\
 & = P(\hat{T}_{\tau} > \hat{T}_{\hat{N}[t]}) + P(\tilde{T}_{\rho} > \tilde{T}_{\hat{N}[t]}).
 \end{aligned}$$

Now, as  $t \rightarrow \infty$ ,  $\hat{T}_{\hat{N}[t]}$  tends to infinity since  $\hat{N}[t]$  does. Hence  $P(\hat{T}_{\tau} > \hat{T}_{\hat{N}[t]}) \rightarrow 0$  as does  $P(\tilde{T}_{\rho} > \tilde{T}_{\hat{N}[t]})$ . ■

The above argument may be extended to show that if two point processes can be coupled together then in fact the distribution of the last  $n$  points before  $t$  and all those after will asymptotically be the same.

We now proceed to apply this general coupling method to renewal processes. First we note that if the interarrival times are always even multiples of [1] then it would be impossible to couple two trajectories if one started on the even units and one started on the odd units. To avoid this difficulty we make a definition.

**Definition 6.33** We say a random variable  $X$  or its p.m.f.  $f$  has period  $[d]$  if  $d$  is the largest common divisor of the support of  $f$ , i.e. of the set  $\{x : f[x] > 0\}$ .

**Lemma 6.34** Consider two homogeneous renewal processes  $\{T_n\}_{n=1}^\infty$  and  $\{T'_n\}_{n=1}^\infty$  having different delays but the same interarrival p.m.f.  $f$  having period  $[1]$ . There exist two point processes  $\{\hat{T}_n\}_{n=1}^\infty$  and  $\{\tilde{T}_n\}_{n=1}^\infty$  which are equal in distribution to  $\{T_n\}_{n=1}^\infty$  and  $\{T'_n\}_{n=1}^\infty$  respectively, and which are coupled together.

The proof of this proposition is deferred until Section 6.8 so we may see some of the consequences.

**Theorem 6.35** Let  $Z[t]$  and  $Z'[t]$  denote the respective ages at  $t$  of two homogeneous renewal processes  $\{T_n\}$  and  $\{T'_n\}$  having different delays but the same interarrival p.m.f.  $f$  having period  $[1]$ . Then

$$\lim_{t \rightarrow \infty} \|P(Z[t] = \cdot) - P(Z'[t] = \cdot)\| = 0.$$

**Proof:** By Lemma 6.34 we have two processes  $\hat{T}_n$  and  $\tilde{T}_n$  having the same distribution as  $\{T_n\}$  and  $\{T'_n\}$  which are coupled. If  $\hat{Z}[t]$  and  $\tilde{Z}[t]$  are the age processes of  $\hat{T}_n$  and  $\tilde{T}_n$  then  $P(Z[t] = x) = P(\hat{Z}[t] = x)$  and  $P(Z'[t] = x) = P(\tilde{Z}[t] = x)$ . Since

$$\lim_{t \rightarrow \infty} \|P(\hat{Z}[t] = \cdot) - P(\tilde{Z}[t] = \cdot)\| = 0$$

by Lemma 6.32 the result follows. ■

**Theorem 6.36** Consider a homogeneous (possibly delayed) renewal process  $\{T_n\}$  having p.m.f.  $f$ , mean  $\mu < \infty$  and period  $[1]$ . If  $Z[t]$  is the age of  $\{T_n\}$  at  $t$  then

$$\lim_{t \rightarrow \infty} \|P(Z[t] = \cdot) - e[\cdot]\| = 0.$$

**Proof:** Consider the equilibrium renewal process  $\{T'_n\}$  associated with  $\{T_n\}$ . By Proposition 6.35  $\lim_{t \rightarrow \infty} \|P(Z[t] = \cdot) - P(Z'[t] = \cdot)\| = 0$  where  $Z'[t]$  is the age of the equilibrium renewal process at  $t$ . The result now follows from the fact that the distribution of the age at  $t$  for the equilibrium renewal process is precisely  $e$ . ■

**Corollary 6.37 (Feller's renewal theorem)** If  $\{T_n\}$  is a homogeneous (possibly delayed) renewal process having p.m.f.  $f$ , mean  $\mu < \infty$  and period  $[1]$  then the probability of a renewal at  $t$ , that is  $P(T_n = t; \text{ for some } n)$ , as in Figure 6.4, tends to  $1/\mu$  as  $t \rightarrow \infty$ .

**Proof:**

$$\{Z[t] = 0\} = \{T_n = t; \text{ for some } n\}.$$

By Theorem 6.36, however,  $P(Z[t] = 0) \rightarrow e[0] = 1/\mu$  as  $t \rightarrow \infty$ . ■

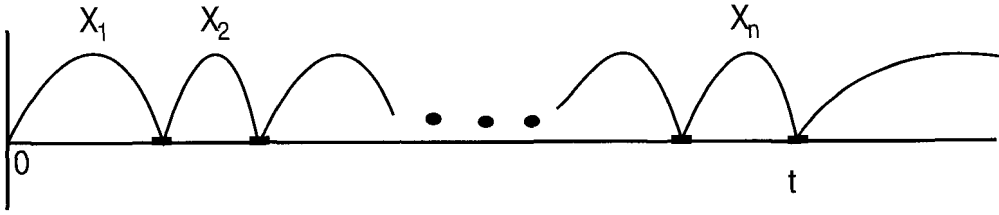
Fig. 6.4 A renewal at time  $t$ .

**Corollary 6.38** If  $\{T_n\}$  is a homogeneous (possibly delayed) renewal process having p.m.f.  $f$ , mean  $\mu < \infty$  and period [1] then

$$\lim_{t \rightarrow \infty} E(N[t + \ell] - N[t]) = \frac{\ell}{\mu}.$$

**Proof:**  $\sum_{x=t+1}^{t+\ell} \chi\{Z[x] = 0\}$  represents the number of renewals in  $(t, t + \ell]$ . Hence

$$E(N[t + \ell] - N[t]) = \sum_{x=t+1}^{t+\ell} E\chi\{Z[x] = 0\} = \sum_{x=t+1}^{t+\ell} P(Z[x] = 0).$$

By Theorem 6.36, however,  $P(Z[x] = 0) \rightarrow 1/\mu$  as  $t \rightarrow \infty$  so the result follows passing the limit through the summation sign. ■

We now prove a somewhat impractical result which completes the above.

**Corollary 6.39** If  $\{T_n\}$  is a homogeneous (possibly delayed) renewal process as in Theorem 6.36 but mean  $\mu = \infty$ , then the probability of a renewal at  $t$  tends to 0 as  $t \rightarrow \infty$ .

The proof is deferred until Section 6.8.

Consider a homogeneous regenerative process  $V[t]$  with embedded homogeneous renewal process  $\{T_n\}$ , having canonical generations  $\{V^*\}$  and canonical cycle length  $X^*$ . Let  $V^e$  denote the corresponding equilibrium regenerative process.

**Corollary 6.40** If  $\{T_n\}$  is a homogeneous (possibly delayed) renewal process having p.m.f.  $f$ , mean  $\mu$  and period [1] then for any set  $A$ ,

$$\lim_{t \rightarrow \infty} P(V[t] \in A) = \frac{1}{\mu} E \sum_{[0] \leq x < X^*} \chi\{V^*[x] \in A\};$$

in other words, the limit is the mean time per canonical cycle that  $V$  is in  $A$  divided by the mean cycle length.

**Proof:** We only give the proof for a renewal process without delay. By Proposition 6.5, for  $n \geq 1$

$$\begin{aligned}
 P(V[t] \in A | Z[t] = x, N[t] = n - 1) \\
 = P(V^n[x] \in A | X_n > x) = P(V^*[x] \in A | X^* > x).
 \end{aligned}$$

Hence, by conditioning on  $Z[t]$  and  $N[t]$ , it follows that

$$\begin{aligned}
 P(V[t] \in A) \\
 &= \sum_{n=1}^{\infty} \sum_{x=0}^{\infty} P(V[t] \in A | Z[t] = x, N[t] = n - 1) P(Z[t] = x, N[t] = n - 1) \\
 &= \sum_{n=1}^{\infty} \sum_{x=0}^{\infty} P(V^*[x] \in A | X^* > x) P(Z[t] = x, N[t] = n - 1) \\
 &= \sum_{x=0}^{\infty} P(V^*[x] \in A | X^* > x) P(Z[t] = x).
 \end{aligned}$$

Hence we have

$$\begin{aligned}
 \lim_{t \rightarrow \infty} P(V[t] \in A) &= \lim_{t \rightarrow \infty} \sum_{x=0}^{\infty} P(V^*[x] \in A | X^* > x) P(Z[t] = x) \\
 &= \sum_{x=0}^{\infty} P(V^*[x] \in A | X^* > x) e[x] \text{ by Theorem 6.36} \\
 &= \sum_{x=0}^{\infty} \frac{P(V^*[x] \in A, X^* > x)}{1 - F[x]} \frac{1 - F[x]}{\mu} \\
 &= \frac{1}{\mu} E \sum_{[0] \leq x < X^*} \chi \{V^*[x] \in A\}.
 \end{aligned}$$

■

Similarly, using Theorem 6.24 we can show

**Corollary 6.41** *Let  $V[t]$  be a real valued regenerative process having identically distributed regenerative cycles where  $\{V^*[s]; 0 \leq s < X^*\}$  denotes a canonical cycle. If  $E|V^e[0]| < \infty$  then*

$$\lim_{t \rightarrow \infty} \frac{\sum_{s=0}^{t-[1]} V[s]}{t} = EV^e[0] = \frac{E \sum_{0 \leq x < X^*} V^*[x]}{\mu}$$

where  $V^e$  is the associated stationary regenerative process.

We have come to the conclusion that after a sufficiently large time  $t$ , the homogeneous regenerative process  $V[t]$  is distributed like the corresponding stationary regenerative process. If, therefore, we can show the existence of an embedded renewal process inside a stochastic process, no matter how complicated, we can

conclude that after a sufficiently long time the process reaches a state of statistical equilibrium. The process continues to fluctuate, of course, but the probability  $V[t] \in A$  is approximately constant and is approximately the long run proportion of time the process spends in  $A$ , which equals the mean time per cycle the process spends in  $A$  divided by the mean length of a cycle.

#### Example 6.42 Markov Chains – (6.27) continued

We have already identified the sequence of return times to a state as a renewal process. We can therefore apply the preceding asymptotic results.

**Theorem 6.43** *If  $M_n, n \geq 0$  is a recurrent, aperiodic Markov chain then*

$$\lim_{n \rightarrow \infty} K_{ij}^n = \frac{1}{\mu_{jj}}$$

where  $\mu_{jj}$  is the mean recurrence time to  $j$ .

**Proof:** If  $\{X_n, n \geq 0\}$  is a recurrent, aperiodic Markov chain, necessarily the chain returns infinitely often to state  $j$  and by Lemma 6.9 these interarrival times are independent and aperiodic. Let  $Z[t]$  denote the age since the last visit to  $j$ .  $Z[t]$  is a regenerative process so for all initial states  $i$ ,

$$\lim_{n \rightarrow \infty} K_{ij}^n = \lim_{n \rightarrow \infty} P(Z[n] = 0 | x_0 = i) = 1/\mu_{jj}$$

where  $\mu_{jj}$  is the mean recurrence time to  $j$ . Here we have used Theorem 6.36 if  $\mu_{jj} < \infty$  and Corollary 6.39 if  $\mu_{jj} = \infty$ . ■

#### Example 6.44 Alternating renewal processes – (6.15) continued

Suppose the joint distribution of the machine lifetime and the replacement period  $\{U_n, R_n\}$  are identical for all cycles as in Example 6.15. The preceding theory then applies and we conclude the probability the machine is working at time  $t$  tends to the long run proportion of time spent with the machine working, which equals the mean time the machine works per cycle divided by the mean length of a cycle. That is,  $\lim_{t \rightarrow \infty} P(V[t] = 1) = \mu/(\mu + r)$  where  $\mu$  is the common mean lifetime of a machine and  $r$  is the common mean replacement period.

#### Example 6.45 The $M|G|\infty$ queue –(4.12) continued

Consider the example of the  $M/G/\infty$  queue discussed in Example 4.12. We saw the times  $\{T_n\}$  when a customer arrives to find a queue empty are an embedded renewal process! Consequently if we define  $V[t] = 1$  whenever there are exactly  $k$  customers in the queue we see that  $V[t]$  is a regenerative process. By the above then we know that as  $t \rightarrow \infty$  the probability there are exactly  $k$  customers in the queue tends to a limit.

## 6.5 Renewal with Nonlattice Variables

We could generalize all the preceding results to real-valued homogeneous renewal processes  $\{T_n^R\}$  having interarrival times  $\{X_n^R\}$  with a common continuous or non-lattice distribution function  $F^R$  having mean  $\mu^R$ . Certainly the proofs of Propositions 6.11 and 6.12 do not depend on the discrete nature of the distributions. We can also define the age  $Z^R(t)$  and excess  $Y^R(t)$  at time  $t$  and we can prove convergence to the renewal equilibrium distribution.

To do this recall the notation that denotes  $t$  seconds converted and rounded up to the nearest nanosecond by  $\hat{t}$  and for the remainder of this section we use the notation developed in Chapter 4. We can define an approximate discrete renewal process by letting  $\{\hat{X}_n\}$  denote the sequence of nanosecond valued interarrival times given by  $\hat{X}_n = [\eta X_n^R]$ . The distribution of these interarrival times is  $F[\hat{x}] = F^R(x)$ . The age of this discrete renewal process is  $\hat{Z}[\hat{t}]$  as defined in Definition 6.3. By Theorem 6.36 the age distribution converges to  $e(\hat{x}) = (1 - F(\hat{x}))/\mu$  as  $t \rightarrow \infty$ . Consequently as  $t \rightarrow \infty$

$$\begin{aligned} P(Z^R(t) \leq z) &\approx P(\hat{Z}[\hat{t}] \leq \hat{z}) \approx \sum_{0 < k \leq \hat{z}} \frac{1 - F[k]}{\mu} \\ &\approx \sum_{0 < k \leq \eta z} \frac{1 - F^R(x/\eta)}{\eta \mu^R} \approx \int_0^z \frac{1 - F^R(s)}{\mu^R} ds. \end{aligned}$$

We conclude that asymptotically the age distribution has a density  $e^R(z) = (1 - F^R(z))/\mu^R$ . There is, however, a nasty complication. Suppose the interarrival times  $[X_n]$  have p.m.f.  $f^R$  given by  $f^R(1) = f^R(\sqrt{2}) = 1/2$ . If we pick a sequence of times  $t$  tending to infinity of the form  $m + n\sqrt{2}$  where  $m$  and  $n$  are integers, it is clear that the age at  $t$  is also of this form. Hence the distribution of the age is stuck on this subgroup of the reals and consequently the age process does not even have a density while the equilibrium measure does. Hence we don't have convergence of densities in a total variation sense (unlike the discrete case). We have, however, sketched how the age converges in distribution to  $e$ .

Bearing in mind this complication we simply state an extension of Corollary 6.40 for general regenerative processes having an embedded renewal sequence which is not concentrated on any sublattice like the nanoseconds.

**Theorem 6.46 (Extension to non-lattice interarrival times)** *If, for some measurable set  $A$ , the function given by  $P(V(s) \in A, s < X^*)$  is Riemann integrable in  $s$  then*

$$\lim_{t \rightarrow \infty} P(V(t) \in A) = \alpha/\mu$$

where  $\mu$  is the mean cycle length and  $\alpha$  is the mean time  $V(s)$  is in  $A$  per cycle;

that is

$$\alpha = E \int_{s=0}^{X^*} \chi\{V(s) \in A\} ds.$$

This result includes the convergence in distribution of the age and the proof is not unlike that sketched above.

## 6.6 Homogeneous Coupling

We now couple homogeneous renewal processes that start out  $[d]$  units apart.

**Proposition 6.47** *Consider a homogeneous renewal process  $\{T_n\}$  such that  $T_0 = 0$  having p.m.f.  $f$ , and period  $[1]$ . We may construct two copies (i.e. having the same distribution)  $\{U_n\}$  and  $\{V_n\}$  such that  $\{U_n\}$  and  $\{V_n + [d]\}$  may be coupled together.*

Note that the coupling may occur a different generations. Consider a p.m.f. with period  $[1]$  that puts probability  $1/2$  at the values  $3$  and  $5$ . Clearly a copy of the renewal process started at  $0$  can't be coupled at the same generation with a copy started at  $[1]$  but if the first copy takes one extra step then they can.

**Proof:** By hypothesis the largest common divisor of the  $\{x : f[x] > 0\}$  is  $1$ . Let  $[d]$  be any unit. From the lemma in the Appendix we have positive integers  $\{p_i\}_{i=1}^{\ell_1}$ ,  $\{n_i\}_{i=1}^{\ell_2}$  and units  $\{x_i\}_{i=1}^{\ell_1}$ ,  $\{y_i\}_{i=1}^{\ell_2}$  from the support of  $f$  such that

$$\sum_{i=1}^{\ell_1} p_i x_i - \sum_{i=1}^{\ell_2} n_i y_i = [d].$$

Define  $n := \sum_{i=1}^{\ell_1} p_i$  and  $m := \sum_{i=1}^{\ell_2} n_i$  and construct a series of blocks for  $b = 1, 2, \dots$  made from a series of i.i.d. random variables with p.m.f.  $f$ :

$$\{X_1(b), X_2(b), \dots, X_m(b); X_{m+1}(b), X_{m+2}(b), \dots, X_{m+n}(b)\}_{b=1}^{\infty}.$$

For good measure we also construct an additional independent sequence  $\{X_k^* : k = 1, 2, \dots\}$  having p.m.f.  $f$ . Define

$$A(b) = \sum_{k=1}^m X_k(b) \text{ and } B(b) = \sum_{k=m+1}^{m+n} X_k(b).$$

It follows that

$$P(A(b)) = \sum_{i=1}^{\ell_1} p_i x_i \geq \prod_{i=1}^{\ell_1} f(x_i)^{p_i} > 0$$



and

$$P(B(b) = \sum_{i=1}^{\ell_2} n_i y_i) \geq \prod_{i=1}^{\ell_2} f(y_i)^{n_i} > 0$$

so  $P(A(b) = B(b) + [d]) > 0$ .

Let  $N = b$  if  $b$  is the first block such that

$$A(b) = \sum_{i=1}^{\ell_1} p_i x_i \text{ and } B(b) = \sum_{i=1}^{\ell_2} n_i y_i.$$

Since the blocks are independent,  $N$  is a geometric random variable and  $P(N < \infty) = 1$ .

To construct the point processes  $\{U_n\}$  and  $\{V_n\}$  define  $U_0 = V_0 = 0$  and define the respective interarrival times

$$\hat{X}_i = \begin{cases} X_k(b) & \text{for } i = k + (b - 1)(m + n) \text{ where} \\ & k = 1, \dots, m + n; b = 1, \dots, N - 1 \\ X_k(N) & \text{for } i = k + (N - 1)(m + n); k = 1, \dots, m \\ X_k^* & \text{for } i = m + k + (N - 1)(m + n); k = 1, 2, \dots \end{cases}$$

Hence in block  $b < N$ ,  $\hat{X}_{(b-1)(n+m)+k} = X_k(b)$  for  $k = 1, 2, \dots, m + n$ ; that is, the  $\hat{X}_i$  just march through the succession of values in each block. In block  $N$  the values of  $\hat{X}_i$  march through the first  $m$  values of the block and

$$\sum_{i=1+(N-1)(m+n)}^{m+(N-1)(m+n)} \hat{X}_i = \sum_{i=1}^{\ell_1} p_i x_i.$$

After that the values of  $\hat{X}_i$  are those of an independent sequence  $X_k^*$ . Note that the distribution of the sequence  $\hat{X}_i$  is *not* conditioned by the value of  $N$  since we switch to the  $X_k^*$  sequence *after*  $N$  is determined.

Next,

$$\tilde{X}_i = \begin{cases} X_{m+k}(b) & \text{for } i = k + (b - 1)(m + n) \text{ where} \\ & k = 1, \dots, n; b = 1, \dots, N \\ X_k(b) & \text{for } i = n + k + (b - 1)(m + n) \text{ where} \\ & k = 1, \dots, m; b = 1, \dots, N - 1 \\ X_k^* & \text{for } i = n + k + (N - 1)(m + n); k = 1, 2, \dots \end{cases}$$

Hence we assign the  $\tilde{X}_i$  in block  $b < N$  according to the following table:

$$\begin{array}{ccccccc} \tilde{X}_{(b-1)(m+n)+1} & \dots & \tilde{X}_{(b-1)(m+n)+n} & \tilde{X}_{(b-1)(m+n)+n+1} & \dots & \tilde{X}_{(b-1)(m+n)+n+m} \\ \downarrow & & \downarrow & \downarrow & & \downarrow \\ X_{m+1}(b) & \dots & X_{m+n}(b) & X_1(b) & \dots & X_m(b) \end{array}$$

Hence for  $b < N$  we first march through the last  $n$  values in block  $b$  and then through the first  $m$ . If  $N = b$  then we still march through the last  $n$  values in block

$N$  and

$$\sum_{i=m+1+(N-1)(m+n)}^{N(m+n)} \tilde{X}_i = \sum_{i=1}^{\ell_2} n_i y_i.$$

After that the values of  $\tilde{X}_i$  are those of an independent sequence  $X_k^*$ . Note that the distribution of the sequence  $\tilde{X}_i$  is *not* conditioned by the value of  $N$  since we switch to the  $X_k^*$  sequence *after*  $N$  is determined.

In fact the above definitions simply make the sum of the interarrivals in a block the same for  $\{U_n\}$  and  $\{V_n\}$  up until we have a success at the  $N^{th}$  block. After that we define the interarrival times to be the same. To recapitulate, for each block  $b$ , we first assign  $\hat{X}_{(b-1)(n+m)+k}; k = 1, \dots, m$  and  $\tilde{X}_{(b-1)(m+n)+k}; k = 1, \dots, n$ . If

$$\sum_{k=1}^m \hat{X}_{(b-1)(n+m)+k} \equiv A(b) = B(b) + [d] \equiv \sum_{k=1}^n \tilde{X}_{(b-1)(m+n)+k} + [d]$$

then we say  $N = b$  and (in a Markovian way) we define future interarrival times to be common, i.e.  $X_k^*$ , so the processes  $U_n$  and  $V_n + [d]$  are coupled thereafter. If  $A(b) \neq B(b) + [d]$  then we complete the assignment in such a way that  $U_{b(m+n)} = V_{b(m+n)}$ ; that is  $U_{b(m+n)}$  and  $V_{b(m+n)} + [d]$  are still  $d$  units apart.

We can define  $\tau = (N - 1) \cdot (n + m) + m$  and  $\rho = (N - 1) \cdot (n + m) + n$ . From the above  $U_\tau = V_\rho + [d]$  so we have achieved our coupling. We do emphasize that the processes constructed are renewal processes with p.m.f.  $f$ , since we have simply put together independent interarrival times. ■

**Proof of Proposition 6.34:** Let  $D = T'_1 - T_1$  and for each value  $D = [d]$  use Proposition 6.47 to construct two copies  $\{U_n\}, \{V_n\}$  of a homogeneous renewal process with  $U_0 = V_0 = 0$  with the same interarrival distribution as  $\{T_n\}$  and  $\{T'_n\}$  such that  $\{U_{\tau_U+k} = V_{\rho_V+k} + [d]\}$  where  $\tau_U$  and  $\rho_V$  are random indices which depend on  $d$ . Since  $D$  is random this means constructing an infinite family of pairs of processes, a pair for each  $D = [d]$ .

Now the point process  $\{T_n\}_{n=1}^\infty$  has the same distribution as  $\{\hat{T}_n := T_1 + U_{n-1}\}_{n=1}^\infty$  since both are homogeneous renewal sequences and  $T_1 = \hat{T}_1$ . Similarly  $\{T'_n\}_{n=1}^\infty$  has the same distribution as  $\{\tilde{T}_n := T'_1 + V_{n-1}\}_{n=1}^\infty$ . Let  $\tau := \tau_U + 1$  and  $\rho := \rho_V + 1$ . However

$$\hat{T}_\tau = T_1 + U_{\tau_U} = T'_1 - D + V_{\rho_V} + D = \tilde{T}_\rho$$

so we have built the required coupling. ■

Closer inspection of Proposition 6.47 reveals the following refinement:

**Proposition 6.48** *If  $1 \leq [\delta] \leq \ell$  are displacements we may construct  $\ell$  renewal processes  $\{V_n^\delta\}$  and a process  $\{U_n\}$  all having the same distribution as  $\{T_n\}$  such that  $\{V_n^\delta + [\delta]; 1 \leq [\delta] \leq \ell\}$  may be all coupled together with  $\{U_n\}$ . That is, there exist stopping times  $\rho^1 < \rho^2 < \dots < \rho^\ell$  and stopping times  $\tau^1 < \tau^2 < \dots < \tau^\ell$  such that for all  $1 \leq [\delta] \leq \ell$ ,  $V_{\rho^\delta+k}^\delta + [\delta] = U_{\tau^\delta+k}$ ,  $k = 0, 1, 2, \dots$*

**Proof:** By Proposition 6.47 with  $d = 1$  we can construct  $\{V_n^1\}$  and  $\{U_n\}$  up to coupling times  $\rho^1$  and  $\tau^1$  respectively. Now define the process  $\{V_n^2\}$  to be equal to  $\{V_n^1\}$  until time  $\rho^1$ . Next repeat the construction in Proposition 6.47. Tack this construction on the end of the processes we have already constructed; that is define  $\{V_n^2\}$  up until time  $\rho^2$  and  $\{U_n\}$  up until  $\tau^2$ . We may also go back and extend the definition of  $\{V_n^1\}$  to equal  $\{U_{\tau^1+n}\}$  for  $\rho^1 < n \leq \tau^2$ . We may continue in this way to complete the construction. ■

**Proof of Corollary 6.39:** Let us suppose the corollary is false so there must exist some  $\epsilon > 0$  and a sequence of  $\{t_j; j = 1, 2, 3, \dots\}$  such that for all  $t_j$  in the sequence,  $P(Z[t_j] = 0) \geq \epsilon$ . Now consider a truncated renewal process  $\{T_n^\alpha\}$  with increments  $X_i^\alpha := \min\{X_i, \alpha\}$ . Since  $\mu = \infty$  we can pick  $\alpha$  large enough so that

$$\mu^\alpha := EX_i^\alpha > 4/\epsilon; i = 2, 3, \dots$$

Denote the number of renewals of the truncated process up to time  $t$  by  $N^\alpha[t]$ . By Proposition 6.12  $\lim_{t \rightarrow \infty} EN^\alpha[t]/t = 1/\mu^\alpha$  so there exists an integer  $\ell$  such that

$$\ell > 1 + 2/\epsilon \text{ and } EN^\alpha[\ell]/\ell < 2/\mu^\alpha < \epsilon/2.$$

By stationarity,  $E(N[t+\ell] - N[t]) \leq EN[\ell] + 1$  and since  $\{T_n^\alpha\}$  is a truncated renewal process it is obvious that  $EN[\ell] + 1 \leq EN^\alpha[\ell] + 1$ . Hence  $E(N[t+\ell] - N[t]) \leq \ell\epsilon/2 + 1$  for all  $t$ .

Assuming, without loss of generality, that  $\{T_n\}$  has 0 delay we may, by Proposition 6.48, construct renewal processes  $\{V_n^\delta; 1 \leq [\delta] \leq \ell\}$  and  $\{U_n\}$  which all have the same distribution as  $\{T_n\}$  such that  $\{V_n^\delta + [\delta]\}$  may be simultaneously coupled with  $\{U_n\}$ . Hence if  $t$  is chosen large enough we can ensure that the probability that all  $\ell$  processes have coupled before time  $t$  is greater than  $1 - \epsilon'$  where  $\epsilon'$  is arbitrarily small; that is  $P(U_{\tau^\ell} > t) \leq \epsilon'$ . Now the probability of renewal by the process  $\{T_n\}$  at  $t + [\delta]$  is the same as the probability of renewal of the process  $\{V_n^\delta\}$  at  $t + [\delta]$ . Let  $\tilde{Z}^\delta$  denote the age process of the point process  $\{V_n^\delta\}$ , while  $\hat{Z}$  denotes the age process for the process  $\{U_n\}$ . Hence

$$E(N[t + \ell] - N[t]) = E \sum_{\delta=1}^{\ell} \chi\{\hat{Z}[t + \delta] = 0\}.$$

However,

$$\begin{aligned}
 & |E(N[t + \ell] - N[t]) - \ell P(Z[t] = 0)| \\
 &= |E \sum_{\delta=1}^{\ell} \chi\{\hat{Z}[t + \delta] = 0\} - \ell P(Z[t] = 0)| \\
 &= |E \sum_{\delta=1}^{\ell} \chi\{\hat{Z}[t + \delta] = 0\} - E \sum_{\delta=1}^{\ell} \chi\{\tilde{Z}^{\delta}[t] = 0\}| \\
 &\leq \sum_{\delta=1}^{\ell} E|\chi\{\hat{Z}[t + \delta] = 0\} - \chi\{\tilde{Z}^{\delta}[t] = 0\}| \\
 &\leq \sum_{\delta=1}^{\ell} E\chi\{\hat{Z}[t + \delta] \neq \tilde{Z}^{\delta}[t]\} \\
 &\leq \ell \cdot P(U_{\tau\epsilon} > t) \leq \ell \cdot \epsilon',
 \end{aligned}$$

using the fact that the ages  $\hat{Z}[t + \delta]$  and  $\tilde{Z}^{\delta}[t]$  are the same for  $\delta = 1, \dots, \ell$  if  $U_{\tau\epsilon}$  is less than  $t$  because  $\{V_n^{\delta}\}$  stays exactly  $\delta$  units behind  $\{U_n\}$  after this time.

Hence if we choose  $t = t_j$  then by hypothesis  $P(\hat{Z}[t_j] = 0) \geq \epsilon$ , so by the above we have  $E(N[t_j + \ell] - N[t_j]) \geq \ell\epsilon - \ell\epsilon'$ . This leads to a contradiction since we have already shown that  $E(N[t + \ell] - N[t]) \leq \ell\epsilon/2 + 1$  for all  $t$  and this would imply  $\ell\epsilon - \ell\epsilon' \leq \ell\epsilon/2 + 1$  or  $\ell \leq (2/\epsilon)/(1 - \epsilon'(2/\epsilon))$ . Since  $\epsilon'$  is arbitrarily small, this contradicts our assumption that  $\ell > 1 + 2/\epsilon$ . We conclude that the sequence  $\{t_j\}$  where  $P(\hat{Z}[t_j] = 0) \geq \epsilon$  cannot exist and it therefore follows that  $P(\hat{Z}[t] = 0) \rightarrow 0$  as  $t \rightarrow \infty$ . ■

## 6.7 The Bernoulli Part and Coupling

Consider the p.m.f.,  $f_X$ , of some unit-valued random variable  $X$ .

### Definition 6.49 (The Bernoulli Part)

$$b(f_X) = \sum_{k=-\infty}^{\infty} \min(f_X[k], f_X[k + 1]).$$

By a slight abuse of notation let  $b(X) = b(f_X)$ . Note that  $0 \leq b(X) \leq 1$ .

### Lemma 6.50 (The Bernoulli Part Decomposition)

There exist random variables  $Y$ ,  $\epsilon$  and  $L$  such that  $X$  and  $Y + \epsilon \cdot L$  have the same distribution where  $Y$  and  $L$  are unit-valued random variables and  $\epsilon$  is integer valued

such that

$$\begin{aligned} L & \text{ is independent of } (Y, \epsilon) \\ P(L = [1]) &= P(L = [0]) = \frac{1}{2} \\ P(\epsilon = 1) &= 1 - P(\epsilon = 0) = b(X). \end{aligned}$$

**Proof:** Assume  $b(X) > 0$ ; otherwise the representation is trivial. Construct independent random variables  $V, U, \epsilon$  and  $L$  such that  $V$  has density

$$f_V[k] = \min(f_X[k], f_X[k+1])/b(X),$$

$U$  has density

$$f_U[k] := \frac{f_X[k] - b(X)(f_V[k] + f_V[k-1])/2}{(1 - b(X))}$$

and such that  $L$  and  $\epsilon$  are Bernoulli random variables as given above. By evaluation we see  $(1 - \epsilon)U + \epsilon(V + L)$  has the same law as  $X$  (see Exercise 6.1). Hence, letting  $(1 - \epsilon)U + \epsilon V = Y$  we have the desired representation. ■

**Theorem 6.51 (The Coupling Theorem)** *If  $\{T_n\}$  is a renewal process such that  $\sum_{n=1}^{\infty} b(X_n) = \infty$  then there exists a renewal process  $\{\hat{T}_n\}$  and a delayed renewal process  $\{\tilde{T}_n\}$  defined on the same probability space such that  $\{\hat{T}_n\}$  is equal in distribution to  $\{T_n\}$  and  $\{\tilde{T}_n\}$  is equal in distribution to  $\{T_n + [1]\}$  and such that  $\{\hat{T}_n\}$  and  $\{\tilde{T}_n\}$  are coupled at the same generation  $\tau$ .*

We defer the proof of this theorem while we discuss its consequences and develop lemmas to be used in the proof.

The Bernoulli part in Lemma 6.50 may be thought of as an extra, independent Bernoulli step hidden inside  $X$ . The condition  $\sum_{n=1}^{\infty} b(X_n) = \infty$  in Theorem 6.51 requires that there be sufficient Bernoulli steps to ensure coupling. Suppose, for example,  $f_X[2] = f_X[3] = f_X[4] = \frac{1}{3}$ . The Bernoulli part is  $b(X) = 2/3$ . A sum  $T_n = \sum_{k=1}^n X_k$  of independent  $X_k$ 's with the same distribution as this  $X$  clearly has a Bernoulli equal to  $\sum_{k=1}^n b(X_k) = 2n/3$ . Theorem 6.51 therefore holds as does Proposition 6.47.

On the other hand suppose  $f_X[2] = f_X[4] = \frac{1}{2}$ . There is no Bernoulli part. A sum  $T_n = \sum_{k=1}^n X_k$  of independent  $X_k$ 's with the same distribution as this  $X$  clearly has no Bernoulli part:  $\sum_{k=1}^n b(X_k) = 0$ . For such a sequence Theorem 6.51 clearly fails as does Proposition 6.47!

When the random variables are not identically distributed we can have an in between case. Suppose the p.m.f of  $X_k$  is  $f_k[2] = \frac{1}{2} - \frac{1}{4^k}$ ,  $f_k[3] = \frac{1}{4^k}$  and  $f_k[4] = \frac{1}{2}$ . In this case  $b(X_n k) = \frac{2}{4^k}$  so  $\sum_{k=1}^n b(X_k) < \infty$  and Theorem 6.51 fails!

Finally if  $f_X[3] = f_X[5] = \frac{1}{2}$  there is no Bernoulli part so Theorem 6.51 fails but the period is [1] so Proposition 6.47 holds. This is not surprising since the Bernoulli part allows two copies of the renewal process to be coupled at the same generation and this is not always possible.

**Corollary 6.52** *If  $\{T_n\}$  is a renewal process such that  $\sum_{n=1}^{\infty} b(X_n) = \infty$  then*

$$\lim_{t \rightarrow \infty} \sum_{n=1}^{\infty} |P(T_n = t) - P(T_n + [1] = t)| = 0.$$

**Proof:** We use Theorem 6.51 to construct a renewal process  $\{\hat{T}_n\}$  equal in distribution to  $\{T_n\}$  and a delayed renewal process  $\{\tilde{T}_n\}$  which is equal in distribution to  $\{T_n + [1]\}$ . Hence

$$\begin{aligned} & \sum_{n=1}^{\infty} |P(T_n = t) - P(T_n + [1] = t)| \\ &= \sum_{n=1}^{\infty} |P(\hat{T}_n = t) - P(\tilde{T}_n = t)| \\ &\leq \sum_{n=1}^{\infty} |P(\hat{T}_n = t, \hat{T}_\tau \leq t) - P(\tilde{T}_n = t, \tilde{T}_\tau \leq t)| \\ &\quad + \sum_{n=1}^{\infty} |P(\hat{T}_n = t, \hat{T}_\tau > t) - P(\tilde{T}_n = t, \tilde{T}_\tau > t)| \\ &\leq P(\hat{T}_\tau > t) + P(\tilde{T}_\tau > t). \end{aligned} \tag{6.5}$$

This follows since (6.5) is 0, because  $\hat{T}_n = \tilde{T}_n$  if  $\hat{T}_\tau \leq t$ . The sequence of sets  $\{\hat{T}_n = t\}_{n=1}^{\infty}$  (respectively  $\{\tilde{T}_n = t\}_{n=1}^{\infty}$ ) are disjoint so

$$P(\hat{T}_\tau > t) = \sum_{n=1}^{\infty} P(\hat{T}_n = t, \hat{T}_\tau > t) \text{ and } P(\tilde{T}_\tau > t) = \sum_{n=1}^{\infty} P(\tilde{T}_n = t, \tilde{T}_\tau > t).$$

The result now follows since  $\tau$  is finite. ■

Corollary 6.52 illustrates the power of the coupling method. With probability  $P(\hat{T}_\tau \leq t)$  the two renewal processes  $\{\hat{T}_n\}$  and  $\{\tilde{T}_n\}$  meet before  $t$  and stay together afterward. Since  $\{\hat{T}_n\}$  (respectively  $\{\tilde{T}_n\}$ ) is identical in distribution to  $\{T_n\}$  (respectively  $\{T_n + [1]\}$ ) we see that after a long time  $t$ , we cannot distinguish the distribution of points of  $\{T_n\}$  near  $t$  from those of  $\{T_n + [1]\}$  near  $t$ .

The presence of a Bernoulli part prevents  $\{T_n\}$  from staying on some sublattice of the units. Suppose, however,

$$f_X[2] = f_X[4] = f_X[7] = \frac{1}{3}.$$

Again  $b(X) = 0$  but, in fact, Corollary 6.52 is true! This awkward situation necessitates the following definition.

**Definition 6.53** We say the (delayed) renewal process  $\{T_n\}$  is **spread-out** if there exists a partition  $\ell_0 = 0 < \ell_1 < \ell_2 < \dots$  such that if

$$W_n = \sum_{k=\ell_{n-1}+1}^{\ell_n} X_k$$

then  $\sum_{n=1}^{\infty} b(W_n) = \infty$ .

Clearly if  $\{X_n\}$  is i.i.d. with density  $f(2) = f(4) = f(7) = 1/3$  then  $\ell_n = 2n$  provides a proper partition so  $\{T_n := \sum_{k=1}^n X_k\}$  is spread-out.

**Corollary 6.54** If  $\{T_n\}$  is a spread-out (delayed) renewal process then the Coupling Theorem 6.51 holds and

$$\lim_{t \rightarrow \infty} \sum_{n=1}^{\infty} |P(T_n = t) - P(T_n + [d] = t)| = 0.$$

**Proof:** First take  $d = 1$ . Since  $\{T_n\}$  is spread-out we may set

$$T_{\ell_n} = \sum_{k=1}^n W_k \text{ where } W_k = \sum_{i=\ell_{k-1}+1}^{\ell_k} X_i$$

and  $\sum_{k=1}^{\infty} b(W_k) = \infty$ . Now redo the proof of Corollary 6.52 except that we couple  $\{\hat{T}_{\ell_n}\}$  (which has the same distribution as  $\{T_{\ell_n}\}$ ) and  $\tilde{T}_{\ell_n}$  (which has the same distribution as  $\{T_{\ell_n} + [1]\}$ ). Moreover once  $\{\hat{T}_{\ell_n}\}$  and  $\{\tilde{T}_{\ell_n}\}$  are coupled at time  $\tau$  it is clear we may couple  $\{\hat{T}_n : n \geq \tau\}$  and  $\{\tilde{T}_n : n \geq \tau\}$ . The rest of the proof is the same.

Next,

$$P(T_n = t) - P(T_n + [d] = t) = \sum_{k=0}^{d-1} [P(T_n + k = t) - P(T_n + k + [1] = t)]$$

and for each  $k$

$$\sum_{n=1}^{\infty} |P(T_n + k = t) - P(T_n + k + [1] = t)| \rightarrow 0 \text{ as } t \rightarrow \infty$$

by the above. The result now follows by the triangle inequality. ■

### 6.8 Proof of the Coupling Theorem

We state a preliminary lemma before proving Theorem 6.51.

**Lemma 6.55** If  $\{T_n\}_{n=1}^\infty$  is a renewal process then for  $n \geq 1$  we may construct  $\{J_n, L_n, N_n\}_{n=1}^\infty$  such that  $T_n$  has the same distribution as

$$J_n + \sum_{k=1}^{N_n} L_k$$

where:

$\{L_n\}_{n=1}^\infty$  is independent of  $\{(J_n, N_n)\}_{n=1}^\infty$ ,

$L_n$  is a Bernoulli random variable with parameter  $1/2$ ,

and  $N_n = \sum_{k=1}^n \epsilon_k$ .

Here  $\{\epsilon_k\}_{k=1}^\infty$  is a sequence of independent Bernoulli random variables such that  $E\epsilon_k = b(X_k)$  as in the Bernoulli Part Decomposition 6.50.

**Proof:** Using Lemma 6.50 we can construct a sequence of independent triples  $\{Y_n, \epsilon_n, \tilde{L}_n\}_{n=1}^\infty$  such that  $X_n$  is equal in distribution to  $Y_n + \epsilon_n \tilde{L}_n$ . Hence  $T_n = \sum_{k=1}^n X_k$  is equal in distribution to

$$\sum_{k=1}^n (Y_k + \epsilon_k \tilde{L}_k) = \sum_{k=1}^n Y_k + \sum_{k=1}^n \epsilon_k \tilde{L}_k.$$

Define  $N_n := \sum_{k=1}^n \epsilon_k$  and construct a new totally independent sequence  $\{L_k\}_{k=1}^\infty$  having the same distribution as  $\{\tilde{L}_k\}_{k=1}^\infty$ . Now using the independence of  $\{\tilde{L}_k\}_{k=1}^\infty$  and  $\{(Y_k, \epsilon_k)\}_{k=1}^\infty$  we check that  $\sum_{k=1}^n Y_k + \sum_{k=1}^n \epsilon_k \tilde{L}_k$  is equal in distribution to  $\sum_{k=1}^n Y_k + \sum_{k=1}^{N_n} L_k$  (see Exercise 6.3). Finally setting  $J_n = \sum_{k=1}^n Y_k$  we have the proof.  $\blacksquare$

The following lemma shows the power of the Bernoulli part decomposition and is used later.

**Lemma 6.56** Consider a renewal process  $\{T_n\}$  and let  $0 = \ell_0 < \ell_1 < \ell_2 < \dots$  be a partition such that  $W_i = \sum_{k=\ell_{i-1}+1}^{\ell_i} X_k$  has Bernoulli part  $b(W_i)$ . If  $M$  is any index such that  $M \geq \ell_n$  then

$$\sum_{x=-\infty}^{\infty} |P(T_M = x) - P(T_M + [1] = x)| \leq CE(1 - N_n)^{-1/2}$$

where  $N_n = \sum_{k=1}^n \epsilon_k$  and where  $\{\epsilon_k\}_{k=1}^\infty$  is a sequence of independent Bernoulli random variables such that  $E\epsilon_k = b(W_k)$ .



**Proof:** First let  $T_M = T_{\ell_n} + U$  where  $U := T_M - T_{\ell_n}$ . As before, decompose  $T_{\ell_n} = J_n + \sum_{k=1}^{N_n} L_k$ . Now

$$\begin{aligned}
 & \sum_{x=-\infty}^{\infty} |P(T_M = x) - P(T_M + [1] = x)| \\
 &= \sum_{x=-\infty}^{\infty} \left| P\left(U + J_n + \sum_{k=1}^{N_n} L_k = x\right) - P\left(U + J_n + \sum_{k=1}^{N_n} L_k + [1] = x\right) \right| \\
 &= \sum_{x=-\infty}^{\infty} \left| \sum_{u=-\infty}^{\infty} \sum_{j=0}^{\infty} \sum_{m=0}^{\infty} P(J_n = j, N_n = m, U = u) \cdot \right. \\
 & \quad \left. \left[ P\left(\sum_{k=1}^m L_k = x - j - u\right) - P\left(\sum_{k=1}^m L_k = x - j - u - [1]\right) \right] \right| \\
 &\leq \sum_{u=-\infty}^{\infty} \sum_{j=0}^{\infty} \sum_{m=0}^{\infty} P(J_n = j, N_n = m, U = u) \cdot \\
 & \quad \sum_{x=-\infty}^{\infty} \left| P\left(\sum_{k=1}^m L_k = x - j - u\right) - P\left(\sum_{k=1}^m L_k = x - j - u - [1]\right) \right| \\
 &= \sum_{m=0}^{\infty} P(N_n = m) \sum_{x=-\infty}^{\infty} \left| P\left(\sum_{k=1}^m L_k = x\right) - P\left(\sum_{k=1}^m L_k + [1] = x\right) \right| \\
 &\leq \sum_{m=0}^{\infty} P(N_n = m) \cdot 2 \cdot \binom{m}{\lfloor m/2 \rfloor} 2^{-m}.
 \end{aligned}$$

The last inequality holds since the distribution of  $\sum_{k=1}^m L_k$  is a binomial so for  $x \leq \lfloor \frac{m}{2} \rfloor$  ( $\lfloor \cdot \rfloor$  is the greatest integer function) we have

$$P\left(\sum_{k=1}^m L_k = x\right) > P\left(\sum_{k=1}^m L_k + [1] = x\right)$$

while for  $x > \lfloor \frac{m}{2} \rfloor$

$$P\left(\sum_{k=1}^m L_k = x\right) \leq P\left(\sum_{k=1}^m L_k + [1] = x\right).$$

The inequality follows by telescoping. Finally by Stirling's inequality (see Exercise 6.4)

$$2^{-m} \binom{m}{\lfloor m/2 \rfloor} \leq \frac{c}{\sqrt{1+m}}, \quad (6.6)$$

where  $c$  is a universal constant. Hence

$$\begin{aligned} & \sum_{x=-\infty}^{\infty} |P(T_M = x) - P(T_M + [1] = x)| \\ & \leq \sum_{m=0}^{\infty} P(N_n = m) \frac{2c}{\sqrt{1+m}} \\ & = 2cE(1 + N_n)^{-1/2}. \end{aligned}$$

Taking  $C = 2c$  we have the result. ■

**Proof of 6.51:** Use Lemma 6.55 to construct  $\{\hat{T}_n = J_n + \sum_{k=1}^{N_n} L_k\}_{n=1}^{\infty}$  which is equal in distribution to  $\{T_n\}_{n=1}^{\infty}$ . Next using a totally independent sequence  $\{L'_k\}_{k=1}^{\infty}$  equal in distribution to  $\{L_k\}_{k=1}^{\infty}$  define

$$T'_n := J_n + \sum_{k=1}^{N_n} L'_k + [1].$$

Clearly  $\{T'_n\}$  is equal in distribution to  $\{T_n + [1]\}$ . Moreover

$$\hat{T}_n - T'_n = \sum_{k=1}^{N_n} (L_k - L'_k) - [1].$$

Now  $W_n = \sum_{k=1}^n (L_k - L'_k) - [1]$  is a simple symmetric random walk on the units so by Example 5.67,  $W_n$  hits 0 at some finite random time  $\tau$  ( $\tau = \inf\{n > 0 : W_n = 0\}$ ). Moreover  $N_n = \sum_{k=1}^n \epsilon_k \rightarrow \infty$  as  $n \rightarrow \infty$  using the Borel-Cantelli lemma (see the Appendix) and the fact that  $E\epsilon_k = b(X_k)$  and  $\sum_{k=1}^n b(X_k) \rightarrow \infty$  as  $n \rightarrow \infty$ . Hence  $\{\hat{T}_n\}$  and  $\{T'_n\}$  are coupled at the same time  $\tau$  and, moreover,  $\tau$  is a stopping time for the filtration  $\{\mathcal{F}_t\}_{t=0}^{\infty}$  where  $\mathcal{F}_t = \sigma\{\hat{X}_k, X'_k : k \leq t\}$ . This follows since  $\{\tau = t\} = \{\hat{T}_k \neq T'_k \text{ for } k \leq t-1, T_t = T'_t\}$  and this event certainly lies in  $\mathcal{F}_t$ . Now define a new point process  $\tilde{T}_n$ :

$$\tilde{T}_n = \begin{cases} T'_n & \text{for } n \leq \tau \\ T_n & \text{for } n > \tau. \end{cases}$$

Now we check  $\{\tilde{T}_n\}$  is equal in distribution to  $\{T'_n\}$ . First  $\tilde{T}_n = T'_n$  for  $n \leq \tau$ . Next for  $n > \tau$ ,  $\tilde{T}_n = T'_\tau + \sum_{k=\tau+1}^n X_k$ . However,

$$\begin{aligned} &P\left(\sum_{k=\tau+1}^n X_k = x, \tau < n\right) \\ &= \sum_{j=1}^{n-1} P(\tau = j)P\left(\sum_{k=j+1}^n X_k = x \mid \tau = j\right) \\ &= \sum_{j=1}^{n-1} P(\tau = j)P\left(\sum_{k=j+1}^n X_k = x\right) \text{ since } \{\tau = j\} \in \mathcal{F}_j \\ &= \sum_{j=1}^{n-1} P(\tau = j)P\left(\sum_{k=j+1}^n X'_k = x\right) \\ &= P\left(\sum_{k=\tau+1}^n X'_k = x, \tau < n\right) \end{aligned}$$

(since the interarrival times of  $\{T_n\}$  equal those of  $\{T'_n\}$ ).

Hence  $\{\tilde{T}_n\}$  is equal in distribution to  $\{T'_n\}$  which in turn is equal in distribution to  $\{T_n + [1]\}$  and  $\tilde{T}_n = T_n$  for  $n \geq \tau$  by construction. ■

### 6.9 Regenerative Processes

Let  $\|\cdot\|$  denote the total variation of a measure on  $\{1, 2, 3, \dots\} \times \{[0], [1], [2], \dots\}$  so

$$\|\alpha(n, x)\| = \sum_{n=1}^{\infty} \sum_{x=0}^{\infty} |\alpha(n, x)|.$$

**Theorem 6.57** *Let  $\{T_n\}$  be a delayed renewal process which is spread-out. We recall that the  $n^{\text{th}}$  interarrival time has distribution  $F_n$  and mean  $\mu_n$ . If, for all  $n$  and  $x$ ,  $1 - F_n[x] \leq H[x]$ , where  $H$  is such that  $\sum_{x=0}^{\infty} H[x] < \infty$ , then*

$$\left\|P(Z[t] = x, T_{n-1} \leq t < T_n) - \frac{(1 - F_n[x])}{\mu_n} P(T_{n-1} \leq t < T_n)\right\|$$

tends to 0 as  $t \rightarrow \infty$ .

This means that for large  $t$ , the joint distribution of the cycle number and the age,  $(n, x)$ , is close in total variation to the product measure of marginal distribution of the cycle number,  $P(N[t] = n - 1) = P(T_{n-1} \leq t < T_n)$  and the stationary renewal measure associated with this cycle,  $(1 - F_n[x])/\mu_n$ .

**Proof:** First, notice that

$$P(Z[t] = x, T_{n-1} \leq t < T_n) = (1 - F_n[x])P(T_{n-1} = t - x).$$

Next,

$$\sum_{n=1}^{\infty} \sum_{x=0}^{\infty} |P(Z[t] = x, T_{n-1} \leq t < T_n) - (1 - F_n[x])P(T_{n-1} = t)| \quad (6.7)$$

$$\leq \sum_{x=0}^{\infty} H[x] \sum_{n=1}^{\infty} |P(T_{n-1} = t - x) - P(T_{n-1} = t)|. \quad (6.8)$$

Now for any  $x$ ,

$$\sum_{n=1}^{\infty} |P(T_{n-1} = t - x) - P(T_{n-1} = t)| \rightarrow 0 \quad (6.9)$$

as  $t \rightarrow \infty$  by Corollary 6.54. Moreover if we define the summand in (6.8) as

$$\alpha(x, t) = H[x] \sum_{n=1}^{\infty} |P(T_{n-1} = t - x) - P(T_{n-1} = t)|$$

then  $|\alpha(x, t)| \leq 2H[x]$  since

$$\sum_{n=1}^{\infty} P(T_{n-1} = t - x) \leq 1 \text{ and } \sum_{n=1}^{\infty} P(T_{n-1} = t) \leq 1$$

because  $\{T_n\}$  is strictly increasing. Equation (6.9) shows that for each  $x$ ,  $\lim_{t \rightarrow \infty} \alpha(x, t) = 0$ . Finally, since  $\sum_{k=0}^{\infty} 2H[k] < \infty$ , we conclude that (6.8) tends to 0 as  $t \rightarrow \infty$  by dominated convergence. It follows that expression (6.7) also tends to 0 as  $t \rightarrow \infty$ .

Next summing (6.7) in  $x$  we get

$$\lim_{t \rightarrow \infty} \sum_{n=1}^{\infty} |P(T_{n-1} \leq t < T_n) - \mu_n P(T_{n-1} = t)| = 0. \quad (6.10)$$

Now,

$$\begin{aligned} & \sum_{n=1}^{\infty} \sum_{x=0}^{\infty} |P(Z[t] = x, T_{n-1} \leq t < T_n) - \frac{(1 - F_n[x])}{\mu_n} P(T_{n-1} \leq t < T_n)| \\ & \leq \sum_{n=1}^{\infty} \sum_{x=0}^{\infty} |P(Z[t] = x, T_{n-1} \leq t < T_n) - (1 - F_n[x])P(T_{n-1} = t)| \\ & \quad + \sum_{n=1}^{\infty} \sum_{x=0}^{\infty} |(1 - F_n[x])P(T_{n-1} = t) - \frac{(1 - F_n[x])}{\mu_n} P(T_{n-1} \leq t < T_n)|. \end{aligned}$$

Clearly the first term of this inequality tends to 0 as  $t \rightarrow \infty$  by (6.7). The second term is bounded by

$$\begin{aligned} & \sum_{x=0}^{\infty} H[x] \sum_{n=1}^{\infty} \left| P(T_{n-1} = t) - \frac{1}{\mu_n} P(T_{n-1} \leq t < T_n) \right| \\ & \leq \sum_{x=0}^{\infty} H[x] \sum_{n=1}^{\infty} |P(T_{n-1} \leq t < T_n) - \mu_n P(T_{n-1} = t)| \end{aligned}$$

since  $\mu_n \geq [1]$  and the above tends to 0 using (6.10). This proves the theorem. ■

Remark that the condition  $1 - F_n[x] \leq H[x]$  would hold if for instance  $\sup_n EX_n^{1+\delta} < \infty$  (see Exercise 6.2).

**Corollary 6.58** *Let  $\{T_n\}$  be a delayed renewal process which is spread-out. Then*

$$\lim_{t \rightarrow \infty} \sum_{x=0}^{\infty} \left| P(Z[t] = x) - \sum_{n=1}^{\infty} \frac{1 - F_n[x]}{\mu_n} P(T_{n-1} \leq t < T_n) \right| = 0$$

and

$$\lim_{t \rightarrow \infty} \left| P(\text{renewal at } t) - \sum_{n=1}^{\infty} \frac{1}{\mu_n} P(T_{n-1} \leq t < T_n) \right| = 0.$$

If all the  $\mu_n = \mu$  then

$$\lim_{t \rightarrow \infty} \left| P(\text{renewal at } t) - \frac{1}{\mu} \right| = 0.$$

**Proof:** The first limit is obtained by taking the summation in  $n$  in Theorem 6.57 inside the absolute value sign. The second limit is obtained from the first by taking  $x = 0$ . ■

**Theorem 6.59** *If  $V[t]$  is a regenerative process with embedded (delayed) renewal process  $\{T_n\}$  which is spread-out then*

$$\lim_{t \rightarrow \infty} \sup_{A \in \mathcal{U}} \sum_{n=1}^{\infty} |P(V[t] \in A, T_{n-1} \leq t < T_n) - \frac{\alpha_n}{\mu_n} P(T_{n-1} \leq t < T_n)| = 0,$$

where  $\mathcal{U}$  are measurable subsets such that  $\{V[t] \in A\} \in \mathcal{F}$  and  $\alpha_n = \sum_{t=0}^{\infty} \{V^n[t] \in A, t < X_n\}$ ; that is  $\alpha_n$  is the mean time  $V[t]$  spends in  $A$  during the  $n^{\text{th}}$  cycle.

**Proof:**

$$\begin{aligned} P(V[t] \in A, T_{n-1} \leq t < T_n) &= P(V^n[Z[t]] \in A, T_{n-1} \leq t < T_n) \\ &= \sum_{x=0}^{\infty} P(Z[t] = x, T_{n-1} \leq t < T_n) P(V^n[x] \in A | X_n > x) \end{aligned}$$

since the event

$$\{Z[t] = x, T_{n-1} \leq t < T_n\} = \{T_{n-1} = t - x, X_n > x\}$$

and  $V^n[x]$  depends only on  $X_n$ . Hence

$$\begin{aligned} & \lim_{t \rightarrow \infty} \sup_{A \in \mathcal{U}} \sum_{n=1}^{\infty} |P(V[t] \in A, T_{n-1} \leq t < T_n) \\ & \quad - \sum_{x=0}^{\infty} \frac{(1 - F_n[x])}{\mu_n} P(T_{n-1} \leq t < T_n) P(V^n[x] \in A | X_n > x)| \\ & \leq \lim_{t \rightarrow \infty} \sup_{A \in \mathcal{U}} \sum_{n=1}^{\infty} \sum_{x=0}^{\infty} P(V^n[x] \in A | X_n > x) \\ & \quad \cdot |P(Z[t] = x, T_{n-1} \leq t < T_n) - \frac{(1 - F_n[x])}{\mu_n} P(T_{n-1} \leq t < T_n)| \\ & = 0 \end{aligned}$$

by Theorem 6.57 and the fact that  $P(V^n[x] \in A | X_n > x) \leq 1$ . Finally,

$$\begin{aligned} & \sum_{x=0}^{\infty} \frac{(1 - F_n[x])}{\mu_n} P(T_{n-1} \leq t < T_n) P(V^n[x] \in A | X_n > x) \\ & = \frac{1}{\mu_n} \sum_{x=0}^{\infty} P(V^n[x] \in A, X_n > x) \cdot P(T_{n-1} \leq t < T_n) \\ & = \frac{\alpha_n}{\mu_n} \cdot P(T_{n-1} \leq t < T_n). \end{aligned}$$

This completes the proof. ■

**Corollary 6.60** *Under the hypotheses of Theorem 6.59*

$$\lim_{t \rightarrow \infty} \sup_{A \in \mathcal{U}} |P(V[t] \in A) - \sum_{n=1}^{\infty} \frac{\alpha_n}{\mu_n} P(T_{n-1} \leq t < T_n)| = 0.$$

**Proof:** Simply take the summation in  $n$  in Theorem 6.59 inside the absolute value sign. ■

**Example 6.61 Alternating renewal processes – (6.6) continued**

We may apply Corollary 6.60 to Example 6.6 by taking  $A = \{1\}$  so  $\alpha_n = EU_n$  and  $\mu_n = EU_n + ER_n$ . We conclude

$$\lim_{t \rightarrow \infty} |P(\text{a machine is working at } t) - \sum_{n=1}^{\infty} \frac{\alpha_n}{\mu_n} P(T_{n-1} \leq t < T_n)| = 0.$$

This is a very pleasing answer since we should expect that given the process  $V[t]$  is on the  $n^{\text{th}}$  cycle, the probability machine  $n$  is working should be  $\alpha_n/\mu_n$  – the ratio of the mean working time to the mean cycle length  $\mu_n \equiv EX_n$ . This ratio is weighted by  $P(T_{n-1} \leq t < T_n)$ ; the probability that we are in the  $n^{\text{th}}$  cycle at time  $t$ .

---

## 6.10 Exercises

Exercise 6.1 Complete the proof of Lemma 6.50.

Exercise 6.2 If  $\sup EX_n^{1+\delta} < \infty$  show that  $1 - F_n[x] \leq H[x]$  for some function  $H$  such that  $\sum_{[x]=0}^{\infty} H[x] < \infty$ .

Exercise 6.3 In Lemma 6.55 prove  $\sum_{k=1}^n Y_k + \sum_{k=1}^n \epsilon_k \tilde{L}_k$  is equal in distribution to  $\sum_{k=1}^n Y_k + \sum_{k=1}^{N_n} L_k$ .

Exercise 6.4 Consult Feller Volume I for Stirling's formula:

$$n! \sim (2\pi)^{1/2} n^{n+1/2} e^{-n}.$$

Show (6.6) using Stirling's formula.

Exercise 6.5 If the mean and variance of the interarrival distribution of a homogeneous renewal process  $N(t)$  are  $\mu$  and  $\sigma^2$  respectively show that

$$\frac{N(t) - (t/\mu)}{\sqrt{t\sigma^2/\mu^3}} \rightarrow N(0, 1)$$

where  $\rightarrow N(0, 1)$  denotes convergence in distribution to a standard normal.

Exercise 6.6 If the mean and variance of the interarrival distribution of a homogeneous renewal process are  $\mu$  and  $\sigma^2$  show that the limiting distribution of the age  $Z[t]$  at  $t$  has mean  $(\sigma^2 + \mu^2)/2\mu - [1]/2$ .

Exercise 6.7 A cop on subway patrol starts and finishes his day at union station. His duty is to hop aboard the first train entering the station and to do a complete return trip to union station and then repeat the process again and again. Assume there are three different lines. Line A takes 20 minutes round trip, line B takes 15 minutes and line C takes 30 minutes. The trains arrive according to a Bernoulli (Poisson) process. Those of line A arrive at a rate of 20 per hour; those of line B at 50 per hour and those of line C at 20 per hour.

- What is the long run proportion of the times the cop hops onto train B?
- What is the long run proportion of time spent waiting at union station?

Exercise 6.8 Consider an elevator with three stops  $G$  (for ground), 1 and 2. The elevator moves from floor to floor according to the matrix  $P$ :

$$\begin{pmatrix} 0 & 1/2 & 1/2 \\ 3/4 & 0 & 1/4 \\ 4/5 & 1/5 & 0 \end{pmatrix}.$$

The time to move from one floor to another is proportional to the distance travelled and is 10 seconds per floor.

- Assuming the elevator spends 30 seconds at each stop find an expression for the long run proportion of time spent moving directly from the ground floor to the

second floor.

b) Give the numerical value. Hint: define a function  $h(x) : x \in \{G, 1, 2\}$  where  $h(x)$  is the mean time to return to G starting from  $x$ . Write down a system of equations for  $h$  using the Markov property.

**Exercise 6.9** Mail trucks leave the postal depot according to a renewal process with interarrival distribution  $F$  and mean  $\mu$  while letters arrive at the postal depot according to a Poisson process with rate  $\lambda$ . What is the long run fraction of letters which arrive which wait in the depot for a time not exceeding  $\ell$ .

**Exercise 6.10** Containers arrive at a depot according to a Poisson process at a rate of 3 per hour day and night. When there are 10 containers at the depot a truck is called. The truck arrives after one hour and takes one hour to load and then leaves. The truck takes the 10 containers plus any that arrive before departure.

- What is the long run average number of trucks called per day?
- If we rush to the depot with a container, what is the probability there is a truck waiting there now?

**Exercise 6.11** A taxi company knows by past experience that a taxi will run for a random number months which we denote by  $T$ .  $T$  has a distribution

$$F(t) = \begin{cases} 0 & t < 1 \\ \frac{21}{20}(1 - \frac{1}{t}) & 1 \leq t < 21 \\ 1 & t \geq 21. \end{cases}$$

A taxi that breaks down is worth nothing and a replacement costs \$30,000. The company has a policy of replacing a taxi after  $p = 14$  months of use (if it hasn't broken down first). The used taxi may be sold for  $\$D$  where  $D$  is a random variable with mean \$10,000.

- Calculate the long-run average cost cost of keeping one taxi in service using this replacement policy.
- Find a value  $p$  which minimizes the long-run average cost per taxi.

The taxi company has just gone bankrupt. You wish to buy one of the taxis still in service but you don't know how long any of these taxis have been used.

- Find the approximate distribution of the number of months use you will get out of the used taxi until it breaks down.

**Exercise 6.12** The police department keeps 100 cars in service at all times. Past studies across the country have shown that the number of months a police car can remain roadworthy has a geometric distribution with a mean of 2 years due to accidents and hard usage. In this department, a car still in service after 18 months is sold off and replaced by a new car. This maintenance policy has been followed for many years but today the mayor has declared a financial emergency and declared no new cars will be bought for the foreseeable future. What is the probability more



than 30 of the cars now in service are over one year old and what is the mean age of the cars now in service?

**Exercise 6.13** An Ace airport shuttle bus which has a capacity of ten leaves whenever 10 customers are in the queue or 15 minutes after the previous shuttle bus left whichever comes first. The customer arrivals may be modelled by a Poisson process with a mean arrival rate of 30 per hour.

- a) What is the long run average number of shuttle buses dispatched per hour?
- b) What is the approximate probability that at a given time, say 2:13 PM there will be nobody in the queue?

**Exercise 6.14** The time to wire a specialized circuit board cannot be predicted because several steps may have to be repeated when a component breaks during soldering. The empirical histogram of the wiring times is approximately given by the following probability mass function  $f(x)$ :

$x$ hours	1	2	3	4	5	6
$f(x)$	.1	.2	.2	.3	.1	.1

There is only one work position for wiring this kind of circuit board but production goes on 24 hours a day. As soon as one worker finishes a shift of 8 hours another worker takes his or her place.

- a) Calculate the expected amount of time to produce this circuit board.
- b) Calculate the long run average number of circuit boards produced per shift.
- c) When a worker ends a shift a circuit board may be left incomplete. The next worker just takes over at the point where the last worker left off (or takes over a new board if the last worker just completed his). Give the distribution of the number of hours of work already done on the board the next worker takes over.
- d) Give the mean amount of work already done on the boards the next worker takes over.
- e) Give the distribution of the amount of work left to do on the boards the next worker takes over.
- f) Give the mean amount of work left to be done on the board the next worker takes over.
- g) Why is the sum of part e) and part c) not equal to the mean calculated in a).

**Exercise 6.15** One can simulate the regeneration intervals of an  $M|G|1$  queue by starting the queue off empty and simulating until it empties out again. Given the length of the interarrival interval containing 0 is  $\ell$ , the age at 0 is uniformly distributed on  $[0, \ell - 1]$ . Use this fact to simulate an  $M|G|1$  queue in equilibrium.

Do this for  $G$  uniform. Estimate the equilibrium probability the queue is empty and compare this with the theoretical value.

**Exercise 6.16** Consider a process  $X[t]$  which alternates between two states, on and off. The distribution of the on and off periods are  $F$  and  $G$  respectively and we consider these periods independent. Find the steady state distribution of the excess time in an on period; that is given the process is in steady state and given we are in an on period, calculate the distribution of the time until the next off period starts.

**Exercise 6.17** A DNS (Domain Name Server) translates web addresses into domain names. Each request for a web page generates a request at the DNS server. We can assume there is always a queue of requests. Lookups take a variable amount of time. To simplify we can say 50% take one time unit, 25% take 2 time units and 25% take three time units. Occasionally priority requests are received and these go immediately to the head of the queue but don't preempt the lookup in progress. We are interested in the (potential) delay  $D(t)$  if a priority request did arrive at time unit  $t$ .

- a) Model the delay process  $D(t)$  as a Markov chain. Write down the state space and the transition kernel.
- b) Calculate the stationary distribution of  $D(t)$ .
- c) What is the long run proportion of priority requests which are processed immediately.

**Exercise 6.18** A processor receives work from two independent Poisson streams of jobs, one low priority and one high priority. The length of time to process any job is exponentially distributed with a mean of 1 minute. The high priority jobs arrive at a rate of 10 per hour while the low priority jobs arrive at a rate of 20 per hour. High priority jobs always go first and even preempt low priority jobs (i.e. a low priority job is stopped if a high priority job arrives). Jobs wait in a queue until served (assume any number of jobs can be queued). We assume the system is in steady state.

- a) If we ignore the priority of the jobs how can we describe this queueing system?
- b) What is the mean number of jobs in the system at a given time.
- c) What proportion of the time is the server idle?
- d) What is the mean system time in this system.
- e) What is the mean number of high priority jobs in the system at a given time?
- f) What proportion of the time is the server busy with high priority jobs?
- g) What is the mean system time for high priority jobs?
- h) What is the mean waiting time for high priority jobs?
- i) What is the mean number of low priority jobs in the system at a given time?
- j) What proportion of the time is the server busy with low priority jobs?
- k) What is the mean system time of low priority jobs?
- l) What is the mean waiting time of low priority jobs?

## Chapter 7

# Markov Processes

### 7.1 Introduction

A Markov process visits a state for a random sojourn time having an exponential distribution before jumping to the next state. These processes can be used to approximate Markov chains just as the Poisson process approximates the Bernoulli process. The advantage of the approximation is that we can often give the transient behavior of the Markov process explicitly. Markov processes are commonly used for describing queues when customers arrive according to Poisson processes or when service time distributions are exponential. Networks of such queues are widely used to model manufacturing and telecommunication systems and we will at least get an introduction to this interesting area of queueing networks.

We let  $X(t)$  represent the state at time  $t$  measured in seconds in a countable state space  $S$  which we may take to be  $\{0, 1, 2, \dots\}$ . We proceed as with the Poisson process; that is, we approximate a discrete time Markov chain by a continuous time Markov process. The notion of norms described below will be very useful when we try to measure the accuracy of the approximation!

**We shall assume that time is measured in multiples of a time unit which may be taken to be nanoseconds. We keep the notation developed in Chapter 4 and use square brackets to indicate both rounding up to the next integer and that a measurement is in nanoseconds. Any time  $t$  measured in seconds is denoted by  $\hat{t} = [7t]$  when measured in nanoseconds.**

Functions defined on  $S$  taking real values may be thought of as vectors having a countable number of components. The natural addition of functions,  $(u + v)(i) := u(i) + v(i)$  and the multiplication by real numbers,  $(\alpha u)(i) = \alpha u(i)$ , makes the set of such functions a vector space. If  $v$  is a function defined on  $S$  we define  $\|v\| := \sup_{i \in S} |v(i)|$ . It is easy to check that  $\|v\|$  is a length or norm of  $v$ . It suffices to verify the following conditions satisfied by any norm. For any two vectors  $u, v$  and any real number  $\alpha$

$$\|v\| \geq 0, \|u + v\| \leq \|u\| + \|v\|, \|\alpha v\| = |\alpha| \cdot \|v\|$$

and moreover  $\|v\| = 0$  implies  $v \equiv \mathbf{0}$ . For instance

$$\begin{aligned} \|u + v\| &= \sup_{i \in S} |u(i) + v(i)| \\ &\leq \sup_{i \in S} (|u(i)| + |v(i)|) \\ &\leq \sup_{i \in S} |u(i)| + \sup_{i \in S} |v(i)| \\ &= \|u\| + \|v\|. \end{aligned}$$

The set  $\mathcal{B}$ , of functions on  $S$ , having finite norm forms a Banach space, a complete normed vector space. This is shown in the Appendix. Another normed vector space is formed by linear transformations  $T$  of  $\mathcal{B}$  into itself.  $T$  transforms the vector  $u \in \mathcal{B}$  into the vector  $Tu$ , where  $Tu(i) = \sum_j T_{ij}u(j)$ . Since the space  $S$  is always countable, then  $T$  may be represented as a matrix multiplying vectors  $v$ . The norm is defined by  $\|T\| := \sup\{\|Tv\| : \|v\| \leq 1\}$ . Note that

$$\|Tv\| = \sup_i \{|Tv(i)|\} = \sup_i \left\{ \left| \sum_j T_{ij}v(j) \right| \right\} \leq \sup_i \left\{ \sum_j |T_{ij}| \right\}$$

if  $\|v\| \leq 1$  and the equality  $\sum_j T_{ij}v(j) = \sum_j |T_{ij}|$  is attained by letting  $v(j)$  denote the sign of  $T_{ij}$ . Consequently

$$\|T\| = \sup_i \left\{ \sum_j |T_{ij}| \right\} \tag{7.1}$$

in this norm.

As an example note that if  $T$  is a Markov transition kernel on  $S$ , then  $\|T\| = 1$ . To show this take  $v = \mathbf{1}$ , the vector of 1's. Since  $T$  is a Markov transition kernel,  $T\mathbf{1} = \mathbf{1}$  and since by definition  $\|\mathbf{1}\| = 1$ , it follows that  $\|T\| \geq \|T\mathbf{1}\| = \|\mathbf{1}\| = 1$ . It is also clear  $\|T\| \leq 1$  so  $\|T\| = 1$ .

This space of transformations again forms a Banach space with the given norm but we won't show this here. Instead, we show that convergence of a sequence of transformations  $T^n$  to  $T$  in this norm, implies the components of the transformations converge. Pick  $e_j$  to be the function which is 1 at state  $j$  and 0 elsewhere. It follows that  $\|e_j\| = 1$ . Hence

$$\begin{aligned} |T^n_{ij} - T_{ij}| &= |T^n e_j(i) - T e_j(i)| \\ &\leq \|T^n e_j - T e_j\| \\ &\leq \|T^n - T\|. \end{aligned}$$

If  $\lim_{n \rightarrow \infty} \|T^n - T\| = 0$ , it follows that the  $ij^{\text{th}}$  component of  $T^n - T$  tends to 0; that is the  $ij^{\text{th}}$  component of  $T^n$  converges.

## 7.2 The Generator of a Markov Process

We start with the description of a Markov chain which may jump every nanosecond (or picosecond or ... ) but with very small probability. We consider transition kernels of the following general form:

**Definition 7.1**  $T^\eta$  is the probability transition of a discrete-time Markov chain, with generator  $G$  on a countable state space  $S$ , if the transition in each time unit ( $1/\eta$  seconds) may be represented by a kernel  $T^\eta$  of the form:

$$T^\eta = I + \frac{1}{\eta}G + \frac{1}{\eta^2}L_\eta \quad (7.2)$$

where  $I$  is the identity matrix,  $G$  is a matrix such that  $\|G\| < \infty$  and  $L_\eta$  is a matrix which may depend on  $\eta$  such that  $\|L_\eta\| < \infty$  uniformly in  $\eta$ .

### Example 7.2 Contending processors

A computer has two processors. Jobs arrive according to a Bernoulli process with a rate of 10 per second and grab one of the processors if one is free; if not the job is lost. The processing time of a job is random having a geometric (discrete exponential) distribution with a mean of one quarter of a second. Let the state of the system at time  $t$  be the number of busy processors. We calculate the transition kernel  $T^\eta$  describing the transitions that occur in one nanosecond. Suppose there are 0 jobs being processed. Since the time between arrivals is a geometric (discrete exponential) distribution having mean  $1/10$  of a second ( $[\eta/10]$  nanoseconds) it follows that in the next nanosecond an arrival occurs with probability  $p = 10/\eta$  (or else there is no arrival). Hence  $T_{00}^\eta = 1 - 10/\eta$ ,  $T_{01}^\eta = 10/\eta$  and  $T_{02}^\eta = 0$ . If one of the processors is occupied there are two things that might happen in one nanosecond. A job may arrive to grab the free processor with probability  $10/\eta$  or the busy processor may finish its job with probability  $4/\eta$ . If neither of these independent events occurs or if both occur we stay in state 1 hence  $T_{11}^\eta = (1 - 10/\eta)(1 - 4/\eta) + 10/\eta \cdot 4/\eta = 1 - 14/\eta + 2(10/\eta \cdot 4/\eta)$ . There is an arrival without a departure with probability  $10/\eta \cdot (1 - 4/\eta)$  and there is a departure without an arrival with probability  $4/\eta \cdot (1 - 10/\eta)$ . Hence  $T_{12}^\eta = 10/\eta \cdot (1 - 4/\eta)$  and  $T_{10}^\eta = 4/\eta \cdot (1 - 10/\eta)$ . With both processors busy, we may in one nanosecond see 1 or 2 departures with probabilities  $2 \cdot 4/\eta$  or  $(4/\eta)^2$ . If none of the processors gets free or if one gets free and a job arrives, we remain in state 2. Hence  $T_{22}^\eta = 1 - 2 \cdot 4/\eta - (4/\eta)^2 + 2 \cdot 4/\eta \cdot 10/\eta = 1 - 2 \cdot 4/\eta + 64/\eta^2$ . If one processor gets free and there are no arrivals or if there are two departures and one arrival, we jump to state 1. Thus  $T_{21}^\eta = (2 \cdot 4/\eta)(1 - 10/\eta) + (4/\eta)^2 10/\eta = 2 \cdot 4/\eta - 80/\eta^2 + 160/\eta^3$ . Finally there are two departures and no arrival with probability  $T_{20}^\eta = (4/\eta)^2(1 - 10/\eta) =$

$(4/\eta)^2 - 160/\eta^3$ . We summarize by writing out the transition kernel  $T^\eta$  as a matrix.

$$\begin{pmatrix} 1 - 10/\eta & 10/\eta & 0 \\ (1 - 10/\eta)4/\eta & 1 - 14/\eta + 80/\eta^2 & (1 - 4/\eta)10/\eta \\ (4/\eta)^2 - 160/\eta^3 & 2 \cdot 4/\eta - 80/\eta^2 + 160/\eta^3 & 1 - 2 \cdot 4/\eta + 64/\eta^2 \end{pmatrix} \\ = I + \frac{1}{\eta}G + \frac{1}{\eta^2}L_\eta,$$

where

$$L_\eta = \begin{pmatrix} 0 & 0 & 0 \\ -40 & 80 & -40 \\ 16 - 160/\eta & -80 + 160/\eta & 64 \end{pmatrix}$$

and the generator  $G$  is given by

$$G = \begin{pmatrix} -10 & 10 & 0 \\ 4 & -14 & 10 \\ 0 & 8 & -8 \end{pmatrix}.$$

Here we restrict ourselves to generators such that  $\|G\| < \infty$ . Since the vector  $\mathbf{1}$  is a right eigenvector for  $T^\eta$  having eigenvalue 1 it follows from (7.2) that

$$\frac{1}{\eta}G\mathbf{1} + \frac{1}{\eta^2}L_\eta\mathbf{1} = \mathbf{0}. \quad (7.3)$$

Multiplying (7.3) by  $\eta$  and letting  $\eta$  tend to  $\infty$  it follows that  $G\mathbf{1} = \mathbf{0}$  since by hypothesis  $\|L_\eta\|$  is uniformly bounded. We conclude the row sums of the generator  $G$  are 0. Further rearranging (7.2) and multiplying by  $\eta$  we get

$$\eta(T^\eta - I) = G + \frac{1}{\eta}L_\eta.$$

Since  $T^\eta - I$  has non-negative elements off the diagonal and non-positive elements on the diagonal, letting  $\eta$  tend to  $\infty$  we see  $G$  has the same property (the components of  $\frac{1}{\eta}L_\eta$  tend to 0).

Since only the diagonals of  $G$  are negative the  $i^{\text{th}}$  component of  $Gv$  is maximized by the vector

$$v^* = (1, 1, \dots, 1, \underbrace{-1}_{i^{\text{th}} \text{ component}}, 1, \dots, 1)$$

among all vectors  $v$  having norm 1 ( $*$  denotes the transpose). In this case  $(Gv)_i = 2|G_{ii}|$ . Hence

$$q := \frac{1}{2}\|G\| = \frac{1}{2} \sup\{\|Gv\| : \|v\| \leq 1\} = \sup_i |G_{ii}|. \quad (7.4)$$

**Definition 7.3** In general, a generator has non-negative off-diagonal elements and the row sums are 0. We denote the transition rate from state  $i$  to state  $j$  ( $i \neq j$ ) by  $q(i, j)$ ; that is  $q(i, j) = G_{ij}$ . The total transition rate from state  $i$  is denoted by  $q(i)$ ; that is  $q(i) = -G_{ii} = \sum_{j \in S \setminus \{i\}} q(i, j)$ . The proportion of the transition rate directed from  $i$  to  $j$  ( $i \neq j$ ) is  $K_{ij} := q(i, j)/q(i)$ . Set  $K_{ii} = 0$  and call  $K$  the transition kernel of the embedded chain.

Since  $T^\eta \approx I + \frac{1}{\eta}G$ , we see that after one nanosecond the probability there is a transition from  $i$  to  $j$  is approximately  $q(i, j)\frac{1}{\eta}$  and the probability of a jump from  $i$  is approximately  $q(i)\frac{1}{\eta}$ . Given there is a jump from  $i$ , the probability the jump is to  $j$  is therefore approximately

$$q(i, j)\frac{1}{\eta}/q(i)\frac{1}{\eta} = q(i, j)/q(i) = K_{ij}.$$

We now derive an approximation for the time evolution of discrete-time Markov chains by a continuous time Markov process which has transition kernel  $P(t) := \exp(tG)$ . We start by showing the kernel  $T^\eta[\eta t] = (T^\eta)^{[\eta t]}$  which gives state probabilities of the chain after  $t$  seconds, or  $[\eta t]$  nanoseconds, is closely approximated by  $\exp(tG)$ . Obviously we have to give a meaning to  $\exp(tG)$ . Since  $G^1 = G$  and  $G^k := G \cdot G^{k-1}$ , we must simply show that the partial sums

$$\sum_{k=0}^n \frac{t^k}{k!} G^k$$

form a Cauchy sequence. We note that by the properties of the norm

$$\left\| \sum_{k=n+1}^{\infty} \frac{t^k}{k!} G^k \right\| \leq \sum_{k=n+1}^{\infty} \frac{|t|^k}{k!} \|G\|^k.$$

Since the series expansion for  $\exp(t \|G\|)$  is absolutely convergent assuming  $\|G\| < \infty$ , we see immediately that the partial sums do form a Cauchy sequence. By completeness, the limit exists and we call it  $\exp(tG)$ .

**Example 7.4 Contending processors - (7.2) continued**

We may calculate the semi-group  $P(t)$  for the generator given in Example 7.2. We need only diagonalize the matrix  $G$  into the form  $G = U^{-1}DU$  where  $D$  is a diagonal matrix whose diagonal elements are the eigenvalues of  $G$  which are 0,  $-16 - 2\sqrt{11}$  and  $-16 + 2\sqrt{11}$  (see Figure 7.1). It follows that  $G^k = U^{-1}D^kU$  where, of course,  $D^k$  is a diagonal matrix whose elements are the  $k^{th}$  powers of the

eigenvalues. Consequently  $\exp(tG) = U^{-1} \exp(tD)U$ . However

$$\begin{aligned} \exp(tD) &= \begin{pmatrix} 1 & 0 & 0 \\ 0 & \sum_{k=0}^{\infty} \frac{t^k}{k!} (-16 - 2\sqrt{11})^k & 0 \\ 0 & 0 & \sum_{k=0}^{\infty} \frac{t^k}{k!} (-16 + 2\sqrt{11})^k \end{pmatrix} \\ &= \begin{pmatrix} 1 & 0 & 0 \\ 0 & \exp(t(-16 - 2\sqrt{11})) & 0 \\ 0 & 0 & \exp(t(-16 + 2\sqrt{11})) \end{pmatrix}. \end{aligned}$$

This whole operation can be quickly done using *Mathematica* as in Figure 7.2.

```
generator={{-10, 10, 0},{4, -14, 10}, {0, 8, -8}};
{rvals,rvecs}=Eigensystem[generator];
rvals (*Display eigenvalues*)

{0, -16 - 2Sqrt[11], -16 + 2Sqrt[11]}

MatrixForm[rvecs] (*Display eigenvectors *)
```

$$\begin{pmatrix} 1 & 1 & 1 \\ \frac{15-5\text{Sqrt}[11]}{2} & 1 & \frac{-16+4\text{Sqrt}[11]}{5} \\ \frac{15+5\text{Sqrt}[11]}{2} & 1 & \frac{-16-4\text{Sqrt}[11]}{5} \end{pmatrix}$$

Fig. 7.1 Calculate the eigensystem for G.

```
u=Transpose[rvecs];
uinverse=Inverse[u];
eigendiag=DiagonalMatrix[Table[Exp[t Part [rvals,i]],{i,1,3}]];
semi=MatrixForm[N[u.eigendiag.uinverse,2]]
```

$$\begin{pmatrix} 0.15 + \frac{0.15}{2.7^{23t}} + \frac{0.69}{2.7^{9.4t}} & 0.38 - \frac{0.49}{2.7^{23t}} + \frac{0.11}{2.7^{9.4t}} & 0.47 + \frac{0.33}{2.7^{23t}} - \frac{0.8}{2.7^{9.4t}} \\ 0.15 - \frac{0.19}{2.7^{23t}} + \frac{0.044}{2.7^{9.4t}} & 0.38 + \frac{0.62}{2.7^{23t}} + \frac{0.007}{2.7^{9.4t}} & 0.47 - \frac{0.42}{2.7^{23t}} - \frac{0.051}{2.7^{9.4t}} \\ 0.15 + \frac{0.11}{2.7^{23t}} - \frac{0.26}{2.7^{9.4t}} & 0.38 - \frac{0.34}{2.7^{23t}} - \frac{0.041}{2.7^{9.4t}} & 0.47 + \frac{0.23}{2.7^{23t}} + \frac{0.3}{2.7^{9.4t}} \end{pmatrix}$$

Fig. 7.2 Calculate the semi-group  $P(t)$ .



The following theorem shows how the chain with kernel  $T^\eta$ , having generator  $G$  which evolves for  $t$  seconds or  $[\eta t]$  transitions, may be approximated by  $\exp(tG)$ .

**Theorem 7.5** *If  $T^\eta$  is the probability transition of a discrete time Markov chain with generator  $G$ , then*

$$\|T^\eta[\eta t] - \exp(tG)\| \leq \frac{2t}{\eta} \left( \|L_\eta\| + \frac{\|G\|^2}{8} \right)$$

where

$$\exp(tG) = \sum_{k=0}^{\infty} \frac{t^k}{k!} G^k.$$

The proof of the theorem is left to Section 7.6. We will first investigate  $\exp(tG)$ .

**Theorem 7.6** *Let  $G$  be a generator of a discrete-time Markov chain ( $\|G\| < \infty$ ) and let  $P(t) = \exp(tG)$ .*

**a**  *$P(t), t \geq 0$ , is a continuous semi-group of probability transition kernels on  $S$ ; that is*

(1)  $P(0) = I$

(2) *Chapman-Kolmogorov equation:*  $P_{ij}(t + s) = \sum_{k=0}^{\infty} P_{ik}(t)P_{kj}(s)$

(3)  $\lim_{h \rightarrow 0} \|P(h) - I\| = 0$

**b** *If  $\pi$  is a stationary probability measure for  $T^\eta$  then  $\pi G = \mathbf{0}$  which is equivalent to*

$$\sum_{i \in S \setminus \{j\}} \pi(i)q(i, j) = \pi(j)q(j).$$

Moreover  $\pi P(t) = \pi$  for all  $t$  so  $\pi$  is the stationary distribution for the semi-group  $P(t)$ .

**c** *The semi-group  $P(t), t \geq 0$ , satisfies Kolmogorov's backward equations:*

$$\dot{P}(t) := \frac{dP(t)}{dt} = GP(t)$$

which is equivalent to

$$\dot{P}_{ij}(t) = \sum_{k \neq i} q(i, k)P_{kj}(t) - q(i)P_{ij}(t).$$

**d** *The semi-group  $P(t), t \geq 0$ , satisfies Kolmogorov's forward equations:  $\dot{P}(t) = P(t)G$  which is equivalent to*

$$\dot{P}_{ij}(t) := \sum_{k \neq j} q(k, j)P_{ik}(t) - q(j)P_{ij}(t).$$

**Proof:** It follows from Theorem 7.5 that the components of  $T^\eta[\eta t]$  converge to those of  $P(t)$ . Hence  $P(t)$  is a probability transition kernel since  $T^\eta[\eta t]$  is. Part **a.1** follows since  $G^0 = I$ . The semi-group property, **a.2**, results from purely formal power series calculations. The details are given in the Appendix where the fact that  $G$  has a finite norm is used. Part **a.3** follows since

$$\|P(h) - I\| \leq \left\| \sum_{k=1}^{\infty} \frac{h^k}{k!} G^k \right\| \leq \sum_{k=1}^{\infty} \frac{h^k}{k!} \|G\|^k \leq \exp(h\|G\|) - 1$$

and this tends to 0 as  $h \rightarrow 0$ . By the representation (7.2) it follows that if  $\pi$  is a stationary probability measure for  $T^\eta$  then

$$\pi T^\eta = \pi + \frac{1}{\eta} \pi G + \frac{1}{\eta^2} \pi L_\eta.$$

Hence, cancelling  $\pi$  from both sides and multiplying by  $\eta$  we get

$$\pi G + \frac{1}{\eta} \pi L_\eta = \mathbf{0}.$$

Since  $\eta$  is arbitrarily small and  $\|L_\eta\|$  is bounded as  $\eta \rightarrow \infty$  it follows that  $\pi G = \mathbf{0}$ . Next

$$\begin{aligned} \pi P(t) &= \pi \sum_{k=0}^{\infty} \frac{t^k}{k!} G^k \\ &= \sum_{k=0}^{\infty} \frac{t^k}{k!} \pi G^k \\ &= \pi + \sum_{k=1}^{\infty} \frac{t^k}{k!} \mathbf{0} = \pi. \end{aligned}$$

Formal differentiation, by  $t$ , of the power series

$$\exp(tG) = \sum_{k=0}^{\infty} \frac{t^k}{k!} G^k$$

yields

$$\dot{P}(t) = \sum_{k=1}^{\infty} \frac{t^{k-1}}{(k-1)!} G^k$$

so factoring out  $G$  on the left gives  $\dot{P}(t) = GP(t)$  and on the right gives  $\dot{P}(t) = P(t)G$ . The differentiation through the summation sign follows using the dominated convergence theorem and the fact that  $\|G\| < \infty$ . ■

**Lemma 7.7** *Let  $\lambda = \sum_{i \in S} \pi(i)q(i) < \infty$  be the mean event rate and define  $\pi^K(i) = \pi(i)q(i)/\lambda$ . Then  $\pi^K$  is the stationary distribution of the embedded chain having transition kernel  $K$ .*

**Proof:** Since  $\pi G = 0$  we have  $\sum_{i \in S} \pi(i)q(i, j) = \pi(j)q(j)$ . So substituting  $q(i, j) = q(i)K_{ij}$  we get

$$\sum_{i \in S} \pi(i)q(i)K_{ij} = \pi(j)q(j).$$

Dividing by  $\lambda$  gives the result. ■

**Example 7.8 Contending processors - (7.4) continued**

The stationary probability measure satisfying

$$\pi G = (\pi(0), \pi(1), \pi(2)) \begin{pmatrix} -10 & 10 & 0 \\ 4 & -14 & 10 \\ 0 & 8 & -8 \end{pmatrix} = \mathbf{0}$$

and  $\pi(0) + \pi(1) + \pi(2) = 1$  is  $(8/53, 20/53, 25/53)$ .

We now investigate the behavior of  $P(t)$  when  $t$  tends to  $\infty$ .

**Definition 7.9** We say the generator  $G$  is irreducible if for all states  $i$  and  $j$ , there exists a smallest  $n$  and a sequence of states

$$\{i = i_0, i_1, i_2, \dots, i_n = j\}$$

such that

$$G_{i_0 i_1} G_{i_1 i_2} \cdots G_{i_{n-1} i_n} > 0.$$

**Proposition 7.10** If  $G$  is irreducible then the elements of  $P(t)$  are strictly positive for all  $t > 0$ .

**Proof.** Consider any two states  $i \neq j$  in  $S$ . The irreducibility of  $G$  means there must exist a smallest  $n$  and a sequence of states  $\{i = i_0, i_1, i_2, \dots, i_n = j\}$  such that

$$G_{i_0 i_1} G_{i_1 i_2} \cdots G_{i_{n-1} i_n} > 0.$$

Since  $n$  is assumed to be as small as possible it follows that the states  $\{i = i_0, i_1, i_2, \dots, i_n = j\}$  are disjoint. Now

$$\begin{aligned} P_{ij}(t) &= \exp(tG)_{ij} = \sum_{k=0}^{\infty} \frac{t^k}{k!} (G^k)_{ij} \\ &= \sum_{k=n}^{\infty} \frac{t^k}{k!} (G^k)_{ij} \end{aligned}$$

since  $n$  is the smallest integer such that  $G_{i_j}^n > 0$ . Hence for  $t$  small enough, the dominant term is  $(G^n)_{ij} t^n / n!$  which is positive. Hence  $P_{ij}(t) > 0$  for  $t$  small enough.

Next  $P_{ii}(t) \rightarrow 1$  as  $t \rightarrow 0$ , so  $P_{ii}(t) > 0$  for  $t$  sufficiently small. Hence for any  $t$ , by the Chapman-Kolmogorov equation,

$$P_{ij}(t) = (P(t/m))_{ij}^m \geq P_{ii}(t/m)P_{ii}(t/m) \cdots P_{ii}(t/m)P_{ij}(t/m) > 0$$

for  $m$  large enough. This gives the result. ■

**Theorem 7.11** Suppose a generator  $G$ , with  $\|G\| < \infty$ , is irreducible and  $\pi G = \mathbf{0}$  so  $\pi P(t) = \pi$ . Then

$$\lim_{t \rightarrow \infty} \sum_{j \in S} |P_{ij}(t) - \pi(j)| = 0;$$

that is, no matter what the initial state, the distribution at time  $t$  tends to the stationary distribution in total variation norm.

**Proof:** If  $G$  is irreducible then the Markov chain with kernel  $P(1)$  is irreducible by the preceding proposition. Moreover, by Theorem 7.6  $\pi P(1) = \pi$ . Therefore, by Theorem 5.26

$$\begin{aligned} \lim_{n \rightarrow \infty} \sum_{j \in S} |P_{ij}(n) - \pi(j)| &= \lim_{n \rightarrow \infty} \sum_{j \in S} |(P(1))_{ij}^n - \pi(j)| \\ &\rightarrow 0. \end{aligned}$$

Hence if  $t$  goes to infinity along the natural numbers ( $t = n$ ), the theorem holds. Now we must show the limit holds as  $t \rightarrow \infty$  arbitrarily. For any arbitrary time  $t$ , we simply take  $n$  to be the smallest integer in  $t$  ( $n \leq t < n + 1$ ) so  $P_{ij}(t) = \sum_{k \in S} P_{ik}(n)P_{kj}(t - n)$ . Hence,

$$\begin{aligned} \sum_{j \in S} |P_{ij}(t) - \pi(j)| &= \sum_{j \in S} \left| \sum_{k \in S} (P_{ik}(n)P_{kj}(t - n) - \pi(k)P_{kj}(t - n)) \right| \\ &\leq \sum_{k \in S} |P_{ik}(n) - \pi(k)| \sum_{j \in S} P_{kj}(t - n) \\ &= \sum_{k \in S} |P_{ik}(n) - \pi(k)| \rightarrow 0 \text{ as } n \rightarrow \infty. \end{aligned}$$

This gives the result. ■

### Example 7.12 Contending processors - (7.8) continued

We see from the *Mathematica* calculation in Figure 7.2 that as  $t \rightarrow \infty$  the rows of the matrix  $P(t)$  each tend to  $\pi = (8/53, 20/53, 25/53)$ . Therefore, no matter what the initial state, the probability the processors are both busy tends to  $25/53$ . This convergence is also very fast since the eigenvalues of  $G$  other than 0 are so negative. The exponential transients die out very fast in the matrix for  $P(t)$  given in Figure 7.2.

We shall construct a continuous time Markov process  $M(t)$  having transition kernel  $\exp(tG)$ . First recall from (7.4) that  $q = \max_i q(i) = \max_i [-G_{ii}]$  and define the transition kernel

$$\tilde{K}_{ii} = 1 - \frac{q(i)}{q} \text{ and } \tilde{K}_{ij} = \frac{q(i)}{q} K_{ij}, \quad i \neq j. \tag{7.5}$$

Note that  $q\tilde{K} = (qI + G)$ , so

$$\pi\tilde{K} = (1/q)\pi(q\tilde{K}) = (1/q)\pi(qI + G) = \pi + (1/q)\pi G = \pi.$$

Hence,  $\pi$  is the stationary distribution for  $\tilde{K}$ .

Next construct a Poisson process  $N(t)$  with rate  $q$ . Then construct an independent Markov chain  $J$  with kernel  $\tilde{K}$ . Define  $M(t) = J(N(t))$ . In other words at each arrival or jump of the Poisson process, perform a transition according to the kernel  $\tilde{K}$ . This is, in fact, a practical means of simulating a Markov process  $M(t)$  on a computer.

**Theorem 7.13** *The uniformized Markov Process  $M(t) = J(N(t))$  has imbedded chain  $\tilde{K}$  and transition kernel*

$$\sum_{n=0}^{\infty} e^{-qt} \frac{(qt)^n}{n!} (\tilde{K})^n = \exp(-qt + qt\tilde{K}) = \exp(tG).$$

**Proof:** We first check that this process evolves as it should:

$$\begin{aligned} P(M(t) = j | M[0] = i) &= \sum_{k=0}^{\infty} P(J[k] = j, N(t) = k | J[0] = i) \\ &= \sum_{k=0}^{\infty} P(J[k] = j | J[0] = i) P(N(t) = k) \text{ by construction} \\ &= \sum_{k=0}^{\infty} (\tilde{K})_{ij}^k \frac{(qt)^k}{k!} \exp(-qt) \\ &= \exp(tq(\tilde{K} - I))_{ij} \\ &= \exp(tG)_{ij}. \end{aligned}$$

Here we used the fact that  $I$  commutes with the matrix  $\tilde{K}$  so

$$\exp(tq\tilde{K} + (-tq)I) = \exp(tq\tilde{K}) \exp(-tqI) = \exp(-tq) \exp(tq\tilde{K}).$$

That the process is Markovian follows fairly easily. Let the past of  $M$  at  $s$  be denoted by  $\mathcal{F}_s$ , so a typical event in  $A_s \in \mathcal{F}_s$  might be defined by

$$\{N(s) = n, T_n = t_n, J_n = i_n, \dots, T_1 = t_1, J_1 = i_1, J_0 = i_0\},$$

where  $\{T_1, T_2, \dots, T_n\}$  are the arrival times of the Poisson process. Therefore, for  $t > s$ ,

$$\begin{aligned}
 P(M(t) = j | A_s) &= \sum_{k=0}^{\infty} P(M(t) = j, N(t) - N(s) = k | A_s) \\
 &= \sum_{k=0}^{\infty} P(J(n+k) = j, N(t) - N(s) = k | A_s) \\
 &= \sum_{k=0}^{\infty} (\tilde{K})_{i_n j}^k P(N(t) - N(s) = k) \\
 &= \exp((t-s)G)_{i_n j} \text{ from the above} \\
 &= P(M(t-s) = j | M(0) = i_n).
 \end{aligned}$$

Similarly,  $P(M(t) = j | M(s) = i_n) = P(M(t-s) = j | M(0) = i_n)$  so we have  $P(M(t) = j | A_s) = P(M(t) = j | M(s) = i_n)$ ; that is we have the Markov property. In conclusion then, we have shown there does indeed exist a continuous time Markov process  $M(t)$  with transition kernel  $\exp(Gt)$ . ■

The path properties of the process  $M(t)$  are exactly what one expects considering  $M(t)$  approximates the Markov chain  $X[t]$ .  $X[t]$  holds a geometric amount of time in any state  $i$  with mean  $1/q(i)$  and then jumps to state  $j$  with probability  $K_{ij}$ . We show below that  $M(t)$  has a sojourn in state  $i$  of exponential distribution with mean  $1/q(i)$  before jumping to state  $j$  with probability  $K_{ij}$ . The jump times of  $M(t)$  are defined iteratively by

$$T_n := \inf\{t > T_{n-1} : M(t) \neq M(T_{n-1})\}$$

and the  $n^{\text{th}}$  holding time is defined as  $W_n = T_{n+1} - T_n$ . In fact, we know from the construction of  $M(t)$  that a sojourn in any state  $i$  is given by the interarrival time of the Poisson process  $N(t)$ , except that fictitious jumps of  $i$  to itself are ignored. The number of fictitious jumps is geometric with mean  $q/q(i)$  by the Markov property of the chain  $J$ . Since the Poisson process has independent increments it follows that given any past of  $M(t)$  up to time  $T_n$  such that  $M(T_n) = i$ , we have  $W_n = E_1 + E_2 + \dots + E_C$ , where the  $E$ 's are interarrival times of the Poisson process  $N(t)$ , that is, independent exponential random variables with mean  $1/q$  and  $C$  is the number of jumps required until the chain jumps away from  $i$ , that is a geometric random variable with mean  $q/q(i)$ . The moment generating function of  $W_n$  can be calculated by conditioning on  $F$ : for  $|t| < q(i)$

$$E \exp\left(t \sum_{k=1}^C E_k\right) = \sum_{m=1}^{\infty} \left(1 - \frac{q(i)}{q}\right)^{m-1} \frac{q(i)}{q} \left(\frac{q}{q-t}\right)^m = \frac{q(i)}{q(i)-t}.$$

Hence  $W_n$  is exponential with mean  $1/q(i)$  as expected and  $W_n$  only depends on the current state occupied through its mean.

The above description comes in handy for identifying the generator as is seen in Example 7.15. We may also describe the transient behavior of a chain rather easily. Let  $F$  denote a set of forbidden states and let  $m(i)$  denote the mean time until the process reaches  $F$  starting from state  $i$ . Clearly  $m(i) = 0$  if  $i \in F$ . Moreover the time to reach  $F$  may be represented by  $X_i + R(J)$  where  $X_i$  represents the sojourn in state  $i$ ,  $J$  represents the state entered after the sojourn in  $i$  and  $R(J)$  represents the remaining time required to reach  $F$  after jumping to  $J$ . By the above path description

$$\begin{aligned} m(i) &= EX_i + \sum_{j \in S} P(J = j)E(R(j)|J = j) = 1/q(i) + \sum_{j \in S} K_{ij}m(j) \\ &= 1/q(i) + Km(i), \end{aligned}$$

where we have used the fact that the remaining time to reach  $F$  given we have just entered state  $j$  is independent of the past. We may rearrange this system as

$$(I - K)m(i) = \frac{1}{q(i)} \text{ for } i \in F^c \text{ and } m(i) = 0 \text{ for } i \in F. \tag{7.6}$$

If we multiply through by  $-q(i)$  and rearrange the equation for  $m$ , we have another useful form

$$Gm(i) = -1 \text{ for } i \in F^c \text{ and } m(i) = 0 \text{ for } i \in F. \tag{7.7}$$

The uniqueness of the solution to the above systems follows by contradiction. If there is another solution,  $m_1$ , to system (7.6) then the function defined by  $v(i) = m(i) - m_1(i)$  satisfies

$$Gv(i) = 0 \text{ for } i \in F^c \text{ and } v(i) = 0 \text{ for } i \in F.$$

This system satisfies a maximum principle like the one at (5.10). Since the maximum is attained at the boundary  $F$ ;  $v \leq 0$ . Applying the same reasoning to  $-v$  gives  $v \geq 0$ . Hence  $v = 0$  so the solution is unique.

**Example 7.14 Contending processors - (7.12) continued**

We might be interested in the mean time until both processors are free given both are occupied at the present time. The mean time until both processors are free starting in the three states: empty, one busy and both busy will be denoted by  $(m(0), m(1), m(2))$ . Naturally  $m(0) = 0$  and we must solve the linear system:

$$\begin{pmatrix} 4 & -14 & 10 \\ 0 & 8 & -8 \end{pmatrix} \begin{pmatrix} 0 \\ m(1) \\ m(2) \end{pmatrix} = \begin{pmatrix} -1 \\ -1 \end{pmatrix}.$$

The solution is  $(m(0), m(1), m(2)) = (0, \frac{9}{16}, \frac{11}{16})$ .

---

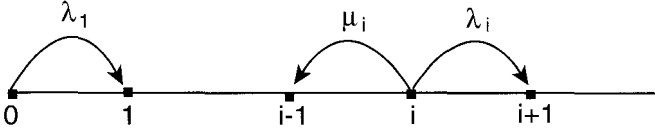

Fig. 7.3 A Birth and Death process

For a general generator  $G$  the norm is not necessarily finite. A natural example is the  $M|M|\infty$  queue! Nevertheless, the semi-group of probability transition kernels  $\exp(tG)$  may still be defined but the power series calculations needed to establish (c) and (d) in Theorem 7.6 require extra conditions. In fact the solutions to the forward and backward equations are not necessarily unique and so do not necessarily define  $\exp(tG)$ . The detailed study of such generators has led to a deeper understanding of Markov processes.

### 7.3 Queues and Time Reversal

Many problems in queueing can be reduced to the study of a continuous time Markov chain on  $S = \{0, 1, 2, \dots\}$ , with jumps to the nearest neighbour only. This gives a generator of the form

$$G = \begin{pmatrix} -\lambda_0 & \lambda_0 & 0 & 0 & \dots & 0 & \dots \\ \mu_1 & -(\lambda_1 + \mu_1) & \lambda_1 & 0 & \dots & 0 & \dots \\ \cdot & \cdot & \cdot & \cdot & \cdot & \cdot & \cdot \\ 0 & \cdot & \mu_i & -(\lambda_i + \mu_i) & \lambda_i & 0 & \cdot \\ \cdot & \cdot & \cdot & \cdot & \cdot & \cdot & \cdot \end{pmatrix}.$$

Hence  $K_{i,i-1} = \mu_i/(\lambda_i + \mu_i)$  and  $K_{i,i+1} = \lambda_i/(\lambda_i + \mu_i)$ . This means that the process sojourns in state  $i$  for an exponential amount of time with mean  $1/(\lambda_i + \mu_i)$  and then jumps either left or right to  $i - 1$  or  $i + 1$  with probabilities  $K_{i,i-1}$  or  $K_{i,i+1}$ . From state 0 we can only jump to the right so we assume  $\mu_0 = 0$ , therefore  $K_{01} = 1$ . These processes are named birth and death processes for the obvious reason that jumps from  $i$  to  $i - 1$  represent a death and jumps from  $i$  to  $i + 1$  represent a birth.

Our standing assumption  $\|G\| < \infty$  just means  $\sup\{\lambda_i + \mu_i\} < \infty$ . The kernel  $\exp(tG)$  is hard to calculate but the stationary measure  $\pi$  can easily be found. Let  $v$  be a function on  $S$  satisfying  $vG = \mathbf{0}$  so

$$\begin{aligned} -\lambda_0 v_0 + \mu_1 v_1 &= 0, \\ \lambda_{i-1} v_{i-1} - (\lambda_i + \mu_i) v_i + \mu_{i+1} v_{i+1} &= 0, \quad i \geq 1. \end{aligned}$$



Taking  $v_0 = 1$  we see by induction that

$$v_i = \frac{\lambda_0 \lambda_1 \cdots \lambda_{i-1}}{\mu_1 \mu_2 \cdots \mu_i}, \quad i \geq 1.$$

Now if  $\sum_{i=0}^{\infty} v_i < \infty$ , then the stationary distribution  $\pi$  is given by  $\pi(i) = v_i / \sum_{j=0}^{\infty} v_j < \infty$ .

**Example 7.15 The  $M|M|1$ -queue**

Consider a Poisson arrival stream of customers arriving at a single server at a rate of  $\lambda$  customers per minute. Suppose customers are served in turn with independent service times which are exponentially distributed with mean  $1/\mu$ . Let  $M(t)$  denote the number of customers in the queue at time  $t$ , including the customer being served. If a customer has just joined the queue and there are now  $i$  customers, then the duration of the sojourn in state  $i$  is the minimum between the time until the next service completion or the next arrival. Since these times are independent and exponentially distributed with means  $1/\mu$  and  $1/\lambda$ , it follows that the sojourn time in state  $i$  is also exponential with mean  $1/(\lambda + \mu)$ . Moreover, the probability the process jumps next to state  $i + 1$  is simply the probability the next arrival comes before the service completion and this is  $\lambda/(\lambda + \mu)$ . It follows that  $M$  is a continuous time Markov process with state space  $S = \{0, 1, 2, \dots\}$ , whose generator is that of a birth and death process with constant birth and death rates.

From the above, the stationary distribution is given by

$$\pi(i) = (1 - \rho)\rho^i \text{ where } \rho = \frac{\lambda}{\mu}.$$

$\rho = \lambda/\mu$  is called the load on the system and it is clear  $\rho$  must be less than 1 or else no stationary distribution exists because  $\sum \pi(i)$  would be infinite. This is no surprise because customers are arriving at a rate of  $\lambda$  per second and, on average, each customer generates  $1/\mu$  seconds of work at the server. Hence work is arriving at the server at rate of  $\rho = \lambda/\mu$  seconds of work per second. The server does at most one second of work per second so if the load is greater than 1 then customers are arriving faster than they can be served and the queue must explode.

For a general birth and death process we may consider a forbidden set of states  $F := \{\ell, \ell + 1, \dots\}$ . The mean time  $m(i)$  to reach the forbidden set from  $i < \ell$  is the same as the mean time to hit  $\ell$ . The function  $m$  satisfies (7.7) which means  $m(i) = 0$  for  $i \geq \ell$  and

$$m(i) = 1/q(i) + \left( \frac{\mu_i}{\lambda_i + \mu_i} m(i - 1) + \frac{\lambda_i}{\lambda_i + \mu_i} m(i + 1) \right) \tag{7.8}$$

for  $0 < i < \ell$ . If we define

$$M(i) := \sum_{j=0}^i \pi(j) \quad \text{and} \quad \nu(i) := \sum_{j=0}^{i-1} \frac{M(j)}{\lambda_j \pi(j)},$$

where  $\nu(0)$  is equal to 0, then we see  $m(i) = \nu(\ell) - \nu(i)$  by substitution in (7.8).

**Example 7.16 The  $M|M|1$ -queue - (7.15) continued**

Since  $\pi(j) = (1 - \rho)\rho^j$  it follows by summing the geometric sequence that  $M(i) = 1 - \rho^{i+1}$ . Next for  $j > 0$

$$\begin{aligned} \nu(j) &= \sum_{k=0}^{j-1} \frac{1 - \rho^{k+1}}{\lambda(1 - \rho)\rho^k} \\ &= \frac{\rho}{\lambda(1 - \rho)^2} [\rho^{-j} - j(1 - \rho) - 1]. \end{aligned}$$

It follows, for instance, that the mean time for the  $M|M|1$ -queue to reach level  $\ell$ , starting from an empty queue, is

$$m(0) = \nu(\ell) \sim \frac{\rho}{\lambda(1 - \rho)^2} \frac{1}{\rho^\ell} = \frac{\rho}{\lambda(1 - \rho)} \frac{1}{\pi(\ell)}.$$

Similarly, the mean time to overload the  $M|M|1$ -queue from any initial queue can be calculated from the formula  $m(i) = \nu(\ell) - \nu(i)$ .

Consider a stationary continuous time Markov process  $\{M(t); 0 \leq t \leq T\}$  on a countable state space  $S$  having stationary probability measure  $\pi$  and transition rates  $q(i, j)$  for  $i, j \in S$ . If we fix any time  $T$ , we may consider the time reversal of the original process,  $\{M^*(t) = M(T - t); 0 \leq t \leq T\}$ , still defined on the same probability space. For *stationary* Markov processes the situation is the same as for Markov chains: the time reversal is again a Markov process. To show this, recall that  $P(t)$  denotes the semi-group of the forward process with generator  $G$ . Construct a new semi-group with generator  $G_{ij}^* = \pi(j)G_{ji}/\pi(i)$ . That this is indeed a generator follows since the matrix  $G^*$  is negative only for diagonal elements and

$$\sum_{j \in S} G_{ij}^* = \sum_{j \in S} \frac{\pi(j)G_{ji}}{\pi(i)} = 0$$

since  $\pi$  is the stationary distribution so  $\pi G = \mathbf{0}$ . By matrix multiplication it follows

that

$$\begin{aligned}
 (G^*)_{ij}^k &= \sum_{i_1, i_2, \dots, i_{k-1} \in S} G_{ii_1}^* G_{i_1 i_2}^* \cdots G_{i_{k-1} j}^* \\
 &= \sum_{i_1, i_2, \dots, i_{k-1} \in S} \frac{\pi(i_1) G_{i_1 i} G_{i_2 i_1} \cdots \pi(j) G_{j i_{k-1}}}{\pi(i) \pi(i_1) \cdots \pi(i_{k-1})} \\
 &= \sum_{i_1, i_2, \dots, i_{k-1} \in S} \frac{\pi(j)}{\pi(i)} G_{j i_{k-1}} \cdots G_{i_2 i_1} G_{i_1 i} \\
 &= \frac{\pi(j)}{\pi(i)} (G^k)_{ji}.
 \end{aligned}$$

Moreover the semi-group associated with  $G^*$  is

$$P_{ij}^*(t) := \sum_{k=0}^{\infty} \frac{t^k (G^*)_{ij}^k}{k!} = \sum_{k=0}^{\infty} \frac{\pi(j)}{\pi(i)} \frac{t^k (G^k)_{ji}}{k!} = \frac{\pi(j)}{\pi(i)} P_{ji}(t)$$

using the above expression for  $(G^*)^k$ . The following theorem shows that  $P^*$  is the semi-group of the transitions of the process  $M^*$  and consequently,  $M^*$  really is a Markov process.

**Theorem 7.17** *The time reversed process  $\{M^*(t) := M(T - t); 0 \leq t \leq T\}$  is a stationary Markov process with stationary distribution  $\pi$ , semi-group  $P_{ij}^*(t) = \pi(j)P_{ji}(t)/\pi(i)$  and transition rates*

$$q^*(i, j) = \frac{\pi(j)q(j, i)}{\pi(i)}$$

or, what is equivalent, generator  $G_{ij}^* = \pi(j)G_{ji}/\pi(i)$ .

**Proof:** It suffices to show that the joint distribution of the time reversed process

viewed at times  $0 \leq t_1 < t_2 < \dots < t_n \leq T$  is that of a Markov process.

$$\begin{aligned}
 & P(M^*(t_1) = i_1, M^*(t_2) = i_2, \dots, M^*(t_n) = i_n) \\
 &= P(M(T - t_1) = i_1, M(T - t_2) = i_2, \dots, M(T - t_n) = i_n) \\
 &= P(M(T - t_n) = i_n, M(T - t_{n-1}) = i_{n-1}, \dots, \\
 &\quad M(T - t_2) = i_2, M(T - t_1) = i_1) \\
 &= \pi(i_n) P_{i_n i_{n-1}}((T - t_{n-1}) - (T - t_n)) \\
 &\quad \cdot P_{i_{n-1} i_{n-2}}((T - t_{n-2}) - (T - t_{n-1})) \cdots \\
 &\quad P_{i_2 i_1}((T - t_1) - (T - t_2)) \\
 &= \pi(i_n) P_{i_n i_{n-1}}(t_n - t_{n-1}) P_{i_{n-1} i_{n-2}}(t_{n-1} - t_{n-2}) \cdots P_{i_2 i_1}(t_2 - t_1) \\
 &= \frac{\pi(i_n) P_{i_n i_{n-1}}(t_n - t_{n-1}) \pi(i_{n-1}) P_{i_{n-1} i_{n-2}}(t_{n-1} - t_{n-2}) \cdots}{\pi(i_{n-1}) \pi(i_{n-2})} \dots \\
 &\quad \frac{\pi(i_2) P_{i_2 i_1}(t_2 - t_1)}{\pi(i_1)} \pi(i_1) \\
 &= P_{i_{n-1} i_n}^*(t_n - t_{n-1}) P_{i_{n-2} i_{n-1}}^*(t_{n-1} - t_{n-2}) \cdots P_{i_1 i_2}^*(t_2 - t_1) \pi(i_1) \\
 &= \pi(i_1) P_{i_1 i_2}^*(t_2 - t_1) \cdots P_{i_{n-2} i_{n-1}}^*(t_{n-1} - t_{n-2}) P_{i_{n-1} i_n}^*(t_n - t_{n-1}).
 \end{aligned}$$

It follows that the process  $M^*$  does evolve like a Markov process with transition kernel  $P^*$ , at least between a fixed finite set of observation times  $0 \leq t_1 < t_2 < \dots < t_n \leq T$ . Hence  $M^*$  is Markov at least down to the nanoseconds. The result also holds in continuous time, but it requires a little measure theory to show the probability induced by  $M^*$  on the set of continuous time trajectories in the state space  $S$ , is determined by the probability of sets of trajectories determined at a fixed finite number of time points like  $0 \leq t_1 < t_2 < \dots < t_n \leq T$ . ■

We next state an innocuous little lemma which is the key to this section.

**Lemma 7.18 (Kelly's Lemma)** *Let  $\{M(t); 0 \leq t \leq T\}$  be a stationary Markov process with transition rates  $q(i, j)$  for  $i, j \in S$ . Suppose we can invent a non-negative matrix  $\{q^*(i, j); i, j \in S\}$  and a non-negative vector  $\{\pi(j) : j \in S\}$  whose components sum to 1 such that*

$$q^*(i) = q(i) \text{ where } q(i) := \sum_{j \in S \setminus \{i\}} q(i, j), \quad q^*(i) := \sum_{j \in S \setminus \{i\}} q^*(i, j) \quad (7.9)$$

and such that

$$\pi(i)q(i, j) = \pi(j)q^*(j, i) \text{ for } i, j \in S, j \neq i. \quad (7.10)$$

Then  $\{q^*(i, j); i, j \in S, j \neq i\}$  are the transition rates of the time reversed process  $\{M(T - t); 0 \leq t \leq T\}$  and, **more importantly**,  $\{\pi(j) : j \in S\}$  is the equilibrium distribution for both processes.

**Proof:** By equation (7.10) we have

$$\begin{aligned} \sum_{i \in S \setminus \{j\}} \pi(i)q(i, j) &= \sum_{i \in S \setminus \{j\}} \pi(j)q^*(j, i) \\ &= \pi(j) \sum_{i \in S \setminus \{j\}} q^*(j, i) \\ &= \pi(j)q^*(j) \\ &= \pi(j)q(j) \text{ by (7.9)}. \end{aligned}$$

Therefore by part (b) of Theorem 7.6,  $\pi$  is the stationary measure for  $M(t)$ . Repeating the argument shows  $\sum_{j \in S \setminus \{i\}} \pi(j)q^*(j, i) = \pi(i)q^*(i)$  so  $\pi$  is also the stationary measure for the Markov process with transition rates  $q^*(j, i)$ . By Theorem 7.17 we see  $q^*(i, j)$  gives the transition rates for the time reversed process  $\{M(T - t); 0 \leq t \leq T\}$ . ■

The transition rates of the time reversal of a stationary birth and death process are given by  $q^*(i, i + 1) = \pi(i + 1)\mu_{i+1}/\pi(i) = \lambda_i$  and for  $i > 0$ ,  $q^*(i, i - 1) = \pi(i - 1)\lambda_{i-1}/\pi(i) = \mu_i$ . In other words the process evolves according to the same stochastic mechanism when regarded backward in time! We call such processes reversible.

**Example 7.19 The  $M|M|1$ -queue - (7.16) continued**

The implication of the reversibility of the  $M|M|1$ -queue is quite striking. Fix a time  $T$ . Relative to time  $T$ , the past departures from the forward queue are future arrivals of the time reversed process since when the forward process decreases by one, the time reversed process increases by one. However the future arrival times of the time reversed process are those of a Poisson process with rate  $\lambda$  and are independent to the current number of customers in the queue at time  $T$  since the time reversed process is an  $M|M|1$ -queue. We conclude, the past departure times of the forward process are those of a Poisson process with rate  $\lambda$  and are independent of the current number of customers in the queue.

We must quickly point out, however, that the current number of customers in the queue does influence the future departure process. If in fact there are no customers in the queue none is likely to depart! First one must wait for an arrival and then a service. The mean time until this occurs is  $1/\lambda + 1/\mu$  while the mean time for a Poisson arrival to occur is  $1/\lambda$ . Nevertheless, on average, the input and output of an  $M|M|1$ -queue is a Poisson process of the same rate. This has important consequences when we make a network of such queues.

---

**Example 7.20  $M|M|1$  multiclass queues**

Imagine a machine tool in a factory which performs a particular operation like soldering a chip to a circuit board. Imagine that a finite number of different classes,  $C$ , of boards arrive at the machine according to independent Poisson processes with rates  $\lambda^c$  where  $c \in C$ . The boards are serviced on a first in first out basis (FIFO).

We assume we can speed up service depending on the number of boards in the queue, so when  $n$  are present, the service time is exponential with mean  $1/\mu_n$ . Let  $\lambda = \sum_{c \in C} \lambda^c$ .

If there are  $n$  boards in the queue at any time  $t$ , we describe the state of the system by the vector

$$\vec{x} = (x_1, x_2, \dots, x_n)$$

where  $x_1$  is the class of the first board in the queue (actually being served),  $x_2$  is the class of the second board in the queue and so on. The arrival of a new board of class  $c$  causes a transition to a new state  $A^c \vec{x} = (x_1, x_2, \dots, x_n, c)$  with a rate

$$q(\vec{x}, A^c \vec{x}) = \lambda^c.$$

The completion of a board causes a transition to the state  $D\vec{x} = (x_2, \dots, x_n)$  with a rate

$$q(\vec{x}, D\vec{x}) = \mu_n.$$

Define

$$\pi(\vec{x}) = f \prod_{k=1}^n \frac{\lambda^{x_k}}{\mu_k}$$

where we assume

$$f^{-1} = \sum_{n=0}^{\infty} \prod_{k=1}^n \rho_k < \infty \text{ and } \rho_k := \lambda/\mu_k.$$

The factor  $f$  makes  $\pi$  a probability as is seen below.

Let's calculate the probability the queue contains  $n$  boards. Summing over all possible queues containing  $n$  boards, we get

$$\sum_{x_1 \dots x_n} \pi(\vec{x}) = f \sum_{x_1 \dots x_n} \prod_{k=1}^n \frac{\lambda^{x_k}}{\mu_k} = f \prod_{k=1}^n \left( \sum_{x_k} \frac{\lambda^{x_k}}{\mu_k} \right) = f \prod_{k=1}^n \rho_k.$$

The probability there are no boards in the queue is  $f$ . Now summing  $n$  from 0 to  $\infty$  we must get 1 and the definition of  $f$  makes this work out:

$$\sum_{n=0}^{\infty} f \prod_{k=1}^n \rho_k = 1 \text{ by definition.}$$

Hence  $\pi$  is a probability and we show below that  $\pi$  is the steady state for this  $M|M|1$  multiclass queue.

Before doing so, however, we remark that, given the number of boards in the queue, the positions of the queue are independent. For example, given there are 2

boards in the queue, the probability the first position has a class  $c$  board and the second has a class  $d$  board is

$$\frac{f(\lambda^c/\mu_1)(\lambda^d/\mu_2)}{f\rho_1\rho_2} = \frac{\lambda^c}{\lambda} \frac{\lambda^d}{\lambda}.$$

This is clearly a product measure so the classes of the two boards are independent.

The trick to proving  $\pi$  is the steady state is to guess the transition rates of the time reversed process. Intuitively this process should have departures from the end of the queue and arrivals should come at the front of the queue. Suppose  $\vec{x} = (x_1, x_2, \dots, x_n)$  and  $x_1 = d$ . By time reversal, the transition rates of the time reversed process should be

$$q^*(A^c\vec{x}, \vec{x}) = \frac{\pi(\vec{x})}{\pi(A^c\vec{x})} q(\vec{x}, A^c\vec{x}) = \frac{1}{\lambda^c/\mu_{n+1}} \lambda^c = \mu_{n+1}$$

and

$$\begin{aligned} q^*(D\vec{x}, \vec{x}) &= \frac{\pi(\vec{x})}{\pi(D\vec{x})} q(\vec{x}, D\vec{x}) \\ &= \frac{f(\lambda^d/\mu_1)(\lambda^{x_2}/\mu_2) \cdots (\lambda^{x_n}/\mu_n)}{f(\lambda^{x_2}/\mu_1)(\lambda^{x_3}/\mu_2) \cdots (\lambda^{x_n}/\mu_{n-1})} \cdot \mu_n = \lambda^d. \end{aligned}$$

Hence, departures occur at rate  $\mu_n$  if there are  $n$  boards in the queue and arrivals of class  $d$  occur at rate  $\lambda^d$ , just like for the forward time process. Next,

$$q^*(\vec{x}) = \mu_n + \sum_{d \in C} \lambda^d = \mu_n + \lambda = q(\vec{x})$$

as long as the queue is nonempty.  $q^*(\vec{x}) = \sum_{c \in C} \lambda^c = \lambda = q(\vec{x})$  if it is empty. The conditions

$$\pi(A^c\vec{x})q^*(A^c\vec{x}, \vec{x}) = \pi(\vec{x})q(\vec{x}, A^c\vec{x}) \text{ and } \pi(D\vec{x})q^*(D\vec{x}, \vec{x}) = \pi(\vec{x})q(\vec{x}, D\vec{x})$$

are automatic from the definition.

We have therefore verified the conditions of Kelly's Lemma and we conclude we have correctly guessed the transition rates of the time reversed process and that  $\pi$  is the stationary distribution. In fact we have shown more since the transition rates of the time reversal are the same as the forward process. We might even think the process is reversible! This is not quite true because the time reversed process receives new boards at the beginning of the queue and serves them from the end. Modulo this mirror reflection of the queue, the two queues evolve according to the same rates. We say this queue is dynamically reversible. As in the  $M|M|1$  example, we may therefore conclude that, when this Markov process is in equilibrium, the departure processes of the various classes are independent Poisson processes and their past up to any time  $t$  is independent of the state at time  $t$ . Stationary queues having classes with independent Poisson arrivals whose departure processes are also independent Poisson processes having a past independent of the current state are called quasi-reversible queues.

If the service rate is a constant  $\mu$ , then  $f = 1 - \rho$  where  $\rho := \lambda/\mu$ . Hence the queue is stable only if  $\rho < 1$ . This means the load or average amount of work arriving per unit time is less than the service rate, so the queue should not overload. Moreover, if  $\vec{x} = (x_1, x_2, \dots, x_n)$ , then

$$\pi(\vec{x}) = (1 - \rho)\rho^n \prod_{k=1}^n \frac{\lambda^{x_k}}{\lambda}. \quad (7.11)$$

Summing over the various classes of customers we see the probability of having  $n$  customers in the queue is  $(1 - \rho)\rho^n$ .

It would have been nice if the service rate could depend on the class of the customer being served! Denote the departure of a class  $c$  customer by  $D^c$  then if  $\vec{x} = (x_1, x_2, \dots, x_n)$  and  $x_1 = c$  then  $q(\vec{x}, D^c\vec{x}) = \mu_n^c$ . We can, of course write down the equilibrium equations:

$$\pi(\vec{x})[\lambda + \mu_n^c] = \sum_d \pi(A^d\vec{x})\mu_{n+1}^d + \pi(D^c\vec{x})\lambda^c.$$

However, it is clear that if a class  $c$  customer has a very slow service rate, it will leave behind a relatively long queue. Hence the present state of the queue will not be independent of past departures!

---

## 7.4 Jackson Networks

A Jackson network consists of  $m$  nodes each having a server and a first-in, first-out queue of customers. Customers arrive from outside the network according to independent Poisson processes and the arrival rate at node  $i$  is  $\bar{\lambda}_i$ . The service times at node  $i$  are exponential with a rate  $\mu_i$ . When a service is completed at node  $i$  the customer moves with a fixed probability  $r_{ij}$  to node  $j \in \{1, \dots, m\}$ , or else leaves the system with probability  $r_i = 1 - \sum_j r_{ij}$ . We say the network is open if a customer at any node  $k$  can leave the network possibly via transitions to other nodes. By the memoryless property of the exponential distribution, the state space of the Jackson network can be simply a vector  $(x_1, x_2, \dots, x_m)$ , where  $x_i$  denotes the number of customers waiting or being served at node  $i$ .

There are many extensions of this model. The service rate might depend on the number of customers in the queue or in all the queues. Customers may be classified as requiring a specified sequence of service delivered by a prescribed sequence of nodes in the network. A more intractable model might require the transition probabilities  $r_{ij}$  to depend on the current state of the network; i.e. don't send customers to node  $j$  if  $j$  is too busy. We shall restrict ourselves to the above simple open Jackson network and shall shortly see it's not so simple!

We first find the stationary distribution of a Jackson network and the solution is very elegant. If one defines the rate at which customers arrive at node  $j$  on average



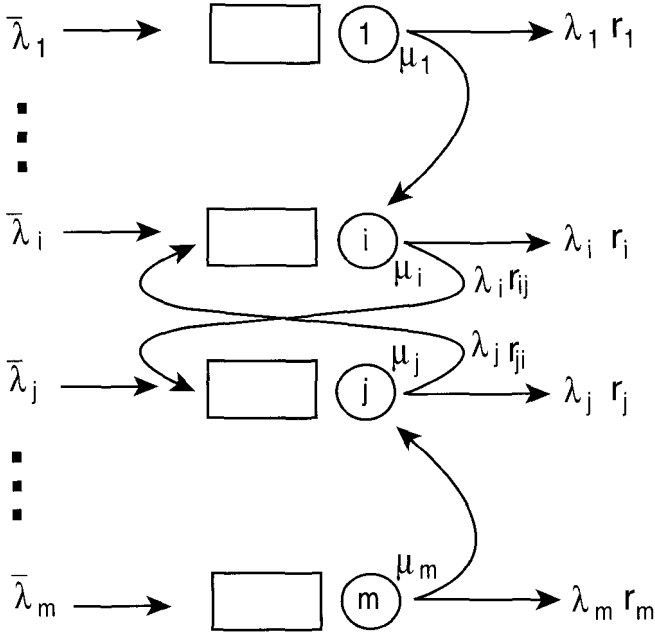

Fig. 7.4 An open Jackson network

to be  $\lambda_j$ , it follows intuitively that this rate should satisfy the flow equation

$$\lambda_j = \bar{\lambda}_j + \sum_i \lambda_i r_{ij} \tag{7.12}$$

since the proportion of the flow  $\lambda_i$  into node  $i$  which flows next to node  $j$  is  $r_{ij}$ . Now viewing the node  $j$  in isolation and bearing in mind the previous results that the output of the  $M|M|1$ -queue at node  $i$  is a Poisson process with rate  $\lambda_i$ , it is reasonable to assume the input to node  $j$  is the sum of incoming Poisson processes and hence the input is Poisson with rate  $\lambda_j$  because of (7.12). Consequently, viewed in isolation node  $j$  should be an  $M|M|1$ -queue and this we know has stationary distribution  $\pi_j(x) = (1-\rho_j)\rho_j^x$ . The nicest possible result then is true; the stationary distribution  $\pi$ , of the whole Jackson network has a *product form*

$$\pi(x_1, x_2, \dots, x_m) = \pi_1(x_1)\pi_2(x_2) \cdots \pi_m(x_m).$$

This means that at a fixed time the number of customers at any node is independent of the numbers at other nodes and the distribution is that of a stationary  $M|M|1$ -queue.

This remarkable result follows by using Kelly's Lemma. We shall in fact show the

time reversed process of the Jackson network is another Jackson network with the same service rates and the same stationary distribution. Let the operator  $A_i$  applied to a state  $\vec{x} = (x_1, x_2, \dots, x_i, \dots, x_m)$  denote the transition from the state  $\vec{x}$  to the state  $A_i(\vec{x})$  given by  $(x_1, x_2, \dots, x_i + 1, \dots, x_m)$ ; that is an arrival has occurred at node  $i$ . Similarly let the operator  $D_i$ , applied to a state  $\vec{x}$  denote the transition to the state  $D_i(\vec{x}) = (x_1, x_2, \dots, x_i - 1, \dots, x_m)$ ; that is a departure has occurred at node  $i$  and the customer leaves the system. Finally, let  $T_{ij}$  applied to a state  $\vec{x}$  denote the transition to the state  $T_{ij}(\vec{x}) = (x_1, x_2, \dots, x_i - 1, \dots, x_j + 1, \dots, x_m)$ ; that is a departure has occurred at node  $i$  and the customer has entered the queue at node  $j$ .

Let  $\mu_i(x_i) = \mu_i$  if  $x_i > 0$  and 0 otherwise. Hence the transition rates are

$$\begin{aligned} q(\vec{x}, A_i(\vec{x})) &= \bar{\lambda}_i \\ q(\vec{x}, D_i(\vec{x})) &= \mu_i(x_i)r_i. \\ q(\vec{x}, T_{ij}(\vec{x})) &= \mu_i(x_i)r_{ij}. \end{aligned}$$

If the time reversed process is indeed a Jackson network with the same service rates and  $\pi$  is indeed the stationary distribution, then the arrival rate to node  $i$  from the outside of the network for the time reversed process should be

$$\begin{aligned} \bar{\lambda}_i^* &:= q^*(\vec{x}, A_i(\vec{x})) \\ &= \frac{\pi(A_i(\vec{x}))}{\pi(\vec{x})} q(A_i(\vec{x}), \vec{x}) \\ &= \frac{\pi_i(x_i + 1)}{\pi_i(x_i)} q(A_i(\vec{x}), \vec{x}) \\ &= \frac{\lambda_i}{\mu_i} \mu_i r_i = \lambda_i r_i. \end{aligned}$$

Similarly, the departure rate from node  $i$  to outside the network for the time reversed process should be (when  $x_i > 0$ )

$$\begin{aligned} \mu_i^* r_i^* &:= q^*(\vec{x}, D_i(\vec{x})) \\ &= \frac{\pi(D_i(\vec{x}))}{\pi(\vec{x})} q(D_i(\vec{x}), \vec{x}) \\ &= \frac{\mu_i}{\lambda_i} \bar{\lambda}_i. \end{aligned}$$

Since the service rates of the time reversed Jackson network are the same we conclude  $r_i^*$  must equal  $\bar{\lambda}_i/\lambda_i$ .

Finally, the transition rate from node  $i$  to node  $j$  (when  $x_i > 0$ ) for the time

reversed process should be

$$\begin{aligned} \mu_i^* r_{ij}^* &:= q^*(\vec{x}, T_{ij}(\vec{x})) \\ &= \frac{\pi(T_{ij}(\vec{x}))}{\pi(\vec{x})} q(T_{ij}(\vec{x}), \vec{x}) \\ &= \frac{\mu_i}{\lambda_i} \frac{\lambda_j}{\mu_j} \mu_j r_{ji} \\ &= \mu_i \frac{\lambda_j r_{ji}}{\lambda_i}. \end{aligned}$$

Again since we are supposing the service rates of the time reversed Jackson network are the same, we conclude  $r_{ij}^*$  must be equal to  $\lambda_j r_{ji} / \lambda_i$ . This is consistent since by summation,

$$r_i^* = 1 - \sum_j r_{ij}^* = 1 - \sum_j \lambda_j r_{ji} / \lambda_i = 1 - (\lambda_i - \bar{\lambda}_i) / \lambda_i = \bar{\lambda}_i / \lambda_i.$$

To use Kelly’s Lemma, we need only show (7.9) and (7.10). The second is true by construction. Since  $q(\vec{x}) = \sum_i (\bar{\lambda}_i + \mu_i \cdot \chi\{x_i \neq 0\})$  and

$$\begin{aligned} q^*(\vec{x}) &= \sum_i \left( \bar{\lambda}_i^* + \mu_i \cdot \chi\{x_i \neq 0\} \right) \\ &= \sum_i (\lambda_i r_i + \mu_i \cdot \chi\{x_i \neq 0\}), \end{aligned}$$

(7.9) follows from the flow equation

$$\begin{aligned} \sum_i \bar{\lambda}_i &= \sum_i \lambda_i - \sum_i \sum_j \lambda_j r_{ji} \\ &= \sum_i \lambda_i - \sum_j \lambda_j (1 - r_j) = \sum_i \lambda_i r_i. \end{aligned}$$

We conclude the time reversed Jackson network is another Jackson network with the same stationary distribution  $\pi$ . It follows, moreover, that the solution of the flow equations for the time reversed process gives flows  $\lambda_i^* = \lambda_i$ , in order that the stationary distributions be the same.

We have arrived at a very satisfactory description of the network in steady state but let’s not get carried away. The number of customers at node  $i$ , at time  $t$ , may be independent of the number of customers at the other nodes *at time  $t$*  but it certainly influences the future evolution of the other nodes! If node  $i$  has lots of customers, it will drive the other nodes as fast as it can serve customers; that is the flow into node  $j$  say will have rate  $\mu_i r_{ij}$  not  $\lambda_i r_{ij}$ ! If the service rate  $\mu_j$  at node  $j$  is close to  $\lambda_j$  it may well be that this extra flow from node  $i$  will overcome the service rate at node  $j$  and it will start to fill as well. This transient behavior is crucial for designing the network but is not well understood at present.

## 7.5 Kelly or BCMP Networks

Imagine that a factory has  $J$  machine tools like that in Example 7.20, each one of which performs a specific operation. Now imagine that the factory produces many different kinds of circuit boards each requiring a series of operations performed by the machine tools. In fact if one tool solders on resistors it may be necessary for the same board to revisit the same machine tool several times at different phases of its construction cycle. The new boards may in principle start their cycle at any of the machine tools and finish at any machine tool.

To model this factory we consider  $J$  FIFO  $M|M|1$  multitype queues representing the  $J$  machine tools. New circuit boards of class  $c$  arrive on the shop floor at queue  $i$  according to a Poisson process with rate  $\bar{\lambda}^c(i)$ . These new boards join the queue at that machine. All classes of boards are serviced at a rate which may depend on the number of boards in the queue. Hence if there are  $n$  boards at machine  $i$ , then the service rate is  $\mu_n(i)$ . When a board of class  $c$  leaves queue  $i$  it is sent to queue  $j$  and changes to class  $d$  with probability  $r_{ij}^{cd}$ . With probability  $r_i^c := 1 - \sum_{jd} r_{ij}^{cd}$  the board leaves the factory. Such a scheme is called Markov routing.

These routing probabilities from one machine are independent of the state of the other machines in the network so we can't reroute a board if the destination machine is too busy. Moreover we are assuming the queues are FIFO  $M|M|1$  multitype queues and this means each of the classes of board has the same service time distribution and we can't give priority to different types of boards. This makes the model a little unrealistic. On the other hand this model is quite powerful. Suppose one kind of board must visit machines  $(i, j, i, k, j, i)$  in that order. Define a class  $c_1$  to be this kind of board at its first visit to machine  $i$ . Define  $c_2$  to be the class of this board at the second stage of its route, i.e. at machine  $j$ . Define  $c_3$  to be the class of this board at the third stage of its route, i.e. at machine  $i$  for the second time. Continuing in this way we describe the route of the board by a sequence of changes of class and the class of the board completely describes its current stage on its route. Naturally  $r_{ij}^{c_1 c_2} = 1$ ,  $r_{ji}^{c_2 c_3} = 1$ ,  $r_{ik}^{c_3 c_4} = 1$  and so on. Also,  $\bar{\lambda}^{c_1}(i) > 0$  while  $\bar{\lambda}^{c_2}(j) = 0$ ,  $\bar{\lambda}^{c_3}(i) = 0$  since the boards start out in class  $c_1$  and do not enter the system otherwise. Consequently, if we allow ourselves a large number of classes, this model incorporates a detailed description of the flow of boards through the network and the calculation of queue sizes at the different machines has a definite interest. Surprisingly, this is possible and in fact the best possible answer is true. The stationary distribution of the network is the product of the stationary distributions of the individual queues taken in isolation just like the Jackson network.

The state of the network is described by

$$\hat{x} := (\vec{x}_1, \vec{x}_2, \dots, \vec{x}_J)$$

where  $\vec{x}_i$  is the state of queue  $i$  as defined in Example 7.20. If the current state is  $\hat{x}$

and a new board of class  $c$  arrives from outside the network to queue  $i$ , we denote the new state of the network by  $A_i^c \hat{x}$ . If a class  $c$  board departs the network from queue  $i$ , we denote the new state by  $D_i^c \hat{x}$ . Finally, if a class  $c$  board has been served at queue  $i$  and is transferred to queue  $j$  as a class  $d$  board, we denote the new state by  $T_{ij}^{cd} \hat{x}$ . If there are  $\ell(i)$  boards in queue  $i$ , the transition rates of the network are given by

$$\begin{aligned} q(\hat{x}, A_i^c \hat{x}) &= \bar{\lambda}^c(i) \\ q(\hat{x}, T_{ij}^{cd} \hat{x}) &= \mu_{\ell(i)}(i) r_{ij}^{cd} \\ q(\hat{x}, D_i^c \hat{x}) &= \mu_{\ell(i)}(i) r_i^c. \end{aligned}$$

The stationary distribution  $\pi(i)$  of queue  $i$  as given in Example 7.20 depends on the arrival rates of the various classes. The total arrival rate of class  $c$  boards must be the sum of the arrival rate from outside the factory plus the arrival rates from other machine tools. In other words, the arrival rate of class  $c$  boards at queue  $i$ , which we call  $\lambda^c(i)$ , must satisfy the flow conservation equations:

$$\lambda^c(i) = \bar{\lambda}^c(i) + \sum_{j \in J} \sum_{d \in C} \lambda^d(j) r_{ji}^{dc}.$$

We shall assume we have a solution to this linear system. Also note that

$$\begin{aligned} \sum_{ic} \lambda^c(i) r_i^c &= \sum_{ic} \lambda^c(i) \left( 1 - \sum_{jd} r_{ij}^{cd} \right) \\ &= \sum_{ic} \lambda^c(i) - \sum_{jd} \sum_{ic} \lambda^c(i) r_{ij}^{cd} \\ &= \sum_{ic} \lambda^c(i) - \sum_{jd} \left( \lambda^d(j) - \bar{\lambda}^d(j) \right) \\ &= \sum_{ic} \lambda^c(i) - \sum_{ic} \left( \lambda^c(i) - \bar{\lambda}^c(i) \right) \\ &= \sum_{ic} \bar{\lambda}^c(i). \end{aligned} \tag{7.13}$$

To show just how easy it is to give the steady state of a Kelly network, consider the following example.

**Example 7.21 Solving a small Kelly network**

Imagine a factory with three machines, as in Figure 7.5. Number 1 prints a circuit on a board. Number 2 solders connections and number 3 staples in IC's (integrated circuits). The factory has two products, widgets and gadgets. Widget boards arrive at machine 1 according to a Poisson process at a rate of one a minute while gadget boards arrive at machine 1 according to another independent process at a rate of two per minute.

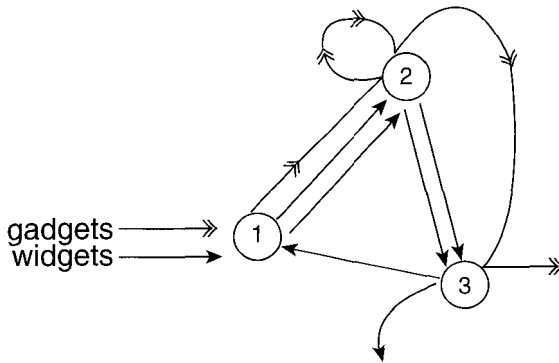

Fig. 7.5 A network of multitype queues.

A widget board visits machines 1, 2 and 3 in that order twice and then is finished. Call a widget board class  $a$  if it is on its first pass through 1, 2 and 3 and class  $b$  if it is on its second pass. The flows of widgets through the queues is described by  $\lambda^a(1)$ ,  $\lambda^a(2)$ ,  $\lambda^a(3)$  and  $\lambda^b(1)$ ,  $\lambda^b(2)$ ,  $\lambda^b(3)$ . Each of these flows is equal to  $\bar{\lambda}^a(1) = 1$  by the flow conservation equations.

A gadget board visits machine 1 then machine 2 twice to avoid overheating the board by doing too much soldering in one pass. The gadget board then visits machine 3 and then is finished. Call a gadget board class  $c$  before the second visit to machine 2 and class  $d$  after. The flows of gadgets through the queues is described by  $\lambda^c(1)$ ,  $\lambda^c(2)$ ,  $\lambda^d(2)$  and  $\lambda^d(3)$ . Each of these flows is equal to  $\bar{\lambda}^c(1) = 2$  by the flow conservation equations.

Suppose that the service rates at machines 1, 2 and 3 are  $\mu_1 = 5$ ,  $\mu_2 = 10$  and  $\mu_3 = 5$  respectively, independent of the queue sizes. We suppose the queues are FIFO. The total flow into queues 1, 2 and 3 are

$$\begin{aligned}\lambda(1) &= \lambda^a(1) + \lambda^b(1) + \lambda^c(1) = 4 \\ \lambda(2) &= \lambda^a(2) + \lambda^b(2) + \lambda^c(2) + \lambda^d(2) = 6 \\ \lambda(3) &= \lambda^a(3) + \lambda^b(3) + \lambda^d(3) = 4.\end{aligned}$$

Hence the loads on queues 1, 2 and 3 are  $\rho_1 = 4/5$ ,  $\rho_2 = 6/10$  and  $\rho_3 = 4/5$  respectively. Since the queues at the three machines are  $M|M|1$  multiclass queues, the load determines the distribution. Queue 1, for instance, has a probability of  $(1 - \rho_1)\rho_1^k$  of holding  $k$  boards and the mean number of boards is

$$\sum_{k=0}^{\infty} k(1 - \rho_1)\rho_1^k = \frac{\rho_1}{(1 - \rho_1)}.$$

Hence, in steady state the mean number of customers at queues 1, 2 and 3 at a

fixed time are respectively  $\rho_1/(1 - \rho_1) = 4$ ,  $\rho_2/(1 - \rho_2) = 1.5$  and  $\rho_3/(1 - \rho_3) = 4$ . By (7.11), the steady state probability that, for instance, the first two queues are empty and the third queue contains a gadget followed by a widget on its second pass is

$$(1 - \rho_1)(1 - \rho_2)(1 - \rho_3)\rho_3^2 \frac{\lambda^d(3)}{\lambda(3)} \frac{\lambda^b(3)}{\lambda(3)} = \frac{1}{5} \frac{4}{10} \frac{1}{5} \left(\frac{4}{5}\right)^2 \frac{2}{4} \frac{1}{4}.$$

To show

$$\pi(\hat{x}) := \prod_{i=1}^J \pi_i(\bar{x}_i)$$

we again turn to Kelly's Lemma and start by guessing the transition rates of the time reversed process. Naturally we guess the time reversed network is composed of time reversed queues as in Example 7.20, which add new customers at the front of the queue and serve them from the end. The flow of customers into the queues of the time reversed network remain the same but the Markov routing is altered. Let  $\tilde{r}_i^c$  denote the proportion of boards that leave the factory from queue  $i$  of the time reversed network. The flow  $\lambda^c(i)\tilde{r}_i^c$  of class  $c$  boards from the time reversed queue  $i$ , to outside the factory, should equal the flow of class  $c$  boards from outside the factory to queue  $i$ ; that is

$$\tilde{r}_i^c = \frac{\bar{\lambda}^c(i)}{\lambda^c(i)}.$$

Similarly let  $\tilde{\lambda}^c(i)$  denote the arrival rate of class  $c$  boards to queue  $i$  from outside the network. Since the flow of class  $c$  boards into the time reversed queue  $i$  from outside the factory should equal the flow of class  $c$  boards from queue  $i$  to outside the factory, we have

$$\tilde{\lambda}^c(i) = \lambda^c(i)r_i^c.$$

Finally, let  $\tilde{r}_{ji}^{dc}$  be the proportion of class  $d$  boards at queue  $j$  which are routed as class  $c$  jobs at queue  $i$  in the time reversed network. The flow of class  $d \rightarrow c$  boards from  $j \rightarrow i$  in the time reversed network should equal the flow of class  $c \rightarrow d$  boards from  $i \rightarrow j$  in the original network so

$$\lambda^d(j)\tilde{r}_{ji}^{dc} = \lambda^c(i)r_{ij}^{cd} \text{ or } \tilde{r}_{ji}^{dc} = \frac{\lambda^c(i)r_{ij}^{cd}}{\lambda^d(j)}.$$

Note that

$$\begin{aligned} \sum_{jd} \tilde{r}_{ij}^{cd} + \tilde{r}_i^c &= \sum_{jd} \frac{\lambda^d(j)r_{ji}^{dc}}{\lambda^c(i)} + \frac{\bar{\lambda}^c(i)}{\lambda^c(i)} \\ &= \frac{\lambda^c(i) - \bar{\lambda}^c(i)}{\lambda^c(i)} + \frac{\bar{\lambda}^c(i)}{\lambda^c(i)} \\ &= 1 \end{aligned}$$

by the flow conservation equations. We conclude that  $\tilde{r}_{ij}^{cd}$  and  $\tilde{r}_i^c$  are Markov routing probabilities.

Hence, if there are  $\ell(i) = n$  boards in queue  $i$  and  $\ell(j) = m$  boards in queue  $j$  when the network is in state  $\hat{x}$ , the transition rate of the time reversed network is given by

$$\begin{aligned} q^*(A_i^c \hat{x}, \hat{x}) &= \mu_{n+1}(i) \tilde{r}_i^c = \mu_{n+1}(i) \frac{\bar{\lambda}^c(i)}{\lambda^c(i)} \\ q^*(D_i^c \hat{x}, \hat{x}) &= \tilde{\lambda}^c(i) = \lambda^c(i) r_i^c \\ q^*(T_{ij}^{cd} \hat{x}, \hat{x}) &= \mu_{m+1}(j) \tilde{r}_{ji}^{dc} = \mu_{m+1}(j) \frac{\lambda^c(i) r_{ij}^{cd}}{\lambda^d(j)}. \end{aligned}$$

We can now verify the conditions of Kelly's Lemma. First, if there are  $\ell(i) = n$  boards in queue  $i$  and  $\ell(j) = m$  boards in queue  $j$  when the network is in state  $\hat{x}$ , then

$$\begin{aligned} q^*(\hat{x}) &= \sum_{ic} \left( \tilde{\lambda}^c(i) + \mu_{\ell(i)}(i) \tilde{r}_i^c + \sum_{jd} \mu_{\ell(i)}(i) \tilde{r}_{ij}^{cd} \right) \\ &= \sum_{ic} (\lambda^c(i) r_i^c + \mu_{\ell(i)}(i)) \\ &= \sum_{ic} (\bar{\lambda}^c(i) + \mu_{\ell(i)}(i)) \\ &= q(\hat{x}) \end{aligned}$$

by equation (7.13).

Next we may consider

$$\begin{aligned} \pi(T_{ij}^{cd} \hat{x}) q^*(T_{ij}^{cd} \hat{x}, \hat{x}) &= \pi(\hat{x}) \frac{\lambda^d(j) / \mu_{m+1}(j)}{\lambda^c(i) / \mu_n(i)} \cdot \mu_{m+1}(j) \frac{\lambda^c(i) r_{ij}^{cd}}{\lambda^d(j)} \\ &= \pi(\hat{x}) \mu_n(i) r_{ij}^{cd} \\ &= \pi(\hat{x}) q(\hat{x}, T_{ij}^{cd} \hat{x}). \end{aligned}$$

The other required relations:

$$\begin{aligned} \pi(A_i^c \hat{x}) q^*(A_i^c \hat{x}, \hat{x}) &= \pi(\hat{x}) q(\hat{x}, A_i^c \hat{x}) \\ \pi(D_i^c \hat{x}) q^*(D_i^c \hat{x}, \hat{x}) &= \pi(\hat{x}) q(\hat{x}, D_i^c \hat{x}) \end{aligned}$$



are proved in a similar way. We conclude, therefore, that  $\pi$ , which is a product of the stationary distributions of the individual queues taken in isolation, is indeed the stationary distribution of the network.

The Jackson product formula may be extended beyond a network of  $M|M|1$  multiclass queues with the service rates of each queue depending on the number of customers in it. In fact, any network of quasi-reversible queues will have a product form stationary distribution! This allows extensions to various interesting special cases but one should not lose sight of the fact that these results are very fragile. Priorities are not allowed and the service rates can't depend on the class of a customer. To see this, recall from Example 7.20, that if an  $M|M|1$  multiclass queue has service rates depending on the class of the customer being served, then the state of the queue left behind at a departure depends on the class of the customer just served. If this queue is in a network then the arrival of this customer at some other node would condition the queue left behind. In other words, the queues are dependent and the product formula must be false. Priorities create similar dependencies between queues in a network.

To show exactly how fragile our theory is, let's discuss the following example.

### Example 7.22 Bramson Networks

Consider a network with two FIFO queues. Customers (or boards) arrive only at the first queue at a rate of 1 per unit time. The customers visit the queues 1, 2, 2, 2, 2, 1 and then leave the network as shown in Figure 7.6. Let these visits correspond to classes  $a, b, c, d, e, f$ . Hence  $\bar{\lambda}^a(1) = 1$  and

$$r_{12}^{ab} = 1, r_{22}^{bc} = 1, r_{22}^{cd} = 1, r_{22}^{de} = 1, r_{21}^{ef} = 1, r_1^f = 1.$$

Solving the flow conservation equations it follows that

$$\begin{aligned}\lambda^a(1) &= \bar{\lambda}^a(1) = 1 \\ \lambda^b(2) &= \lambda^a(1)r_{12}^{ab} = 1 \\ \lambda^c(2) &= \lambda^b(2)r_{22}^{bc} = 1 \\ \lambda^d(2) &= \lambda^c(2)r_{22}^{cd} = 1 \\ \lambda^e(2) &= \lambda^d(2)r_{22}^{de} = 1 \\ \lambda^f(1) &= \lambda^e(2)r_{21}^{ef} = 1.\end{aligned}$$

Let us suppose the mean service time of queue 1 is  $m(1) = 1/3$  and the service time of queue 2 is  $m(2) = 1/5$ . We may then model this network as two  $M|M|1$  multiclass queues and conclude the total flow into queue 1 is

$$\lambda^a(1) + \lambda^f(1) = 2$$

and the total flow into queue 2 is

$$\lambda^b(2) + \lambda^c(2) + \lambda^d(2) + \lambda^e(2) = 4.$$

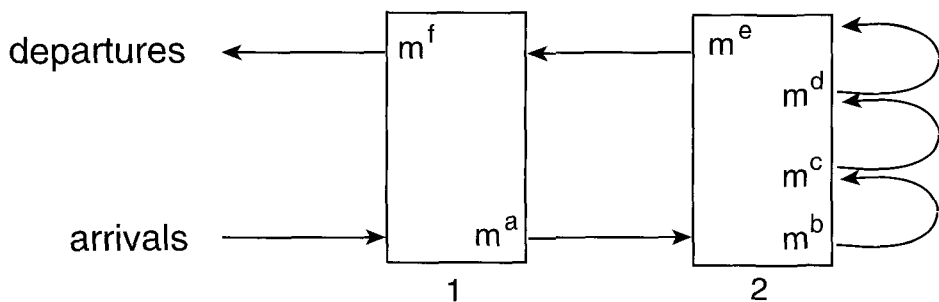

Fig. 7.6 A Bramson network.

This means the network is stable since the load on queue 1 is  $\rho(1) = 2/3 < 1$  and the load on queue 2 is  $\rho(2) = 4/5 < 1$ . The stationary distribution of a network of multiclass queues with service rates independent of the customer being served has a product form determined by the  $\rho$ 's, so we can give the entire steady state distribution.

Now let us alter the mean service times according to the class of the customer being served. Let  $m^a = 0.001$ ,  $m^b = 0.897$ ,  $m^c = 0.001$ ,  $m^d = 0.001$ ,  $m^e = 0.001$ ,  $m^f = 0.899$  denote the mean service times of the six classes. From the above arrival rates we see the load on queue 1 is

$$\rho(1) = m^a \lambda^a(1) + m^f \lambda^f(1) = 0.9$$

while the load on queue 2 is

$$\rho(2) = m^b \lambda^b(2) + m^c \lambda^c(2) + m^d \lambda^d(2) + m^e \lambda^e(2) = 0.9.$$

Since the service rates depend on the class of the customer being served, we can't expect there to be a stationary distribution which is a product as above. However, it seems reasonable that since the load on each of the queues in a network is less than 1, the network must at least be stable and there should exist some stationary distribution. Intuitively, any unstable network must have a bottleneck, i.e. a queue which can't keep up with the workload and this is not the case here.

Surprise! This network is unstable! Bramson (1994) has shown the queue sizes build up and up and tend to infinity! Imagine a slight buildup of class  $b$  customers at node 2. Since this is a slow class this buildup dribbles into classes  $c$ ,  $d$  and  $e$  but gets stuck there even though these are fast classes. This is because queue 2 is FIFO so everybody is waiting at the end of the queue for the slow class  $b$  customers. When the last class  $b$  customer clears out however there is a rush over to queue 1! Since class  $f$  at queue 1 is also slow there is a temporary bottleneck! New customers

of class  $a$  arriving from outside the network go to the end of queue 1 and can't get through to queue 2 which is starved for customers and becomes idle. Finally, the temporary bottleneck of class  $f$  customers is cleared out and the buildup of class  $a$  customers is quickly transferred to queue 2. This gives a buildup of class  $b$  customers again only now the buildup is worse than before! Going round and round like this causes bigger and bigger buildups and the queue becomes unstable. The fact that the load on each queue is less than one only means the queue can keep up with the average inflow of new work if it works all the time. Both queues here are starved during part of each cycle and so can't keep up with the load when they are working.

This example is designed to make us humble! Clearly we don't really even understand when a network has a steady state. The Jackson product formula and its extension to a network of quasi-reversible queues must be viewed as a minor miracle and the description of a real network will almost invariably be far more complex. When we also remember that the steady state tells us nothing about the network as it evolves in time, we should conclude that the study of networks will keep engineers and mathematicians busy for decades to come.

---

## 7.6 Approximation by a Markov Process

Recall our assumptions on the transition kernel  $T^\eta$ :

$$T^\eta = I + \frac{1}{\eta}G + \frac{1}{\eta^2}L_\eta, \tag{7.14}$$

where  $I$  is the identity matrix,  $G$  is a matrix such that  $\|G\| < \infty$  and  $L_\eta$  is a matrix which may depend on  $\eta$  such that  $\|L_\eta\| < \infty$  uniformly in  $\eta$ . The transition kernel  $T^\eta$  has a first order part, namely  $T^G := I + G/\eta$ . We assume  $\eta \gg \max_i G_{ii}$  so  $T^G$  is associated with a Markov chain which jumps every nanosecond. We start with an intuitive description of this discrete-time Markov chain on  $S = \{0, 1, 2, \dots\}$ . Imagine the chain is in state  $i \in S$  and imagine that every nanosecond during the sojourn in  $i$ , a Bernoulli trial is performed having probability  $p = q(i)/\eta$  of success. If a trial is a success, then the sojourn ends at the end of that nanosecond and the chain jumps to state  $j \in S$  with probability  $K_{ij}$ . If the trial is a failure, the chain does not jump away from  $i$ . It follows that the sojourn in state  $i$  is a geometric random variable having mean  $1/p = \eta/q(i)$  nanoseconds or  $1/q(i)$  seconds. Hence the sojourn is memoryless and approximately exponential! This discrete-time Markov chain has a probability transition kernel given by

$$\begin{pmatrix} 1 - q(0)/\eta & \cdots & K_{0i}q(0)/\eta & \cdots & K_{0j}q(0)/\eta & \cdots \\ \vdots & \ddots & \vdots & \ddots & \vdots & \ddots \\ K_{i0}q(i) & \cdots & 1 - q(i)/\eta & \cdots & K_{ij}q(i)/\eta & \cdots \\ \vdots & \ddots & \vdots & \ddots & \vdots & \ddots \end{pmatrix} = I + \frac{G}{\eta} = T^G.$$

We now proceed in a manner analogous to Proposition 4.20.

**Theorem 7.23** *The discrete Markov chain  $X[s]$  having kernel  $T^\eta$  can be coupled with the chain  $Y[s]$  having kernel  $T^G$ , such that*

$$P(X[s] \neq Y[s] \text{ for some } 0 \leq [s] \leq \lfloor \eta t \rfloor) \leq \frac{t}{\eta} \|L_\eta\|.$$

**Proof:** Consider any state  $i$ . The distributions after one step have probabilities  $f(j) := T_{ij}^\eta$  and  $g(j) := T_{ij}^G$ . By Proposition 4.20 there exist two random variables  $X_1(i)$  and  $Y_1(i)$  defined on the same probability space having marginal probability mass functions  $f$  and  $g$  such that  $P(X_1(i) \neq Y_1(i)) = \|f - g\|/2$ . For any  $i$

$$\begin{aligned} \|f - g\| &= \sum_j |T_{ij}^\eta - T_{ij}^G| \\ &\leq \sup_i \sum_j |T_{ij}^\eta - T_{ij}^G| \\ &= \frac{1}{\eta^2} \|L_\eta\| \text{ by (7.1).} \end{aligned}$$

By constructing a product space, we can in fact define a sequence of independent random variables  $\{X_s(i) : s = 1, 2, \dots\}$ , all with the same marginal distribution as  $X_1(i)$  and a sequence of independent random variables  $\{Y_s(i) : s = 1, 2, \dots\}$ , all with the same marginal distribution as  $Y_1(i)$ . Moreover, by taking the product of product spaces, we can define such sequences for each  $i$  all on the same probability space. We have therefore constructed a large probability space  $\{S, \mathcal{F}, P\}$  with sequences

$$\{X_s(i), Y_s(i); i \in S, s \in \{0, 1, 2, \dots\}\},$$

such that  $P(X_s(i) = j) = T_{ij}^\eta$  and  $P(Y_s(i) = j) = T_{ij}^G$  and such that

$$P(X_s(i) \neq Y_s(i)) \leq \frac{1}{\eta^2} \|L_\eta\| \text{ for all } i. \quad (7.15)$$

We now construct our Markov chains starting at  $X[0] = i_0$  and  $Y[0] = i_0$  by recursively piecing together these variables as follows: if  $X[s-1] = i$  then  $X[s] = X_s(i)$  and if  $Y[s-1] = i$  then  $Y[s] = Y_s(i)$ . These are indeed Markov chains with the required transition probabilities since for instance

$$\begin{aligned} P(X[s] = j | X[s-1] = i, X[s-2] = i_{s-2}, \dots, X[0] = i_0) \\ &= P(X_s(i) = j | X[s-1] = i, X[s-2] = i_{s-2}, \dots, X[0] = i_0) \\ &= T_{ij}^\eta. \end{aligned}$$

In the same way,  $Y[s]$  is seen to be a Markov chain with transition kernel  $T^G$ .

Now,

$$\begin{aligned}
 & P(X[s] \neq Y[s] \text{ for some } 0 \leq [s] \leq [\eta t]) \\
 &= \sum_{s=[1]}^{[\eta t]} P(X[s] \neq Y[s], X[k] = Y[k]; [1] \leq k \leq [s-1]) \\
 &= \sum_{s=[1]}^{[\eta t]} \sum_i P(X[s] \neq Y[s], \\
 &\quad X[s-1] = Y[s-1] = i, X[k] = Y[k]; [1] \leq k \leq [s-1]) \\
 &= \sum_{s=[1]}^{[\eta t]} \sum_i P(X[s] \neq Y[s] | X[s-1] = Y[s-1] = i) \\
 &\quad \times P(X[s-1] = Y[s-1] = i, X[k] = Y[k]; [1] \leq k \leq [s-1]) \\
 &= \sum_{s=[1]}^{[\eta t]} \sum_i P(X_s(i) \neq Y_s(i)) \\
 &\quad \times P(X[s-1] = Y[s-1] = i, X[k] = Y[k]; [1] \leq k \leq [s-1]) \\
 &\leq \frac{\|L_\eta\|}{\eta^2} \sum_{s=[1]}^{[\eta t]} \sum_i P(X[s-1] = Y[s-1] = i, X[k] = Y[k]; k \leq [s-1]) \\
 &\quad \text{by (7.15)} \\
 &\leq \frac{\|L_\eta\|}{\eta^2} \sum_{s=[1]}^{[\eta t]} 1 \\
 &= [\eta t] \cdot \frac{\|L_\eta\|}{\eta^2}.
 \end{aligned}$$

■

From the previous result, we see that the two chains  $X[s]$  having kernel  $T^\eta$  and  $Y[s]$  having kernel  $T^G$  are essentially indistinguishable as they evolve over time measured every nanosecond. Henceforth, we will assume our discrete time Markov chain has kernel  $T^G$  and we now turn to approximating the time evolution of  $Y[s]$  by a continuous process having probability transition semi-group  $\exp(tG)$ . By the semi-group property this continuous process observed every nanosecond will be a Markov chain with kernel  $\exp(G/\eta)$ .

We now uniformize the Markov chain  $Y[s]$ . Construct the Markov chain  $U[s]$  by performing a Bernoulli trial at each nanosecond such that, with probability  $q/\eta$ , we jump with transition probabilities  $\tilde{K}$  (see (7.5)) and with probability  $1 - q/\eta$  we stay put. First note that the kernel of this new chain is  $(1 - q/\eta)I + (q/\eta)\tilde{K} = I + G/\eta = T^G$ . In fact the two chains  $Y[s]$  and  $U[s]$  are indistinguishable. The only difference is that  $U[s]$  has fictitious jumps; that is  $K_{ii}^* > 0$  for some  $i$  so the uniformization construction puts in jumps that really aren't there. The advantage

of this description is that each Bernoulli trial is identical and does not depend on the state!

The continuous Markov process  $M(t)$  defined in Theorem 7.13 approximates  $Y[s] = U[s]$  and hence  $X[s]$ . To prove this we show this process observed on the nanoseconds and therefore denoted  $M[s]$  can be coupled to the chain  $Y[s]$ . The construction is slightly different from that of Theorem 7.23 since the process  $M(t)$  has already been constructed.

**Theorem 7.24** *The discrete Markov chain  $Y[s]$  having kernel  $T^G$  can be coupled with the chain  $M[s]$  having kernel  $\exp(G/\eta)$  such that*

$$P(Y[s] \neq M[s] \text{ for some } 0 \leq [s] \leq [\eta t]) \leq \frac{t\|G\|^2}{8\eta}.$$

**Proof:** Since we are rounding off to the nearest nanosecond, recursively define

$$N^R[s+1] = \begin{cases} N^R[s] & \text{if } N[s+1] = N[s] \\ N^R[s] + 1 & \text{if } N[s+1] \neq N[s]. \end{cases}$$

In effect  $N^R$  only counts one arrival in a given nanosecond. Now define the chain  $Y[s] := J(N^R[s])$  at each nanosecond. Clearly  $Y[s]$  has transition kernel  $(1 - q/\eta)I + (q/\eta)\tilde{K} = I + G/\eta = T^G$ . It clearly is equal to  $M[s]$  up to the moment when there are two Poisson arrivals in the same nanosecond. This has low probability as seen next.

$$\begin{aligned} & P(N^R[s] - N^R[s-1] \neq N[s] - N[s-1] \text{ for some } [1] \leq [s] \leq [\eta t]) \\ & \leq \sum_{s=[1]}^{[\eta t]} P(N[s] - N[s-1] \geq 2) \\ & = \eta t \sum_{k=2}^{\infty} \frac{1}{k!} \left(\frac{q}{\eta}\right)^k \exp(-q/\eta) \\ & = \frac{q^2 t}{\eta} \sum_{k=0}^{\infty} \frac{1}{(k+2)!} \left(\frac{q}{\eta}\right)^k \exp(-q/\eta) \\ & \leq \frac{q^2 t}{2\eta} = \frac{t\|G\|^2}{8\eta} \text{ by (7.4).} \end{aligned}$$

We conclude,

$$P(Y[s] \neq M[s] \text{ for some } 0 \leq [s] \leq [\eta t]) \leq \frac{t\|G\|^2}{8\eta}.$$

**Corollary 7.25** *The discrete Markov chain  $X[s]$  having kernel  $T^\eta$  can be coupled with the chain  $M[s]$  having kernel  $\exp(G/\eta)$  such that*

$$P(X[s] \neq M[s] \text{ for some } 0 \leq [s] \leq [\eta t]) \leq \frac{t}{\eta} \left( \|L_\eta\| + \frac{\|G\|^2}{8} \right).$$

**Proof:** The proof is immediate by combining Theorems 7.23 and 7.24. ■

**Proof of Theorem 7.5:** The proof is immediate from the preceding since by (7.1)

$$\begin{aligned}
 & |T^\eta[\eta t] - \exp(tG)| \\
 &= \sup_i \sum_j |T_{ij}^\eta[\eta t] - \exp(tG)_{ij}| \\
 &= \sup_i \sum_j |P_i(X(t) = j) - P_i(M(t) = j)| \\
 &= \sup_i \sum_j \left| \sum_{k \neq j} [P_i(X(t) = j, M(t) = k) - P_i(X(t) = k, M(t) = j)] \right| \\
 &\leq \sup_i \left[ \sum_j \sum_{k \neq j} (P_i(X(t) = j, M(t) = k) + P_i(X(t) = k, M(t) = j)) \right] \\
 &= 2 \sup_i P_i(X(t) \neq M(t)) \\
 &\leq 2 \frac{t}{\eta} \left( \|L_\eta\| + \frac{\|G\|^2}{8} \right)
 \end{aligned}$$

by Corollary 7.25 and this tends to zero as  $\eta$  tends to infinity. ■

### 7.7 Exercises

**Exercise 7.1** A Markov process is defined on two states  $\{0, 1\}$ . The process stays an exponential amount of time in each state with a mean holding time of 2, 3 seconds respectively. At the end of the holding time the process jumps according to the matrix

$$\begin{pmatrix} 1/2 & 1/2 \\ 1/4 & 3/4 \end{pmatrix}.$$

- a) Give the generator of this Markov process.
- b) Calculate the stationary distribution of this process.
- c) Calculate the mean recurrence time to state 0.
- d) Calculate the average amount of time spent in state 2.
- e) Calculate the long run probability of being in state 2 having last visited state 0.
- f) Calculate the transition kernel of the process.
- g) Write down the backward and forward equations and solve them.

**Exercise 7.2** A Markov process is defined on three states  $\{0, 1, 2\}$ . The process stays an exponential amount of time in each state with a mean holding time of 1, 5, 2 seconds respectively. At the end of the holding time the process jumps according

to the matrix

$$\begin{pmatrix} 0 & 1/2 & 1/2 \\ 2/3 & 0 & 1/3 \\ 1/4 & 3/4 & 0 \end{pmatrix}.$$

- a) Give the generator of this Markov process.
- b) Calculate the stationary distribution of this process.
- c) Calculate the mean recurrence time to state 0.
- d) Calculate the average amount of time spent in state 2.
- e) Calculate the long run probability of being in state 2 having last visited state 0.
- f) Calculate the transition kernel of the process.
- g) Write down the backward and forward equations and solve them.

Exercise 7.3 Consider the following matrix

$$P(t) = \frac{1}{7} \begin{pmatrix} 4 + 3e^{-7t} & 3 - 3e^{-7t} \\ 4 - 4e^{-7t} & 3 + 4e^{-7t} \end{pmatrix}.$$

- a) Show  $P(t)$  is a semi-group of probability transition matrices.
- b) Find the generator of this semi-group.
- c) Describe the transitions of the the associated Markov process.
- d) Find the stationary distribution of  $P(t)$ .

Exercise 7.4 Three terminals are attached to a Vax under a timesharing system. The terminals work independently. The duration of a job in nanoseconds is a geometric random variable (or approximately exponential) with a mean of ten seconds. The duration of an idle period in nanoseconds is a geometric random variable with a mean of thirty seconds. Describe the state of the system at time  $t$  to be the number of busy terminals.

- a) Give the generator of this Markov process.
- b) Give the stationary distribution of this Markov process.

Exercise 7.5 Consider a bursty source. The silence period of the source is exponentially distributed with a mean of  $s = 1.4$  seconds. The burst period is exponentially distributed with a mean of  $b = .6$  seconds. Let the silence state be represented by 0 and let the burst state be represented by 1. Let the steady state be  $(\pi(0), \pi(1))$ .

- a) Write down a system of equations for  $(\pi(0), \pi(1))$ .
- b) Calculate  $(\pi(0), \pi(1))$ .
- c) Why is it useful to calculate  $\pi(1)$ ?
- d) Suppose that during a burst period the source delivers cells at a PCR Peak Cell Rate of 1000/6 cells per second (rounded off at some point). Calculate the MBS (Mean Burst Size) and the SCR (Sustainable Cell Rate).
- e) If 5,000 VC's are established with the above statistical behavior then what is the bandwidth we must allocate if we assume all of them are peak rate.



- f) If 5,000 VC's are established with the above statistical behavior then what is the distribution of the number of burst on-going at a given time.
- g) What is the approximate probability the 5,000 VC's will require a bandwidth of more than 300,000 cells per second.

**Exercise 7.6** All the 5,000 sources described above feed an ATM multiplexor. We model these aggregated sources as one Poisson stream having the same combined SCR. We model the link of the multiplexor as an exponential server with rate 353,208 cells per second.

- What is the load on the server?
- What is the average number of cells in the multiplexor?
- What is the average number of cells in the multiplexor and what is the average delay across the multiplexor?
- If the multiplexor can only queue 20 cells, what is the CLP (Cell Loss Probability)?
- Since the sources are really bursty is this calculated CLP higher or lower than the real CLP? Why?

**Exercise 7.7** Consider a multiplexor with  $M$  input lines. We assume each line is busy or idle intermittently. The duration of a busy period is random with an exponential distribution with a mean of  $1/\mu$  seconds. The duration of an idle period is exponential with a mean of  $1/\lambda$  seconds. Assume all busy and idle periods are independent of each other. Let  $X(t)$  denote the number of busy lines at any time  $t$ .

- What is the key element in the above model that makes  $X(t)$  a Markov process?
- Give the state space and write down the backward equation for the probability transition kernel for this Markov chain.
- Give the generator  $G$  of this Markov chain as a matrix.
- Check that the vector  $\mathbf{e} := (e_0, e_1, e_2, \dots, e_N)$  defined by

$$e_n := \binom{N}{n} \left( \frac{\lambda}{\lambda + \mu} \right)^n \left( \frac{\mu}{\lambda + \mu} \right)^{N-n}$$

satisfies  $\mathbf{e}G = \mathbf{0}$ .

- What does part d) imply about the proportion of time up to some large time  $T$  that half the access lines are busy?

**Exercise 7.8** Recall Exercise 6.18. Now suppose that at most two jobs can be queued including the job being serviced. Jobs that cannot be queued are lost!

- Define the state space for a Markov process that models all the aspects of the above low and high priority queueing system.
- Write down a generator for this Markov process.
- What is the steady state probability this system is idle at a given time?

**Exercise 7.9** Consider a Markov process with states  $S = \{0, 1, 2, 3\}$ . The states  $\{0, 3\}$  are absorbing. The mean holding time before a jump in state 1 is 2 units

and the process jumps to states 0, 1, 2 and 3 with probabilities  $1/4$ ,  $1/3$ ,  $1/6$  and  $1/4$  respectively. The mean holding time before a jump in state 2 is 3 units and the process jumps to states 0, 1, 2 and 3 with probabilities  $1/4$ ,  $1/4$ ,  $1/4$  and  $1/4$  respectively.

- a) Write down the generator  $G$  of this process.
- b) Calculate the probability the process started in state 1 is eventually absorbed in state 3.
- c) Calculate the mean time until absorption starting in state 1.)
- d) Calculate the transition kernel  $P(t) = \exp(tG)$ .

**Exercise 7.10** Suppose jobs arrive at a machine shop according to a Poisson process at a rate of 3 per week. The shop finishes a job in a time that closely follows an exponential distribution with a mean of 2 days. If a job arrives when the shop is busy, the job is sent to a subcontractor who completes the job in a time that closely follows an exponential distribution with a mean of 5 days. If both shops are busy then orders are simply lost.

- a) Model this process as a Markov process and give the generator.
- b) Calculate the steady state.
- c) What proportion of the time is the subcontractor busy?

**Exercise 7.11** Imagine customers arrive in their cars at a take-out restaurant according to a Poisson process with a mean rate of 100 per hour. Suppose the order is taken immediately upon parking at one of  $N$  numbered spots. The time to fill the order is exponential with a mean of 5 minutes. When an order is filled the customer must leave the numbered spot for the next customer. Unfortunately, if a customer arrives to find all the spots occupied, the customer will give up since there is no parking nearby. Calculate (using *Mathematica*) the number of spots required to ensure the proportion of customers who have to go home dissatisfied is less than one percent.

**Exercise 7.12** An tax team is made up of a junior accountant and a senior accountant. Unprocessed income tax forms arrive at the junior accountants in-box at a rate of 10 per hour. The junior accountant processes items in the in-box in the order of arrival. He classifies incoming forms in about 3 minutes on average. About six in ten forms are complicated cases which are sent to the senior accountant. The other four in ten are simple cases that the junior accountant puts back in his own in-box. These simple cases take about 3 minutes each. The senior accountant takes about 4 minutes to handle the complicated forms.

Assuming all the processing times have an exponential distribution, calculate the probability that at the noon break the junior accountant has 3 forms for classification as well as two simple files on his desk waiting to be processed while the senior accountant has just one complicated case on his desk.

Suppose the junior accountant takes 4 minutes to handle simple cases. What can we say about the steady state of the system then?

**Exercise 7.13** There are three main attractions for children at the fair. There is the ferris wheel, a water ride and a toy train. Children arrive at the fair at the rate of 20 per hour. and with equal probability join the queue one of the three attractions. We can model the time enjoying the ferris wheel, the water ride and the toy train by exponential times with means three minutes, two minutes and four minutes respectively. After finishing the ferris wheel a child will be terrified and go home with probability  $1/2$ , join the queue at the water ride with probability  $1/5$  or join the queue at the train with probability  $3/7$ . After finishing the water ride a child will be soaked and go home with probability  $1/2$ , join the queue at the ferris wheel with probability  $1/4$  or join the queue at the train with probability  $3/4$ . After finishing the train ride a child will get bored and go home with probability  $1/2$ , join the queue at the water ride with probability  $1/3$  or join the queue at the ferris wheel with probability  $1/6$ .

- a) Calculate the probability that in steady state there are two children either queuing for or riding the ferris wheel.
- b) Calculate the probability there is nobody near the water ride at exactly 12 noon.
- c) Suppose that children arriving at the fair join the shortest queue when they arrive and then proceed as above. What can you say about the steady state?

**Exercise 7.14** Consider a network with two nodes. Customers arrive from outside the network at node 1 according to a Poisson process at a rate of 1 every two minutes. Customers arrive from outside the network at node 2 according to a Poisson process at a rate of 3 every two minutes. The service time at node 1 is exponential with mean 1 minute and after service, customers leave the network with probability .5 or join the queue at node 2 with probability 0.5. The service time at node 2 is exponential with mean 30 seconds and after service, customers leave the network with probability .75 or join the queue at node 1 with probability 0.25.

- a) Calculate the probability the queue at node 2 exceeds 5 customers when the system is in its steady state.
- b) What is the probability that an arrival from outside the network to node 1 does not have to wait before being served?
- c) If the network is in its steady state what is the probability there are 2 customers at node 2 given there are two customers in the queue at node 1?
- c) Describe the departure process from node 2.
- d) Calculate the time reversal of this chain and comment on your results.

**Exercise 7.15** Consider a closed Jackson network with  $m$  nodes and  $\bar{\lambda}_i = 0$  and  $r_i = 0$  for all nodes. This means that if  $n$  customers are present, these customers stay forever, bouncing around from node to node! We wish to show that there is a steady state for this closed system!

- a) Consider any Markov process (or chain) with stationary distribution  $\pi$  and states  $E$  such that

$$q(i, j) = 0 \text{ if } (i, j) \in E \times E^C \cup E^C \times E.$$

Show

$$\pi_E(i) = \frac{\pi(i)\chi\{i \in E\}}{\pi(E)} \text{ is invariant.}$$

b) Return to the closed Jackson network. We can write down the light traffic equations  $\lambda_j = \sum_i \lambda_i r_{i,j}$  or  $\lambda^T(I - r) = 0$ . Show this system has at least one non-zero solution.

c) Define the Jackson product

$$\pi(\vec{x}) = \prod_{i=1}^m \left(1 - \frac{\lambda_i}{\mu_i}\right) \left(\frac{\lambda_i}{\mu_i}\right)^{x_i}$$

and show that it is a stationary distribution. (Perturb the closed Jackson network with a fake outside input  $\bar{\lambda}_i$  and a fake  $r_{j..}$ . Solve the perturbed system and then let the perturbation tend to 0. Alternatively use brute force and calculate

$$\sum_{\chi} \pi(\vec{x})q(\vec{x}, \vec{y}) = \pi(\vec{y})q(\vec{y}) \text{ for all states } \vec{y}.)$$

d) Use a), taking  $E = \{\vec{x} : \sum x_i = u\}$  to calculate the stationary distribution of the closed network.

## Chapter 8

# Markov Decision Theory

### 8.1 Introduction

We consider a Markov chain whose transition probabilities are decided at each transition according to the actions of a controller. Each action has an associated cost and the goal of the controller is to minimize the expected cost up to a finite horizon  $N$ . Let  $\mathcal{S}$  be a countable state space of the Markov chain. If the chain is in state  $i$  at time  $t$  and the controller picks an action  $a_t$  from a *finite* action set  $\mathcal{A}(t, i)$  associated with state  $i$  then two things occur:

- The transition probabilities from state  $i$  to state  $j$  are then given by  $K_{ij}(t, a_t)$ .
- A cost  $C(t, i, a_t)$  is incurred.

Let  $X_t$  represent the state at time  $t$  and let  $A_t$  represent the action taken at time  $t$ . Define the past or history up to time  $t$  by

$$\left(\vec{X}_t, \vec{A}_t\right) = ((X_0, X_1, \dots, X_t), (A_0, A_1, \dots, A_t)).$$

The preceding assumptions imply

$$P\left(X_{t+1} = j \mid \vec{X}_t = \vec{x}_t, \vec{A}_t = \vec{a}_t\right) = K_{ij}(t, a_t)$$

where  $\vec{x}_t = (x_0, x_1, \dots, x_t)$ ,  $x_t = i$  and  $\vec{a}_t = (a_0, a_1, \dots, a_t)$  are the sequence of states and actions taken until time  $t$ . This Markovian structure leads to a considerable simplification of the decision making process as we shall see.

The controller who is not clairvoyant must operate according to some *policy*  $\phi \in \Phi$  which at each time  $t$  assigns an action  $A_t$  depending on the past up to  $t$  and the time to the horizon; that is

$$A_t = \phi^{t,N}\left(\left(\vec{X}_{t-1}, \vec{A}_{t-1}\right), X_t\right).$$

This policy may, in principal, even depend on an additional randomization – when in doubt flip a coin! In this case, given  $X_t$  and  $A_{t-1}$ ,  $\phi$  is a random variable with a p.m.f. which gives the probability of choosing one action in  $A_t$ . Once the policy

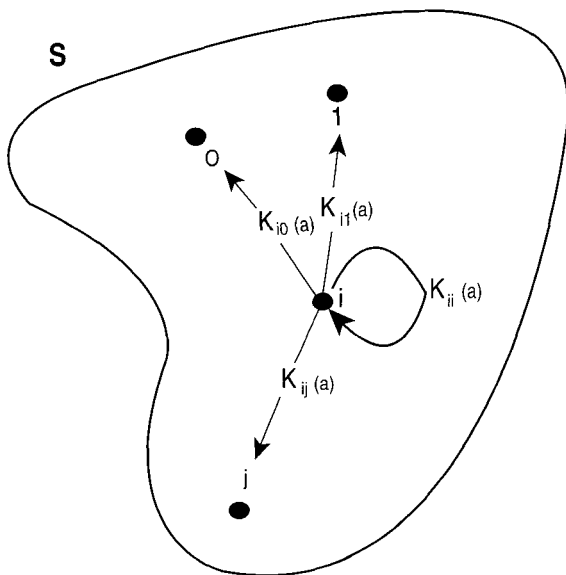

Fig. 8.1 A controlled Markov chain

$\phi$  has been chosen the transition probabilities are determined and we can construct the probability measure  $P_\phi$  and the expectation  $E_\phi$  associated with this policy.

The set  $\mathcal{M}$  of Markovian policies is of particular interest. A policy  $\mu \in \mathcal{M}$  if

$$A_t = \mu^{t,N} \left( \left( \vec{X}_{t-1}, \vec{A}_{t-1} \right), X_t \right) = \mu^{t,N}(X_t).$$

Such a policy only depends on the time  $t$ , the current state and the time remaining to the horizon.

The total cost associated with a policy  $\phi$  is

$$\sum_{t=0}^N C(t, X_t, A_t),$$

where  $C(t, X_t, A_t)$  is the cost of the  $t^{\text{th}}$  decision. To compare various policies we compare expected values although the variance of the total cost associated with a policy is also an issue. The goal then of this chapter is to find a strategy to minimize the expected total cost.

In Section 8.2 we shall establish the existence of an optimal Markovian policy that minimizes the expected total cost along with an algorithm based on backwards

induction for computing the policy and the associated costs. This policy will be shown to be optimal even among policies in  $\Phi$ . In Section 8.3 we shall consider the infinite horizon case and show when an explicit solution to this problem may approximate the solution of the finite horizon problem. In section 8.5 we study another tractable infinite horizon problem, that of optimal stopping. Finally, in Section 8.6 we establish the optimality of the Cusum quality control procedure defined in Example 5.36.

**Example 8.1 Optimal parking**

Consider the problem of parking your car in a long underground parking garage, as in Figure 8.2. There are  $N + 1$  parking spots one after the other and you want to park as close as possible to the elevator opposite the last parking space. You start opposite the first spot, labelled spot 0. If this spot is empty you must decide to park or not. Unfortunately in the darkness you can't see beyond your present location so you can't see if spots closer to the elevator are free or not. If you don't park you have to advance your car to the next spot and decide again and since there are other cars after you, you can't back up.

If you drive down the entire aisle without parking you will give up in frustration which represents a cost of  $F$  dollars. If you park in spot  $n$ , you have to walk to the elevator at a cost of  $d[n]$  dollars, where  $d[n]$  decreases with  $n$  (the closer the better). We assume spot  $n$  is empty with probability  $p[n]$  and we assume the spots are empty or full independently of each other. The question is, what is the optimal parking strategy to minimize the expected cost?

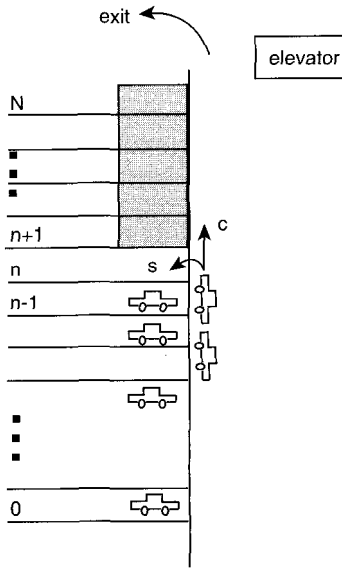

Fig. 8.2 Optimal parking

To model this problem we define a state space as follows: let  $e$  represent the state where you are opposite an empty spot. Let  $f$  represent the state where you are opposite a full spot. In this example we can identify time with the corresponding number of the parking spot; consequently, the horizon is  $N$ . For completeness, we shall introduce a terminal state  $\Delta$  which indicates you have parked or gone home in frustration. The cost associated with state  $\Delta$  is defined to be 0 and we treat this state as absorbing. At time  $t < N$  you have two actions associated with state  $e$ :  $s$  for stop and park or  $c$  for continue. Hence  $\mathcal{A}(t, e) = \{s, c\}$ . The transition kernels and costs corresponding to action  $s$  are  $K_{e,\Delta}(t, s) = 1$  and  $C(t, e, s) = d[t]$ . The transition kernels and costs corresponding to action  $c$  are

$$K_{e,e}(t, c) = p[t + 1], K_{e,f}(t, c) = 1 - p[t + 1] \text{ for } t \leq N - 1, \\ K_{e,\Delta}(N, c) = 1$$

and  $C(t, e, c) = 0$  for  $t < N$  while  $C(N, e, c) = F$ . Associated with state  $f$  you have only action  $c$ . The corresponding transition kernel is

$$K_{f,e}(t, c) = p[t + 1], K_{f,f}(t, c) = 1 - p[t + 1] \text{ for } t \leq N - 1 \\ K_{f,\Delta}(N, c) = 1$$

and the cost is  $C(t, f, c) = 0$  for  $t < N$  while  $C(N, f, c) = F$ .

It may be that the cost incurred in taking an action  $a$  at time  $t$  while in state  $i$ , may depend upon extra random variables like the next state entered or an independent coin flip. Hence the cost would be  $C(t, i, Y, a)$  where  $Y$  is a random variable whose distribution is determined by  $(t, i, a)$ . Since we will be comparing policies like  $\phi$  by their expected cost, this means we must calculate

$$E_\phi \sum_{t=0}^N C(t, X_t, Y_t, A_t).$$

Now conditioning on  $X_t$  and  $A_t$  we see this cost is equal to

$$E_\phi \sum_{t=0}^N E(C(t, X_t, Y_t, A_t) | X_t, A_t).$$

For instance, if the cost depends on the next state entered then  $C(t, i, Y, a) = C(t, i, j, a)$ , if the next state entered is  $j$ . Hence

$$E(C(t, X_t, Y_t, A_t) | X_t, A_t) = \sum_j K_{X_t, j}(t, A_t) C(t, X_t, j, A_t).$$

In other words, we have reduced to the case where  $C$  does not depend on the extra variable  $Y$  by replacing  $C(t, i, Y, a)$  by

$$C(t, i, a) := E(C(t, i, Y, a) | X_t = i, A_t = a)$$



since the two problems have the same expected costs.

### Example 8.2 Buffer control

A server is driven by an input process of queries. In each time slot or time interval there is probability  $p$  of a query arrival and the server completes service on the head of the line query with probability  $q$ . We assume  $p < q$ . Some servers will queue all incoming queries until the buffer space is exhausted. If there is no buffer space available then the incoming query is destroyed or dropped. Some routers perform active queue management. When a query arrives a decision is made whether or not to drop the query long before the buffer overloads.

Part of the advantage of active queue management is the reduction in query delay. If the duration of a time slot is  $C$  microseconds then we incur a delay of  $C$  microseconds for each time slot a query is kept waiting. Let the number of queries waiting or being served at time  $t$  be  $Q[t]$  so keeping  $Q[t]$  queries waiting will cost  $C \cdot Q[t]$  during the time slot  $t$ . If a query is dropped at the server the source will eventually retransmit the query. This query will therefore suffer a large one time delay of  $M$  microseconds. We wish to determine the optimal policy for minimizing the expected total delay over the next  $N$  time slots.

Since the arrival process has geometric interarrival times and since the service times are geometric, the entire past of the process is summarized by the state  $x$ , which represents having  $Q[t] = x$  queries in the queue. At each time unit we have an action space  $\mathcal{A} = \{0, 1\}$  which denotes the actions of respectively accepting or rejecting an arriving query. Let  $q(x) = q$  if  $x > 0$  and 0 if  $x = 0$ . Given the action chosen is 0, the transition  $x \rightarrow x + 1$  occurs during one time unit when there is an arrival without any service completions. Hence,

$$\begin{aligned} K_{x,x+1}(t, 0) &= p(1 - q(x)) \text{ and similarly,} \\ K_{x,x-1}(t, 0) &= (1 - p)q(x), \\ K_{x,x}(t, 0) &= (1 - p)(1 - q(x)) + pq(x). \end{aligned}$$

The transitions for action 1 are analogous.

The cost, if action 0 is taken, is  $Cx$  if  $x$  queries are in the buffer; i.e.  $C(t, x, 0) = Cx$ . If action 1 is taken then there is a cost of  $Cx$  plus the cost  $M$  if a query is dropped. Let  $Y_t$  denote the event that a query arrives at time  $t$ ; that is  $Y_t = 1$  if a query arrives at time  $t$  and 0 otherwise. Hence,  $C(t, x, Y_t, 1) = Cx + M \cdot Y_t$ . Consequently we study the expected cost

$$C(t, x, 1) := E(C(t, x, Y_t, 1) | Q[t] = x, A_t = 1) = Cx + pM.$$

---

## 8.2 The Optimality Equation

In principle the expected value of the total cost of a policy  $\phi$

$$E_\phi \left( \sum_{t=0}^N C(t, X_t, A_t) | X_0 = i \right).$$

may not even exist! However, since we have only a finite capital to risk we shall assume it only feasible to use policies in  $\Gamma \subseteq \Phi$  such that

$$E_\phi \left( \sum_{t=0}^N C(t, X_t, A_t)^+ | X_0 = i \right) < \infty.$$

We assume throughout that there exists at least one Markovian policy  $\bar{\phi} \in \Gamma$ . If in fact  $C(t, i, a)$  is uniformly bounded or if the range of the Markov chain over  $N$  periods is finite then all policies would be in  $\Gamma$ .

### Example 8.3 Pathological Cases

Consider a Markov chain on the integers  $S = \{\dots, -1, 0, 1, \dots\}$  with two actions  $c$  and  $s$  at time  $t = 0$  and only action  $s$  at time  $t = 1$ . Suppose  $N = 1$ . Suppose that  $K_{0,n}(0, c) = (10^6 n(n+1))^{-1}$  for  $n = 1, 2, \dots$ ,  $K_{0,0}(0, c) = 1 - 10^{-6}$  and  $K_{0,0}(0, s) = 1$ . Suppose  $C(0, 0, s) = 0$ ,  $C(0, 0, c) = -10^8$ ,  $C(1, n, s) = n$  for  $n = 0, 1, 2, \dots$ . Note that

$$\sum_{n=1}^{\infty} \frac{1}{n(n+1)} = \sum_{n=1}^{\infty} \left( \frac{1}{n} - \frac{1}{n+1} \right) = 1$$

so  $K$  is a transition kernel. If we decide on action  $c$  at time  $t = 0$  it is almost certain that we will gain one hundred million. Nevertheless this strategy is not permitted (it is not in  $\Gamma$ ) because  $C(0, 0, c)^+ + EC(1, X_1, s)^+ = +\infty$ . We just can't play the game and we get nothing. Of course nobody would offer to play this game with us because it's pretty clear we would default if by bad luck we had to pay a large cost.

---

For simplicity we first consider Markovian policies. The expected cost from time  $n$  to the horizon associated with a finite horizon Markovian policy  $\mu \in \mathcal{M} \subset \Gamma$  given the chain starts in state  $i$  is

$$W_\mu^{n,N}(i) = E_\mu \left[ \sum_{t=n}^N C(t, X_t, A_t) | X_n = i \right].$$

The optimal cost associated with policies in  $\mathcal{M}$  is

$$W^{n,N}(i) = \inf_{\mu \in \mathcal{M}} W_\mu^{n,N}(i).$$

By our hypothesis  $W^{n,N}(i)$  exists but it is not clear at this point that there is indeed a Markovian policy which yields these expected costs or if the expected cost

is minus infinity. If the state space is finite or if the range of the Markov chain over  $N$  periods is finite then the minimum cost would be finite.

The following functional equation for the optimal cost associated with Markovian policies is often called the Bellman optimality equation.

**Theorem 8.4**

$$\begin{aligned}
 W^{n,N}(i) &= \min_{a \in \mathcal{A}(n,i)} \left\{ C(n, i, a) + \sum_{j \in \mathcal{S}} K_{ij}(n, a) W^{n+1,N}(j) \right\} \\
 W^{N,N}(i) &= \min_{a \in \mathcal{A}(N,i)} \{ C(N, i, a) \}
 \end{aligned}
 \tag{8.1}$$

We defer the proof until we have made some use of the theorem.

**Corollary 8.5** *The Markovian policy  $\rho$  defined by*

$$\rho^{n,N}(i) = \rho^{n,N} \left( \left( \vec{X}_{n-1}, \vec{A}_{n-1} \right), X_n = i \right) = a^*$$

where  $a^*$  is the choice of  $a$  that minimizes

$$C(n, i, a) + \sum_{j \in \mathcal{S}} K_{ij}(n, a) W^{n+1,N}(j)
 \tag{8.2}$$

is an optimal Markovian policy and  $W_\rho^{n,N}(i) = W^{n,N}(i)$  for all  $n$ .

**Proof:** We proceed by induction. Clearly, by definition,  $\rho^{N,N}$  minimizes  $C(N, i, a)$ . It follows that  $W_\rho^{N,N}(i) = W^{N,N}(i)$ . Next suppose that the corollary holds for all  $\{m + 1, \dots, N\}$ . Then evaluating as in (8.3) we have

$$\begin{aligned}
 W_\rho^{m,N}(i) &= C(m, i, a^*) + \sum_{j \in \mathcal{S}} K_{ij}(m, a^*) W_\rho^{m+1,N}(j) \\
 &= C(m, i, a^*) + \sum_{j \in \mathcal{S}} K_{ij}(m, a^*) W^{m+1,N}(j) \text{ by hypothesis} \\
 &= \min_{a \in \mathcal{A}(m,i)} \left\{ C(m, i, a) + \sum_{j \in \mathcal{S}} K_{ij}(m, a) W^{m+1,N}(j) \right\} \text{ by definition} \\
 &= W^{m,N}(i) \text{ by Theorem 8.4.}
 \end{aligned}$$

The result now follows by induction on  $m$ . ■

We should remark that the above optimal Markovian policy is not always unique. In the parking example, suppose there is a cost of one dollar to park anywhere and the cost of going home in frustration  $F$  is also one dollar. In this case it doesn't matter what strategy we take and  $W^{n,N}(e) = W^{n,N}(f) = 1$ . Even worse there is no guarantee that  $\rho \in \Gamma$ .

**Example 8.6 Pathological Cases - (8.3) continued** Consider a Markov chain on the integers  $S = \{\dots, -1, 0, 1, \dots\}$  with one action  $c$  at time  $t = 0$ , actions  $s$  and  $c$  at time 1 and action  $s$  at time 2.  $N = 2$ . Suppose that  $K_{0,n}(0, c) = (n(n + 1))^{-1}$

for  $n = 1, 2, \dots$ . For all  $n$ ,  $K_{n,n}(1, c) = K_{n,-2n}(1, c) = 1/2$  and  $K_{n,n}(2, s) = 1$ . Further, for all  $n$ ,  $C(0, 0, c) = 0$ ,  $C(1, n, c) = C(1, n, s) = 0$  and  $C(2, n, s) = n$ .

A Markovian policy  $\mu_N$  in  $\Gamma$  might be to take action  $c$  at time  $t = 1$  if  $X_1 \leq N$  and action  $s$  otherwise. The expected cost of  $\mu_N$  is

$$W_{\mu_N}^{0,2}(0) = -\frac{1}{2} \sum_{n=1}^N n(n(n+1))^{-1}.$$

Clearly  $W^{0,2}(0) = -\infty$  and the optimal policy  $\rho$  always takes action  $c$  at time  $t = 1$ .  $\rho$  is the policy obtained by backward induction but  $\rho$  is not in  $\Gamma$ .

This theorem and its corollary provides a practical method of determining the minimum possible cost  $W^{0,N}(i)$  at least when the set of points accessible from  $i$  in  $N$  steps is finite; i.e. if the set  $R_i^N$  defined below is finite:

$$R_i^n = \{j : K_{i,i_1}(0, a_0) \cdot K_{i_1,i_2}(1, a_1) \cdots K_{i_{n-1},j}(n-1, a_{n-1}) > 0\}$$

for some  $(a_0, a_1, \dots, a_{n-1})$  and  $(i, i_1, \dots, i_{n-1}, j)$ .

The optimal policy at the horizon  $N$  is the myopic strategy to minimize the cost on the last step. Calculate the value of the myopic strategy on  $R_i^N$ . Next, use Bellman's optimality equation to work backward to calculate the minimum cost on  $R_i^{N-1}$  and so on down from the horizon until, after  $N$  iterations, we can determine  $W^{0,N}(i)$  on  $R_i^0 = \{i\}$ . This is called backward induction.

**Example 8.7 Buffer control - (8.2) continued**

At any time  $n$  there are only two actions - drop or accept an incoming query. Note that the policy  $\bar{\phi}$  of always rejecting queries has bounded costs so  $\Gamma$  is not empty. We can therefore talk about expected costs. If  $W^{n,N}(x)$  denotes the minimum expected cost starting at time  $n$ , with  $x$  queries in the queue, then the Bellman optimality equation says

$$W^{n,N}(x) = \min\{Cx + T_0[W^{n+1,N}](x), Cx + pM + T_1[W^{n+1,N}](x)\},$$

where the operators  $T_0$  and  $T_1$  associated with accepting or rejecting queries respectively operate on any function  $u$  by

$$\begin{aligned} T_0[u](x) &= p(1 - q(x))u(x + 1) + (1 - p)(1 - q(x))u(x) \\ &\quad + pq(x)u(x) + (1 - p)q(x)u(x - 1) \\ T_1[u](x) &= p(1 - q(x))u(x) + (1 - p)(1 - q(x))u(x) \\ &\quad + pq(x)u(x - 1) + (1 - p)q(x)u(x - 1). \end{aligned}$$

At time  $N$  it is clearly best to use action 0 since don't drop a query and we don't have to worry about future costs due to long queues; that is  $W^{N,N}(x) = Cx$ .

Since the cost structure and the transition probabilities are time invariant it follows that  $W^{n,N}(x) = W^{0,N-n}(x)$ . Consequently, if we define  $W^N(x) = W^{0,N}(x)$

to be the minimum cost over the next  $N$  transitions, then we can rewrite the Bellman optimality equation as

$$W^N(x) = \min\{Cx + T_0[W^{N-1}](x), Cx + pM + T_1[W^{N-1}](x)\}.$$

Suppose we wish to start with an empty queue so we want to calculate  $W^N(0)$ . To do backward induction from the horizon at time  $N$  back to time 0, we must start with calculating (and saving in computer memory)  $W^0(x) = Cx$  for all  $x \in R_0^N = \{x : 0 \leq x \leq N\}$  since only these states can be reached from 0 in time  $N$ . Similarly, working backward we only need calculate  $W^n(x)$  for all  $0 \leq x \leq N - n$ . Proceeding in this way, the last step of the backward induction gives precisely what we want; that is  $W^N(0)$ . Since we are doing these calculations iteratively we only need store the results for  $W^n$  in order to calculate  $W^{n+1}$  so these computations are feasible. The optimal policy  $\rho$  given by backward induction is necessarily in  $\Gamma$  since the queue size and hence the costs remain bounded over  $N$  transitions. We do note that if we want to calculate  $W^{N+1}(0)$  we almost have to start all over again.

---

**Example 8.8 Optimal parking - (8.1) continued**

First note that the total cost is bounded so all strategies are in  $\Gamma$ . If we define  $W^{n,N}(e)$  to be the optimal cost starting from state  $e$  opposite spot  $n$ , the Bellman optimality equation becomes

$$W^{n,N}(e) = \min\{d[n], p[n + 1]W^{n+1,N}(e) + (1 - p[n + 1])W^{n+1,N}(f)\}$$

for  $n \leq N - 1$ . Moreover,

$$W^{N,N}(e) = \min\{d[N], F\}.$$

Define  $W^{n,N}(f)$  to be optimal cost starting from state  $f$ , opposite spot  $n$ . For  $n \leq N - 1$  the Bellman optimality equation becomes

$$W^{n,N}(f) = p[n + 1]W^{n+1,N}(e) + (1 - p[n + 1])W^{n+1,N}(f).$$

Moreover,

$$W^{N,N}(f) = F.$$

For completeness, define  $W^{n,N}(\Delta) = 0$  for all  $n$ .

In any reasonable situation,  $d[n]$ , the cost of walking to the elevator from spot  $n$  decreases as  $n$  increases to  $N$  since everyone would like to park near the elevator. Finally,  $F > d[N]$  since otherwise it would always be best to go home without parking. If these natural conditions hold, we argue below that  $W^{n,N}(f)$  is increasing in  $n$  and  $W^{n,N}(e)$  is decreasing.

First we remark that from the Bellman optimality equation  $W^{n,N}(f) \geq W^{n,N}(e)$ . Now we use induction to show the required monotonicity. Suppose for

$n \geq m + 1$  we have  $W^{n,N}(f)$  is increasing in  $n$  and  $W^{n,N}(e)$  is decreasing. Clearly,

$$\begin{aligned} W^{m,N}(f) &= p[m+1]W^{m+1,N}(e) + (1-p[m+1])W^{m+1,N}(f) \\ &\leq p[m+1]W^{m+1,N}(f) + (1-p[m+1])W^{m+1,N}(f) = W^{m+1,N}(f) \end{aligned}$$

and

$$\begin{aligned} W^{m,N}(e) &= \min\{d[m], p[m+1]W^{m+1,N}(e) + (1-p[m+1])W^{m+1,N}(f)\} \\ &\geq \min\{d[m], p[m+1]W^{m+1,N}(e) + (1-p[m+1])W^{m+1,N}(e)\} \\ &= \min\{d[m], W^{m+1,N}(e)\} \geq \min\{d[m+1], W^{m+1,N}(e)\} \\ &= W^{m+1,N}(e) \end{aligned}$$

since  $d[m] \geq d[m+1]$  by hypothesis and  $d[m+1] \geq W^{m+1,N}(e)$  by Bellman's equation. The monotonicity is automatically true if  $m = N$  so by the induction principle it is true for all  $n$ .

We therefore conclude that  $W^{n,N}(f) \geq W^{n,N}(e)$  for all  $n$  and since  $W^{n,N}(f)$  is increasing and  $W^{n,N}(e)$  is decreasing that we may have equality up to some  $n_0$  but for  $n > n_0$   $W^{n,N}(f) > W^{n,N}(e)$ . By Corollary 8.5 below this means it is optimal to continue for  $n \leq n_0$  but for  $n > n_0$  it is optimal to stop as soon as possible.

---

**Proof of Theorem 8.4:** The proof of (8.1) is immediate: with only one decision to make, a nearsighted policy is optimal. Let  $\mu$  be a Markovian policy in  $\Gamma$ . If  $\mu$  chooses action  $a$  at time  $n$  while in state  $i$ .

$$\begin{aligned} W_{\mu}^{n,N}(i) &= C(n, i, a) + E_{\mu} \left[ \sum_{t=n+1}^N C(t, X_t, A_t) | X_n = i \right] \\ &= C(n, i, a) \\ &\quad + \sum_{j \in \mathcal{S}} K_{ij}(n, a) E_{\mu} \left[ \sum_{t=n+1}^N C(t, X_t, A_t) | X_n = i, A_n = a, X_{n+1} = j \right] \\ &= C(n, i, a) + \sum_{j \in \mathcal{S}} K_{ij}(n, a) W_{\mu}^{n+1,N}(j) \end{aligned} \tag{8.3}$$

where we have used the Markovian nature of  $\mu$  and the transition mechanism. Hence,

$$\begin{aligned} W_{\mu}^{n,N}(i) &\geq C(n, i, a) + \sum_{j \in \mathcal{S}} K_{ij}(n, a) W^{n+1,N}(j) \\ &\geq \min_{a \in \mathcal{A}(n, i)} \{C(n, i, a) + \sum_{j \in \mathcal{S}} K_{ij}(n, a) W^{n+1,N}(j)\}. \end{aligned} \tag{8.4}$$

Since

$$W^{n,N}(i) = \inf_{\mu \in \mathcal{M}} W_{\mu}^{n,N}(i)$$

we have, by taking the infimum of both sides of (8.4), that

$$W^{n,N}(i) \geq \min_{a \in \mathcal{A}(n,i)} \{C(n,i,a) + \sum_{j \in \mathcal{S}} K_{ij}(n,a)W^{n+1,N}(j)\}.$$

To prove the reverse inequality let  $a^*$  be the action such that

$$C(n,i,a^*) + \sum_{j \in \mathcal{S}} K_{ij}(n,a^*)W^{n+1,N}(j) = \min_{a \in \mathcal{A}(n,i)} \{C(n,i,a) + \sum_{j \in \mathcal{S}} K_{ij}(n,a)W^{n+1,N}(j)\}.$$

Now define a policy  $\mu$ , starting with action  $a^*$  in state  $i$  at time  $n$ , such that if the next state is  $j$  the policy  $\mu_j^*$  is followed from then on.

If  $W^{n+1,N}(j) > -\infty$  for all  $j$  then the policy  $\mu_j^*$  may be chosen such that for all  $j$  and  $\epsilon$  arbitrarily small

$$W_{\mu_j^*}^{n+1,N}(j) \leq W^{n+1,N}(j) + \epsilon.$$

Hence, by (8.4)

$$\begin{aligned} W_{\mu}^{n,N}(i) &= C(n,i,a^*) + \sum_{j \in \mathcal{S}} K_{ij}(n,a^*)W_{\mu_j^*}^{n+1,N}(j) \\ &\leq C(n,i,a^*) + \sum_{j \in \mathcal{S}} K_{ij}(n,a^*)W^{n+1,N}(j) + \epsilon. \end{aligned}$$

Hence, by the definition of the infimum, we have

$$W^{n,N}(i) \leq C(n,i,a^*) + \sum_{j \in \mathcal{S}} K_{ij}(n,a^*)W^{n+1,N}(j) + \epsilon.$$

Now since  $\epsilon$  is arbitrary the reverse inequality follows.

Even if  $W^{n+1,N}(j) = -\infty$  for  $j$  in some set  $I_{n+1}$  then for those  $j \in I_{n+1}$  pick the policy  $\mu_j^*$  such that

$$W_{\mu_j^*}^{n+1,N}(j) \leq -L \text{ where } L \text{ is arbitrarily large.}$$

Hence, by the definition of  $a^*$ ,

$$\begin{aligned} W_{\mu}^{n,N}(i) &= C(n,i,a^*) + \sum_{j \in \mathcal{S}} K_{ij}(n,a^*)W_{\mu_j^*}^{n+1,N}(j) \\ &\leq C(n,i,a^*) + \sum_{k \notin I_{n+1}} K_{ik}(n,a^*)W_{\mu_j^*}^{n+1,N}(j) + \sum_{k \in I_{n+1}} K_{ik}(n,a^*)(-L). \end{aligned}$$

Hence,

$$W^{n,N}(i) \leq C(n,i,a^*) + \sum_{k \notin I_{n+1}} K_{ik}(n,a^*)W_{\mu_j^*}^{n+1,N}(j) + \sum_{k \in I_{n+1}} K_{ik}(n,a^*)(-L).$$

Since  $L$  is arbitrarily large,  $W^{n,N}(i) = -\infty$  so the reverse inequality follows. ■

**Example 8.9 Optimal parking - (8.8) continued**

Consider a special case where  $N = 50$ ,  $p[n] = 1 - n/(N + 1)$ ,  $d[n] = N - n$  and  $F = 50$ . Clearly we should not park in spot 0 even if it is empty since we would pay a cost of 50 which is just as bad as giving up and going home. The following graphs of  $W^{n,N}(f)$  and  $W^{n,N}(e)$  are equal for  $n \leq n_0 = 35$ , but after that  $W^{n,N}(e)$  decreases to 0 while  $W^{n,N}(f)$  increases. This is just what we would expect! By the Bellman optimality equation we know that if it is optimal not to park in spot  $n$  then

$$W^{n,N}(e) = p[n + 1]W^{n+1,N}(e) + (1 - p[n + 1])W^{n+1,N}(f) = W^{n,N}(f).$$

On the other hand, if it is optimal to park at  $n$ , then  $W^{n,N}(e) = d[n] < W^{n,N}(f)$ . Using the following program in *Mathematica* we may easily solve for  $W^{n,N}(e)$  denoted by  $WE[n]$  and  $W^{n,N}(f)$  denoted by  $WF[n]$ .

```
Num:=50 F:=50 d[n_]:=Num-n
p[n_]:=1-(n/(Num+1)) WF[Num]:=F WE[Num]:=d[Num]
WE[n_]:=WE[n]=Min[p[n+1] WE[n+1]+(1-p[n+1]) WF[n+1],d[n]]
WF[n_]:=WF[n]=p[n+1] WE[n+1]+(1-p[n+1]) WF[n+1]
twe=Table[WE[n],{n,Num}] twf=Table[WF[n],{n,Num}]
```

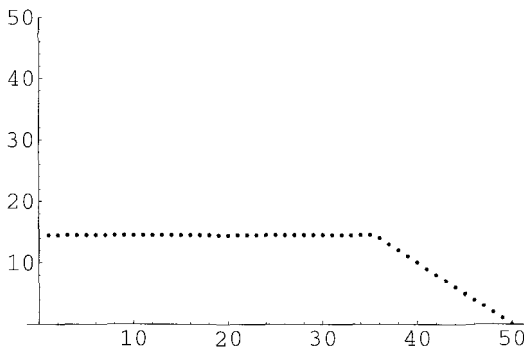

Fig. 8.3 ListPlot[twe] gives the expected cost if  $n$  is empty.

The optimal policy is to park in the first empty spot after spot 35 as can be seen from Figures 8.3 and 8.4. For  $n \leq 35$  we never park so the expected cost  $W^{n,N}(f) = W^{n,N}(e) = 14.4745$ .

We now establish the intuitively obvious: the Markovian policies are optimal among all policies  $\phi \in \Gamma$ . The past up to time  $n$  is given by  $((\vec{x}_{n-1}, \vec{a}_{n-1}), x_n = i)$  where  $\vec{x}_{n-1} = (x_0, x_1, \dots, x_{n-1})$  are the states entered and  $\vec{a}_{n-1} = (a_0, a_1, \dots, a_{n-1})$  are the actions taken from time 0 to time  $n - 1$ . The



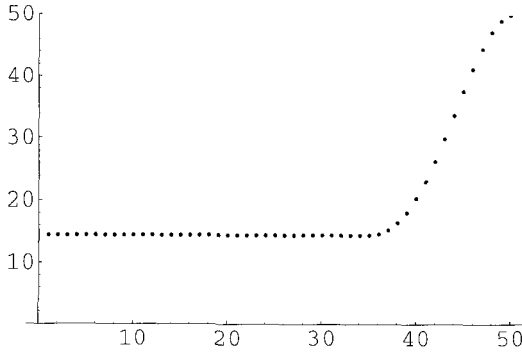

Fig. 8.4 ListPlot[twfl] gives the expected cost if  $n$  is full.

expected cost from time  $n$  to the horizon associated with a finite horizon policy  $\phi$ , given the past up to  $n$ ,  $((\vec{x}_{n-1}, \vec{a}_{n-1}), x_n = i)$ , is denoted by:

$$\begin{aligned}
 &V_\phi^{n,N}((\vec{x}_{n-1}, \vec{a}_{n-1}), i) \\
 &= E_\phi \left[ \sum_{t=n}^N C(t, X_t, A_t) \mid \left( \vec{X}_{n-1} = \vec{x}_{n-1}, \vec{A}_{n-1} = \vec{a}_{n-1} \right), X_n = i \right].
 \end{aligned}$$

The optimal cost from time  $n$  to the horizon, given the past up to  $n$ , among policies in  $\Gamma$  is

$$V^{n,N}((\vec{x}_{n-1}, \vec{a}_{n-1}), i) = \inf_{\phi \in \Gamma} V_\phi^{n,N}((\vec{x}_{n-1}, \vec{a}_{n-1}), i).$$

**Theorem 8.10**

$$V^{n,N}((\vec{x}_{n-1}, \vec{a}_{n-1}), i) = W^{n,N}(i)$$

**Proof:** For  $n = N$  the proof is obvious since the myopic policy is best. Assume the theorem is true for  $k \geq n + 1$ . Consider any policy  $\phi$  taking action  $a^*$  followed by a policy  $\phi_j^*$  if  $X_{n+1} = j$ . Use the notation  $\vec{x}_{n-1} \vee i$  to denote  $(x_0, x_1, \dots, x_{n-1}, i)$  and  $\vec{a}_{n-1} \vee a^*$  to denote  $(a_0, a_1, \dots, a_{n-1}, a^*)$ . Hence, using the development at (8.3)

we see

$$\begin{aligned}
 & V_\phi^{n,N}((\vec{x}_{n-1}, \vec{a}_{n-1}), i) \\
 &= C(n, i, a^*) + \sum_{j \in \mathcal{S}} K_{ij}(n, a^*) V_{\phi_j^*}^{n+1,N}((\vec{x}_{n-1} \vee i, \vec{a}_{n-1} \vee a^*), j) \\
 &\quad \text{by the definition of } \phi_j^* \\
 &\geq C(n, i, a^*) + \sum_{j \in \mathcal{S}} K_{ij}(n, a^*) V^{n+1,N}((\vec{x}_{n-1} \vee i, \vec{a}_{n-1} \vee a^*), j) \\
 &\quad \text{since } V^{n+1,N} \text{ is the least possible cost} \\
 &= C(n, i, a^*) + \sum_{j \in \mathcal{S}} K_{ij}(n, a^*) W^{n+1,N}(j) \text{ by hypothesis} \\
 &\geq \min_a \{C(n, i, a) + \sum_{j \in \mathcal{S}} K_{ij}(n, a) W^{n+1,N}(j)\} \\
 &= W^{n,N}(i) \text{ by Theorem 8.4.}
 \end{aligned}$$

Taking the infimum over all policies in  $\Gamma$  it follows that

$$V^{n,N}((\vec{x}_{n-1}, \vec{a}_{n-1}), i) \geq W^{n,N}(i).$$

Finally, since the Markovian policies in  $\Gamma$  are only a subset of the policies in  $\Gamma$ , the reverse inequality is automatic. ■

One might imagine, for instance, that in the buffer control example the input stream is not Bernoulli so the interarrival time between queries is not geometric. Without the memoryless property the transitions from state to state are no longer Markovian! One might also imagine that it might be impossible to change from rejecting queries to accepting queries in fewer than 10 time units. This delay means the action space depends on the actions in the past. Finally, one might imagine that the cost of queueing queries is dependent on the time since last taking the action of rejecting a query. None of these cases can be treated with the theory developed so far.

On the other hand, it is not hard to see the above theory could be extended to these cases. If the transition to the next state is no longer Markovian then the transition from time period  $t$  to  $t + 1$ , given action  $a$  is taken, is of the form

$$P(X_{t+1} = j | \vec{X}_t = \vec{x}_t, \vec{A}_t = \vec{a}_{t-1} \vee a)$$

and the associated cost is  $C(t, \vec{x}_t, \vec{a}_{t-1}, a)$ . Moreover, if the actions available depend on the entire past, the action space at time  $t$  might be  $\mathcal{A}(\vec{x}_t, \vec{a}_{t-1})$ , but we shall assume for simplicity that these actions are all contained in a finite set  $\mathcal{A}$ . As before, a policy  $\phi \in \Phi$  assigns action  $A_t$  at time  $t$  dependent on the entire past:  $A_t = \phi^{t,N}(\vec{X}_t, \vec{A}_{t-1})$ . Once a policy is given the stochastic processes,  $X_t$  and  $A_t$

are determined, and we may try to minimize

$$E_\phi \sum_{t=0}^N C(t, X_t, A_t).$$

This can be done with backwards induction. We first generalize the problem. Instead of just looking at the cost from time 0 to time  $N$  we consider a whole sequence of minimization problems. Given the past to time  $n$ , the cost of the policy  $\phi$  from time  $n$  to time  $N$  is

$$V_\phi^{n,N}(\vec{x}_n, \vec{a}_{n-1}) = E_\phi \left[ \sum_{t=n}^N C(t, X_t, A_t) \mid \vec{X}_n = \vec{x}_n, \vec{A}_{n-1} = \vec{a}_{n-1} \right].$$

If we can minimize  $V_\phi^{n,N}(\vec{x}_n, \vec{a}_{n-1})$  with  $n = 0$  then we have a solution. ( $\vec{a}_{-1}$  means no information is given.)

Clearly, if  $\phi^{n,N}(\vec{x}_n, \vec{a}_{n-1}) = a$  then

$$\begin{aligned} &V_\phi^{n,N}(\vec{x}_n, \vec{a}_{n-1}) \\ &= C(n, \vec{x}_n, \vec{a}_{n-1} \vee a) + E_\phi \left[ \sum_{t=n+1}^N C(t, X_t, A_t) \mid \vec{X}_n = \vec{x}_n, \vec{A}_n = \vec{a}_{n-1} \vee a \right] \\ &= C(n, \vec{x}_n, \vec{a}_{n-1} \vee a) + \sum_{j \in \mathcal{S}} P_\phi(X_{n+1} = j \mid \vec{X}_n = \vec{x}_n, \vec{A}_n = \vec{a}_{n-1} \vee a) \\ &\quad \cdot E_\phi \left[ \sum_{t=n+1}^N C(t, X_t, A_t) \mid \vec{X}_{n+1} = \vec{x}_n \vee j, \vec{A}_n = \vec{a}_{n-1} \vee a \right] \\ &= C(n, \vec{x}_n, \vec{a}_{n-1} \vee a) + \sum_{j \in \mathcal{S}} P_\phi(X_{n+1} = j \mid \vec{X}_n = \vec{x}_n, \vec{A}_n = \vec{a}_{n-1} \vee a) \\ &\quad \cdot V_\phi^{n+1,N}(\vec{x}_n \vee j, \vec{a}_{n-1} \vee a). \end{aligned}$$

The optimal cost associated with policies in  $\Phi$  is

$$V^{n,N}(\vec{x}_n, \vec{a}_{n-1}) = \inf_{\phi \in \Phi} V_\phi^{n,N}(\vec{x}_n, \vec{a}_{n-1}).$$

Repeating the above arguments, we can establish Bellman's equation in this generalized setting

$$V^{n,N}(\vec{x}_n, \vec{a}_{n-1}) = \min_{a \in \mathcal{A}(n, \vec{x}_n)} \{C(n, \vec{x}_n, \vec{a}_{n-1}, a) + F^{n+1,N}\},$$

where the minimum costs beyond time  $n + 1$  are given by  $F^{n+1,N}$ ,

$$F^{n+1,N} = \sum_{j \in \mathcal{S}} P(X_{n+1} = j \mid \vec{X}_n = \vec{x}_n, \vec{A}_n = \vec{a}_{n-1} \vee a) V^{n+1,N}(\vec{x}_n \vee j, \vec{a}_{n-1} \vee a)$$

and where

$$V^{N,N}(\vec{x}_N, \vec{a}_{N-1}) = \min_{a \in \mathcal{A}(N, x_N)} \{C(N, \vec{x}_N, \vec{a}_{N-1} \vee a)\}.$$

Unfortunately Bellman's equation is nearly useless in the general situation! Suppose we wanted to minimize some cost for the buffer control example given that we start with an empty queue. To begin the backward induction we have to store in computer memory all the values  $W^{N,N}(\vec{x}_N, \vec{a}_{N-1})$  for all the trajectories and actions  $(\vec{x}_N, \vec{a}_{N-1})$  such that  $0 \leq x_N, y_N \leq N$ . This is an enormous number of possibilities and too much for the computer. Unless we can write down some kind of formula we are stuck!

### 8.3 Infinite Horizon Decision Problems

We now consider infinite horizon problems. Such problems make sense only if there exist policies which have a finite expected total cost. One category of infinite horizon problem involves discounted costs. If we suppose (rather unrealistically) that the interest rate  $r$  is constant, a dollar earned today will be worth  $(1+r)$  dollars next year. Conversely a dollar earned next year has a present value of only  $\alpha := 1/(1+r)$  dollars today. Similarly a dollar earned  $t$  years (or periods) from now has a present value of only  $\alpha^t$  dollars. Now suppose the cost associated with a decision  $a$  while in state  $i$  at time  $t$  is given by

$$C(t, i, a) := \alpha^t C(i, a).$$

This is just the present value of  $C(i, a)$  dollars earned at time  $t$ .

We shall assume that if we are in state  $i$  at any time  $t$  then we can make a decision  $a \in \mathcal{A}$ , where  $\mathcal{A}$  is a finite fixed set and we jump to state  $j$  with probability  $K_{ij}(a)$  which does not depend on  $t$ . Given a policy  $\phi$  this transition kernel determines a Markov chain  $X_t$  and we are interested in minimizing the expected value of the present value of the total cost associated with policies  $\phi \in \Gamma$  which satisfy

$$E_\phi \sum_{t=0}^{\infty} \alpha^t C(X_t, A_t)^+ < \infty.$$

For simplicity we will assume in this section that  $|C(i, a)| \leq \bar{C}$  for all states  $i$  and all actions  $a$  so all policies are in  $\Gamma$ .

First, we artificially impose a horizon  $N$  and as before we define  $W^{n,N}(i)$  to be the minimal cost from time  $n$  to the horizon. From the Bellman optimality equation we have

$$W^{n,N}(i) = \min_{a \in \mathcal{A}} \left\{ \alpha^n C(i, a) + \sum_{j \in S} K_{ij}(a) W^{n+1,N}(j) \right\}$$

$$W^{N,N}(i) = \min_{a \in \mathcal{A}} \{\alpha^N C(i, a)\}.$$

Let  $U^{n,N}(i)$  denote the future value of the minimal cost from time  $n$  to the horizon. Hence  $U^{n,N}(i) = \alpha^{-n} W^{n,N}(i)$ . We may, therefore, rewrite the Bellman optimality equation as

$$U^{n,N}(i) = \min_{a \in \mathcal{A}} \left\{ C(i, a) + \alpha \sum_{j \in \mathcal{S}} K_{ij}(a) U^{n+1,N}(j) \right\}$$

$$U^{N,N}(i) = \min_{a \in \mathcal{A}} \{C(i, a)\}. \quad (8.5)$$

Let  $\mathcal{B}$  represent the set of bounded real valued functions defined on the state space  $\mathcal{S}$ . We define a map of  $\mathcal{B}$  into itself as follows: for  $f \in \mathcal{B}$  define  $Tf$  by

$$Tf(i) := \min_{a \in \mathcal{A}} \left\{ C(i, a) + \alpha \sum_{j \in \mathcal{S}} K_{ij}(a) f(j) \right\}.$$

Clearly, for  $n < N$ , we may write the above Bellman optimality equation as  $U^{n,N} = TU^{n+1,N}$ . By recursion we have

$$U^{n,N} = T^{N-n} U^0 \quad \text{where } U^0 \equiv U^{N,N}$$

so  $U^0(i) = \min_{a \in \mathcal{A}} \{C(i, a)\}$  is a function in  $\mathcal{B}$  which we can calculate.

**Lemma 8.11**  *$T$  is a contraction operator on  $\mathcal{B}$  with respect to the supremum norm:  $\|u\| = \sup_{i \in \mathcal{S}} |u(i)|$ .*

**Proof:** Simply consider  $u, v \in \mathcal{B}$ . For any given  $i$  pick action  $\bar{a}$  so that

$$Tv(i) = C(i, a^*) + \alpha \sum_{j \in \mathcal{S}} K_{ij}(a^*) v(j).$$

Hence,

$$\begin{aligned} & Tu(i) - Tv(i) \\ &= \left[ \min_{a \in \mathcal{A}} \{C(i, a) + \alpha \sum_{j \in \mathcal{S}} K_{ij}(a) u(j)\} \right] - \left[ C(i, a^*) + \alpha \sum_{j \in \mathcal{S}} K_{ij}(a^*) v(j) \right] \\ &\leq \alpha \sum_{j \in \mathcal{S}} K_{ij}(a^*) [u(j) - v(j)] \\ &\quad \text{taking } a = a^* \text{ in the first term of the above} \\ &\leq \alpha \sum_{j \in \mathcal{S}} K_{ij}(a^*) |u(j) - v(j)| \\ &\leq \alpha \sum_{j \in \mathcal{S}} K_{ij}(a^*) \cdot \sup_{k \in \mathcal{S}} |u(k) - v(k)| \\ &= \alpha \|u - v\|. \end{aligned}$$

By symmetry it also follows that

$$Tv(i) - Tu(i) \leq \alpha \|u - v\|$$

so we conclude

$$|Tu(i) - Tv(i)| \leq \alpha \|u - v\|. \quad (8.6)$$

Next,

$$\begin{aligned} \|Tu - Tv\| &= \sup_{i \in \mathcal{S}} |Tu(i) - Tv(i)| \\ &\leq \sup_{i \in \mathcal{S}} \alpha \|u - v\| \text{ by (8.6)} \\ &= \alpha \|u - v\|. \end{aligned}$$

We conclude that  $T$  is indeed a contraction map. ■

Clearly  $W^{0,N} = U^{0,N} = T^N U^0$ . By the fixed point theorem in the Appendix we know  $T^N U^0$  converges in the supremum norm, that is uniformly in  $i \in \mathcal{S}$ , as  $N \rightarrow \infty$ , to the unique fixed point of  $T$ . Denote this fixed point by  $W$  so

$$W(i) = \min_{a \in \mathcal{A}} \left\{ C(i, a) + \alpha \sum_{j \in \mathcal{S}} K_{ij}(a) W(j) \right\}. \quad (8.7)$$

Since  $|C(i, a)| \leq \bar{C}$  the expected total cost of any policy is finite. Consequently the costs associated with any policy beyond time  $N$  are less than  $\epsilon$  for  $N$  large. Consequently, the optimal strategy starting from state  $i$  will have a cost no more than  $W^{0,N}(i) + \epsilon$  since  $W^{0,N}$  is the minimum cost associated with the horizon  $N$ . But as  $N \rightarrow \infty$ ,  $W^{0,N}(i) = T^N U^0(i)$  is arbitrarily close to  $W(i)$  so we conclude  $W(i)$  is the cost of the optimal strategy starting from state  $i$ .

What is this optimal strategy?

**Definition 8.12** The stationary, Markovian policy  $\sigma$  takes action  $\sigma(i)$  whenever the state is  $i$ , where  $\sigma(i)$  minimizes the right hand side of (8.7).

Let  $W_\sigma$  represent the expected cost associated with this policy. Hence,

$$\begin{aligned} W_\sigma(i) &= E_\sigma \left( \sum_{t=0}^{\infty} \alpha^t C(X_t, A_t) | X_0 = i \right) \\ &= C(i, \sigma(i)) + E_\sigma \left( \sum_{t=1}^{\infty} \alpha^t C(X_t, A_t) | X_0 = i \right) \\ &= C(i, \sigma(i)) + \sum_{j \in \mathcal{S}} K_{ij}(\sigma(i)) E_\sigma \left( \sum_{t=1}^{\infty} \alpha^t C(X_t, A_t) | X_0 = i, X_1 = j \right) \\ &= C(i, \sigma(i)) + \alpha \sum_{j \in \mathcal{S}} K_{ij}(\sigma(i)) E_\sigma \left( \sum_{m=0}^{\infty} \alpha^m C(X_m, A_m) | X_0 = j \right) \end{aligned}$$

using the Markov property and changing the index of summation. But

$$W_\sigma(j) = E_\sigma \left( \sum_{m=0}^{\infty} \alpha^m C(X_m, A_m) | X_0 = j \right)$$

so  $W_\sigma$  satisfies

$$W_\sigma(i) = C(i, \sigma(i)) + \alpha \sum_{j \in \mathcal{S}} K_{ij}(\sigma(i)) W_\sigma(j).$$

Now define a new transformation on  $u \in \mathcal{B}$  by

$$T_\sigma u(i) := C(i, \sigma(i)) + \alpha \sum_{j \in \mathcal{S}} K_{ij}(\sigma(i)) u(j).$$

It is easy to see  $T_\sigma$  is also a contraction operator and  $W_\sigma$  is the unique fixed point. However, from (8.7),

$$W(i) = C(i, \sigma(i)) + \alpha \sum_{j \in \mathcal{S}} K_{ij}(\sigma(i)) W(j) = T_\sigma W(i)$$

which means  $W = T_\sigma W$ . However  $W_\sigma$  is the unique fixed point of  $T_\sigma$ . Hence  $W = W_\sigma$ ; i.e. policy  $\sigma$  is optimal.

We summarize our results.

**Theorem 8.13** *The optimal policy  $\sigma$  is a stationary, Markovian policy which, when in state  $i$ , has associated cost  $W(i)$  and prescribes action  $\sigma(i)$  where  $\sigma(i)$  minimizes the right hand side of the Bellman optimality equation*

$$W(i) = \min_{a \in \mathcal{A}} \{ C(i, a) + \alpha \sum_{j \in \mathcal{S}} K_{ij}(a) W(j) \}.$$

**Example 8.14 Buffer control - (8.7) continued**

Suppose we consider the buffer control problem without a horizon but with a discount factor  $\alpha$ . Let  $W_\sigma(x)$  denote the minimum cost or total delay assuming we start with  $x \geq 0$  queries in the queue. The Bellman optimality equation becomes

$$W_\sigma(x) = \min \{ Cx + \alpha T_0[W_\sigma](x), Cx + pM + \alpha T_1[W_\sigma](x) \} \quad (8.8)$$

where  $T_0$  and  $T_1$  are defined in Example 8.7.

Define an operator  $T$  on functions defined on the nonnegative integers by

$$Tu(x) = \min \{ Cx + \alpha T_0[u](x), Cx + pM + \alpha T_1[u](x) \}.$$

We have seen above that this is a contraction *but* it is not true that if  $u \in \mathcal{B}$  then  $Tu \in \mathcal{B}$ . For instance if  $u = 0$  then  $Tu(x) = Cx$  and this is not bounded. Hence the above theory does not apply!

It is possible to construct a weaker norm to enlarge the space  $\mathcal{B}$  so that  $T$  is still a contraction on  $\mathcal{B}$ . However we will simply change the cost function. Define

$$C(x, 0) = \begin{cases} Cx & \text{for } x < x_U, \\ \bar{C} & \text{for } x \geq x_U \end{cases} \quad \text{and} \quad C(x, 1) = \begin{cases} Cx + pM & \text{for } x < x_U, \\ \bar{C} & \text{for } x \geq x_U. \end{cases}$$

We will assume  $\bar{C} > Mp + Cx_U$ . Redefine the operator  $T$  by

$$Tu(x) = \min\{C(x, 0) + \alpha T_0[u](x), C(x, 1) + \alpha T_1[u](x)\}.$$

Now the theory applies and  $\lim_{n \rightarrow \infty} T^n u(x) = W_\sigma(x)$ .

There is, moreover, a stationary optimal policy and this means there is a smallest  $x_R$  such that it is optimal to reject queries when the queue builds up to  $x_R$  queries. We can therefore reduce our problem to the finite state space  $S_0 = \{x : 0 \leq x \leq x_R\}$  since starting with an empty queue we will never exceed  $x_R$  queries. Finally we remark that if  $x_U$  is taken bigger than  $x_R$  then under the above optimal policy  $C(X_n, 0) = CX_n$  and  $C(X_n, 1) = CX_n + pM$  for all  $n$ . This means that we have also discovered the optimal policy for the unbounded cost problem.

A discount factor and the equivalent interest rate focuses attention on short term policies. One might prefer a policy which minimizes the long run average cost. Consider a time homogeneous Markov decision problem. For any policy  $\phi$ , define

$$A_\phi(i) = \limsup_{N \rightarrow \infty} \frac{E_\phi \left[ \sum_{t=0}^N C(X_t, A_t) \right]}{N + 1}.$$

$A_\phi(i)$  represents the average expected cost for the policy  $\phi$  starting from state  $i$ . Now consider the associated Markov decision problem with discount rate  $\alpha$  which has a minimum expected cost  $W_\alpha(i)$ , where we replace the index  $\sigma$  by  $\alpha$  to remind us of the discount rate.  $W_\alpha$  satisfies the Bellman optimality equation

$$W_\alpha(i) = \min_{a \in \mathcal{A}} \{C(i, a) + \alpha \sum_{j \in \mathcal{S}} K_{ij}(a) W_\alpha(j)\}.$$

When the discount rate  $\alpha$  tends to 1, the short term costs become less and less important so it seems reasonable that the optimal decision for such a discounted problem should be close to the optimal decision for the long run average expected cost problem.

To establish this, define the function  $r_\alpha(i) = W_\alpha(i) - W_\alpha(i_0)$  where  $i_0$  is some fixed state. Subtracting  $\alpha W_\alpha(i_0)$  from both sides of Bellman's equation we get

$$(1 - \alpha)W_\alpha(i_0) + r_\alpha(i) = \min_{a \in \mathcal{A}} \{C(i, a) + \alpha \sum_{j \in \mathcal{S}} K_{ij}(a) r_\alpha(j)\}. \quad (8.9)$$



Assuming  $r_\alpha(i) \rightarrow r(i)$  for each  $i$  as  $\alpha \rightarrow 1$ , it follows by taking the limit of (8.9) that the limit  $A := \lim_{\alpha \rightarrow 1} (1 - \alpha)W_\alpha(i_0)$  exists. Moreover,

$$A + r(i) = \min_{a \in \mathcal{A}} \{C(i, a) + \sum_{j \in \mathcal{S}} K_{ij}(a)r(j)\}.$$

If we have the candidates  $r(i)$  and  $A$  then we can find the optimal policy.

**Theorem 8.15** *Suppose there exists a constant  $A$  and function  $r$  such that for all policies  $\phi$  and all initial states  $i$ ,*

$$\lim_{N \rightarrow \infty} E_\phi r(X_N)/N = 0$$

and

$$A + r(i) = \min_{a \in \mathcal{A}} \{C(i, a) + \sum_{j \in \mathcal{S}} K_{ij}(a)r(j)\}. \tag{8.10}$$

*Then the stationary policy  $\psi$  which takes the action minimizing the above expression is such that*

$$A = A_\psi(i) = \inf_\phi A_\phi(i) \text{ for all states } i.$$

*The  $r(i)$  are only determined up to an additive constant so we can fix  $r(i_0) = 0$  for some chosen state  $i_0$ .*

**Proof:** Let  $\phi$  represent any policy and as usual, let  $\vec{X}_t, \vec{A}_t$  denote the history to time  $t$ . Note that

$$\begin{aligned} E_\phi(r(X_t)|X_{t-1} = i, A_{t-1} = a) &= \sum_j K_{ij}(a)r(j) \\ &= \{C(i, a) + \sum_j K_{ij}(a)r(j)\} - C(i, a) \\ &\geq \min_{a \in \mathcal{A}} \{C(i, a) + \sum_{j \in \mathcal{S}} K_{ij}(a)r(j)\} - C(i, a) \\ &= A + r(i) - C(i, a) \end{aligned}$$

and the above is an equality if  $a = \psi(i)$ . Hence,

$$E_\phi(r(X_t)|X_{t-1}, A_{t-1}) \geq A + r(X_{t-1}) - C(X_{t-1}, A_{t-1})$$

with equality if  $\phi = \psi$ . Now since

$$E_\phi [E_\phi(r(X_t)|X_{t-1}, A_{t-1})] = E_\phi r(X_t)$$

it follows that

$$E_\phi [r(X_t) - (A + r(X_{t-1}) - C(X_{t-1}, A_{t-1}))] \geq 0$$

with equality if  $\phi = \psi$ . Summing from  $t = 1$  to  $N$  and telescoping we get

$$E_\phi \sum_{t=1}^N C(X_{t-1}, A_{t-1}) + E_\phi r(X_N) - E_\phi r(X_0) \geq NA$$

with equality if  $\phi = \psi$ . Adding the initial term  $C(i, A_0)$ , if the initial state is  $i$ , and dividing by  $N + 1$  we get

$$A_\phi(i) \geq A$$

since by hypothesis  $E_\phi r(X_N)/N \rightarrow 0$ . Also, since we have equality if  $\phi = \psi$  it follows that  $A_\psi(i) = A$ . ■

The preceding theory calls for the construction of the constant  $A$  and the function  $r$ . If this can be done by directly solving equations (8.10) then the problem is solved. Unfortunately this is often not possible and one first tries to prove a solution exists. Our intuitive explanation of the theorem and equation (8.9) suggests

$$r(i) = \lim_{\alpha \rightarrow 1} W_\alpha(i) - W_\alpha(i_0) \text{ and } A = \lim_{\alpha \rightarrow 1} (1 - \alpha)W_\alpha(i_0).$$

To best understand when these limits exist we will restrict ourselves to studying our queueing example. We could formulate a general theorem based on this example. The key is finding an a priori bound on  $W_\alpha(x) - W_\alpha(0)$  which is uniform in  $\alpha$ . However, each case usually has its own special twist so let's be satisfied with this.

### Example 8.16 Buffer control - (8.14) continued

In this example  $i_0 = 0$  and we know  $W_\alpha(i) \geq W_\alpha(0)$ . If we define  $\tau$  to be the first  $t$  such that  $X_t = 0$ , we can decompose the costs of the optimal policy  $\sigma$  as before and after time  $\tau$  so

$$W_\alpha(x) = E_\sigma \left[ \sum_{t=0}^{\tau-1} \alpha^t C(X_t, A_t) + \alpha^\tau W_\alpha(0) \mid X_0 = x \right].$$

Hence, since  $\alpha \leq 1$  and  $C(x, 0)$  and  $C(x, 1)$  positive and less than  $Cx + pM$  we have

$$\begin{aligned} W_\alpha(x) - W_\alpha(0) &\leq (C + pM) E_\sigma \sum_{t=0}^{\tau-1} X_t - E_\sigma (1 - \alpha^\tau) W_\alpha(0) \\ &\leq (C + pM) E_\sigma \sum_{t=0}^{\tau-1} X_t. \end{aligned}$$

Let policy  $\nu$  be the policy of always accepting a query. Under the policy  $\nu$  the process  $X_t$  is stochastically larger than under  $\sigma$ . To show this just define a joint transition kernel for a pair of chains  $(Y_t, Y'_t)$  whose marginal distributions are those of  $X_t$  under the policy  $\sigma$  and  $\nu$  respectively. The two chains will be forced to stick together as much as possible but otherwise the chain  $Y'$  jumps to the right of  $Y$ .

Now define  $\tau$  to be the first time  $t$  when  $Y_t = 0$  and let  $\tau'$  be the first time  $Y'_t$  hits 0. Clearly,

$$E_\sigma[\tau] = E_{(x,x)}\tau \leq E_{(x,x)}\tau' = E_\nu\tau.$$

Similarly,

$$\begin{aligned} E_\sigma\left[\sum_{t=0}^{\tau-1} X_t | X_0 = x\right] &= E_{(x,x)} \sum_{t=0}^{\tau-1} Y_t \\ &\leq E_{(x,x)} \sum_{t=0}^{\tau'-1} Y'_t = E_\nu\left[\sum_{t=0}^{\tau-1} X_t | X_0 = x\right]. \end{aligned}$$

We conclude that

$$W_\alpha(x) - W_\alpha(0) \leq (C + pM)f(x) \text{ where } f(x) := E_\nu\left[\sum_{t=0}^{\tau-1} X_t | X_0 = x\right].$$

$f(x)$  satisfies  $f(0) = 0$  and by the Markov property

$$f(x) = x + q(1 - p)f(x - 1) + (pq + (1 - p)(1 - q))f(x) + p(1 - q)f(x + 1).$$

By inspection the unique solution to the above is

$$f(x) = \frac{q(1 - p) - p(1 - q)}{2}x^2 + \frac{q(1 - p) + p(1 - q)}{q(1 - p) - p(1 - q)}x.$$

Hence, uniformly in  $\alpha$ ,

$$0 \leq W_\alpha(x) - W_\alpha(0) \leq M(x) = (C + pM)f(x).$$

Since  $W_\alpha(x) - W_\alpha(0)$  is bounded for each  $x$ , we may pick a subsequence of  $\alpha$ 's such that  $W_\alpha(x) - W_\alpha(0)$  converges for each  $x$ . The technique to do this is the Cauchy diagonalization method. Start with  $x = 1$ . Pick a convergent subsequence  $\alpha_{1n}$  for  $n = 1, \dots$  for  $W_\alpha(1) - W_\alpha(0)$  using the Bolzano-Weierstrass theorem. Of this subsequence pick a subsequence  $\alpha_{2n}$  for  $n = 1, \dots$  where  $W_\alpha(2) - W_\alpha(0)$  converges and on and on. Now consider the subsequence  $\alpha_{nn}$ . On this subsequence all the  $W_\alpha(x) - W_\alpha(0)$  converge to a finite limit which we call  $r(x)$ . Note that  $W_\alpha(x)$  is increasing by Example 8.14. These properties are preserved in the limit as  $\alpha \rightarrow 1$  so  $r(x)$  is increasing and by construction  $r(x) \leq (C + pM)f(x)$ .

Clearly, in this case, the right hand side of (8.9) converges to

$$\min\left\{Cx \sum_y K_{xy}(0)r(y), Cx + pM + \sum_y K_{xy}(1)r(y)\right\}$$

since the kernel  $K$  admits jumps to at most two states. The left hand side of (8.9) must, therefore, also converge so  $(1 - \alpha)W_\alpha(i_0)$  has a limit which we call  $A$ . The key to this calculation is the a priori bound on  $W_\alpha(x) - W_\alpha(0)$  which is uniform in  $\alpha$  (but not necessarily in  $x$ ).

To apply Theorem 8.15 we need only check

$$\lim_{N \rightarrow \infty} E_\phi[r(X_N)/N | X_0 = x] = 0$$

for any policy  $\phi$ . Since  $r(x)$  is increasing, it is clear it suffices to show

$$\lim_{N \rightarrow \infty} E_\nu[r(X_N)/N | X_0 = x] = 0 \text{ or } \lim_{N \rightarrow \infty} E_\nu[M(X_N)/N | X_0 = x] = 0.$$

Under the stationary policy  $\nu$ , the Markov chain is positive recurrent so when  $N$  is big the distribution of  $X_N$  tends to the stationary distribution  $\pi$  given in Example 5.28 on the discrete  $M|M|1$  queue. The tail of the distribution  $\pi$  decreases exponentially like  $\rho^x \sim (((1-q)p)/((1-p)q))^x$ . Hence, if  $K$  is the transition kernel of an  $M|M|1$  queue,

$$E_\nu[M(X_N)/N | X_0 = x] = \sum_y M(y) K_{x,y}^N = \sum_y M(y) \frac{K_{x,y}^N}{\pi(y)} \pi(y) \rightarrow \sum M(y) \pi(y)$$

by dominated convergence since  $K_{x,y}^N/\pi(y) \leq 1/\pi(x)$  by (5.7) and the quadratic function  $M(x)$  is integrable with respect to  $\pi$  which has an exponential tail. It follows that  $\lim_{N \rightarrow \infty} E_\phi[M(X_N)/N | X_0 = x] = 0$ .

We have therefore established the conditions of Theorem 8.15, so there exists a stationary policy  $\psi$  which minimizes

$$\limsup_{N \rightarrow \infty} \frac{E_\phi \left[ \sum_{t=0}^N C(X_t, A_t) \right]}{N+1}.$$

among all policies  $\phi$ . As before there must be a threshold  $x_R$  where it is optimal to drop queries.

We can calculate this optimal threshold directly using Theorem 5.18. This threshold may make some kind of sense for suggesting an optimal buffer size. The long run expected average delay is just  $C$  times the expected queue size plus  $Mp$  times the probability the queue size is  $x_R$ . The nearest neighbor transition rates are approximately  $p = \lambda/\eta$  for an increase of 1 and  $q = \mu/\eta$  for a decrease of 1 if we take a time unit to be  $\eta = C$ . The steady state probability the unbounded queue holds  $x$  queries is approximately  $\pi_R(x) = (1-\rho)\rho^x$  where  $\rho = \lambda/\mu$  as seen in Example 5.28. Since the  $M|M|1$  queue is time reversible the steady state for the threshold limited queue is given by

$$\pi_R(x) = \frac{\pi(x)}{\sum_{x=0}^{x_R} \pi(x)} = \frac{\pi(x)}{(1-\rho^{x_R+1})} = \frac{(1-\rho)}{(1-\rho^{x_R+1})} \rho^x.$$

Consequently the long run expected average delay is

$$\begin{aligned}
 & C \sum_{x=0}^{x_R} x \pi_R(x) + pM \pi_R(x_R) \\
 &= C \frac{1}{(1 - \rho^{x_R+1})} \sum_{x=0}^{x_R} x(1 - \rho)\rho^x + Mp \frac{(1 - \rho)}{(1 - \rho^{x_R+1})} \rho^{x_R}.
 \end{aligned}$$

Also,  $\sum_{x=0}^{x_R} x(1 - \rho)\rho^x = \frac{\rho}{1 - \rho}(1 - x_R \rho^{x_R-1} + (x_R - 1)\rho^{x_R})$ .

Typically  $M$  is given by a round trip time for a query which might be a million times greater than the time to service a query. Hence  $M = 10^6/q$  so  $pM/C = 10^6 \lambda/\mu$ . Therefore we want to minimize

$$\frac{1}{(1 - \rho^{x_R+1})} \frac{\rho}{1 - \rho} (1 - x_R \rho^{x_R-1} + (x_R - 1)\rho^{x_R}) + \rho 10^6 \frac{(1 - \rho)}{(1 - \rho^{x_R+1})} \rho^{x_R}.$$

For large  $x_R$  the first term is practically invariant and equal to  $\rho/(1 - \rho)$  so it is essentially optimal to chose  $x_R$  to make these two terms approximately equal. Therefore take  $\frac{\rho}{1 - \rho} \approx \rho 10^6 (1 - \rho) \rho^{x_R}$ ; i.e.  $\rho^{x_R} \approx 10^{-6}/(1 - \rho)^2$ .

### 8.4 Continuous Time Decision Problems

Let us turn to approximating these discrete decision problems by continuous time problems. Suppose that units of time are measured in nanoseconds and that the discount rate per time unit is  $1 - \beta/\eta$ . We suppose that the cost of an action  $a$  in state  $i$  is  $C(i, a)/\eta$  and that, to first order, the transition kernel is  $I + G(a)/\eta$ . Substituting into the Bellman optimality equation we see that to first order the minimum cost satisfies

$$W(i) = \min_{a \in \mathcal{A}} \{ C(i, a)/\eta + (1 - \beta/\eta) \sum_{j \in \mathcal{S}} [I_{ij} + G_{ij}(a)/\eta] W(j) \}.$$

Hence, eliminating higher order terms and multiplying through by  $\eta$  we get

$$\beta W(i) = \min_{a \in \mathcal{A}} \{ C(i, a) + \sum_{j \in \mathcal{S}} G_{ij}(a) W(j) \}. \tag{8.11}$$

Remark that the optimal policy is stationary and so once we enter state  $i$  the same action is taken until a jump occurs.

Define  $q = \max_{i,a} \{q_i(a) \equiv -G_{ii}(a)\}$  and define the transition kernel of the Markov process with uniform jump rate  $q$ :

$$\tilde{K}_{ii}(a) = 1 - \frac{q_i(a)}{q} \text{ and } \tilde{K}_{ij}(a) = \frac{q_i(a)}{q} K_{ij}(a), \quad i \neq j$$

where  $K_{ij}(a) = G_{ij}(a)/q_i(a)$  if  $i \neq j$  and  $K_{ii}(a) = 0$ . Now rewriting (8.11) we see

$$(\beta + q)W(i) = \min_{a \in \mathcal{A}} \left\{ C(i, a) + q \sum_{j \in \mathcal{S}} \tilde{K}_{ij}(a)W(j) \right\}.$$

Dividing by  $(\beta + q)$  we get

$$W(i) = \min_{a \in \mathcal{A}} \left\{ \frac{C(i, a)}{\beta + q} + \alpha \sum_{j \in \mathcal{S}} \tilde{K}_{ij}(a)W(j) \right\} \tag{8.12}$$

where  $\alpha := q/(\beta + q)$ . Hence, we have replaced the continuous time problem by another discrete time problem.

To better understand equation (8.12) consider the continuous time optimization problem that approximates the original discrete problem. Let  $Y_t$  denote a uniformized Markov process with constant jump rate  $q$  and transition kernel  $\tilde{K}$ .  $Y_t$  closely approximates the original discrete time chain on the nanoseconds. The cost associated with an action  $a$  taken at time  $t$  is

$$(1 - \beta/\eta)^{\eta t} C(X_t, a)/\eta \sim \exp(-\beta t) C(Y_t, a)/\eta$$

so as  $\eta \rightarrow \infty$  the expected discounted cost of a policy  $\phi$  starting from state  $i$  is

$$W_\phi(i) \sim E_\phi \int_0^\infty \exp(-\beta t) C(Y_t, A_t) dt.$$

This cost can be broken down into the costs incurred between jumps. Let  $\tau_n$  denote the time of the  $n^{th}$  nonfictitious jump; that is a jump from one state to a different state. Let  $\tau_0 = 0$ . Assuming the policy  $\phi$  is stationary in the sense that the action remains the same until a jump, it follows that

$$\begin{aligned} W_\phi(i) &= E_\phi \sum_{n=0}^\infty \exp(-\beta \tau_n) \int_{\tau_n}^{\tau_{n+1}} \exp(-\beta t) C(Y_t, A_t) dt \\ &= E_\phi \sum_{n=0}^\infty \exp(-\beta \tau_n) \frac{C(Y_{\tau_n}, A_{\tau_n})}{\beta + q} = \sum_{n=0}^\infty E_\phi \exp(-\beta \tau_n) E_\phi \frac{C(Y_{\tau_n}, A_{\tau_n})}{\beta + q} \\ &= E_\phi \sum_{n=0}^\infty \left( \frac{q}{\beta + q} \right)^n \frac{C(Y_{\tau_n}, A_{\tau_n})}{\beta + q} \end{aligned}$$

since the jump times for the uniformized Markov chain occur after i.i.d. exponential times independent of the state of the chain. Letting  $\alpha = q/(q + \beta)$  and  $M_n = Y_{\tau_n}$  be the state of the jump chain, we see

$$W_\phi(i) = E_\phi \sum_{n=0}^\infty \alpha^n \frac{C(M_n, A_n)}{\beta + q}.$$

The minimum cost  $W_\sigma$  for this problem, given by the optimal policy  $\sigma$ , satisfies the Bellman optimality equation:

$$W_\sigma(i) = \min_{a \in \mathcal{A}} \left\{ \frac{C(i, a)}{\beta + q} + \alpha \sum_{j \in \mathcal{S}} \tilde{K}_{ij}(a) W_\sigma(j) \right\}.$$

This is precisely equation (8.12).

The uniformized Markov process  $Y_t$  is equal to the Markov process  $X_t$ , having generator  $G$ , except for the introduction of fictitious jumps (from a state to itself) which have no associated cost. We have really shown equation (8.12) is a Bellman optimality equation for the continuous time minimization problem with costs:

$$E_\phi \int_0^\infty \exp(-\beta t) C(X_t, A_t) dt.$$

**Example 8.17 Buffer control - (8.16) continued**

Consider the cost associated with controlling an  $M|M|1$  queue with arrival rate  $\lambda$  and service rate  $\mu$ , when our control consists of accepting or rejecting queries. The delay of queuing  $x$  queries is  $Cx$  per unit time and cost of dropping a query is a delay of  $M$ . This problem approximates the discrete time problem discussed before when the arrival rate at the queue was  $p = \lambda/\eta$  and the service rate was  $q = \mu/\eta$ . The holding cost per nanosecond for  $x$  queries is  $Cx/\eta$  and the expected payment for accepting a query is  $pM = \lambda M/\eta$ . The total event rate  $v = \lambda + \mu$  and the effective discount rate is  $\alpha = (\lambda + \mu)/(\lambda + \mu + \beta)$ .

For action 0, when we accept queries, the kernel  $\tilde{K}_{x,x+1}(0) = \lambda/(\lambda + \mu)$  and  $\tilde{K}_{x,x-1}(0) = \mu/(\lambda + \mu)$ , except at  $x = 0$  when  $\tilde{K}_{00}(0) = \mu/(\lambda + \mu)$ . For action 1 when queries are rejected  $\tilde{K}_{xx}(1) = \lambda/(\lambda + \mu)$  and  $\tilde{K}_{x,x-1}(1) = \mu/(\lambda + \mu)$ , except at  $x = 0$  when  $\tilde{K}_{00}(1) = 1$ .

The Bellman optimality equation (8.12) gives

$$W_\sigma(x) = \min \left\{ \frac{Cx}{(\lambda + \mu + \beta)} + \alpha R_0[W_\sigma](x), \frac{Cx + \lambda M}{(\lambda + \mu + \beta)} + \alpha R_1[W_\sigma](x) \right\}$$

where  $R_0$  and  $R_1$  are

$$R_0[W_\sigma](x) = \frac{\lambda}{\lambda + \mu(x)} W_\sigma(x + 1) + \frac{\mu(x)}{\lambda + \mu(x)} W_\sigma(x - 1)$$

$$R_1[W_\sigma](x) = \frac{\lambda}{\lambda + \mu(x)} W_\sigma(x) + \frac{\mu(x)}{\lambda + \mu(x)} W_\sigma(x - 1)$$

where  $\mu(x) = \mu$  if  $x > 0$  and  $\mu(0) = 0$ . Once again the optimal policy is to start rejecting queries when the queue reaches some threshold.

## 8.5 Optimal Stopping

There is another natural class of infinite horizon problems. Consider a Markov decision problem such that for all  $t$ , the action set is  $\mathcal{A} = \{s, c\}$  where  $s$  means stop and  $c$  means continue. If at time  $t$  we are in state  $i$  when the action  $s$  is taken, we pay a stopping cost of  $C(t, i, s)$  and jump with probability 1 to a terminal absorbing state  $\Delta$ , where we stay paying no further costs. On the other hand, if the action  $c$  is taken, we pay a cost  $C(t, i, c)$  and then make a transition to state  $j$  with probability  $K_{ij}(t)$ . Hence, we continue to incur (possibly negative) costs if we do not stop. Such Markov decision problems are called optimal stopping problems.

A policy for an optimal stopping problem is simply a stopping time  $\tau$  which specifies the first time the action of stopping was taken. Note that for any stopping time  $\tau$ ,

$$\{\tau = n\} \in \sigma\{X_0, X_1, \dots, X_n; A_0, A_1, \dots, A_{n-1}\} = \sigma\{\vec{X}_{n-1}, \vec{A}_{n-1}, X_n\}$$

because any action is chosen according to the past. Denote the family of stopping times by  $\mathcal{T}$ . The cost associated with a stopping time  $\tau$  is

$$\sum_{t=0}^{\tau-1} C(t, X_t, c) + C(\tau, X_\tau, s)$$

where we assume  $C(\tau, X_\tau, s) = 0$  if  $\tau = \infty$ .

$$\begin{aligned} & V_\tau^n(\vec{x}_{n-1}, \vec{a}_{n-1}, i) \\ &= E \left[ \sum_{t=n}^{\tau-1} C(t, X_t, c) + C(\tau, X_\tau, s) \mid \vec{X}_{n-1} = \vec{x}_{n-1}, \vec{A}_{n-1} = \vec{a}_{n-1}, X_n = i \right] \end{aligned}$$

represents the cost beyond time  $n$  for the stopping policy  $\tau$ . Unless  $i = \Delta$  it is clear that  $\tau \geq n$  on the set  $\{X_n = i\}$ . By hypothesis,  $V_\tau^n(\vec{x}_{n-1}, \vec{a}_{n-1}, \Delta) = 0$  which means of course that  $\tau < n$ .

Our goal is to find the stopping time which minimizes

$$V_\tau(i) \equiv V_\tau^0(i) = E \left[ \sum_{t=0}^{\tau-1} C(t, X_t, c) + C(\tau, X_\tau, s) \mid X_0 = i \right].$$

In order that the expectation exists we will restrict attention to stopping times  $\tau \in \Gamma$  such that

$$E \left[ \sum_{t=0}^{\tau-1} C(t, X_t, c)^+ + C(\tau, X_\tau, s)^+ \mid X_0 = i \right] < \infty.$$

The policy of stopping immediately is clearly in  $\Gamma$ . Moreover, any practical stopping time will be uniformly bounded (as Keynes said "In the long run, we are all dead.")



so let  $\mathcal{T}^{n,N}$  represent the family of stopping times  $\tau \in \Gamma$  such that  $n \leq \tau \leq N$  and let  $\mathcal{T}^n = \cup_{N=n}^\infty \mathcal{T}^{n,N}$ . We will therefore consider

$$V(i) \equiv V^0(i) = \inf_{\tau \in \mathcal{T}^0} E \left( \sum_{t=0}^{\tau-1} C(t, X_t, c) + C(\tau, X_\tau, s) | X_0 = i \right).$$

**Example 8.18 Pathological Cases - (8.6) continued** Consider a gamble based on a fair coin. If the coin shows heads you win and tails you lose. The winner takes all. Suppose your opponent will accept any bet. You might consider the following strategy. Bet one dollar. If you win, stop but if you lose, bet two dollars. If you win, stop but if you lose, bet four dollars. Keep doubling your bet until you finally win. Let  $\tau$  be the number of tosses until a win. Let  $X_n, n = 1, 2, \dots$ , be i.i.d. random variables with equal probabilities of getting  $-1$  or  $1$ .  $X_n$  is Markov chain on the state space  $\{-1, 1\}$  determined by the action  $c$  to keep playing. Take  $X_0 = 0$  and head is represented by the state  $-1$ . Let  $C(n, X_n, c) = C(n, X_n, s) = X_n 2^n$ . The cost of the strategy of stopping at the first win is

$$\sum_{n=0}^{\tau} X_n 2^n = (1 + 2 + \dots + 2^{\tau-1}) - 2^\tau = -1$$

so this looks like a sure way to make a buck. This strategy is however ruled out because

$$E \sum_{n=0}^{\tau-1} (X_n 2^n)^+ = E(2^\tau - 1) = \sum_{k=0}^\infty 2^k \frac{1}{2^k} - 1 = \infty.$$

---

Our method is to approximate the infinite horizon problem with a finite horizon problem. First we define

$$V^n(\vec{x}_{n-1}, \vec{a}_{n-1}, i) = \inf_{\tau \in \mathcal{T}^n} V_\tau^n(\vec{x}_{n-1}, \vec{a}_{n-1}, i)$$

which represents the minimum expected cost of continuing beyond time  $n$ .

**Theorem 8.19** *The expected cost from time  $n$  to the horizon  $N$  associated with the optimal finite horizon Markovian policy  $\mu^{n,N} \in \mathcal{T}^{n,N}$ , given  $\vec{X}_{n-1} = \vec{x}_{n-1}, \vec{A}_{n-1} = \vec{a}_{n-1}$  and  $X_n = i$ , is*

$$W^{n,N}(i) = E \left[ \sum_{t=n}^{\mu^{n,N}-1} C(t, X_t, c) + C(\mu^{n,N}, X_{\mu^{n,N}}, s) | X_n = i \right].$$

Then

$$V^n(\vec{x}_{n-1}, \vec{a}_{n-1}, i) = W^n(i) \text{ where } W^n(i) = \lim_{N \rightarrow \infty} W^{n,N}(i);$$

that is the minimum cost is the limit of the minimum costs associated with the finite horizon Markovian stopping times. Moreover, the Bellman optimality equation holds:

$$W^n(i) = \min\{C(n, i, s), C(n, i, c) + \sum_{j \in \mathcal{S}} K_{ij}(c, n)W^{n+1}(j)\}. \quad (8.13)$$

**Proof:** Clearly,  $W^{n,N}(i)$  is a decreasing sequence as  $N$  increases since the policies in  $\mathcal{T}^{n,N}$  are in  $\mathcal{T}^{n,N+1}$  so the limit

$$W^n(i) := \lim_{N \rightarrow \infty} W^{n,N}(i)$$

exists. Obviously

$$C(n, i, s) \geq W^{n,N}(i) \geq V^n(\vec{x}_{n-1}, \vec{a}_{n-1}, i).$$

We therefore have

$$W^n(i) \geq V^n(\vec{x}_{n-1}, \vec{a}_{n-1}, i).$$

Moreover, since  $W^{n,N}(i)$  is the optimal cost for the finite horizon problem, it satisfies the Bellman optimality equation

$$\begin{aligned} W^{n,N}(i) &= \min\{C(n, i, s), C(n, i, c) + \sum_{j \in \mathcal{S}} K_{ij}(c, n)W^{n+1,N}(j)\} \\ W^{N,N}(i) &= C(N, i, s). \end{aligned} \quad (8.14)$$

It follows by the Monotone Convergence Theorem that by letting  $N \rightarrow \infty$  in (8.14) we get

$$W^n(i) = \min\{C(n, i, s), C(n, i, c) + \sum_{j \in \mathcal{S}} K_{ij}(n)W^{n+1}(j)\}.$$

The main thing left to show now is that  $W^n(i) \leq V^n(\vec{x}_{n-1}, \vec{a}_{n-1}, i)$  since the reverse inequality is automatic as remarked above. If  $V^n(\vec{x}_{n-1}, \vec{a}_{n-1}, i) > -\infty$  then by definition there exists a stopping time  $\tau$  in  $\mathcal{T}^{n,N}$  such that

$$E \left[ \sum_{t=n}^{\tau-1} C(t, X_t, c) + C(\tau, X_\tau, s) \mid \vec{X}_{n-1}, X_n = i \right] \leq V^n(\vec{x}_{n-1}, \vec{a}_{n-1}, i) + \epsilon.$$

However the optimal policy for minimizing the left hand side above is Markovian so  $W^n(i) \leq V^n(\vec{x}_{n-1}, \vec{a}_{n-1}, i) + \epsilon$  and the result follows.

If  $V^n(\vec{x}_{n-1}, \vec{a}_{n-1}, i) = -\infty$  then by definition there exists a stopping time  $\tau$  in  $\mathcal{T}^{n,N}$  such that

$$E \left[ \sum_{t=n}^{\tau-1} C(t, X_t, c) + C(\tau, X_\tau, s) \mid \vec{X}_{n-1}, X_n = i \right] \leq -L$$

where  $L$  is arbitrarily large. However the optimal policy for minimizing the left hand side above is Markovian so  $W^n(i) \leq -L$  for all  $L$ . It follows that  $W^n(i) = -\infty = V^n(\vec{x}_{n-1}, \vec{a}_{n-1}, i)$ . ■

**Example 8.20 Pathological Cases - (8.18) continued**

Suppose there is only action  $c$  at time  $t = 0$  and suppose  $K_{0,n}(c, 0) = (10^6 n(n+1))^{-1}$  for  $n = 1, 2, \dots$  and  $K_{0,0}(c, 0) = 1 - 10^{-6}$ . Moreover suppose  $N = 1$ ,  $C(0, 0, s) = -10^8$ ,  $C(0, 0, c) = 0$ ,  $C(1, n, s) = -n$  for  $n = 0, 1, 2, \dots$ . In this case we can play and in fact the optimal strategy is to do so because  $W^0(0) = -\infty$ . This is a bit crazy because we forgo one hundred million and have too a high probability of getting nothing in return. In real life we would take the one hundred million because we would never trust a game that promises a gain (negative cost) of infinity. This shows the limitations of measuring optimality only in terms of expectation.

We now turn to the optimal strategy. Let  $\mu^{n,N}(i) \in \mathcal{T}^{n,N}$  be the optimal Markovian stopping time starting in state  $i$  at time  $n$  if the horizon is  $N$ . Naturally,

$$\mu^{n,N}(i) = \min\{m : n \leq m \leq N, W^{m,N}(X_m) \geq C(m, X_m, s)\}.$$

Define the policy

$$\mu^n(i) = \min\{m : n \leq m, W^m(X_m) \geq C(m, X_m, s)\}.$$

For  $N > m$ ,  $W^{k,N}(i) \downarrow W^k(i)$  for all  $k \leq m$  so necessarily  $\mu^n(i) \geq \mu^{n,N}(i)$ . To be more precise

**Proposition 8.21**  $\mu^{n,N}(i) \uparrow \mu^n(i)$ .

**Proof:** On the set  $\{\mu^n(i) = m\}$ ,  $W^k(X_k) < C(k, X_k, s)$  for  $k = 0, 1, \dots, m-1$  and  $W^m(X_m) \geq C(m, X_m, s)$ . Consequently, for all  $N$  sufficiently large,  $W^{k,N}(X_k) < C(k, X_k, s)$  for  $k = 0, 1, \dots, m-1$  and  $W^{m,N}(X_m) \geq C(m, X_m, s)$  on the set  $\{\mu^n(i) = m\}$ . Consequently for  $N$  sufficiently large  $\mu^{n,N}(i) = m$  on the set  $\{\mu^n(i) = m\}$ . Similarly for  $N$  sufficiently large  $\mu^{n,N}(i) > m$  on the set  $\{\mu^n(i) > m\}$ . ■

The policy  $\mu^n$  is only useful if it is almost surely finite.

**Theorem 8.22** *If, starting from any state  $i$  at any time  $t$ ,  $C(t, i, s)^- \geq \underline{L}_0$  and*

$$C(N, X_N, s)^+, N = t, t+1, \dots \text{ are uniformly integrable} \tag{8.15}$$

*(or we could just assume  $\underline{L}_0 \leq C(t, i, s) \leq \bar{L}_0$  for all  $t$  and  $i$ ) and if*

$$E \left( \inf_N \sum_{t=0}^N C(t, X_t, c) | X_0 = i \right)^- < \infty \text{ for all } i, \tag{8.16}$$

and for all  $B$

$$\lim_{N \rightarrow \infty} P\left(\sum_{t=0}^N C(t, X_t, c) < B\right) = 0 \text{ for any starting state,} \quad (8.17)$$

then  $P(\mu^n = \infty) = 0$ . Moreover  $W^n(i)$  is the expected cost associated with  $\mu^n$  and  $W^n(i)$  is the unique solution to the Bellman optimality equation (8.13) which is uniformly bounded below in  $n$  and  $i \in S$ .

**Proof:**

First,

$$\begin{aligned} W^{n,N}(i) &= E \left[ \chi\{\mu^{n,N} = N\} \sum_{t=n}^{N-1} C(t, X_t, c) \right] \\ &+ E \left[ \chi\{\mu^{n,N} < N\} \sum_{t=n}^{\mu^{n,N}-1} C(t, X_t, c) + C(\mu^{n,N}, X_{\mu^{n,N}}, s) \right] \\ &\geq E \left[ \chi\{\mu^{n,N} = N\} \sum_{t=n}^{N-1} C(t, X_t, c) \right] + E \left[ \chi\{\mu^{n,N} < N\} \inf_M \sum_{t=n}^M C(t, X_t, c) \right] + \underline{L}_0 \\ &\geq E \left[ \chi\{\mu^{n,N} = N\} \sum_{t=n}^{N-1} C(t, X_t, c) \right] - E(\inf_M \sum_{t=n}^M C(t, X_t, c))^- + \underline{L}_0. \end{aligned}$$

Therefore, taking the limit inferior as  $N \rightarrow \infty$  and using (8.16),

$$W^n(i) \geq \liminf_{N \rightarrow \infty} E \left[ \chi\{\mu^{n,N} = N\} \sum_{t=n}^{N-1} C(t, X_t, c) \right] + \underline{L}_1 + \underline{L}_0 \quad (8.18)$$

Let  $S_{n,N} = \sum_{t=n}^N C(t, X_t, c)$  so for any large  $B$

$$\begin{aligned} &E \left[ \chi\{\mu^{n,N} = N\} \sum_{t=n}^{N-1} C(t, X_t, c) \right] \\ &\geq BP(\chi\{\mu^{n,N} = N\} \cap \{S_{n,N-1} > B\}) + E(\chi\{\mu^{n,N} = N\} \cap \{S_{n,N-1} \leq B\} S_{n,N-1}) \\ &\geq B(P(\mu^{n,N} = N) - P(\{\mu^{n,N} = N\} \cap \{S_{n,N-1} \leq B\})) \\ &+ E(\chi\{\mu^{n,N} = N\} \cap \{S_{n,N-1} \leq B\} \inf_M S_{n,M}). \end{aligned} \quad (8.19)$$

Next,

$$\begin{aligned} &E(\chi\{\mu^{n,N} = N\} \cap \{S_{n,N-1} \leq B\} \inf_M S_{n,M}) \\ &\leq -E(\chi\{S_{n,N-1} \leq B\} (\inf_M S_{n,M})^-). \end{aligned}$$

Since  $S_{n,M} = S_{0,M} - S_{0,n-1}$  we see

$$\left(\inf_M S_{n,M}\right)^- \leq \left(\inf_M S_{0,M}\right)^- + \left(\sum_{t=0}^{n-1} C(t, X_t, c)^+\right)$$

and both the terms on the right have an expectation less than infinity by hypothesis. Consequently  $E(\inf_M S_{n,M})^- < \infty$ . Using Condition (8.17),  $P(S_{n,N-1} \leq B) \rightarrow 0$  as  $N \rightarrow \infty$ . Hence, using Lemma 9.4,

$$\lim_{N \rightarrow \infty} E(\chi\{\mu^{n,N} = N\} \cap \{S_{n,N-1} \leq B\} \inf_M S_{n,M}) = 0.$$

Therefore, by (8.19),

$$\liminf_{N \rightarrow \infty} E \left[ \chi\{\mu^{n,N} = N\} \sum_{t=n}^{N-1} C(t, X_t, c) \right] \geq B \liminf_{N \rightarrow \infty} P(\mu^{n,N} = N) = BP(\mu^n = \infty).$$

Now as  $B \rightarrow \infty$  the term  $BP(\mu^n = \infty)$  tends to infinity if  $P(\mu^n = \infty) > 0$  and this implies  $W^{n,N}(i) = \infty$ . We know this is false since  $W^{n,N}(i) \leq C(n, i, s)$  so we conclude  $P(\mu^n = \infty) = 0$ .

Next, let  $V^n(i)$  be another finite solution to the Bellman optimality equation (8.13) which is bounded below by  $\underline{L}_2$  uniformly in  $n$  and  $i \in S$ . Define the policy

$$\theta^n(i) = \min\{m : n \leq m, V^m(X_m) \geq C(m, X_m, s)\}.$$

Using backwards induction from a time horizon  $N$  we see  $V^n(i)$  is the cost associated with this stopping time if the cost of stopping in state  $j$  at the horizon time  $N$  is  $V^N(j)$ . That is,

$$\begin{aligned} V^n(i) &= E \left[ \sum_{t=n}^{\theta^n \vee N-1} C(t, X_t, c) \right] + E[\chi\{\theta^n < N\}C(\theta^n, X_{\theta^n}, s)] \\ &\quad + E[\chi\{\theta^n \geq N\}V^N(X_N)]. \end{aligned} \tag{8.20}$$

Because of (8.13),  $V^N(j) \leq C(N, j, s)$  so necessarily  $V^n(i) \leq W^{n,N}(i)$ . Since  $N$  is arbitrary, we conclude  $V^n(i) \leq W^n(i)$ . Now we need to prove the reverse inequality.

If we now repeat the above argument and use the hypothesis that  $V^N(X_N) \geq \underline{L}_2$  we conclude  $P(\theta^n = \infty) = 0$ . Therefore,  $P(\theta^n \geq N) \rightarrow 0$ . We want to replace  $V^N(X_N)$  by  $C(N, X_N, s)$  in (8.20). We know  $V^N(X_N) \leq C(N, X_N, s)$  therefore the difference between the two is less than the maximum possible value of  $C(N, X_N, s)$  minus the minimum possible value of  $V^N(X_N)$ ; that is  $C(N, X_N, s)^+ - \underline{L}_2$ . However, by hypothesis 8.15, the sequence  $X_N = C(N, X_N, s)^+ - \underline{L}_2$  indexed by  $N$  is uniformly integrable. Hence, again using Lemma 9.4,

$$d_N = E[\chi\{\theta^n \geq N\}(C(N, X_N, s) - V^N(X_N))] \rightarrow 0 \text{ as } N \rightarrow \infty.$$

Replacing  $V^N(X_N)$  by  $C(N, X_N, s)$  in (8.20) we get

$$V^n(i) \geq E \left[ \sum_{t=n}^{\theta^n \vee N-1} C(t, X_t, c) \right] + E [\chi\{\theta^n < N\}C(\theta^n, X_{\theta^n}, s)] \\ + E [\chi\{\theta^n \geq N\}C(N, X_N, s)] - d_N$$

Next  $W^{n,N}(i)$  is the optimal optimal cost for the finite horizon optimal stopping problem with a cost of stopping in state  $j$  at the horizon equal to  $C(N, j, s)$ . Hence,  $V^n(i) \geq W^{n,N}(i) - d_N$  so letting  $N \rightarrow \infty$  we get  $V^n(i) \geq W^n(i)$ . This proves the reverse inequality.

Finally, let  $V^n(i)$  be the expected cost associated with the policy  $\mu^n$ . Note that

$$V^n(i) = E \left[ \sum_{t=n}^{\mu^n(i)-1} C(t, X_t, c) + C(\tau, X_{\mu^n(i)}, s) | X_n = i \right] \\ \geq E \left[ \inf_M \sum_{t=n}^M C(t, X_t, c) | X_n = i \right] + \underline{L}_0 > -\infty$$

uniformly in  $n$  and  $i \in S$  because of (8.16). Clearly  $V^n(i)$  satisfies the Bellman optimality equation so by uniqueness we have  $V^n(i) = W^n(i)$  so the policy  $\mu^n$  does indeed yield the minimal expected cost. ■

**Corollary 8.23** *In addition to the hypotheses of Theorem 8.22 we assume the costs are time homogeneous so  $C(t, i, c) = C(i, c)$  and  $C(t, i, s) = C(i, s)$  and also that the transition kernel is time homogeneous so  $K_{ij} = K_{ij}(c) = K_{ij}(c, n)$ . Then there exists an optimal Markovian stopping time  $\mu$ . It follows that  $W(i) \equiv W_\mu(i) = W^n(i)$  and  $W(i)$  satisfies*

$$W(i) = \min\{C(i, s), C(i, c) + \sum_{j \in S} K_{ij}W(j)\}$$

and it is optimal to stop at state  $i$  if  $W(i) = C(i, s)$ .

Moreover, if we define the transformation  $R$  of a bounded function  $u$  on  $S$  by

$$Ru(i) := \min\{C(i, s), C(i, c) + \sum_{j \in S} K_{ij}u(j)\}$$

then if  $u_0(i) = C(i, s)$ ,  $R^N u_0(i) = W^{0,N}(i) \rightarrow W^0(i) = W(i)$  as  $N \rightarrow \infty$ . Finally  $W(i)$  is the unique fixed point of  $R$  which is uniformly bounded below in  $i$ .

**Proof:** If future costs are independent of time, then the Markovian nature of the optimal solution means that  $W^n(i)$  is time independent and therefore equal to  $W(i)$ . It is easy to check that  $R^N u_0(i)$  satisfies Bellman's optimality equation for the stopping problem with horizon  $N$  and consequently, is the minimal cost and therefore equals  $W^{0,N}(i)$ . The transformation  $R$  is equivalent to backward induction by one step! ■

Consider a positive recurrent, aperiodic Markov chain  $X_n$  with a stationary probability distribution  $\pi$ . Further, suppose the conditional distribution  $K_{xy} = P(X_1 = y|X_0 = x)$  is stochastically increasing in  $x$ . This just means that for any  $t$ ,  $P(X_1 > t|X_0 = x)$  is an increasing function of  $x$ . Now let  $\phi$  be a positive, nondecreasing function on  $(-\infty, \infty)$  and let us consider the optimal stopping rule  $\tau$  which minimizes

$$E_x \sum_{t=0}^{\tau-1} (\phi(X_t) - \lambda).$$

In this case the terminal cost is  $C(x, s) = 0$  and  $C(x, c) = \phi(x) - \lambda$ . Clearly if  $\lambda = 0$  then  $\tau = 0$  since in this case the minimum is 0. We suppose, henceforth, that  $\lambda > 0$  and we proceed by checking the conditions of Corollary 8.23.

We may apply Theorem 5.18 (even if  $E_\pi \phi(X_0) = +\infty$ ):

$$\lim_{n \rightarrow \infty} S_n = E_\pi (\phi(X_0) - \lambda) \text{ with probability one where } S_n = \frac{1}{n} \sum_{t=0}^n (\phi(X_t) - \lambda).$$

Therefore, if we pick  $\lambda < \bar{\lambda} := E_\pi \phi(X_0)$  we can be sure  $\lim_{n \rightarrow \infty} S_n = \infty$  with probability one. Consequently, we can check both conditions in Corollary 8.22.

In particular, to check Condition 8.16 note that because  $S_N \rightarrow \infty$ ,  $\inf_N S_N > -\infty$  with probability one. However this doesn't quite prove  $E(\inf_N S_N)^- < \infty$ . Note that  $(X_N, S_N)$  is a transient Markov chain (actually, it's called a Markov additive process) and  $\inf_N S_N$  is bounded below by  $-\lambda$  times the number of visits by  $(X_N, S_N)$  to the set where  $\{x, s\} : s < 0\}$ . One can bound this expectation using Lyapounov function techniques. Alternatively, to calculate this expected value it suffices to estimate  $P(S_N < 0)$ . Calculating the probability of large deviations away from the mean is another entire subject which we can't include here (see Dembo and Zeitouni).

On the contrary, if  $\lambda \geq \bar{\lambda}$  then

$$\liminf_{n \rightarrow \infty} \sum_{t=0}^n (\phi(X_t) - \lambda) = -\infty.$$

This is obvious by the law of large numbers if  $\lambda > \bar{\lambda}$ . The more subtle case of  $\lambda = \bar{\lambda}$  follows from the law of the iterated logarithm which we will not discuss here.

We assume, henceforth, that  $\lambda < \bar{\lambda}$  so  $W(x) \equiv W(x, \lambda) > -\infty$ . Since the cost structure and transition rates are independent of time we may apply Corollary 8.23. Hence, there exists a Markovian stopping time  $\mu$  which minimizes the expected loss. Moreover, this minimum expected loss,  $W(x)$ , incurred starting from  $x$  is the limit of the policy iteration procedure  $R^N u_0(x)$  where  $u_0(x) = C(x, s) = 0$  and

$$Ru(x) := \min\{0, \phi(x) - \lambda + \sum_y K_{xy} u(y)\}.$$

Certainly  $u_0$  is nondecreasing. Suppose now  $u$  is any nondecreasing function. It is easy to see that  $Ru$  is also nondecreasing. First,  $\phi$  is nondecreasing in  $x$  by hypothesis. Also,  $E(u(X_1)|X_0 = x)$  is nondecreasing in  $x$  by Exercise 3.7 since by hypothesis the conditional distribution of  $X_1$  given  $X_0 = x$  is stochastically increasing in  $x$ . Hence the two parts of  $Ru$  are increasing. Hence, all the iterates  $R^N u_0$  are increasing in  $x$ , so  $W(x, \lambda)$  is also. In fact, if  $\phi$  is strictly increasing at some point  $x$  then we also have that

$$\phi(x) - \lambda + \sum_y K_{xy} W(y, \lambda)$$

is also strictly increasing in  $x$  at this point.

Clearly,  $W(x, \lambda) \leq 0$  since one policy is to stop immediately and this yields a cost of 0. If  $W$  is strictly negative, however, it would never be optimal to stop and we have ruled this out by picking  $\lambda < \bar{\lambda}$ . We conclude there must exist a smallest  $\ell := \ell(\lambda)$  such that  $W(\ell) = 0$  and since  $W(x)$  is increasing in  $x$  it follows that  $W(x) = 0$  for all  $x \geq \ell$ . Consequently, the optimal policy is to stop as soon as  $X_n \geq \ell$ . At this point  $\ell$

$$W(\ell) = 0 \leq \phi(\ell) - \lambda + \sum_y K_{\ell y} W(y).$$

If, moreover,  $\phi$  is strictly increasing at  $\ell$ , it follows that

$$\phi(x) - \lambda + \sum_y K_{xy} W(y) > 0$$

for  $x > \ell$ . In other words, there is no indifference region and the optimal stopping level is unique; it is optimal to stop at or above the level  $\ell$  and to continue below this level.

We may also investigate  $W(x)$  as a function of  $\lambda$  and we denote it by  $W(x, \lambda)$ . Suppose  $u(x, \lambda)$  is a function which is concave and decreasing in  $\lambda$  for each fixed  $x$ . Consider the new function  $Ru$ . By inspection this function is also concave and decreasing in  $\lambda$ . Now, since for any fixed  $\lambda$  the iterates  $R^N u_0$  converge to  $W(x, \lambda)$  and since  $u_0 \equiv 0$  is both concave and decreasing (where decreasing means nonincreasing), we conclude that for any fixed  $x$ ,  $W(x, \lambda)$  is concave (and hence continuous) and decreasing in  $\lambda$ . It also follows that for any fixed  $x$ ,  $W(x, \lambda)$  is a continuous, decreasing function in  $\lambda$  which decreases to  $-\infty$  as  $\lambda \uparrow \bar{\lambda}$ .

As a function of  $\lambda$ , the function

$$\beta(x, \lambda) = \phi(x) - \lambda + \sum_y K_{xy} W(y, \lambda)$$

is convex and  $\beta(x, 0) = \phi(x)$ . Since  $W(y, \lambda) \rightarrow -\infty$  as  $\lambda \uparrow \bar{\lambda}$  so does  $\beta(x, \lambda)$ . For any  $L$  we can therefore solve the equation  $\beta(L, \lambda(L)) = 0$  with  $0 < \lambda(L) < \bar{\lambda}$ . Next,



by the Bellman optimality equation

$$W(x, \lambda(L)) = \left( \phi(x) - \lambda(L) + \sum_y K_{xy} W(y, \lambda(L)) \right)^-.$$

Moreover it is optimal to stop when  $W(x, \lambda(L)) = 0$ . Since  $W(x, \lambda(L))$  is increasing in  $x$  this will be the case when  $x \geq \ell$  for some  $\ell$ .

Clearly  $\ell \leq L$  because  $W(L, \lambda(L)) = 0$ . But  $\ell$  can't be strictly less than  $L$  because then

$$\phi(\ell) - \lambda(L) + \sum_y K_{\ell y} W(y, \lambda(L)) \geq 0$$

or

$$\phi(L) + \sum_y K_{Ly} W(y, \lambda(L)) \leq \phi(\ell) + \sum_y K_{\ell y} W(y, \lambda(L)).$$

This can't be because  $\phi(x) + \sum_y K_{xy} W(y, \lambda(L))$  is an increasing function of  $x$  which is strictly increasing at  $L$  if  $\phi(x)$  is strictly increasing at  $L$ .

We summarize the above results:

**Proposition 8.24** *For any  $L$  we can pick  $\lambda(L) < \bar{\lambda}$  so that  $W(x, \lambda(L)) = 0$  for  $x \geq L$  and  $W(x, \lambda(L)) < 0$  for  $x < L$ .*

**Theorem 8.25** *Let  $X_n$  be a positive recurrent, aperiodic Markov chain such that the conditional distribution in  $y$  of  $K_{xy} = P(X_1 = y | X_0 = x)$  is stochastically increasing in  $x$ . Let  $\phi$  be a positive, nondecreasing function which is strictly increasing at some level  $L$ . Suppose that  $E_0 \tau_L = \gamma$ , then among all stopping times  $\tau$  such that  $E_0 \tau \geq \gamma$ , the stopping time  $\tau_L$  is the one that minimizes*

$$E_0 \sum_{t=0}^{\tau-1} \phi(X_t).$$

**Proof:** Consider the unconstrained optimal stopping problem of minimizing the sum

$$E_0 \sum_{t=0}^{\tau-1} (\phi(X_t) - \lambda(L)) = E_0 \sum_{t=0}^{\tau-1} \phi(X_t) - E_0 \tau \cdot \lambda(L)$$

over stopping times  $\tau$ . By the above theory, the optimal time is precisely  $\tau_L$ .

Consequently, for any stopping time  $\tau$  such that  $E_0\tau \geq \gamma$  we have

$$\begin{aligned} E_0 \sum_{t=0}^{\tau_L-1} \phi(X_t) - \gamma\lambda(L) &= E_0 \sum_{t=0}^{\tau_L-1} \phi(X_t) - E_0\tau_L \cdot \lambda(L) \\ &= E_0 \sum_{t=0}^{\tau_L-1} (\phi(X_t) - \lambda(L)) \\ &\leq E_0 \sum_{t=0}^{\tau-1} (\phi(X_t) - \lambda(L)) \text{ since } \tau_L \text{ minimizes the above,} \\ &= E_0 \sum_{t=0}^{\tau-1} \phi(X_t) - E_0\tau \cdot \lambda(L) \leq E_0 \sum_{t=0}^{\tau-1} \phi(X_t) - \gamma \cdot \lambda(L) \end{aligned}$$

since  $E_0\tau \geq \gamma$ . Comparing the first and last members of this string of inequalities shows that for any stopping time  $\tau$  such that  $E_0\tau \geq \gamma$ ,

$$E_0 \sum_{t=0}^{\tau_L-1} \phi(X_t) \leq E_0 \sum_{t=0}^{\tau-1} \phi(X_t);$$

that is  $\tau_L$  solves the constrained optimization problem! ■

## 8.6 Quality Control - a Worst Case Analysis

A practicing quality control engineer usually desires to minimize the average off-target run length subject to the constraint that the average on-target run length is greater than some acceptable minimum. The Cusum procedure was invented by Page in 1954 and engineers have assumed since the sixties that this procedure should do very well in detecting a sudden change in mean. It was a pleasant surprise that the Cusum was finally shown to be *optimal* in 1986 (see Moustakides (1986)).

The Cusum is optimal but only in a worst case sense which must be made precise. We shall assume the quality variables  $V_1, V_2, \dots$  are measured sequentially one at a time. Until the change point at time  $m$ , the quality variables  $V_1, \dots, V_{m-1}$  have p.m.f.  $f_0$ , while after the change point the quality variables  $V_m, V_{m+1}, \dots$  have p.m.f.  $f_1$ . These distributions are assumed known. For instance, the on-target distribution  $f_0$  might be normal with mean  $\mu$  and standard deviation  $\sigma$ , while the off-target distribution  $f_1$  might also be normal with mean  $\mu + \delta\sigma$  and standard deviation  $\sigma$ .

Denote the joint distribution of the above change point variables by  $P_m$  and let  $E_m$  denote the associated expectation. If there is no change point, all the variables have p.m.f.  $f_0$  and we denote the product probability and associated expectation by  $P_\infty$  and  $E_\infty$ . Let  $\mathcal{F}_n$  denote the  $\sigma$ -algebra generated by the observations  $V_1, \dots, V_n$ . A stopping time  $\tau$  relative to the family of  $\sigma$ -algebras  $\mathcal{F}_n$  is such that  $\tau = n$  can be determined by  $\vec{V}_n = (V_1, V_2, \dots, V_n)$ . For such a stopping time we can define the

worst case off-target run length given the past before the change point at time  $m$  as follows:

$$D_m(\tau) = \sup_{\vec{v}_{m-1}} E_m \left( \max\{\tau - m + 1, 0\} \mid \vec{V}_{m-1} = \vec{v}_{m-1} \right). \tag{8.21}$$

Since the change point can occur at any point in time  $m$  we again consider the worst case and define

$$D(\tau) = \sup_{m \geq 1} D_m(\tau). \tag{8.22}$$

Page’s procedure is optimal in the sense that it has the best worst case behavior! This obviously appeals to the most pessimistic engineers.

**Theorem 8.26** *Page’s procedure, which is often called the Cusum, minimizes  $D(\tau)$  among all stopping times  $\tau$  whose on-target run length,  $E_\infty \tau$ , is greater than  $\gamma$ .*

The first task is to state exactly what we mean by Page’s procedure. First define the likelihood ratio  $\ell(x) = f_1(x)/f_0(x)$  and then, by recursion, define

$$L_0 = 0, L_n = \max\{L_{n-1}, 1\} \ell(V_n) \text{ for } n \geq 1.$$

Page’s stopping time is defined to be

$$\tau^P := \min\{n \geq 1 : L_n \geq \exp(h)\}.$$

We will assume  $h > 0$  although in general it could be negative.

This doesn’t look much like the Cusum we have discussed in previous chapters. To make the connection we first define  $T_n := \max\{L_n, 1\}$ . Note that  $T_n = \max\{T_{n-1} \ell(V_n), 1\}$ . Note that if  $h > 0$ , Page’s stopping time is precisely the first time  $T_n$  crosses the level  $\exp(h)$  since  $T_n = L_n$  if  $L_n > 1$ . Now define  $C_n = \log(T_n)$  and let  $Y_n = \log(\ell(V_n))$ . It follows that

$$C_0 = 0, C_n = \max\{C_{n-1} + Y_n, 0\}.$$

In other words, Page’s stopping time is  $\min\{n \geq 1 : C_n \geq h\}$  and this is closer to the definition of the Cusum we have seen before.

To complete the connection let us try a special case. Suppose  $f_0$  is a discrete normal p.m.f. with mean  $\mu_0$  and variance  $\sigma^2$ . This just means the continuous normal density is discretized and taken as a p.m.f. at some small scale. Suppose  $f_1$  is a discrete normal p.m.f. with mean  $\mu_1 > \mu_0$  and variance  $\sigma^2$ .

$$\begin{aligned} \log(\ell(x)) &= \log \left( \left( \frac{1}{\sqrt{2\pi\sigma}} \exp\left(-\frac{(x - \mu_1)^2}{2\sigma^2}\right) \right) \left( \frac{1}{\sqrt{2\pi\sigma}} \exp\left(-\frac{(x - \mu_0)^2}{2\sigma^2}\right) \right)^{-1} \right) \\ &= \frac{-1}{2\sigma^2} (-2(\mu_1 - \mu_0)(x - \mu_0) + (\mu_1 - \mu_0)^2) \\ &= \frac{(\mu_1 - \mu_0)}{\sigma^2} \left( x - \frac{\mu_0 + \mu_1}{2} \right). \end{aligned}$$

This means that, up to a constant factor,

$$Y_n = V_n - \frac{\mu_0 + \mu_1}{2}.$$

Taking  $k = (\mu_0 + \mu_1)/2$  as the anchor value we see the Cusum is defined by

$$C_0 = 0, C_n = \max\{C_{n-1} + V_n - k, 0\}$$

and Page's stopping time is defined as the first time  $C_n \geq H$  where

$$H = \frac{(\mu_1 - \mu_0)}{\sigma^2} h.$$

The level  $H$  is now determined by the average on-target run length as was discussed in Chapter 5. Besides the fact that the Cusum is optimal, we now see that when detecting a change in mean of a normal distribution, the optimal anchor value is exactly half-way between the on and off-target means!

We now work our way up to a proof of Theorem 8.26. First we need some technical lemmas.

**Lemma 8.27** *For any  $n > m \geq 1$  and for fixed  $\{V_{m+1}, \dots, V_n\}$ , the quantity  $L_n$  is a nondecreasing function of  $T_m$ . Also,  $T_n$  can be written as*

$$T_n = \sum_{j=1}^{n+1} [1 - L_{j-1}]^+ \prod_{k=j}^n \ell(V_k), \tag{8.23}$$

where we define  $\prod_{k+1}^k \cdot = 1$  and  $[x]^+ \equiv \max\{0, x\}$ .

**Proof:** Both the above statements are proved by induction. First remark that by definition  $L_n = \max\{L_{n-1}, 1\} \ell(V_n) = T_{n-1} \ell(V_n)$  so  $L_n$  is a nondecreasing function of  $T_{n-1}$ . Next, again by definition,

$$L_n = \max\{L_{n-1}, 1\} \ell(V_n) = \max\{T_{n-2} \ell(V_{n-1}), 1\} \ell(V_n).$$

Again, for fixed values of  $V_{n-1}, V_n$ , we see  $L_n$  is a nondecreasing function of  $T_{n-2}$  since the function  $\max\{\cdot, 1\}$  is nondecreasing. Iterating in this way we see why  $L_n$  is a nondecreasing function of  $T_m$  and we can see how to prove it using induction.

The second statement follows in a similar way:

$$\begin{aligned} T_n &= \max\{L_n, 1\} = L_n + [1 - L_n]^+ = \max\{L_{n-1}, 1\} \ell(V_n) + [1 - L_n]^+ \\ &= (L_{n-1} + [1 - L_{n-1}]^+) \ell(V_n) + [1 - L_n]^+ \\ &\dots = \sum_{j=1}^{n+1} [1 - L_{j-1}]^+ \prod_{k=j}^n \ell(V_k) \end{aligned}$$

by iteration. ■

In the event  $\tau^P \geq m$ , the above lemma shows  $L_n$  is a nondecreasing function of  $T_{m-1}$  for  $n = m, m + 1, \dots$  given a fixed sequence  $V_m, V_{m+1}, \dots$ . This means that to maximize the time until Page's stopping time exceeds the level  $\exp(h)$  we

should have  $T_{m-1} = 1$ ; that is  $C_{m-1} = 0$ . This makes sense since, in this case, the random walk  $C_n$  has to climb the maximum distance  $h$ . This means, moreover, that  $D_m(\tau^P) = E_0(\tau^P)$  for any  $m$  since the worst place the Cusum  $L_{m-1}$  can be if the disruption occurs at time  $m$  is less than 1 ( $T_{m-1} = 1$  and  $C_{m-1} = 0$ ).

**Lemma 8.28** For any stopping time  $\tau$

$$E_\infty \sum_{k=0}^{\tau-1} \max\{L_k, 1\} = E_\infty \sum_{m=1}^{\infty} ([1 - L_{m-1}]^+ \chi\{\tau \geq m\} B_m(\tau)) \quad (8.24)$$

where  $B_m(\tau) := E_m([\tau - m + 1]^+ | \mathcal{F}_{m-1})$ .

**Proof:** An event  $E$  in  $\mathcal{F}_{k-1}$  may be represented by a function  $e(V_1, \dots, V_{k-1})$ . Consequently, for  $k > m$

$$\begin{aligned} E_m \chi\{E\} &= \sum_{v_1, \dots, v_{m-1}; v_m, \dots, v_{k-1}} e(v_1, \dots, v_{k-1}) \prod_{i=1}^{m-1} f_0(v_i) \prod_{j=m}^{k-1} f_1(v_j) \\ &= \sum_{v_1, \dots, v_{m-1}; v_m, \dots, v_{k-1}} e(v_1, \dots, v_{k-1}) \prod_{j=m}^{k-1} \ell(v_j) \prod_{i=1}^{k-1} f_0(v_i) \\ &= E_\infty \left( \prod_{j=m}^{k-1} \ell(V_j) \chi\{E\} \right). \end{aligned}$$

For any stopping time  $\tau$ , the event  $\{\tau \geq k\}$  is in  $\mathcal{F}_{k-1}$  so using the above we have

$$\begin{aligned} B_m(\tau) &= E_m([\tau - m + 1]^+ | \mathcal{F}_{m-1}) \\ &= \sum_{k=m}^{\infty} E_m(\chi\{\tau \geq k\} | \mathcal{F}_{m-1}) \\ &= \sum_{k=m}^{\infty} E_\infty \left( \prod_{j=m}^{k-1} \ell(V_j) \chi\{\tau \geq k\} | \mathcal{F}_{m-1} \right) \\ &= E_\infty \left( \sum_{k=m}^{\tau} \prod_{j=m}^{k-1} \ell(V_j) | \mathcal{F}_{m-1} \right). \end{aligned}$$

Hence, for any stopping time  $\tau$ ,

$$\begin{aligned}
 & E_\infty \sum_{m=1}^{\infty} ([1 - L_{m-1}]^+ \chi\{\tau \geq m\} B_m(\tau)) \\
 &= E_\infty \sum_{m=1}^{\infty} \left( [1 - L_{m-1}]^+ \chi\{\tau \geq m\} E_\infty \left( \sum_{k=m}^{\tau} \prod_{j=m}^{k-1} \ell(V_j) | \mathcal{F}_{m-1} \right) \right) \\
 &= E_\infty \sum_{m=1}^{\infty} \left( E_\infty \left( [1 - L_{m-1}]^+ \chi\{\tau \geq m\} \sum_{k=m}^{\tau} \prod_{j=m}^{k-1} \ell(V_j) | \mathcal{F}_{m-1} \right) \right) \\
 &= E_\infty \sum_{m=1}^{\infty} [1 - L_{m-1}]^+ \chi\{\tau \geq m\} \sum_{k=m}^{\tau} \prod_{j=m}^{k-1} \ell(V_j) \\
 &= E_\infty \sum_{m=1}^{\tau} \sum_{k=m}^{\tau} [1 - L_{m-1}]^+ \prod_{j=m}^{k-1} \ell(V_j) = E_\infty \sum_{k=1}^{\tau} \sum_{m=1}^k [1 - L_{m-1}]^+ \prod_{j=m}^{k-1} \ell(V_j) \\
 &= E_\infty \sum_{k=1}^{\tau} T_{k-1} \text{ by (8.23)} \\
 &= E_\infty \sum_{k=0}^{\tau-1} T_k = E_\infty \sum_{k=0}^{\tau-1} \max\{L_k, 1\}.
 \end{aligned}$$

■

**Lemma 8.29**  $\tau^P$  minimizes the following cost

$$E_\infty \left( \sum_{k=0}^{\tau-1} \max\{L_k, 1\} - \gamma \sum_{k=0}^{\tau-1} [1 - L_k]^+ \right). \quad (8.25)$$

subject to the constraint that  $E_\infty \tau \geq \gamma$  and moreover the cost associated with  $\tau^P$  is zero.

**Proof:** Recall that if  $C_n = \log(T_n)$ , it follows that  $C_0 = 0$ ,  $C_n = \max\{C_{n-1} + Y_n, 0\}$  where  $Y_n = \log(\ell(V_n))$ . Note that because the log function is strictly concave,

$$\begin{aligned}
 E_\infty \log(\ell(V_n)) &< \log(E_\infty \ell(V_n)) = \log \left( \sum_v \ell(v) f_0(v) \right) \\
 &= \log(1) = 0.
 \end{aligned}$$

Hence, the walk  $C_n$  has steps with mean less than zero so the Markov chain  $C_n = \log(T_n)$  is positive recurrent to zero. Hence, the Markov chain  $T_k$  is positive recurrent. Since the chain  $L_k$  equals  $T_k$  at least when  $L_k > 1$ , it follows that  $L_k$  is also positive recurrent since this is a class property.

The function  $\max\{\cdot, 1\}$  is increasing as is the function  $-[1 - \cdot]^+$ . Therefore, since the distribution of  $L_k = \max\{L_{k-1}, 1\} \ell(V_k)$ , given  $L_{k-1} = x$ , is clearly stochasti-

cally increasing in  $x$ , it follows by Theorem 8.25 that the stopping time  $\tau^P$  minimizes the cost in (8.25) subject to the constraint that  $E_0\tau \geq \gamma$ . Moreover, since  $B_m(\tau^P) = E_0(\tau^P)$  on the event  $\{\tau^P \geq m; L_{m-1} \leq 1\}$ , using the equality (8.24) we have

$$E_\infty \sum_{k=0}^{\tau^P-1} \max\{L_k, 1\} = \gamma E_\infty \sum_{k=0}^{\tau^P-1} [1 - L_k]^+$$

which means the cost in (8.25) has a minimum of 0 when the stopping time is  $\tau^P$ . ■

**Proof of Theorem 8.26:** Suppose  $h > 0$  is such that  $E_\infty\tau^P = \gamma$  but suppose there exists another stopping time  $\rho$  such that  $E_\infty\rho \geq \gamma$  and  $D(\rho) < D(\tau^P)$ . It follows that on the event  $L_{m-1} \leq 1$  that, for all disruption times  $m$ ,

$$B_m(\rho) \leq D_m(\rho) \leq D(\rho) < D(\tau^P) = E_0\tau^P.$$

If  $B_m(\rho) < E_0(\tau^P)$  then again by the equality (8.24) we have

$$\begin{aligned} & E_\infty \left( \sum_{k=0}^{\rho-1} \max\{L_k, 1\} - \gamma \sum_{k=0}^{\rho-1} [1 - L_k]^+ \right) \\ &= E_\infty \sum_{m=1}^{\infty} \left( [1 - L_{m-1}]^+ \chi\{\rho \geq m\} B_m(\rho) \right) - \gamma E_\infty \sum_{k=0}^{\rho-1} [1 - L_k]^+ \\ &< E_\infty \sum_{m=1}^{\infty} \left( [1 - L_{m-1}]^+ \chi\{\rho \geq m\} E_0\tau^P \right) - \gamma E_\infty \sum_{k=0}^{\rho-1} [1 - L_k]^+ \\ &= \gamma E_\infty \sum_{m=1}^{\infty} \left( [1 - L_{m-1}]^+ \chi\{\rho \geq m\} \right) - \gamma E_\infty \sum_{k=0}^{\rho-1} [1 - L_k]^+ \\ &= 0. \end{aligned}$$

We have, therefore, obtained a contradiction since by Lemma 8.29,  $\tau^P$  gives a minimum cost of zero among stopping times satisfying the constraint. ■

It's true the Page's procedure is only optimal in a worst case sense. On the other hand, the Cusum has many other advantages. It is easy to plot on a computer since it automatically rescales itself by drifting continually back to 0. It is easy to give the Cusum a headstart by starting at a value above 0 and so causing a quick reaction to a faulty initial setting of the production mechanism. Finally, the run length properties of the Cusum are relatively easy to compute as we have seen in the chapter on Markov chains. It is fair to say the Cusum is slowly becoming the industry standard for all the above reasons.

## 8.7 Exercises

Exercise 8.1 Consider the transition matrices

$$K(a) = \begin{pmatrix} \frac{1}{4} & \frac{1}{2} & \frac{1}{4} \\ \frac{1}{3} & \frac{1}{6} & \frac{1}{2} \\ \frac{1}{4} & \frac{1}{4} & \frac{1}{2} \end{pmatrix}, K(b) = \begin{pmatrix} \frac{2}{3} & \frac{1}{6} & \frac{1}{6} \\ \frac{1}{3} & \frac{1}{6} & \frac{1}{2} \\ \frac{1}{4} & \frac{1}{2} & \frac{1}{4} \end{pmatrix}.$$

Each transition can be made according to  $K(a)$  or  $K(b)$ . If we visit state 0, 1 or 2 we pay 30, 5 or 20 dollars respectively.

- What is the policy for minimizing the expected discounted costs if the discount rate is  $\alpha = 0.1$ ?
- What is this cost?

Exercise 8.2 For the decision problem in Exercise 8.1 what is the policy for minimizing the long run average costs and what is this average cost?

Exercise 8.3 Consider the transition matrix

$$K = \begin{pmatrix} 1 & 0 & 0 & 0 \\ \frac{1}{3} & 0 & \frac{1}{3} & \frac{1}{3} \\ \frac{1}{4} & \frac{1}{4} & 0 & \frac{1}{2} \\ \frac{1}{5} & \frac{2}{5} & \frac{2}{5} & 0 \end{pmatrix}.$$

If we stop in state 0, 1, 2 or 3 we pay 20, 5, 10 or 0 dollars respectively. We start in state 1. What is the optimal stopping policy and how much is the expected cost?

Exercise 8.4 The cost of action 0 in state 0 is \$1 and in state 1 is \$2. The cost of action 1 in state 0 is \$0.5 and in state 1 is \$3. The transition kernel between states 0 and 1 is

$$K(0) = \begin{pmatrix} \frac{1}{2} & \frac{1}{2} \\ \frac{1}{2} & \frac{1}{2} \end{pmatrix} \text{ and } K(1) = \begin{pmatrix} \frac{1}{4} & \frac{3}{4} \\ \frac{3}{8} & \frac{5}{8} \end{pmatrix}.$$

- If money is discounted at a rate  $\alpha = 1/2$  per transition, find the optimal policy and the optimal expected return.
- Find the optimal policy to minimize the long run average cost. What is this average cost.

Exercise 8.5 We have to supply dinner for a long haul flight. The initial order to the meal service depends on the  $R$  number of reservations. This is a maximum of 100 since there are 100 seats. The initial order is made 20 hours before departure and each meal costs \$5 dollars to prepare. Three hours before departure there is a better estimate  $S$  of the required number of meals based on the number of customers checked in and information about impending failed connections. Past experience has shown this new estimate is uniformly distributed from  $R - 30$  to  $\min\{R + 10, 100\}$ . At this state there is a chance to add more meals to the order



but this is a rush order so additional meals cost \$12 each. Finally at departure time we know the real number of meals  $M$  required. From past experience we know  $M$  is uniformly distributed from  $S - 5$  to  $\min\{S + 5, 100\}$ . Any missing meals are made up by very expensive frozen meals which cost \$20 each when time and effort are counted in.

- a) You wish to minimize costs. Suppose the number of reservations for a flight is 80. How many meals should be prepared 20 hours before the flight?
- b) Three hours before the flight the estimate for the number of meals is 76. How many additional fast order meals should be prepared.
- c) It turns out 78 customers actually board the flight. What is the total cost of meals?

Exercise 8.6 Whenever the city purchases a new bus it must prescribe a maintenance program. At the start of each month a decision must be made whether the motor of the bus must be overhauled. The overhaul takes a day. After an overhaul the motor is like new but the overhaul costs \$5,000 payable immediately. If a bus has gone  $x$  months since an overhaul then the probability it will break down during the next month of service is  $\min\{1, .1 + 0.05x\}$ . If it does break down during service there is a bill of \$7,000 payable at the end of the month for an emergency overhaul. Assume the interest rate on money is 0.5% per month. Formulate a maintenance program to minimize the expected discounted cost of keeping the bus running.

- a) Give the appropriate state space and action space.
- b) Give the transition kernel associated with the actions.
- c) Write down the Bellman optimality equation.
- d) Give the form of the optimal policy. Explain how you would calculate this policy exactly.

Exercise 8.7 Evaluate the long run average cost of the optimal policy for governing the queueing Example 8.16 as discussed at the end of that example.

Exercise 8.8 a) A record is stored on one of two magnetic tapes. The probability it is on tape I is  $\frac{3}{5}$  while the probability it is on tape II is  $\frac{2}{5}$ . The first tape has three segments: I1, I2, I3. Given the record is on tape I, the probability of being in one of these segments is given by

$$\begin{matrix} I1 & I2 & I3 \\ \frac{1}{2} & \frac{1}{3} & \frac{1}{6} \end{matrix}$$

The second tape has three segments: II1, II2, II3. Given the record is on tape II, the probability of being in one of these segments is given by

$$\begin{matrix} II1 & II2 & II3 \\ \frac{1}{3} & \frac{1}{3} & \frac{1}{3} \end{matrix}$$

The search starts at the beginning of a segment and each segment takes an hour to search. One search procedure is to completely search the segments of one tape in order and then the other until the record is found. If you decide to use this procedure starting on tape I what is the expected time to find the record?

- b) If we wish to minimize the expected time to find the record we could formulate this as a finite horizon Markov decision problem. Let the state  $X_n$  be the vector of aposterior probabilities the the record is in segment I1, I2 through II3. Hence  $X_0 = (3/10, 1/5, \dots, 2/15)$ . Fully explain the cost structure.
- c) What is the optimal action for the first search. Prove it.
- d) If this first search fails, what is the optimal action for the second search?

**Exercise 8.9** The dollar value of a night's work by a second story man is described by a random variable  $X$  with p.m.f.  $f$ . The thief has probability  $p$  of getting caught on any given caper. If the thief is caught all his ill-gotten gains are confiscated and he is put out of business. Describe the optimal policy so that the thief can retire with the maximum expected total gain. Presumably, if the thief gets caught he will try this optimal strategy again when he gets out.

**Exercise 8.10** With probability  $p_i$  there are  $i$  orders in any given day. Right after the daily orders arrive a decision is made whether or nor to immediately fill the orders. The cost of filling the orders is \$K (no matter how many orders are stockpiled) and the order is filled by the end of the day. If it is decided not to fill the orders that day then the orders wait but you pay a cost of \$c per waiting order for each day the order is delayed. All orders must be cleared by the end of the month; i.e. every 30 days all waiting orders are filled. Write down Bellman's optimality equations for the minimal expected cost. Define any symbol used. Guess the form of the optimal policy. Can you prove it?

**Exercise 8.11** An investor starts with  $C_0$  dollars of capital. His investment strategy changes each day and at the  $n$ th day, his capital of  $C_n$  dollars is allocated as follows: he spends  $S_n$  dollars and he invests  $I_n$  dollars in the stock market. The  $I_n$  dollars invested will yield a total of  $V_n I_n$  where  $V_n$  is a random variable having p.m.f.  $f$  which is independent of the entire past. The name of the game is to maximize the expected discounted expenditures  $E \sum_{n=0}^{\infty} \alpha^n S_n$ .

- (a) Set up the Bellman optimality equation.
- (b) What is the form of the optimal policy?

**Exercise 8.12** What is the optimal policy for the investor in Exercise 8.11 who wants to maximize his long run average expenditures?

**Exercise 8.13** The book by Dubins and Savage (1965) describes a situation where it makes sense to gamble. Suppose you have 20 left and you are stranded in Las Vegas. You need 500 to buy an airplane ticket back home. If you go to the roulette table you can gamble any amount on red or black (dollars, no change). If the ball falls into a red pocket and you bet on red then you double your money. If it falls

into a black pocket then you lose your money. The wheel has pockets numbered from 1 to 36, plus 0 and 00, for a total of 38 pockets. Eighteen pockets are red and eighteen are black. This is not a fair game because the pockets 0 and 00 are neither red nor black. Nevertheless it makes sense to gamble because that is the only way we will get home. What is the optimal way to gamble if the only objective is to get \$500 for a ticket.

**Exercise 8.14** For the decision problem in Exercise 8.1 suppose that in addition to the action  $a$  or  $b$  there is the option of leaving the system and receiving a payment of \$100, \$200 or \$300 if we exit from state 0, 1 or 2 respectively. What is the optimal policy if we start in state 0.

**Exercise 8.15**

It is common practice in financial markets to sell call options to businesses wishing to reduce their uncertainty about the future. Suppose company A needs to buy 1000 shares of company B before the end of the year. It might purchase a call option to buy the 1000 shares of company B at a strike price of \$50 each at any time before the end of the year. If the stock price stays below \$50 company A will not exercise the option and the option will be worthless. Company A will just buy the 1,000 shares at a convenient time for a price below \$50 per share. If the share price rises above \$50 then company A is protected because at the end of the year it can exercise the option and pay \$50,000 for the 1,000 shares.

The question is, what should such an option cost? Suppose the share price is now \$40 and we expect the price to stay roughly the same for the next two months until the end of the year. There is however one major uncertainty. An announcement from the Fed (the US Federal Reserve) might cause the price to increase by 50% or decrease by 25% or stay the same with probabilities 0.3, 0.2 and 0.5. The announcement could come on any day without warning. What is the price of the option?

**Exercise 8.16** Suppose we are selling a car and the offers come in according to a Markov chain with transition kernel  $K$ . Hence, if we have an offer of  $i$  dollars today then the probability of an offer of  $j$  dollars tomorrow is  $K_{ij}$ . Each day the car remains unsold we spend  $M$  dollars in additional interest charges. To do this problem assume that for each  $k$ ,  $\sum_{j \geq k} K_{ij}$  is nondecreasing in  $i$  as is  $\sum_j (j - i) K_{ij}$  which means the future prospects with a good offer in hand are better than those when a poor offer is in hand. What is the Bellman optimality equation for accepting an offer if we wish to maximize the difference between the selling price and the total interest charges? What is the optimal policy?

**Exercise 8.17** Two soft drink dispensers stand side by side. One has probability  $a$  of taking your money and giving you a soft drink (and probability  $1 - a$  of giving you nothing but frustration). The other has probability  $b$  of giving you a soft drink. Long hard experience has shown that  $b > a$  but you have forgotten which machine is which. You tend to believe the one on the left is the better one and in fact you

would give this belief an a priori probability of  $p_0$ . Your objective is to maximize your long run success rate.

- a) Determine the optimality equation for the associated discounted problem.
- b) Guess the optimal policy.
- c) Guess the optimal policy to maximize the long run success rate.

**Exercise 8.18** Consider the following game. You throw a die as often as you wish and when you stop you receive in dollars the average of the throws you made. What is the optimal stopping rule? Is this a Markov decision problem? Can you solve it?

**Exercise 8.19** Suppose that under normal operating conditions a 1% of items produced are defective. Every item is inspected so this means that there is a geometric number of items with mean 100 produced until a defective is found. Design an optimal on-line procedure to detect when the proportion of defective items changes suddenly to 5%. Fix the on-target run length to be 500. What is the associated off-target run length?

**Exercise 8.20** A paper mill makes huge rolls of paper 2 meters wide. There is an electric eye focused on the output which measures the number of defects over the last meter of paper; that is over a surface of 2 square meters. Defects are caused by foreign object mixed in with the raw pulp like bark or even a plastic garbage bag that is chewed up along with the timber. These small objects cause tiny discoloured spots on the white background that are scattered randomly over the surface. Under normal operating conditions these spots should arise at the mean rate of 1 per linear meter. If, however, there is a failure in the mixing room the rate will increase to a mean rate of 3 spots per linear meter. Design a quality control scheme to stop the paper production if the the mean rate increases to 3 spots per linear meter. A false alarm is very costly so design your procedure so the average on-target run length is 500 meters; that is 5 complete rolls.

## Chapter 9

# Appendix

### 9.1 Useful Results in Analysis

We first recall some elementary notation used in the book. For any real number  $x$ ,  $x^+ = \max\{x, 0\}$  and  $x^- = \max\{-x, 0\}$  so  $x = x^+ - x^-$ . When we write  $X = X^+ - X^-$  for a random variable  $X$  we simply mean that the functions are defined for each  $\omega$ ; i.e.  $X(\omega) = X(\omega)^+ - X(\omega)^-$ . We also denote the infimum and supremum of a sequence of real numbers  $\{x_n, n \in \mathcal{N}\}$  with index set  $\mathcal{N}$  by  $\inf x_n \equiv \inf_{n \in \mathcal{N}} x_n$  and  $\sup x_n \equiv \sup_{n \in \mathcal{N}} x_n$  respectively. The supremum is the least upper bound of the set of  $x$ 's while the infimum is the greatest lower bound. If  $U$  is the supremum then  $x_n \leq U$  for all  $n$  and for any  $\epsilon$  no matter how small we can find an  $m$  such that  $x_m \geq U - \epsilon$ . Similarly, if  $L$  is the infimum then  $x_n \geq L$  for all  $n$  and for any  $\epsilon$  no matter how small we can find an  $m$  such that  $x_m \leq L + \epsilon$ .

The limit of a sequence  $\{x_n, n \in \{1, 2, \dots\}\}$  is denoted by  $\lim x_n \equiv \lim_{n \rightarrow \infty} x_n$ . If the sequence is monotonically increasing or decreasing then we can write the limit  $x$  as  $x_n \uparrow x$  or  $x_n \downarrow x$  respectively. We also denote the limit inferior and the limit superior of a sequence of real numbers  $x_n, n = 0, 1, 2, \dots$  by  $\liminf x_n$  and  $\limsup x_n$  respectively. By definition  $\limsup x_n = \lim_{N \rightarrow \infty} \sup_{n \geq N} x_n$  and  $\liminf x_n = \lim_{N \rightarrow \infty} \inf_{n \geq N} x_n$ . This means that, if  $U = \limsup x_n$  then for any  $\epsilon$ , no matter how small, we can find an  $N$  such that for  $n \geq N$ ,  $x_n \leq U + \epsilon$ . Similarly if  $L = \liminf x_n$  then for any  $\epsilon$ , no matter how small, we can find an  $N$  such that for  $n \geq N$ ,  $x_n \geq L - \epsilon$ . For a sequence of random variables  $\{X_n, n \in \mathcal{N}\}$  we can define  $\sup X_n$  or  $\limsup X_n$  sample point by sample point.

### 9.2 Integration and Expectation

The expectation of a random variable  $X$ , or equivalently the Lebesgue integral of an  $\mathcal{F}$ -measurable function  $X$  on a probability space  $\{\Omega, \mathcal{F}\}$ , was defined in Section 2.2. The method is to first define the expectation of simple random variables and then approximate more complicated ones. This extension does not require that  $P$  be a probability measure but only that  $P$  be a positive measure. We continue to

write  $EX = \int_{\Omega} X dP$  even if  $P$  is any positive measure. We will however restate each theorem in terms of sums on a countable set like the integers. In these special cases  $\Omega = S$  and  $P(\{i\}) = \nu(i)$  where  $\nu(i)$  is a sequence of positive numbers indexed by the  $S$ .

This integral is a great improvement over the Riemann integral because the integral of the limit of a sequence of functions is often the limit of the integrals. First let us restate the Monotone Convergence Theorem 2.66:

**Theorem 9.1 (Monotone Convergence)** *If  $X_n$  is a sequence of random variables such that  $X_n(\omega) \uparrow X(\omega)$  for almost all  $\omega$  and  $EX_1^- < \infty$  then  $\lim_{n \rightarrow \infty} EX_n = EX$  (in fact  $EX_n \uparrow EX$ ). Similarly, if  $X_n \downarrow X$  and  $EX_1^+ < \infty$  then  $EX_n \downarrow EX$ .*

The proof may be found in Billingsley (1979).

**Corollary 9.2** *If for each  $n$ ,  $u_n(i)$  is a sequence of positive numbers such that  $u_n(i) \uparrow u(i)$  as  $n \rightarrow \infty$ , then  $\sum_{i \in S} u_n(i)\nu(i) \uparrow \sum_{i \in S} u(i)\nu(i)$ .*

**Definition 9.3** A sequence of random variables  $X_n$  is uniformly integrable if

$$\lim_{a \rightarrow \infty} \sup_n E(|X_n| \cdot \chi\{|X_n| > a\}) = 0.$$

Note that a single, integrable random variable  $X$  is uniformly integrable; i.e. if  $E|X| < \infty$  then  $\lim_{a \rightarrow \infty} E(|X| \cdot \chi\{|X| > a\}) = 0$ . This follows from the Monotone Convergence Theorem. We will also need the following lemma

**Lemma 9.4** *Let  $A_m$  be a sequence of events such that  $P(A_m) \rightarrow 0$ . If  $X_n$  is a uniformly integrable sequence then*

$$\lim_{m \rightarrow \infty} \sup_n E(|X_n| \cdot \chi\{A_m\}) = 0.$$

**Proof:** For any  $\epsilon > 0$ , pick an  $a$  such that  $\sup_n E(|X_n| \cdot \chi\{|X_n| > a\}) < \epsilon$ . Hence

$$\begin{aligned} & \sup_n E(|X_n| \cdot \chi\{A_m\}) \\ & \leq \sup_n E(|X_n| \cdot \chi\{A_m\} \cdot \chi\{|X_n| \leq a\}) + \sup_n E(|X_n| \cdot \chi\{A_m\} \cdot \chi\{|X_n| > a\}) \\ & \leq a \sup_n P(A_m \cap \{|X_n| \leq a\}) + \sup_n E(|X_n| \cdot \chi\{|X_n| > a\}) \\ & \leq a \sup_n P(A_m) + \epsilon = aP(A_m) + \epsilon. \end{aligned}$$

Hence,  $\lim_{m \rightarrow \infty} \sup_n E(|X_n| \cdot \chi\{A_m\}) \leq \epsilon$ . Since  $\epsilon$  is arbitrarily small the result follows. ■

A consequence of the Monotone Convergence Theorem is

**Theorem 9.5 (Fatou's Lemma)** *If  $X_n$  is a sequence of random variables such that the sequence  $X_n^-$  is uniformly integrable (for instance when  $X_n(\omega) \geq -L$  for almost all  $\omega$ ) then, if  $E(\liminf X_n)$  exists,*

$$\liminf_{n \rightarrow \infty} EX_n \geq E \liminf_{n \rightarrow \infty} X_n.$$

Equivalently, if  $X_n^+$  is a uniformly integrable sequence and  $E(\limsup X_n)$  exists then

$$\limsup_{n \rightarrow \infty} EX_n \leq E \limsup_{n \rightarrow \infty} X_n.$$

**Corollary 9.6** *If for each  $n$ ,  $u_n(i)$  is a sequence of positive numbers then*

$$\liminf_{n \rightarrow \infty} \sum_{i \in S} u_n(i) \nu(i) \geq \sum_{i \in S} \liminf_{n \rightarrow \infty} u_n(i) \nu(i).$$

The following theorem and its corollary will be required throughout the text.

**Theorem 9.7 (Dominated Convergence)** *Let  $X_n$  be a sequence of random variables such that  $|X_n(\omega)| \leq Z$  where  $Z$  is an integrable random variable. If  $X_n(\omega) \rightarrow X(\omega)$  for almost all  $\omega$  then  $\lim_{n \rightarrow \infty} EX_n = EX$ .*

**Corollary 9.8** *Suppose that  $u_n(i)$  is a function on  $i \in S$  and that  $|u_n(i)| \leq b(i)$  where  $b(i)$  is a non-negative, bounding function, such that  $b := \sum_{i \in S} b(i) \nu(i) < \infty$ . Suppose, moreover, that for each  $i$ ,  $\lim_{n \rightarrow \infty} u_n(i) = u(i)$ . Then*

$$\lim_{n \rightarrow \infty} \sum_{i \in S} u_n(i) \nu(i) = \sum_{i \in S} u(i) \nu(i).$$

The Dominated Convergence Theorem has a host of other applications. Define the norm of a function  $u$  on  $S = \{0, 1, 2, \dots\}$  to be  $\|u\| = \sum_{i \in S} |u(i)|$ .

**Theorem 9.9 (Scheffé's Theorem)** *Let  $f_n$  be a sequence of probability mass functions on  $S$ ; that is  $\sum_{i \in S} f_n(i) = 1$ . Suppose  $f_n(i) \rightarrow f(i)$  as  $n \rightarrow \infty$  where  $f$  is also a p.m.f. then  $\|f_n - f\| \rightarrow 0$  as  $n \rightarrow \infty$ .*

**Proof:** Let  $\delta_n = f - f_n$  so  $\sum_i \delta_n(i) = 0$ . Let  $E_n = \{i : \delta_n(i) \geq 0\}$  so

$$\begin{aligned} \|f_n - f\| &= \sum_{i \in S} |\delta_n(i)| \\ &= \sum_{i \in E_n} \delta_n(i) - \sum_{i \in E_n^c} \delta_n(i) \\ &= 2 \sum_{i \in E_n} \delta_n(i) \text{ since } \sum_{i \in E_n} \delta_n(i) + \sum_{i \in E_n^c} \delta_n(i) = 0 \\ &= 2 \sum_{i \in S} \delta_n(i)^+. \end{aligned}$$

However,  $\delta_n^+$ , the positive part of  $\delta_n$ , is uniformly bounded by  $f$  and  $f$  is summable (or integrable with respect to counting measure on the integers), so by Lebesgue's Dominated Convergence Theorem,  $\lim \sum_i \delta_n(i)^+ \rightarrow 0$  since  $\delta_n(i)^+ \rightarrow 0$  for all  $i$ . ■

Another measure theoretic result required in the text is the Borel-Cantelli Lemma:

**Lemma 9.10** *If  $\sum_n P(A_n)$  converges then  $P(\cap_{n=1}^{\infty} \cup_{k=n}^{\infty} A_k) = 0$ .*

**Proof:** For any  $m$ ,  $\bigcap_{n=1}^{\infty} \bigcup_{k=n}^{\infty} A_k \subset \bigcup_{k=m}^{\infty} A_k$ . It follows that

$$P\left(\bigcap_{n=1}^{\infty} \bigcup_{k=n}^{\infty} A_k\right) \leq P\left(\bigcup_{k=m}^{\infty} A_k\right) \leq \sum_{k=m}^{\infty} P(A_k),$$

and the final sum tends to 0 as  $m \rightarrow \infty$  if  $\sum_n P(A_n)$  converges. ■

Intuitively this result just means that if the sum  $\sum_n P(A_n)$  is finite, the probability of those sample points which lie in an infinite number of the  $A_n$  is 0.

**Theorem 9.11 (Fubini's Theorem)** *Let  $F$  and  $G$  be increasing right continuous functions. Let  $h(x, y)$  be a measurable real valued function such that either  $h \geq 0$  or one of the double Lebesgue integrals*

$$\int_x \left( \int_y |h(x, y)| dG(y) \right) dF(x), \int_y \left( \int_x |h(x, y)| dF(x) \right) dG(y)$$

is finite. Then

$$\int_x \left( \int_y h(x, y) dG(y) \right) dF(x) = \int_y \left( \int_x h(x, y) dF(x) \right) dG(y).$$

**Corollary 9.12** *Consider a sequence of real values  $h(m, n)$  having two indices such that  $\sum_{m=1}^{\infty} (\sum_{n=1}^{\infty} |h(m, n)|) < \infty$  then*

$$\sum_{m=1}^{\infty} \sum_{n=1}^{\infty} h(m, n) = \sum_{n=1}^{\infty} \sum_{m=1}^{\infty} h(m, n).$$

**Proof:** Take  $F(x) = [x]$  and  $G(y) = [y]$ ; i.e.  $F(x)$  is the integer part of  $x$  and  $G(y)$  is the integer part of  $y$ . In this case, for  $a, b \in \{1, 2, \dots\}$ ,

$$\sum_{m=1}^{\infty} h(m, b) = \int_{x>0} h(x, b) dF(x) \text{ and } \sum_{n=1}^{\infty} h(a, n) = \int_{y>0} h(a, y) dG(y)$$

and the result follows. ■

### 9.3 Convexity

**Definition 9.13** A function  $\phi$  defined on the real line is convex if for any two points  $x$  and  $y$  and any  $0 \leq \alpha \leq 1$  we have

$$\phi((1 - \alpha)x + \alpha y) \leq (1 - \alpha)\phi(x) + \alpha\phi(y).$$

$\phi$  is called concave if the reverse inequality holds.

If  $x < y$  and we take  $s = (1 - \alpha)x + \alpha y$  then this condition is equivalent to the following relationship between the slopes of line segments from  $(x, \phi(x))$  to  $(s, \phi(s))$



and from  $(s, \phi(s))$  to  $(y, \phi(y))$ :

$$\frac{\phi(s) - \phi(x)}{s - x} \leq \frac{\phi(y) - \phi(s)}{y - s}. \quad (9.1)$$

Using the mean value theorem it is easy to check that if  $\phi$  has a derivative which is monotonically increasing then  $\phi$  is convex. Alternatively, convex functions may be characterized by the following:

**Theorem 9.14** *A function  $\phi$  is convex if and only if*

$$\phi(s) = \sup\{\ell(s) : \ell(y) \leq \phi(y) \text{ for all } y, \ell(y) \in L\}$$

where  $L$  is the class of linear functions.

**Proof:** We only show convex functions may be classified this way. Let  $x < s < y$  and define  $\alpha$  so that  $s = (1 - \alpha)x + \alpha y$ . Let

$$\beta = \sup\left\{\frac{\phi(s) - \phi(x)}{s - x} : x < s\right\}.$$

By (9.1) it follows that  $\beta \leq (\phi(y) - \phi(s))/(y - s)$ . Now, for any  $\epsilon > 0$  no matter how small, we pick a value  $h$  such that  $\phi(s) - \epsilon < h < \phi(s)$ . Now draw a line,  $\ell$ , through the point  $(s, h)$  with slope  $\beta$ . If  $\ell(x) = \phi(x)$  for some  $x < s$ , this would imply the slope of the line segment from  $(x, \phi(x))$  to  $(s, \phi(s))$  is greater than the slope from  $(x, \phi(x))$  to  $(s, h)$ . However the latter slope is  $\beta$  so this is impossible. We conclude  $\ell(x) \neq \phi(x)$  if  $x < s$ . Similarly,  $\ell(y) \neq \phi(y)$  if  $s < y$ .

We have therefore constructed  $\ell \in L$  such that  $\ell(y) \leq \phi(y)$  for all  $y$ . Moreover,  $\ell(s) \geq \phi(s) - \epsilon$  where  $\epsilon$  is arbitrarily small. The result follows. ■

**Theorem 9.15** *If  $\phi$  is convex then  $E\phi(X) \geq \phi(EX)$ .*

**Proof:** Since  $E\ell(X) = \ell(EX)$  for any linear function  $\ell$ , the result follows from the above characterization. ■

**Theorem 9.16 (The Schwarz inequality)** *Let  $\mu$  be a positive measure on a measurable space and suppose two measurable functions  $f$  and  $g$  are square integrable; i.e.  $\sum f^2(x)\mu(x) < \infty$  and  $\sum g^2(x)\mu(x) < \infty$ . Then*

$$\sum |f(x)| |g(x)| \mu(x) \leq \left(\sum f^2(x)\mu(x)\right)^{1/2} \left(\sum g^2(x)\mu(x)\right)^{1/2}.$$

**Proof:** Let  $S_f = \sum f^2(x)\mu(x)$  and  $S_g = \sum g^2(x)\mu(x)$ . Define  $F = f/\sqrt{S_f}$  and  $G = g/\sqrt{S_g}$ , so  $\sum F^2(x)\mu(x) = \sum G^2(x)\mu(x) = 1$ . By the convexity of the exponential function we have

$$\exp\left(\frac{s}{2} + \frac{t}{2}\right) \leq \frac{1}{2} \exp(s) + \frac{1}{2} \exp(t).$$

Letting  $\exp(s/2) = |F(x)|$  and  $\exp(t/2) = |G(x)|$  we get that, for all  $x$ ,

$$|F(x)G(x)| \leq \frac{1}{2}F^2(x) + \frac{1}{2}G^2(x).$$

Summing with respect to the positive measure  $\mu$  we get

$$\sum |F(x)G(x)|\mu(x) \leq \frac{1}{2} \sum F^2(x)\mu(x) + \frac{1}{2} \sum G^2(x)\mu(x) \leq 1.$$

Now multiplying this inequality on both sides by  $S_f$  and  $S_g$  we have our result. ■

## 9.4 Norms and Fixed Points

Consider a countable state space  $S$ . Functions defined on  $S$  taking real values may be thought of as vectors having a countable number of components. If  $v$  is a function defined on  $S$ , we define  $\|v\| := \sup_{i \in S} |v(i)|$ . It is easy to check that  $\|v\|$  is a length or norm of  $v$ . It suffices to verify the following conditions satisfied by any norm:

- $\|v\| \geq 0$ ,
- For any two vectors  $u, v$  and any real number  $\alpha$

$$\|u + v\| \leq \|u\| + \|v\|, \|\alpha v\| \leq |\alpha| \|v\|,$$

- $\|v\| = 0$  implies  $v \equiv 0$ .

The set  $\mathcal{B}$  of functions on  $S$  having a finite norm forms a Banach space. This simply means that the vector space is complete with the given norm; that is a Cauchy sequence of vectors  $\{v_n\}$  necessarily has a limit. We recall a sequence is Cauchy if for all  $\epsilon$  there exists an  $N$  such that for all  $n, m \geq N$ ,  $\|v_n - v_m\| < \epsilon$ . Having a limit means, of course, that there exists a function  $v$  such that  $\|v\| < \infty$  and  $\lim_{n \rightarrow \infty} \|v_n - v\| = 0$ .

Clearly a Cauchy sequence  $\{v_n\}$  has components  $\{v_n(j)\}$  which form a Cauchy sequence since  $|v_n(j) - v_m(j)| \leq \sup_{i \in S} |v_n(i) - v_m(i)| = \|v_n - v_m\|$ . Hence each component converges by the completeness of the real line. Let  $v(j)$  be the limit of the  $j^{\text{th}}$  component and  $v$  the associated vector. In general for any double sequences  $x_{in}$ , we have  $x_{jm} \leq \sup_i x_{im}$ , so  $\limsup_{m \rightarrow \infty} x_{jm} \leq \limsup_{m \rightarrow \infty} \sup_i x_{im}$ . Hence taking the supremum in  $j$  we get  $\sup_i \limsup_{m \rightarrow \infty} x_{im} \leq \limsup_{m \rightarrow \infty} \sup_i x_{im}$ . Now, apply this to the double sequence  $|v_n(i) - v_m(i)|$  where we assume  $n > N$  above:

$$\begin{aligned} \sup_i |v_n(i) - v(i)| &= \sup_i \limsup_{m \rightarrow \infty} |v_n(i) - v_m(i)| \\ &\leq \limsup_{m \rightarrow \infty} \sup_i |v_n(i) - v_m(i)| \\ &\leq \limsup_{m \rightarrow \infty} \|v_n - v_m\| \leq \epsilon. \end{aligned}$$

We conclude that if  $\{v_n\}$  is Cauchy then for an arbitrary  $\epsilon$  we can find an  $N$  such that for  $n > N$ ,  $\|v_n - v\| \leq \epsilon$ . This means  $v$  is the limit of the Cauchy sequence and hence  $\mathcal{B}$  is complete.

Define  $d(u, v) = \|u - v\|$  to be the distance between two vectors  $u$  and  $v$  in  $\mathcal{B}$ . ( $d$  is called a metric and  $\mathcal{B}$  becomes a complete metric space.) A mapping  $T$  of  $\mathcal{B}$  into itself is called a contraction if there exists a positive real number  $r < 1$  with the property that  $d(Tu, Tv) \leq r \cdot d(u, v)$  for all  $u$  and  $v$  in  $\mathcal{B}$ . Any contraction is obviously continuous.

**Lemma 9.17** *If  $T$  is a contraction defined on  $\mathcal{B}$  (or in general on a complete metric space), then  $T$  has a unique fixed point; i.e. a point  $x \in \mathcal{B}$  such that  $Tx = x$ .*

**Proof:** Let  $u_0$  be an arbitrary point in  $\mathcal{B}$ , and write

$$u_1 = Tu_0, u_2 = T^2u_0 = Tu_1 \text{ and, in general, } u_n = T^n u_0 = Tu_{n-1}.$$

If  $m < n$ , then

$$\begin{aligned} d(u_m, u_n) &= d(T^m u_0, T^n u_0) = d(T^m u_0, T^m T^{n-m} u_0) \\ &\leq r^m d(u_0, T^{n-m} u_0) = r^m d(u_0, u_{n-m}) \\ &\leq r^m [d(u_0, u_1) + d(u_1, u_2) + \cdots + d(u_{n-m-1}, u_{n-m})] \\ &\leq r^m d(u_0, u_1) [1 + 2 + \cdots + r^{n-m-1}] \\ &< r^m d(u_0, u_1) \frac{1}{1-r}. \end{aligned}$$

Since  $r < 1$ , it is clear that  $u_n$  is a Cauchy sequence and, by the completeness of  $\mathcal{B}$ , there exists a point  $u$  in  $\mathcal{B}$  such that  $u_n \rightarrow u$ . Since  $T$  is continuous

$$Tu = T(\lim_{n \rightarrow \infty} u_n) = \lim_{n \rightarrow \infty} T(u_n) = \lim_{n \rightarrow \infty} u_{n+1} = u.$$

We conclude the proof by showing  $u$  is the unique fixed point. Suppose  $v$  is also a fixed point; that is  $Tv = v$ . Then  $d(u, v) = d(Tu, Tv) \leq rd(u, v)$ . Since  $r < 1$  this means  $d(u, v) = 0$  which means  $u = v$ . ■

Recall the normed vector space formed by linear transformations  $T$  of  $\mathcal{B}$  into itself, having a norm defined by  $\|T\| := \sup\{\|Tv\| : \|v\| \leq 1\}$ . We remark that

$$\|T\| = \sup_{i \in S} \left\{ \sum_{j \in S} |T_{ij}| \right\}.$$

It immediately follows that for any vector  $u$ ,  $\|Tu\| \leq \|T\| \|u\|$ . Also, if  $\|A\| < \infty$  and  $\|B\| < \infty$  then

$$\|A \cdot Bu\| \leq \|A\| \|Bu\| \leq \|A\| \|B\| \|u\|$$

so  $\|A \cdot B\| \leq \|A\| \|B\|$ .

It is also obvious that if  $T^n$  forms a Cauchy sequence in this norm then so do the components  $T_{ij}^n$ . Hence we can define a transformation  $T$  by the limit  $T_{ij}^n \rightarrow T_{ij}$

as  $n \rightarrow \infty$  for all  $i$  and  $j$ . Next

$$\begin{aligned} \|T - T^n\| &= \sup_{i \in S} \left\{ \sum_{j \in S} |T_{ij} - T_{ij}^n| \right\} \\ &\leq \sup_{i \in S} \left\{ \limsup_{m \rightarrow \infty} \sum_{j \in S} |T_{ij}^m - T_{ij}^n| \right\} \\ &\leq \limsup_{m \rightarrow \infty} \sup_{i \in S} \left\{ \sum_{j \in S} |T_{ij}^m - T_{ij}^n| \right\} \\ &= \limsup_{m \rightarrow \infty} \|T^m - T^n\|. \end{aligned}$$

Hence, if  $T^n$  forms a Cauchy sequence with the operator norm, then for an arbitrary  $\epsilon$  we can find an  $N$  such that  $\|T^m - T^n\| \leq \epsilon$  for  $m, n > N$ . From the above we conclude that for  $n > N$ ,  $\|T - T^n\| \leq \epsilon$ . Hence  $\lim_{n \rightarrow \infty} \|T - T^n\| = 0$  so the sequence  $T^n$  has a limit  $T$ . Hence the space of transformations  $T$  with finite norm is complete and forms a Banach space.

**Lemma 9.18** *If  $A$  and  $B$  are matrices of finite norm which commute; that is  $AB = BA$  then*

$$\exp(A + B) = \exp(A) \exp(B).$$

**Proof:** Let  $S_j(A) := \sum_{k=0}^j A^k/k!$  and  $S_j(B) := \sum_{k=0}^j B^k/k!$ . Clearly, by the definition of the exponential,

$$\|S_j(A) - \exp(A)\| \rightarrow 0 \text{ and } \|S_j(B) - \exp(B)\| \rightarrow 0 \text{ as } j \rightarrow \infty.$$

By matrix multiplication,

$$S_j(A)S_j(B) - S_j(A+B) = \sum \frac{B^\ell A^k}{\ell!k!}$$

where the sum is over all integers  $\ell$  and  $k$  for which  $1 \leq \ell \leq j, 1 \leq k \leq j$ , and  $j+1 \leq \ell+k \leq 2j$ . Suppose  $\|A\|$  and  $\|B\|$  are less than  $b$ , then the norm of the above difference is bounded by

$$\begin{aligned} \sum_{j+1 \leq \ell+k \leq 2j} \frac{b^{\ell+k}}{\ell!k!} &= \sum_{n=j+1}^{2j} \sum_{\ell=1}^n \frac{b^n}{\ell!(n-\ell)!} \\ &\leq \sum_{n=j+1}^{2j} \frac{b^n}{n!} \sum_{\ell=0}^n \frac{n!}{\ell!(n-\ell)!} \\ &= \sum_{n=j+1}^{2j} \frac{(2b)^n}{n!}. \end{aligned}$$

This estimate goes to 0 as  $j \rightarrow \infty$  since  $(2b)^n/n!$  is a term in the expansion of  $\exp(2b)$ .

On the other hand,

$$\begin{aligned} & \|S_j(A)S_j(B) - \exp(A)\exp(B)\| \\ & \leq \|\exp(A)\| \cdot \|S_j(B) - \exp(B)\| + \|S_j(B)\| \cdot \|S_j(A) - \exp(A)\| \\ & \leq \exp(b)(\|S_j(B) - \exp(B)\| + \|S_j(A) - \exp(A)\|) \\ & \rightarrow 0. \end{aligned}$$

Moreover  $\|S_j(A+B) - \exp(A+B)\| \rightarrow 0$  so by the triangle inequality the result holds.  $\blacksquare$

The family of matrices  $P(t) = \exp(tG)$  is called a semigroup because  $P(0) = I$  and  $P(t+s) = P(t)P(s)$ . To see this, just remark that the matrices  $A = sG$  and  $B = tG$  commute and apply the above lemma.

## 9.5 Algebraic Results

The notion of an equivalence class is used in the text. Consider a partition of some non-empty set  $X$ . We define a relation on  $X$  by saying  $x \sim y$ , if  $x$  and  $y$  belong to the same partition set. The relation  $\sim$  has the following properties

- $x \sim x$  for every  $x$  (reflexivity);
- $x \sim y \Rightarrow y \sim x$  (symmetry);
- $x \sim y$  and  $y \sim z \Rightarrow x \sim z$  (transitivity).

Any relation which possesses these three properties is called an *equivalence relation* on  $X$ .

The following lemma is a well known consequence of the fact that the units over the integers form a Euclidean ring (see Lemma 3.8 in Herstein (1975) for instance).

**Lemma 9.19** *If  $[1]$  is the greatest common divisor of the support of  $f$ ; i.e.  $\{x : f(x) > 0\}$ , then for any unit  $[d]$ , there exist positive integers  $\{p_i\}_{i=1}^{\ell_1}$  and  $\{n_i\}_{i=1}^{\ell_2}$  along with units  $\{x_i\}_{i=1}^{\ell_1}$  and  $\{y_i\}_{i=1}^{\ell_2}$  from the support of  $f$  such that*

$$\sum_{i=1}^{\ell_1} p_i x_i - \sum_{i=1}^{\ell_2} n_i y_i = [d].$$

**Proof:** Since  $[1]$  is the greatest common divisor of the support of  $f$  there exist a finite number of elements  $\{v_i : i = 1, \dots, \ell\}$  in the support of  $f$  with greatest common divisor equal to  $[1]$ . Consider the set  $A$  of all units represented by

$$A = \left\{ \sum_{i=1}^{\ell} m_i v_i : \text{where } m_i \text{ is an integer} \right\}.$$

Let  $s$  be the smallest positive unit in  $A$ . Let  $x \in A$  so by division  $x = ts + r$  where the remainder  $r$  satisfies  $0 \leq r < s$ . However  $s \in A$  so  $x - ts \in A$  which implies

$r \in A$ . This means  $r = 0$  since  $s$  is the smallest positive unit in  $A$ ! We conclude the elements of  $A$  are multiples of  $s$ .

This means  $\{v_j = t_j s : j = 1, \dots, \ell\}$  since each  $v_i \in A$  because  $v_j = \sum_{i=1}^{\ell} \delta_j(i) v_i$  where  $\delta_j(i)$  is 1 only if  $i = j$  and 0 otherwise. If  $s$  is not [1] then all the  $v$ 's have a common divisor. Since this is false we conclude  $s = [1]$  and hence  $A$  is all the units.

This means there exist integers  $m_i$  such that  $\sum_{i=1}^{\ell} m_i v_i = [d]$ , where  $[d]$  is any unit. Split this sum into the positive and negative coefficients so  $\sum_{i=1}^{\ell_1} p_i x_i - \sum_{i=1}^{\ell_2} n_i y_i = [d]$  where  $\{x_i\}_{i=1}^{\ell_1}$  and  $\{y_i\}_{i=1}^{\ell_2}$  are in the support of  $f$  and  $\{p_i\}_{i=1}^{\ell_1}$  and  $\{n_i\}_{i=1}^{\ell_2}$  are positive integers. ■

## 9.6 Further Reading

Feller Volume I is the best example of how much can be done with discrete random variables. Any serious student of probability should own a copy. Ross's Dover Classic is a readable introduction to applied probability but is now somewhat dated. The problem set is excellent. The book by Billingsley (1979) often referred to in the text is an excellent introduction to measure theoretic probability. The ATM standards are set by the ATM forum ([www.atmforum.org](http://www.atmforum.org)) and TCP/IP standard are set by the Internet Engineering Task Force ([www.ietf.org](http://www.ietf.org)) but almost any journal treating computer communications will have some information. The quality control standards are best read in the original so see the bibliography under Quality Control Standards.

The approximation of the binomial by a Poisson random variable dates back to Siméon D. Poisson (1781-1840) but the coupling approximation given here is inspired by the paper by Hodges and LeCam (1960). The discrete approach taken here is a bit unusual but it has the advantage of avoiding complicated conditioning arguments. The Poisson process is a fundamental building block for constructing other processes. For more on this, see the book by Brémaud.

The chapter on Markov chains is fairly standard. The seminal book by Orey inspired the author's treatment. Orey's book gives extensions to Markov chains on general state spaces. The classic book by Spitzer gives a modern potential theoretic treatment which is of interest to queueing theorists. The nonparametric cusum is developed in McDonald (1990) and an optimal choice for the anchor is discussed.

The original renewal theorem for discrete i.i.d. random variables is given in Feller Volume I. The coupling proof given here is just another in a long list going back to Doeblin (1941). The text by Meyn and Tweedie summarizes ideas developed by Athreya, Ney and Nummelin. The author also played a part (see Athreya, McDonald and Ney (1978) in the American Mathematical Monthly and Athreya, K.B., McDonald, D. and Ney, P. (1978)). The coupling proof using the Bernoulli part decomposition for nonidentical, independent random variables is a simplification of the results in McDonald (1978). Another interesting application is the proof of the Local Limit Theorem as in McDonald (1979b) and Davis and McDonald

(1994). The book by Asmussen (1987) gives a high level review of renewal theory and semi-Markov processes with applications to queueing.

Feller Volume II is an encyclopedia of good ideas including an introduction to the generator of a Markov process, although the emphasis is towards diffusions not jump processes. The more modern book by Ethier and Kurtz is recommended for obtaining a solid foundation in continuous time Markov processes. The construction of Markov processes with bounded jump rates based on uniformization has many advantages and all the intricacies of explosions and non-uniqueness of the solution to the forward equations are avoided. For the full story consult Chung (1967). The book by Kelly (1979) contains lots of clever examples and problems for reversible processes. Walrand's book on queueing networks is an excellent survey of all the mathematical tools used for studying networks. The bibliography there gives the state of the art in queueing networks. The Kelly networks are often called BCMP networks because they were discovered simultaneously by Kelly and Baskett, Chandy, Muntz and Palacios. Also the Bramson network is a direct descendent of the unstable deterministic networks proposed by Lu and Kumar (1991).

The chapter on Markov decision theory inspired by the book *Great Expectations* by Chow Siegmund and Robbins. The book by Puterman provides a fairly recent reference. The review article by Arapostathis et al provides up to date results on the average cost criterion. Only Markovian problems are considered and martingales have been avoided. The underlying principle is to solve finite horizon problems first and then approximate infinite horizon problems. The crowning achievement is the proof of the optimality of the Cusum as in Moustakides (1986).

## 9.7 Bibliography

- Arapostathis, A., Borkar, V. S., Fernandez-Gaucherand, E., Ghosh, M. K., and Marcus, S. I. (1993) Discrete-time controlled Markov processes with average cost criterion, a survey. *SIAM Journal on Control and Optimization*, 31 , 282-344.
- Asmussen, S. (1987). *Applied Probability and Queues*. John Wiley & Sons, New York.
- Athreya, K.B., McDonald, D., Ney, P. (1978a). Coupling and the renewal theorem. *Amer. Math. Monthly*, Vol.85, No.10, 809-814.
- Athreya, K.B., McDonald, D., Ney, P. (1978b). Limit theorems for semi-Markov processes and renewal theory for Markov chains. *Ann. Probability*, Vol.6, No.5, 788-797.
- Baskett, F., Chandy, K. M., Muntz, R. R., Palacios, F. (1975). Open, closed and mixed networks of queues with different classes of customers. *J.A.C.M.*, 22, 248-260.
- Billingsley, P. (1979). *Probability and Measure*. John Wiley & Sons, New York.
- Bramson, M. (1994). Instability of FIFO queueing networks. *Ann. Appl. Probab.* Vol. 4, 414-431.
- Brémaud, P.(1981). *Point Processes and Queues*. Springer-Verlag, New York.
- Brook, D., Evans, D. A. (1972). An approach to the probability distribution of cusum run length. *Biometrika*, Vol. 59, 539-549.
- Chow, Y. S., Robbins, H., Siegmund, S. (1971). *Great Expectations: The Theory of Optimal Stopping*. Houghton Mifflin Company, Boston.
- Chouinard, A., McDonald, D. (1985). A characterization of non-homogeneous Poisson processes. *Stochastics*, Vol. 15, pp. 113-119.
- Chung, K. L. (1967). *Markov Chains with Stationary Transition Probabilities*. 2nd ed. Springer-Verlag, New York.
- Dai, J. G. (1996). On the positive Harris recurrence for multiclass queueing networks: a uniform approach via fluid limit models. *Ann. Appl. Probab.*, 5, 49-77.
- Davis, B., McDonald, D. (1994). An Elementary Proof of the Local Central Limit Theorem. *Journal of Theoretical Probability Theory*, 8, 693-701.



- Dembo, A., Zeitouni, O. (1998). *Large Deviations Techniques and Applications*. Jones and Bartlett, Boston, 1993. Second edition, Springer, New York.
- Dodge, H. F., Romig, H. G. (1929). A method of sampling inspection. *Bell System Technical Journal*, 8, 613-631.
- Dodge, H. F., Romig, H. G. (1959). *Sampling Inspection Tables; Single and Double Sampling*. 2nd Ed., John Wiley, New York.
- Doebelin, W. (1940). Elements d'une théorie générale des chaînes simples constants de Markov, *Ann. Scient., Ec. Norm. Sup.*, Paris, III Ser. Vol. 57 61-111.
- Dubins, L. E., Savage, L. J. (1965). *How to Gamble if You Must: Inequalities for Stochastic Processes*. McGraw-Hill, New York.
- Ethier, S. N., Kurtz, T. G. (1986). *Markov Processes, Characterization and Convergence*. John Wiley, New York.
- Feller, W. (1957). *An Introduction to Probability Theory and Its Applications*. Vol. I. John Wiley & Sons, New York.
- Feller, W. (1971). *An Introduction to Probability Theory and Its Applications*. Vol. II. John Wiley & Sons, New York.
- Foster, F. G. (1953). On the stochastic matrices associated with certain queueing processes. *Ann. Math. Statist.*, Vol. 23, 355-360.
- Glasserman, P., Yao, D. D. (1994). Monotone optimal control of permutable GSMPs. *Mathematics of Operations Research*, Vol. 19, 449-476.
- Herstein, I. N. (1975). *Topics in Algebra, second edition*. John Wiley & Sons, New York.
- Hodges, J. L., Jr., LeCam, L. (1960). The Poisson approximation to the Poisson binomial distribution. *Ann. Math. Statist.*, Vol. 31, 737-740.
- Kelly, F. P. (1979). *Reversibility and Stochastic Networks*. John Wiley & Sons, New York.
- Kleinrock, L. (1975). *Queueing Systems Volume I: Theory*. John Wiley & Sons, New York.
- Kleinrock, L. (1976). *Queueing Systems Volume II: Computer Applications*. John Wiley & Sons, New York.
- Little, J.D.C. (1961). A proof of the queueing formula  $L=\lambda W$ . *Oper. Res.*, 9, 383-387.

- Lu, S. H., Kumar, P. R. (1991). Distributed scheduling based on due dates and buffer priorities. *IEEE Transactions on Automatic Control*, 36, 1406-1416.
- McDonald, D. (1978). On semi-Markov and semi-regenerative processes I, *Zeitschrift für Wahrscheinlichkeitstheorie Verw. Gebiete*, 42, 261-277.
- McDonald, D. (1978). On semi-Markov and semi-regenerative processes II, *Annals of Probability*, Vol. 6, No. 6, 995-1014.
- McDonald, D. (1979a). A local limit theorem for large deviations of sums of independent, non-identically distributed random variables. *Ann. Probability*, Vol. 7, 526-531.
- McDonald, D. (1979b). On local limit theorems for integer valued random variables. *Theory of Probability and Its Applications*, Vol. 24, No.3, 613-619.
- McDonald, D. (1980). On the Poisson approximation to the multinomial distribution. *Canadian Journal of Statistics*, Vol. 8, No.1, 115-118.
- McDonald, D. (1985). A characterization of non-homogeneous Poisson processes. *Stochastics*, 15, 113-119.
- McDonald, D. (1989). On nonhomogeneous, spatial Poisson processes. *Can. J. Stat.*, Vol. 17, No. 2, 183-195.
- McDonald, D. (1990). A cusum procedure based on sequential ranks. *Naval Research Logistics*, Vol. 37, 627-646.
- Meyn, S.P. and Tweedie, R.L. (1993). *Markov Chains and Stochastic Stability*, Springer Verlag, New York.
- Moustakides, G. V. (1986). Optimal stopping times for detecting changes in distribution. *Annals of Statistics*, Vol. 14, No. 4, 1379-1387.
- Orey, S. (1971). *Limit Theorems for Markov Chain Transition Probabilities*. Van Nostrand Reinhold Company, London.
- Page, E. S. (1954). Continuous inspection themes. *Biometrika*, 41, 100-15.
- Pakes, A. G. (1969). Some conditions of ergodicity and recurrence of Markov chains. *Oper. Res.*, 17, 1058-1061.
- Poisson, D. S. (1837). *Recherches sur la probabilité des jugements en matière criminelle et en matière civile, précédées des règles générales du calcul des probabilités*. Paris
- Puterman, M. L. (1994). *Markov Decision Theory*, Wiley, New York.

- Ross, S. M. (1992). *Applied Probability Models with Optimization Applications*. Dover Publications.
- Seneta, E. (1981). *Non-negative matrices and Markov chains*. 2nd ed. Springer Verlag, New York.
- Shiryayev, A. N. (1978). *Optimal Stopping Rules*. Springer-Verlag, New York.
- Spitzer, F. (1964). *Principles of Random Walk*. Springer-Verlag, New York.
- Walrand, J. (1988). *An Introduction to Queueing Networks*. Prentice Hall, New Jersey.
- Yashchin, E. (1985). On the Analysis and Design of Cusum-Shewhart Control Schemes. *IBM Journal of Research and Development*, 29, 377-191.

## Quality Control Standards:

MIL-STD-105D: 1963 American national standard procedures and tables for inspection by attributes, US Defense Department, 64 pp.

MIL-STD-1916: 1996 DOD Preferred methods for acceptance of produce, US Defense Department, 33 pp.

MIL-STD-1235B: Single- and multi-level continuous sampling procedures for attributes (US Department of Defense 1981b).

ISO 2859 Part 0: Sampling procedures for inspection by attributes - Introduction to the ISO 2859 attribute sampling system.

ISO 2859-1: 1989 Sampling procedures for inspection by attributes - Part 1: Sampling plans indexed by acceptable quality level (AQL) for lot-by-lot inspection.

ISO 2859-2: 1985 Sampling procedures for inspection by attributes - Part 2: Sampling plans indexed by limiting quality (LQ) for isolated lot inspection.

ISO 2859-3.2: Sampling procedures and charts for inspection by attributes - Skip lot sampling procedures.

ISO 8258 Shewhart control charts.

BS 5700: 1984 Guide to process control using quality control chart methods and CuSum techniques.

BS 5703: Part 1: 1980 Guide to data analysis and quality control using CuSum techniques. Part 1. Introduction to CuSum charting.

BS 5703: Part 2: 1980 Guide to data analysis and quality control using CuSum techniques. Part 2. Decision rules and statistical tests for CuSum charts and tabulations.

BS 5703: Part 3: 1981 Guide to data analysis and quality control using CuSum techniques. Part 3. CuSum methods for process/quality control by measurement.

BS 5703: Part 4: 1982 Guide to data analysis and quality control using CuSum techniques. Part 4. CuSums for counted/attributes data.

## 9.8 Solutions to Selected Problems

### 9.8.1 Solutions to Selected Exercises in Chapter 1

1.4: The key idea is to reduce the probability calculations to counting. We must therefore construct an equiprobable model. One way would be to define the sample space  $S$  as the set of all subsets of 5 distinct elements drawn from a deck of 52. The associated  $\sigma$ -algebra is the just the set of all subsets of  $S$  and is irrelevant for our calculations. The equiprobable measure assigns an equal weight to each sample point and since there are 52 choose 5 sample points in  $S$  each sample point has probability  $1/2598960$ . We are interested in the subset  $A$  of points which has 4 kings. The 5th card in the deck can be chosen in 48 different ways (other than

being a king). Hence  $P(A) = \#A/\#S = 48/2598960$ .

**1.5:** This is a great way to make a bit of pocket money. If  $n$  is 50 or so make an announcement that you are willing to bet even money that there are indeed people with the same birthdate in the classroom. Circulate a sheet of paper and have each person write down his birthday in the format (month, day). Look for a match. The chances are you will win your bet.

To calculate the chance of winning the key idea is to reduce probability calculations to counting. One sheet of paper with  $n$  dates  $(x_1, x_2, \dots, x_n)$  represents one sample point. Each of the coordinates of this vector could be any one of 365 dates (we will forget leap years as an approximation). The first coordinate can be chosen in 365 ways and the second can be chosen in 365 ways so the first two can be chosen in  $365 \times 365$  ways. The third can be chosen in 365 ways so the first three can be chosen in  $365^3$  ways. Continuing in this way, the number of different sample points is  $365^n$ . We will assume each of these sample points is equally likely. This is a reasonable approximation although we know very well that marriages often take place in the spring so birthdays tend to fall eight months later. We therefore assume we have an equiprobable model.

The event of interest is the set of sample points  $A$  with two or more coordinates the same. It is easier to describe the complement  $A'$  of sample points with no coordinates the same and since  $P(A) = 1 - P(A')$  we can get  $P(A)$  from  $P(A')$ .

$$A' = \{(x_1, x_2, \dots, x_n) : \text{all the } x_i\text{s are different}\}.$$

The first coordinate of a point in  $A'$  can be chosen in 365 ways but the second can only be chosen in 364 ways avoiding the first choice. This makes  $365 \times 364$  ways. Next the third coordinate can be chosen in 363 ways giving  $365 \times 364 \times 363$  ways. Continuing in this way we see the number of points in  $A'$  is  $365 \times 364 \times \dots \times (365 - n + 1)$ . Hence

$$P(A') = \frac{365 \times \dots \times (365 - n + 1)}{365^n} \text{ so } P(A) = 1 - \frac{365 \times \dots \times (365 - n + 1)}{365^n}.$$

Get Mathematica to calculate this value for you. At  $n = 22$   $P(A) < 1/2$  so with only 22 people there is a better than even chance of a matched birthday. The probability gets so big above 50 people that you are practically sure to win. Winning is like taking candy from a baby.

**1.10:** a): No, the histogram of the sample will follow the histogram of the population which in this case is not normal because of the two bumps. The expected value of the sample average is the mean of the population; i.e.  $\bar{X}$  is an unbiased estimator of the mean of the population and the expected value of the sample standard deviation is approximately equal to the population standard deviation (in fact a modified sample variance  $S^2 = \sum_{k=1}^n (X_k - \bar{X})^2 / (n - 1)$  is an unbiased estimator of  $\sigma^2$ ). We don't exactly know the mean of the population or the population standard deviation but the sample of 2,000 sacks gives a pretty good estimate. The sample average of this large sample is 4.9961 with a sample standard deviation of

0.5496. The standard error of the mean is 0.0123 so with 95 percent confidence the true population mean lies within 4.9961 plus or minus 0.0246. Hence it is unwise to report more than one decimal place. Hence the sample average of one lot will hence be approximately b): 5.0 and the sample standard deviation is approximately c): 0.55 (We need a finer analysis to estimate the precision of the estimate for the standard deviation).

The population of sums of the weights of 100 sacks on a skid will follow the normal curve by the central limit theorem. The sample histogram of the total weights of 75 skids will follow the population histogram; that is d): a normal histogram. The expected value of the sample mean is equal to the population mean and the population mean is the expected value of the weight of 100 sacks and that is approximately e): 500. The standard deviation of this sample histogram will be close to the standard deviation of the population of sums which is approximately f):  $\sqrt{100} \cdot 0.55 = 5.5$

The area under histogram of sums of weight of 100 sacks to the right of 400 kilograms is approximately equal to the area under a standard normal to the right of  $(400-500)/5.5 = -18.2$  standard units. Hence g): 100% of the skids will have a total weight greater than 400 kilograms. The 10<sup>th</sup> percentile of a standard normal is approximately -1.28 standard units by looking up in the normal table. This corresponds to  $500 - 1.28 \cdot 5.5 = 492.96$  or roughly h): 492 kilograms.

**1.11:** Define every event in sight! Let  $A, B, C$  represent the events that the bulb chosen at random comes from supplier A, B or C respectively. Let  $D$  be the event that this bulb is defective and let  $N$  be the complementary event the bulb is non-defective. Let  $P$  represent the equiprobable measure of picking a bulb among all possible bulbs. By hypothesis  $P(A) = .7$ ,  $P(B) = .2$  and  $P(C) = .1$ . Moreover  $P(D|A) = 0.05$ ,  $P(D|B) = 0.03$  and  $P(D|C) = .2$ .

$$\begin{aligned} P(D) &= P(D \cap A) + P(D \cap B) + P(D \cap C) \\ &= P(D|A)P(A) + P(D|B)P(B) + P(D|C)P(C) \\ &= 0.05 \cdot 0.7 + 0.03 \cdot .2 + 0.2 \cdot 0.1 = 0.061 \end{aligned}$$

Hence the probability a defective bulb is sampled is a 6.1%.

$$P(C|D) = \frac{P(C \cap D)}{P(D)} = \frac{P(D|C)P(C)}{P(D)} = \frac{0.2 \cdot 0.1}{0.061}$$

so the probability the defective bulb came from company C is 0.33.

### 9.8.2 Solutions to Selected Exercises in Chapter 2

**2.1:** a) The marginal p.m.f.  $p_X(x) = \sum_y p_{X,Y}(x,y)$  so  $p_X(-1) = 1/3$ ,  $p_X(0) = 17/18$ ,  $p_X(1) = 5/18$ .

b) The conditional distribution  $p_{Y|X}(y|x) = p_{X,Y}(x,y)/p_X(x)$  so

$$p_{Y|X}(-1|-1) = 1/6, p_{Y|X}(0|-1) = 1/6, p_{Y|X}(1|-1) = 1/3, p_{Y|X}(2|-1) = 1/3.$$

Hence  $E(Y|X = -1) = (-1)(1/6) + (0)(1/6) + (1)(1/3) + (2)(1/3)$ . The other conditional expectations are similar.

c)  $X$  and  $Y$  are independent if and only if  $p_{X,Y}(x,y) = p_X(x) \cdot p_Y(y)$  for all  $x$  and  $y$ . This is false for  $x = -1$  and  $y = 1$  so  $X$  and  $Y$  are dependent.

d)  $Eh(X,Y) = \sum_{x,y} h(x,y)p_{X,Y}(x,y)$  Hence,

$$\begin{aligned} E\frac{Y}{X+2} &= \left(\frac{-1}{-1+2}\right)\frac{1}{18} + \left(\frac{0}{-1+2}\right)\frac{1}{18} + \left(\frac{1}{-1+2}\right)\frac{1}{9} + \left(\frac{2}{-1+2}\right)\frac{1}{9} \\ &= \left(\frac{-1}{0+2}\right)\frac{1}{8} + \left(\frac{0}{0+2}\right)\frac{1}{18} + \left(\frac{1}{0+2}\right)\frac{1}{12} + \left(\frac{2}{0+2}\right)\frac{1}{8} \\ &= \left(\frac{-1}{1+2}\right)\frac{1}{12} + \left(\frac{0}{1+2}\right)\frac{1}{18} + \left(\frac{1}{1+2}\right)\frac{1}{12} + \left(\frac{2}{1+2}\right)\frac{1}{18} \\ &= 181/432 \end{aligned}$$

2.2: a)  $f_X(x) = \sum_y f_{X,Y}(x,y)$  so adding across the rows we get

$$\begin{array}{cccc|c} f(x,y) & y=0 & y=1 & y=2 & f_X(x) \\ x=1 & 1/6 & 1/6 & 0 & 1/3 \\ x=2 & 1/6 & 0 & 1/6 & 1/3 \\ x=3 & 1/12 & 1/6 & 1/12 & 1/3 \end{array}$$

i.e.

$$\begin{array}{ccc} x=1 & x=2 & x=3 \\ f(x) & 1/3 & 1/3 & 1/3 \end{array}$$

b) 0

c)  $f_{Y|X}(y|x) = f_{X,Y}(x,y)/f_X(x)$  so  $f_{Y|X}(y|3) = f_{X,Y}(3,y)/f_X(3)$  and

$$\begin{array}{ccc} y=0 & y=1 & y=2 \\ f_{Y|X}(y|3) & 1/4 & 1/2 & 1/4 \end{array}$$

d)

$$E(Y^2|X=3) = \sum_y y^2 f_{Y|X}(y|3) = 0^2 \cdot \frac{1}{4} + 1^2 \cdot \frac{1}{2} + 2^2 \cdot \frac{1}{4} = \frac{3}{2}.$$

e) Calculate

$$E((X+Y)^2|X=3) = \sum_y (3+y)^2 f_{Y|X}(y|3) = 3^2 \cdot \frac{1}{4} + 4^2 \cdot \frac{1}{2} + 5^2 \cdot \frac{1}{4} = \frac{33}{2}.$$

f)  $X$  and  $Y$  are independent only if  $f_{X,Y}(x,y) = f_X(x) \cdot f_Y(y)$  for all  $x$  and  $y$ . Note that  $f_X(1) = 1/3$  and  $f_Y(2) = 1/4$  but  $f_{X,Y}(1,2) = 0$  so  $X$  and  $Y$  are not independent.

**2.13:**

$$\begin{aligned} EN &= \sum_{n=1}^{\infty} n f_N(n) = \sum_{n=1}^{\infty} \sum_{k=1}^{\infty} \{k \leq n\} f_N(n) \\ &= \sum_{k=1}^{\infty} \sum_{n=1}^{\infty} \{k \leq n\} f_N(n) \text{ by Fubini's theorem} \\ &= \sum_{k=1}^{\infty} (1 - F(k-1)) = \sum_{k=0}^{\infty} (1 - F(k)). \end{aligned}$$

**2.14:** If  $X \geq 0$  has distribution  $F$  and  $X_k = \min\{X, k\}$  then

$$\begin{aligned} EX_k &= \int_0^{\infty} \min\{X, k\} dF(x) = \int_0^k x dF(x) + \int_k^{\infty} k dF(x) \\ &= xF(x)|_0^k - \int_0^k F(x) dx + k(1 - F(k)) \\ &= k - \int_0^k F(x) dx \end{aligned}$$

### 9.8.3 Solutions to Selected Exercises in Chapter 3

**3.3:** Let  $U$  be a uniform on  $[0, 1]$  and define  $Z = F^{-1}(U)$ . Note that

$$F_Z(v) = P(Z \leq v) = \mu(E_v)$$

where  $\mu$  is Lebesgue measure on  $[0, 1]$ ; i.e.  $\mu$  measures the lengths of intervals and

$$E_v = \{s \in [0, 1] : F^{-1}(s) \leq v\} = \{s \in [0, 1] : \min\{t : F(t) \geq s\} \leq v\}.$$

Note that if  $F$  is strictly increasing then  $E_v = \{s \leq F(v)\}$  so in that case  $F_Z(v) = \mu(\{s \leq F(v)\}) = F(v)$  so  $Z$  really does have distribution  $F$ .

In cases with jumps we have to be more careful. Let  $\bar{v} = \inf\{z > v : F(z) > F(v)\}$ . Then  $E_v = \{s : s \leq F(\bar{v}^-)\}$  where  $F(\bar{v}^-) = \lim_{z \uparrow \bar{v}} F(z)$ . This is true because if  $s \leq F(\bar{v}^-)$  then  $\min\{t : F(t) \geq s\} \leq v$  so  $s \in E_v$ . Similarly if  $s \in E_v$  then  $\min\{t : F(t) \geq s\} \leq v$  so  $s \leq F(\bar{v}^-)$ . We conclude

$$F_Z(v) = \mu(\{s : 0 \leq s \leq F(\bar{v}^-)\}) = F(\bar{v}^-) = F(v)$$

so again  $Z$  really does have distribution  $F$ .

**3.5:** There is one chance in 5 the component dies in the first 1,000 hours and 4 chances in 5 it dies after that. If it dies in the first 1,000 hours the distribution is uniform. If it dies after that the lifetime is 1000 hours plus and exponential. Let  $B$  be a Bernoulli random variable with probability  $4/5$  of taking the value one.



Let  $U$  be uniform on  $[0, 1000]$  and let  $X$  be exponential with mean 4000 hours. Make  $B$ ,  $U$  and  $X$  independent. We note that the lifetime can be represented as  $L = (1 - B)U + B(1000 + X)$ .

a)  $EL = E(1 - B) \cdot EU + EB \cdot E(1000 + X) = \frac{1}{5} \cdot 500 + \frac{4}{5}(1000 + 4000) = 4100$ . Of course if you want to do it the long way then

$$\begin{aligned} EL &= \int_{-\infty}^{\infty} xf(x)dx = \int_0^{1000} x \frac{1}{5000} dx + \int_{1000}^{\infty} x \frac{4}{20000} \exp(-(x - 1000)/4000) dx \\ &= \frac{1}{5000} \left[ \frac{x^2}{2} \right]_{x=0}^{x=1000} + \frac{4}{5} \int_0^{\infty} (x + 1000) \frac{1}{4000} \exp(-x/4000) dx \\ &= 100 + \frac{4}{5} \left( \int_0^{\infty} x \frac{1}{4000} \exp(-x/4000) dx + 1000 \int_0^{\infty} \frac{1}{4000} \exp(-x/4000) dx \right) \\ &= 100 + \frac{4}{5}(4000 + 1000) = 4100 \end{aligned}$$

b)

$$\begin{aligned} P(L > 3000) &= \int_{3000}^{\infty} \frac{4}{20000} \exp(-(x - 1000)/4000) dx \\ &= \frac{4}{5} \int_{2000}^{\infty} \frac{1}{4000} \exp(-x/4000) dx \\ &= \frac{4}{5} \exp(-2000/4000) = \frac{4}{5} \exp(-1/2). \end{aligned}$$

c)

$$\begin{aligned} E \exp(s)L &= E \exp(s[(1 - B) \cdot EU + EB \cdot E(1000 + X)]) \\ &= E \exp(s(1 - B)U) \cdot E \exp(sB(1000 + X)) \\ &= \left[ \frac{1}{5} E \exp(sU) + \frac{4}{5} E \exp(0) \right] + \left[ \frac{1}{5} E \exp(0) + \frac{4}{5} E \exp(s(1000 + X)) \right] \\ &= \left[ \frac{1}{5} E \exp(sU) + \frac{4}{5} E \exp(0) \right] + \left[ \frac{1}{5} E \exp(0) + \frac{4}{5} \exp(1000s) E \exp(sX) \right] \\ &= \frac{1}{5} \frac{1}{1000s} (e^{1000s} - 1) + 1 + \frac{4}{5} \exp(1000s) \frac{1/4000}{1/4000 - s} \end{aligned}$$

for  $s < 1/4000$  since

$$E \exp(sX) = \frac{1/4000}{1/4000 - s} \text{ and } E \exp(sU) = \int_0^{1000} e^{sx} \frac{1}{1000} dx = \frac{1}{1000s} (e^{1000s} - 1).$$

Alternatively one could do the integrals

$$\begin{aligned} EL &= \int_{-\infty}^{\infty} e^{sx} f(x) dx \\ &= \int_0^{1000} e^{sx} \frac{1}{5000} dx + \int_{1000}^{\infty} e^{sx} \frac{4}{20000} \exp(-(x - 1000)/4000) dx. \end{aligned}$$

- d) Absolutely not. The sample histogram tends to follow the population histogram i.e.  $f$  and this is not normal.
- e) The law of numbers says the sample mean will be close to the population mean and hence close to the answer in a)
- f) Let the four lifetimes be  $L_1, L_2, L_3$  and  $L_4$ . The probability at least one works after 3,000 hours is one minus the probability they all fail before 3,000 hours.

$$\begin{aligned} P(L_1 < 3000, L_2 < 3000, L_3 < 3000, L_4 < 3000) \\ &= P(L_1 < 3000)P(L_2 < 3000)P(L_3 < 3000)P(L_4 < 3000) \\ &= P(L_1 < 3000)^4 = (1 - P(L_1 \geq 3000))^4 = (1 - \frac{4}{5} \exp(-1/2))^4 \end{aligned}$$

- by part b). Hence the probability at least one keeps working is  $1 - (1 - \frac{4}{5} \exp(-1/2))^4$ .
- 3.9:** a) The probability that there are no drug users in a group of  $k$  is  $(1 - p)^k$  so the probability every member of the group must be tested is  $1 - (1 - p)^k$
- b) Hence the expected number of tests per group of  $k$  is  $1 \cdot (1 - p)^k + (k + 1)(1 - (1 - p)^k)$ . For  $n$  groups the expected number of tests is the sum of the expected values i.e.  $n(1 \cdot (1 - p)^k + (k + 1)(1 - (1 - p)^k))$ .
- c)  $nk = N$ , the number of employees. If  $p$  is small then  $(1 - p)^k \approx 1 - kp$  so the above expectation is approximately

$$n(1 \cdot (1 - pk) + (k + 1)(pk)) = n + nk^2p = N/k + Npk.$$

We can minimize the expectation by find the derivative

$$\frac{d}{dk}(N/k + Npk) = -N/k^2 + Np.$$

Setting this to zero gives  $k = 1/\sqrt{p}$  so we take  $k$  to be the nearest integer to this value.

**3.13:** Represent the three lengths by  $L_1, L_2$  and  $L_3$  respectively.

- a) The total length is  $T = L_1 + L_2 + L_3$ .  $T$  is normal since a linear combination of independent normals is normal. The mean is the sum of the means and the variance is the sum of the variances. Hence  $ET = 4 + 2 + 2 = 8$  mm and  $\sigma_T^2 = .5^2 + .4^2 + .4^2 = 0.57$ .
- b)  $P(T \leq 10) = P((T - ET)/\sigma_T \leq (10 - 8)/\sqrt{0.57}) = P(Z \leq 2.647) = 0.9960$ . Hence the probability of a defective component is  $1 - .9960 = 0.004$

**3.14:**

$$P(\max\{X_1, \dots, X_n\} \leq t) = P(X_1 \leq t, \dots, X_n \leq t) = P(X_1 \leq t) \cdots P(X_n \leq t).$$

For  $0 \leq t \leq 1$ ,  $P(X_1 \leq t) = t$  so the above probability is  $t^n$ .

**3.16:** The moment generating of  $X$  is  $\phi_X(s) = \exp(\lambda_X(e^s - 1))$  and the moment generating of  $Y$  is  $\phi_Y(s) = \exp(\lambda_Y(e^s - 1))$ . The moment generating function of  $X + Y$  is  $\phi_X(s)\phi_Y(s) = \exp((\lambda_X + \lambda_Y)(e^s - 1))$  because of independence and we

recognize this to be the transform of a Poisson random variable with mean  $\lambda_X + \lambda_Y$ . We conclude  $X + Y$  is Poisson with this mean.

$$\begin{aligned}
 P(X = x | X + Y = n) &= P(X = x, X + Y = n) / P(X + Y = n) \text{ by Bayes} \\
 &= P(X = x, Y = n - x) / P(X + Y = n) \\
 &= P(X = x)P(Y = n - x) / P(X + Y = n) \text{ by independence} \\
 &= \exp(-\lambda_X) \frac{\lambda_X^x}{x!} \exp(-\lambda_Y) \frac{\lambda_Y^{n-x}}{(n-x)!} / ((\exp(-(\lambda_X + \lambda_Y))) \frac{(\lambda_X + \lambda_Y)^n}{n!}) \\
 &= \binom{n}{x} \frac{\lambda_X^x \lambda_Y^{n-x}}{(\lambda_X + \lambda_Y)^n} \\
 &= \binom{n}{x} \left( \frac{\lambda_X}{\lambda_X + \lambda_Y} \right)^x \left( \frac{\lambda_Y}{\lambda_X + \lambda_Y} \right)^{n-x}.
 \end{aligned}$$

Hence the conditional distribution of  $X$  is binomial.

**3.27:** Let  $N$  be the number of customers who enter the price club and let  $X_n$  represent the amount spent by the  $n^{\text{th}}$  customer. The total amount spent  $T$  is given by  $T = \sum_{n=1}^N X_n$ . If we condition on  $N$ ,

$$\begin{aligned}
 ET &= \sum_{m=1}^{\infty} E\left(\sum_{n=1}^m X_n | N = m\right) P(N = m) \\
 &= \sum_{m=1}^{\infty} E\left(\sum_{n=1}^m X_n\right) P(N = m) \text{ by independence} \\
 &= \sum_{m=1}^{\infty} mEX P(N = m) = ENEX = 2000 \cdot 110
 \end{aligned}$$

$Var(T) = ET^2 - (ET)^2$  and

$$\begin{aligned}
 ET^2 &= \sum_{m=1}^{\infty} E\left(\left(\sum_{n=1}^m X_n\right)^2 | N = m\right) P(N = m) \\
 &= \sum_{m=1}^{\infty} E\left(\sum_{n=1}^m X_n\right)^2 P(N = m) \text{ by independence} \\
 &= \sum_{m=1}^{\infty} \left( E\left(\sum_{n=1}^m X_n^2\right) + \sum_{1 \leq i \neq j \leq m} EX_i X_j \right) P(N = m) \\
 &= \sum_{m=1}^{\infty} (mEX^2 + m(m-1)(EX)^2) P(N = m) \\
 &= ENEX^2 + (EX)^2(EN^2 - EN)
 \end{aligned}$$

Therefore,

$$\begin{aligned} \text{Var}(T) &= ENEX^2 + (EX)^2(EN^2 - EN) - (EN)^2(EX)^2 \\ &= (EX)^2(EN^2 - (EN)^2) + EN(EX^2 - (EX)^2) \\ &= (EX)^2 \cdot \text{Var}(N) + EN \cdot \text{Var}(X) \end{aligned}$$

Hence

$$\text{Var}(T) = (\text{Var}(X) + (EX)^2)\text{Var}(N) + EN \cdot \text{Var}(X).$$

#### 9.8.4 Solutions to Selected Exercises in Chapter 4

4.5:

$$\begin{aligned} E[N^P(t) \cdot N^P(t+u)] &= E[N^P(t) \cdot (N^P(t+u) - N^P(t) + N^P(t))] \\ &= E[N^P(t) \cdot (N^P(t+u) - N^P(t))] + E[N^P(t)^2] \\ &= E[N^P(t)] E[N^P(t+u) - N^P(t)] + \text{Var}(N^P(t)) \\ &\quad + [EN^P(t)]^2 \\ &= (\lambda t)(\lambda u) + \lambda t + (\lambda t)^2 \end{aligned}$$

4.6: The Poisson process has rate 100/60 per minute.

a)

$$\begin{aligned} P(N(10) \geq 2) &= 1 - (P(N(10) = 0) + P(N(10) = 1)) \\ &= 1 - (\exp(-10 \cdot 100/60) + \exp(-10 \cdot 100/60)(10 \cdot 100/60)^1/1!) \\ &= 1 - (\exp(-10 \cdot 100/60) + \exp(-10 \cdot 100/60)(10 \cdot 100/60)) \end{aligned}$$

b)

$$\begin{aligned} P(N(10) = 2, N(20) = 4) &= P(N(10) = 2, N(20) - N(10) = 2) \\ &= P(N(10) = 2)P(N(20) - N(10) = 2) \\ &= P(N(10) = 2)^2 \\ &= (\exp(-10 \cdot 100/60)(10 \cdot 100/60)^2/2!)^2 \end{aligned}$$

c) The time in minutes until two calls arrives is an Erlang-2 distribution with parameter  $\lambda = 100/60$ .

4.10: Let the number of arrivals by time  $t$  be noted by  $N(t)$ . Given  $N(t) = n$  denote the arrival times by  $T_{(i)}$ ,  $i = 1, \dots, n$  there  $T_{(i)}$  is the  $i^{\text{th}}$  order statistic of  $n$  i.i.d. random variables uniformly distributed on  $[0, t]$ . Let  $V_i$  be the speed of

the  $i^{\text{th}}$  arrival. The number of cars in the interval  $[A, B]$  at time  $t$  is

$$\sum_{i=1}^{N(t)} \chi\{V_i \cdot (t - T_{(i)}) \in [A, B]\}.$$

We calculate the Laplace transform of this random variable:

$$\begin{aligned} & E \exp(\theta(\sum_{i=1}^{N(t)} \chi\{V_i \cdot (t - T_{(i)}) \in [A, B]\})) \\ &= \sum_{n=0}^{\infty} E \left( \exp(\theta \sum_{i=1}^n \chi\{V_i \cdot (t - T_{(i)}) \in [A, B]\}) | N(t) = n \right) P(N(t) = n) \\ &= \sum_{n=0}^{\infty} E \left( \exp(\theta \sum_{i=1}^n \chi\{\tilde{V}_i \cdot (t - T_i) \in [A, B]\}) | N(t) = n \right) P(N(t) = n) \\ &= \sum_{n=0}^{\infty} \left( E \left( \exp(\theta \chi\{\tilde{V} \cdot (t - T) \in [A, B]\}) \right) \right)^n P(N(t) = n) \end{aligned}$$

where we have reordered the order statistics and thereby reordered by  $V_i$  which we relabel the  $\tilde{V}_i$ . Since the  $V_i$  are i.i.d. independent of the arrival times so are the  $\tilde{V}_i$  and the distribution is the same. Also let  $T$  be uniform on  $[0, t]$  and let  $V$  be a speed with distribution  $G$ . Next, let  $p = P(\tilde{V} \cdot (t - T) \in [A, B])$  so the above reduces to

$$\begin{aligned} & \sum_{n=0}^{\infty} ((1 - p) + p \exp(\theta))^n P(N(t) = n) \\ &= \exp(-\lambda t + \lambda t ((1 - p) + p \exp(\theta))) \\ &= \exp(-\lambda p t (1 - \exp(\theta))). \end{aligned}$$

We recognize that the number of cars in the interval follows the Poisson distribution with mean  $\lambda p t$ . Finally

$$\begin{aligned} p &= \int_{v=0}^{\infty} \int_{0 \leq s \leq t, v \cdot s \in [A, B]} \frac{ds}{t} dG(s) \\ &= \frac{1}{t} \int_{v=0}^{\infty} \left( \frac{B}{v} \wedge t - \frac{A}{v} \wedge t \right) dG(s) \end{aligned}$$

Consequently the mean number of cars in the interval  $[A, B]$  is

$$\lambda \int_{v=0}^{\infty} \left( \frac{B}{v} \wedge t - \frac{A}{v} \wedge t \right) dG(s) \rightarrow (B - A) \lambda \rho$$

as  $t \rightarrow \infty$ , where  $\rho = \int_{v=0}^{\infty} \frac{1}{v} dG(s)$ .

Now start out with cars distributed along the line according to a Poisson process with intensity  $\lambda \rho$  having independent speeds with distribution  $H$  where  $H(v) = \int_0^v \frac{1}{s} dG(s) / \rho$ . Hence the number of cars in an interval  $[A, B]$  at time  $t$  consists of

those already present at the start and those who arrive later. The distribution of the latter is given above. Let  $N$  be the number of points already present between  $[0, B]$  and denote the location of these points by  $T_{(i)}$  and denote their speeds by  $V_i$  having distribution  $H$ . The Laplace transform of the distribution of the number of points in the interval from those initially present is

$$\begin{aligned} & E \exp(\theta \sum_{n=1}^N \chi\{T_{(i)} + V_i + t \in [A, B]\}) \\ &= \sum_{n=0}^{\infty} E \left( \exp(\theta \sum_{i=1}^n \chi\{T_{(i)} + V_i \cdot t \in [A, B]\}) | N(t) = n \right) P(N(t) = n) \\ &= \sum_{n=0}^{\infty} E \left( \exp(\theta \sum_{i=1}^n \chi\{T_i + \tilde{V}_i \cdot t \in [A, B]\}) | N(t) = n \right) P(N(t) = n) \\ &= \sum_{n=0}^{\infty} \left( E \left( \exp(\theta \chi\{T + \tilde{V} \cdot t \in [A, B]\}) \right) \right)^n P(N(t) = n) \end{aligned}$$

where  $T$  is uniformly distributed on  $[0, B]$ . Letting

$$q = E \left( \exp(\theta \chi\{T + \tilde{V} \cdot t \in [A, B]\}) \right)$$

we get the transform  $\exp(-\lambda \rho B q (1 - \exp(\theta)))$  as above. This is the transform of a Poisson distribution with mean  $\lambda \rho B q$ .

Next,

$$\begin{aligned} q &= \frac{1}{B} \int_{v=0}^{\infty} \int_{x=0}^B \chi\{A \leq x + vt \leq B\} dx dH(v) \\ &= \frac{1}{B} \int_{v=0}^{\infty} ((B - vt)^+ - (A - vt)^+) dH(v) \\ &= \frac{1}{B\rho} \int_{v=0}^{\infty} ((B - vt)^+ - (A - vt)^+) \frac{1}{v} dG(v) \end{aligned}$$

Hence the number of cars initially present in the interval at time  $t$  is Poisson with mean  $\lambda \int_{v=0}^{\infty} [(B - vt)^+ - (A - vt)^+] \frac{1}{v} dG(v)$ .

Hence the total number of customers in  $[A, B]$  at time  $t$  is Poisson with mean

$$\begin{aligned} & \lambda \int_{v=0}^{\infty} \left( \frac{B}{v} \wedge t - \frac{A}{v} \wedge t \right) dG(s) + \lambda \int_{v=0}^{\infty} ((B - vt)^+ - (A - vt)^+) \frac{1}{v} dG(v) \\ &= \lambda(B - A)\rho \end{aligned}$$

since  $(\frac{B}{v} \wedge t - \frac{A}{v} \wedge t) + ((\frac{B}{v} - t)^+ - (\frac{A}{v} - t)^+) = \frac{B}{v} - \frac{A}{v}$ .

We conclude that if we start out with a distribution of cars and speeds as above then the distribution of cars and speeds is the same at all times  $t$ . This is not to say the system is now fixed, far from it. Cars continue to enter the system and move

off along the highway. Only the distribution is fixed. This is called a statistical equilibrium.

**4.14:**

a) The expected number of calls is 800 so we expect to analyze 80 calls. Actually this is an approximation and to get an exact result we have to use renewal theory for Erlang-10 random variables.

b) This is an Erlang-10 distribution with  $\lambda = 100$  hours

c) It can't be Poisson because the interarrival time is not exponential.

**4.20:** Let  $N(t)$  represent a Poisson process with rate  $\lambda = 10$  calls per second.

a)

$$\begin{aligned} P(N(10) = 5, N(20) = 30) &= P(N(10) = 5, N(20) - N(10) = 25) \\ &= P(N(10) = 5)P(N(20) - N(10) = 25) \\ &= P(N(10) = 5)P(N(10) = 25) \\ &= \exp(-10 \cdot 10) \frac{100^5}{5!} \cdot \exp(-10 \cdot 10) \frac{100^{25}}{25!} \end{aligned}$$

b) The number of on-going calls follows a Poisson distribution with a mean equal to the load  $\rho = \lambda m_G$  where  $m_G = 138$  seconds is the mean duration of a call. Hence  $\rho = 10 \cdot 138$ . Let  $T$  be the number of calls holding at 1pm. Since a Poisson is approximately normal we can approximate

$$P(T > 1500) = \sum_{k=1501}^{\infty} \exp(-1380) \frac{1380^k}{k!}.$$

Just normalize

$$P(T > 1500) = P\left(\frac{T - ET}{\sigma_T} > \frac{1500 - 1380}{\sqrt{1380}}\right) \approx P(Z > 3.23) \approx 0.0012$$

c) At each arrival time of a Poisson process  $T_n$  we have an associated holding time  $X_n$ . We call  $X_n$  the mark associated with the arrival. If we look at the pair  $(T_n, X_n)$  we have a point process in  $R^2$ . Assume the  $X_n$  have cumulative distribution  $F$  then this two dimensional point process is in fact Poisson. The number of points in  $[s, t] \times [a, b]$  is Poisson since  $N(t) - N(s)$  is Poisson with parameter  $\lambda(t - s)$ . Suppose  $N = n$  then each of these points has probability  $p = F(b) - F(a)$  of falling in the interval  $[a, b]$ . Hence the number  $B(n)$  of these  $n$  points which fall in the interval has a binomial distribution with parameters  $p$  and  $n$ . It is easy to check that the thinned process  $B(N)$  has a Poisson distribution with mean  $p\lambda(t - s)$ . It is fairly easy to check that the numbers of points falling in disjoint regions are independent so we have independent Poisson increments for rectangles. By cutting up any region into intervals we can check that we have independent Poisson increments for disjoint regions.

Now consider the image of this two dimensional process on the real line if we project at 45 degrees; i.e.  $(T_n, X_n)$  is projected to  $T_n + X_n$ . This produces the

point process of departures on the real line. This process is Poisson. It suffices to remark that the number of departure points in disjoint intervals  $[u, v]$  and  $[s, t]$  corresponds to disjoint regions in  $R^2$ . The distribution of the number of points in these regions is Poisson with a mean proportional to  $v - u$  and  $t - s$  respectively. Hence the departure process is a homogeneous Poisson process.

### 9.8.5 Solutions to Selected Exercises in Chapter 5

**5.2:** In general the image of a Markov chain is not Markovian. In this case it suffices to check that the Markov property fails since

$$P_\alpha(Y_2 = 0 | Y_1 = 1, Y_0 = 0) \neq P_\alpha(Y_2 = 0 | Y_1 = 1).$$

Just use the definition of conditional probabilities and express the events for  $Y$  in terms of  $X$ . For example

$$\begin{aligned} P_\alpha(Y_2 = 0 | Y_1 = 1, Y_0 = 0) &= \frac{P_\alpha(Y_2 = 0, Y_1 = 1, Y_0 = 0)}{P_\alpha(Y_1 = 1, Y_0 = 0)} \\ &= \frac{P_\alpha(X_2 = 0, X_1 = 1, X_0 = 0) + P_\alpha(X_2 = 0, X_1 = 2, X_0 = 0)}{P_\alpha(X_1 = 1, X_0 = 0) + P_\alpha(X_1 = 2, X_0 = 0)} \\ &= \frac{\alpha(0)K_{01}K_{10} + \alpha(0)K_{02}K_{20}}{\alpha(0)K_{01} + \alpha(0)K_{02}} \end{aligned}$$

**5.10:**

$$\lim_{n \rightarrow \infty} P(X_n = a, X_{n+1} = c) = \lim_{n \rightarrow \infty} P(X_n = a)K_{ac} = \pi(a)K_{ac}.$$

**5.11:** This problem is a converse to Theorem 5.21. The watched process  $W_n$  on  $A$  discussed in Section 5.9 is certainly an irreducible stable Markov chain by Theorem 5.21 with stationary distribution  $\pi_A$ . Let  $N(T)$  be the number of visits of  $F$  by  $X_n$  up to time  $T$ . By Theorem 5.18, for  $j \in A$ ,

$$\begin{aligned} \pi(j) &= \lim_{T \rightarrow \infty} \frac{1}{T} \sum_{s=0}^{T-1} \chi\{X_s = j\} \\ &= \lim_{T \rightarrow \infty} \frac{N(T)}{T} \frac{1}{N(T)} \sum_{s=0}^{N(T)} \chi\{W_s = j\} \\ &= \pi(F)\pi_F(j). \end{aligned}$$

Hence  $\pi_F(j) = \pi(j)/\pi(F)$ .

**5.17:** a) Let  $S = \{0, 1, 2\}$  where state 0 represents the state of a properly aligned machine just before it is loaded for a new part, where state 1 represents the state of an improperly aligned machine just before a new part is loaded and where state



2 represents the state when the machine is off-line and being repaired.

$$K = \begin{pmatrix} .98 & (.02)(.8) & (.02)(.2) \\ 0 & .8 & .2 \\ 1 & 0 & 0 \end{pmatrix}.$$

Note that even a properly aligned machine can be misaligned in loading and then immediately drill off-center with probability  $(.02)(.2)$ .

b) Solve for  $\pi K = \pi$ ; i.e.

$$(\pi(0), \pi(1), \pi(2)) = (\pi(0), \pi(1), \pi(2)) \begin{pmatrix} .98 & (.02)(.8) & (.02)(.2) \\ 0 & .8 & .2 \\ 1 & 0 & 0 \end{pmatrix}$$

or

$$\begin{aligned} \pi(0) &= .98\pi(0) + \pi(2) \\ \pi(1) &= .016\pi(0) + .8\pi(1) \\ \pi(2) &= .004\pi(0) + .2\pi(1). \end{aligned}$$

Also impose  $\sum_i \pi(i) = 1$  to get  $\pi = \frac{1}{1.1}(1, .08, .02)$ .

c) Let  $X_n$  represent the state of the machine after  $n$  transitions. The long run average of defective parts produced per transition is

$$\lim_{N \rightarrow \infty} \frac{1}{N-1} \sum_{n=1}^{N-1} \{X_n = 2\} = \pi(2)$$

since the only way to get to state 2 is by producing a defective part in the previous transition. The long run average number of parts produced per transition is

$$\lim_{N \rightarrow \infty} \frac{1}{N} \sum_{n=0}^{N-1} \{X_n \in \{0, 1\}\} = \pi(0) + \pi(1)$$

because we don't produce a part in the repair state. Consequently the long run proportion of defective parts is the limit as  $N$  tends to infinity of the ratio of the number of defective parts produced in  $N$  transitions divided by the total number of parts produced in  $N$  transitions; i.e.

$$\begin{aligned} & \lim_{N \rightarrow \infty} \frac{\sum_{n=1}^{N-1} \{X_n = 2\}}{\sum_{n=0}^{N-1} \{X_n \in \{0, 1\}\}} \\ &= \lim_{N \rightarrow \infty} \frac{\sum_{n=1}^{N-1} \{X_n = 2\}/N}{\sum_{n=0}^{N-1} \{X_n \in \{0, 1\}\}/N} \\ &= \frac{\pi(2)}{\pi(0) + \pi(1)} = \frac{.02/1.1}{1.08/1.1} \end{aligned}$$

d) In  $N$  transitions the time elapsed is

$$B(N) = \left( \sum_{0=1}^{N-1} [45 \cdot \{X_n \in \{0, 1\} + 360 \cdot \{X_n = 2\}] \right) / 3600 \text{ hours}$$

During this time the number of nondefectives drilled is

$$A(N) = \sum_{n=1}^{N-1} [\chi\{X_n = 0, X_{n+1} \neq 2\} + \chi\{X_n = 1, X_{n+1} \neq 2\}].$$

The number of nondefectives produced per hour over this period is  $A(N)/B(N) = (A(N)/N)/(B(N)/N)$ . As  $N \rightarrow \infty$ ,

$$\lim_{N \rightarrow \infty} \frac{B(N)}{N} = [45(\pi(0) + \pi(1)) + 360\pi(2)] / 3600$$

and

$$\lim_{N \rightarrow \infty} \frac{A(N)}{N} = [(\pi(0)K_{00} + \pi(0)K_{01}) + (\pi(1)K_{10} + \pi(1)K_{11})].$$

Hence the long rate of nondefectives produced per hour is

$$[(\pi(0)K_{00} + \pi(0)K_{01}) + (\pi(1)K_{10} + \pi(1)K_{11})] / ([45(\pi(0) + \pi(1)) + 360\pi(2)] / 3600).$$

**5.25:** To show the Markov property consider  $a_1, \dots, a_{n-1}$  such that  $a_k > 0$  for all  $k$  and  $a_1 + a_2 + \dots + a_{n-1} + x = t$  where  $x \geq 0$ . If the age at time  $t - 1$  is  $x$  then at time  $t$  either the age increases by 1 or the age drops to 0. The probability of these transitions are respectively

$$\begin{aligned} & P(Z(t) = x | Z(t-1) = x-1, \dots, Z(t-x) = 0, Z(t-x-1) = a_1 - 1 \\ & \quad \dots, Z(t-x-a_{n-1}) = 0, \dots, Z(0) = 0) \\ &= \frac{P(Z(t) = x, Z(t-1) = x-1, \dots, Z(t-x) = 0, \dots, Z(0) = 0)}{P(Z(t-1) = x-1, \dots, Z(t-x) = 0, Z(t-x-1) = a_{n-1} - 1, \dots, Z(0) = 0)} \\ &= \frac{P(X_n > x, X_{n-1} = a_{n-1}, X_{n-2} = a_{n-2}, \dots, X_1 = a_1)}{P(X_n > x-1, X_{n-1} = a_{n-1}, X_{n-2} = a_{n-2}, \dots, X_1 = a_1)} \\ &= \frac{(1 - F(x))f(a_{n-1})f(a_{n-2}) \cdots f(a_1)}{(1 - F(x-1))f(a_{n-1})f(a_{n-2}) \cdots f(a_1)} \\ &= \frac{(1 - F(x))}{(1 - F(x-1))} \end{aligned}$$

and

$$\begin{aligned}
 & P(Z(t) = 0 | Z(t-1) = x-1, \dots, Z(t-x) = 0, Z(t-x-1) = a_1-1, \\
 & \dots, Z(t-x-a_{n-1}) = 0, Z(t-x-a_{n-1}-1) = a_{n-2}-1, \dots, Z(0) = 0) \\
 &= \frac{P(Z(t) = 0, Z(t-1) = x-1, \dots, Z(t-x) = 0, Z(t-x-1) = a_{n-1}-1, \dots)}{P(Z(t-1) = x-1, \dots, Z(t-x) = 0, Z(t-x-1) = a_{n-1}-1, \dots, Z(0) = 0)} \\
 &= \frac{P(X_n = x, X_{n-1} = a_{n-1}, X_{n-2} = a_{n-2}, \dots, X_1 = a_1)}{P(X_n > x-1, X_{n-1} = a_{n-1}, X_{n-2} = a_{n-2}, \dots, X_1 = a_1)} \\
 &= \frac{f(x)f(a_{n-1})f(a_{n-2}) \cdots f(a_1)}{(1-F(x-1))f(a_{n-1})f(a_{n-2}) \cdots f(a_1)} \\
 &= \frac{f(x)}{(1-F(x-1))}.
 \end{aligned}$$

The Markov property is explicitly proved because the distribution at time  $t$  only depends on the state at time  $t-1$  and we have calculated  $K_{x-1,x}$  and  $K_{x-1,0}$  respectively.

Next remark that  $\alpha(x) = 1 - F(x)$  is a stationary distribution by direct calculation. For  $x > 0$ ,

$$\alpha(x) = \alpha(x-1)K_{x-1,x} = (1-F(x-1)) \frac{(1-F(x))}{(1-F(x-1))}.$$

Also

$$\sum_{y=0}^{\infty} \alpha(y)K_{y,0} = \sum_{y=0}^{\infty} (1-F(y)) \frac{f(y)}{(1-F(y))} = 1.$$

Finally we remember that

$$\sum_{y=0}^{\infty} \alpha(y) = \sum_{y=0}^{\infty} (1-F(y)) = \mu_X$$

so  $\pi(x) = \frac{1-F(x)}{\mu}$  defines a stationary probability distribution.

### 9.8.6 Solutions to Selected Exercises in Chapter 6

**6.2:** If  $EX_n^{1+\delta} < B$  for all  $n$  then

$$B \geq E(X_n^{1+\delta} \chi\{X_n > x\}) \geq E(x^{1+\delta} \chi\{X_n > x\}) \geq x^{1+\delta}(1 - F_n(x))$$

for all  $x$  and all  $n$ . Hence,  $\sup_n (1 - F_n(x)) \leq x^{-(1+\delta)} \wedge 1$ .  $H[x] = x^{-(1+\delta)} \wedge 1$  is clearly summable.

**6.8:** There is a renewal every time the elevator returns to the ground floor G. The long run average time spent moving from G to the second floor is

$$\frac{\alpha}{\mu} = \frac{\text{mean time going from G to 2 per cycle}}{\text{expected duration of a cycle}}.$$

We go from G to 2 at most once per cycle with probability  $1/2$  and the time spent is  $3 \cdot 2$  so the denominator is  $3 \cdot 2/2 = 3$  minutes. To calculate the length of a cycle define  $m(x)$  to be the mean time to return to G starting from position  $x \in \{G, 1, 2\}$ . Using the Markov property

$$\begin{aligned} m(G) &= 1 + \frac{1}{2}(3 + m(1)) + \frac{1}{2}(6 + m(2)) \\ m(1) &= 1 + \frac{3}{4}(3 + 0) + \frac{1}{4}(3 + m(2)) \\ m(2) &= 1 + \frac{4}{5}(6 + 0) + \frac{1}{5}(3 + m(1)) \end{aligned}$$

Solving we get  $m(1) = 112/19$ ,  $m(2) = 608/95$  and

$$m(G) = \frac{11}{2} + \frac{1}{2} \frac{112}{19} + \frac{1}{2} \frac{608}{95}.$$

This gives the denominator  $\mu = m(G)$ .

**6.11:**

a) When a taxi is replaced we start a new cycle. Hence the total cost  $T(t)$  incurred until time  $t$  is a renewal reward process. Therefore,

$$\lim_{t \rightarrow \infty} \frac{T(t)}{t} = \frac{\text{expected cost per cycle}}{\text{expected duration of a cycle}}.$$

The p.m.f. of  $T$  is

$$f_T(t) = \frac{21}{20} \frac{1}{(t-1)t}, \quad t = 2, 3, \dots, 21.$$

Using this, the expected duration of a cycle with replacement at  $p$  months is

$$\sum_{t=2}^p t \frac{21}{20} \frac{1}{(t-1)t} + p \left( \frac{21}{20} - \frac{p}{20} \right).$$

The expected cost per cycle is

$$30000 - \left(1 - \frac{21}{20} \left(1 - \frac{1}{p}\right)\right) ED = 30000 - \left(\frac{21}{20} - \frac{p}{20}\right) 10000.$$

Hence,

$$\lim_{t \rightarrow \infty} \frac{T(t)}{t} = \frac{30000 - \left(\frac{21}{20} - \frac{p}{20}\right) 1000}{\sum_{t=2}^p t \frac{21}{20} \frac{1}{(t-1)t} + p \left(\frac{21}{20} - \frac{p}{20}\right)}.$$

b) The test replacement period occurs when the above fraction achieves a minimum. The best way to find the minimum is to simply calculate the above expression for  $p = 2, 3, \dots, 21$ .

c) For large  $t$  the age of a taxi  $Z(t)$  has a limiting density  $f_Z(s) = (1 - F_p(s))/\mu_p$  for  $0 \leq s \leq 14$  where  $F_p$  is the truncated distribution

$$F_p(t) = \begin{cases} 0 & t < 1 \\ \frac{21}{20}(1 - \frac{1}{t}) & 1 \leq t < 14 \\ 1 & t \geq 14. \end{cases}$$

and  $F_p$  has mean  $\mu_p$ . Hence,

$$f_Z(s) = \begin{cases} \frac{1}{\mu} & t = 0 \\ \frac{1}{\mu}(\frac{21}{20}\frac{1}{s} - \frac{1}{20}) & 1 \leq t < 14 \\ 0 & t \geq 14. \end{cases}$$

If we purchase one of these taxis it will have an excess lifetime with a density on  $[0, 21 - 14]$  given by

$$\begin{aligned} f_Y(x) &= \sum_{s=0}^p f_{T|Z(t)}(s+x|s)f_{Z(t)}(s) \\ &= \sum_{s=0}^p \frac{f_T(s+x)}{(1 - F_T(s))} f_{Z(t)}(s) \end{aligned}$$

since the conditional density at  $s+x$  of the lifetime  $T$  given the age at time  $t$  is  $s$  is  $f_T(s+x)/(1 - F_T(s))$ .

### 6.18:

- a) All jobs taken together form an  $M|M|1$  queue. Jobs arrive at the rate of 30 jobs per hour so  $\lambda = .5$  jobs per minute while jobs are served at a rate of 60 jobs per hour or  $\mu = 1$  per minute. Hence the utilization  $\rho = 1/2$ .
- b) The mean of an  $M|M|1$  queue is  $L = \rho/(1 - \rho) = 1$
- c) The proportion of time the server is idle is  $1 - \rho = 1/2$ .
- d) By Little's law  $L = \lambda W$  where  $W$  is the system time of a customer and  $\lambda = 1/2$  is the arrival rate in customers per hour. Hence,  $W = L/\lambda = 2$  minutes.
- e) The high priority jobs don't even notice the low priority jobs so they form an  $M|M|1$  queue with arrival rate  $\lambda_H = 1/6$  per minute and service rate of 1 per minute. Hence the utilization for high priority jobs is  $\rho_H = 1/6$ . The mean of an  $M|M|1$  queue is  $L_H = \rho_H/(1 - \rho_H) = 1/5$  customers.
- f) The utilization  $\rho_H = 1/6$  is the proportion of time spent on high priority customers.
- g) Again use Little's formula so  $W_H = L_H/\lambda_H = (1/5)/(1/6)$  i.e. 1.2 minutes.
- h) The waiting time is the system time minus the mean service time. Hence the expected waiting time is  $W_H - 1$  minutes; i.e. 0.2 minutes.
- i) The difference between the global mean and the high priority mean is  $L_\ell = 1 - .2 = .8$  low priority customers.
- j) The difference between the global utilization and the high priority utilization is  $\rho - \rho_\ell = .5 - 1/6$  which is the proportion of time spent on low priority jobs.

k) The low priority jobs do not form an  $M|M|1$  queue. Nevertheless Little's law applies. Let  $W_L$  represent the mean system time of low priority customers. System time is generated by low priority customers at a rate  $\frac{20}{60} \cdot W_L$  minutes of system time per minute and by high priority customers at rate  $\frac{10}{60} \cdot W_H = \frac{10}{60} \cdot 1.2 = .2$ . The work done by the system in one minute is the queue size; i.e. 1 from b). Hence,  $\frac{20}{60}W_L + .2 = 1$  so  $W_L = .04$  hours or 2.4 minutes.

l) Again the queueing time of low priority customers is the system time minus the service time; that is  $2.4 - 1.0$  minutes.

### 9.8.7 Solutions to Selected Exercises in Chapter 7

#### 7.3:

a) Consider

$$\begin{aligned} P(t)P(s) &= \frac{1}{7} \begin{pmatrix} 4 + 3e^{-7t} & 3 - 3e^{-7t} \\ 4 - 4e^{-7t} & 3 + 4e^{-7t} \end{pmatrix} \frac{1}{7} \begin{pmatrix} 4 + 3e^{-7s} & 3 - 3e^{-7s} \\ 4 - 4e^{-7s} & 3 + 4e^{-7s} \end{pmatrix} \\ &= \frac{1}{7} \begin{pmatrix} 4 + 3e^{-7(t+s)} & 3 - 3e^{-7(t+s)} \\ 4 - 4e^{-7(t+s)} & 3 + 4e^{-7(t+s)} \end{pmatrix} = P(t+s) \end{aligned}$$

after matrix multiplication and simplification. This gives the semigroup property. The further property that  $\lim_{t \rightarrow 0} P(t) = I$  follows by inspection.

b)

$$G = \frac{d}{dt} P(t)|_{t=0} = \frac{1}{7} \begin{pmatrix} -21 & 21 \\ 28 & -28 \end{pmatrix}.$$

c) If the two states are 0 and 1 then the holding time in state 0 is exponential with a mean of  $1/21$  followed by a transition to state 1. The holding time in state 1 is exponential with a mean of  $1/28$ . This is followed by a transition back to state 0.

d) Solving

$$(\pi(0), \pi(1)) \begin{pmatrix} -21 & 21 \\ 28 & -28 \end{pmatrix} = 0$$

gives  $(\pi(0), \pi(1)) = (4/7, 3/7)$ . This is naturally the limiting value of the rows of  $P(t)$ .

#### 7.10:

a) There are 4 possible states. State 0 represent the state when both operators are idle, state 1 means the machine shop is busy but the subcontractor is idle, state 2 means both the machine shop and the subcontractor are busy while state 3 means the machine shop is idle but the contractor is busy. The generator gives the rate of

transition (with time measured in days) between the states:

$$G = \begin{pmatrix} -3/7 & 3/7 & 0 & 0 \\ 1/2 & -13/14 & 3/7 & 0 \\ 0 & 1/5 & -7/10 & 1/2 \\ 1/5 & 0 & 3/7 & -22/35. \end{pmatrix}$$

The first row describes the arrival of a job at rate  $3/7$  jobs per day when both shops are idle. The second row describes transitions when the state is 1. With rate  $1/2$  jobs per day the shop finishes the job and the state becomes 0 but a new job arrives with rate  $3/7$  causing a transition to state 2. The third row describes transitions when both shops are busy. Either the subcontractor finishes its job at rate  $1/5$  jobs per day causing a jump to state 1 or the shop finishes its job at rate  $1/2$  jobs per day causing a jump to state 3. The fourth row describes the transitions when only the subcontractor is busy. Either the subcontractor finishes its job at rate  $1/5$  jobs per day causing a jump to state 0 or a new job arrives with rate  $3/7$  causing a jump to state 2.

b) We solve  $\pi G = 0$ .

c)  $\pi(2) + \pi(3)$ .

**7.12:** Denote the queue at the junior accountant by 1 and the queue at the senior accountant by 2. We consider three classes of jobs. The complicated cases are called class a and they arrive in the junior accountants in-box at a rate of  $\lambda^a(1) = 6$  per hour. After processing these class a jobs enter the senior accountants in-box at a rate  $\lambda^a(2) = 6$ . Simple cases are called class b jobs and they arrive in the junior accountants in-box at a rate of  $\lambda^b(1) = 4$  per hour. After classification class b job become class c jobs which enter the junior accountants in-box at a rate of  $\lambda^c(1) = 4$ .

The total flows into queues 1 and 2 are

$$\lambda(1) = \lambda^a(1) + \lambda^b(1) + \lambda^c(1) = 14$$

$$\lambda(2) = \lambda^a(2) = 6.$$

The loads on queue 1 and 2 are respectively  $\rho_1 = 14/20$  and  $\rho_2 = 6/15$ . This Kelly network has a steady state  $\pi$ . The probability the first queue has 3 forms for classification as well as two simple files is

$$(1 - \rho_1)\rho_1^5 \binom{5}{3} \left( \frac{\lambda^a(1) + \lambda^b(1)}{\lambda(1)} \right)^3 \left( \frac{\lambda^c(1)}{\lambda(1)} \right)^2.$$

The probability the second queue has two complicated forms to process is  $(1 - \rho_2)\rho_2^2$ . The probability we see is the product of these two marginals.

If the service rate depends on the class of customer then the system is no longer a Kelly network and all bets are off. It's appalling how easily one can go from a simple problem to an intractable one.

### 9.8.8 Solutions to Selected Exercises in Chapter 8

#### 8.4:

a) Let  $W_\alpha(x)$  be the minimal discounted cost so the Bellman optimality equation gives

$$\begin{aligned} W_\alpha(0) &= \min\left\{1 + \frac{1}{2}(K_{00}(0)W_\alpha(0) + K_{01}(0)W_\alpha(1)), \right. \\ &\quad \left. 1.5 + \frac{1}{2}(K_{00}(1)W_\alpha(0) + K_{01}(1)W_\alpha(1))\right\} \\ W_\alpha(1) &= \min\left\{2 + \frac{1}{2}(K_{10}(0)W_\alpha(0) + K_{11}(0)W_\alpha(1)), \right. \\ &\quad \left. 3 + \frac{1}{2}(K_{10}(1)W_\alpha(0) + K_{11}(1)W_\alpha(1))\right\} \end{aligned}$$

or

$$W_\alpha(0) = \min\left\{1 + \frac{1}{2}\left(\frac{1}{2}W_\alpha(0) + \frac{1}{2}W_\alpha(1)\right), 1.5 + \frac{1}{2}\left(\frac{1}{4}W_\alpha(0) + \frac{3}{4}W_\alpha(1)\right)\right\} \quad (9.2)$$

$$W_\alpha(1) = \min\left\{2 + \frac{1}{2}\left(\frac{1}{2}W_\alpha(0) + \frac{1}{2}W_\alpha(1)\right), 3 + \frac{1}{2}\left(\frac{3}{8}W_\alpha(0) + \frac{5}{8}W_\alpha(1)\right)\right\} \quad (9.3)$$

There are in fact four possible equations and we must try them all. However it looks like a good idea to avoid state one so first try the equations corresponding to always using action 0. This gives

$$W_\alpha(0) = 1 + \frac{1}{2}\left(\frac{1}{2}W_\alpha(0) + \frac{1}{2}W_\alpha(1)\right)$$

$$W_\alpha(1) = 2 + \frac{1}{2}\left(\frac{1}{2}W_\alpha(0) + \frac{1}{2}W_\alpha(1)\right).$$

The solution is  $W_\alpha(0) = 5/2$  and  $W_\alpha(1) = 7/2$ . Substitution shows these values satisfy (9.2). Since the optimal return function is unique we conclude the optimal policy is to always use action 0 and the minimum expected cost starting in state 0 is  $5/2$ .

b) Let  $A$  be the minimum long run average return. We must find  $r(1)$  (assuming without loss of generality (wolog) that  $r(0) = 0$ ) as in Theorem 8.15. The optimality equations are

$$A + r(0) = \min\{1 + (K_{00}(0)r(0) + K_{01}(0)r(1)), 1.5 + (K_{00}(1)r(0) + K_{01}(1)r(1))\}$$

$$A + r(1) = \min\{2 + (K_{10}(0)r(0) + K_{11}(0)r(1)), 3 + (K_{10}(1)r(0) + K_{11}(1)r(1))\}$$

or

$$A + r(0) = \min\left\{1 + \left(\frac{1}{2}r(0) + \frac{1}{2}r(1)\right), 1.5 + \left(\frac{1}{4}r(0) + \frac{3}{4}r(1)\right)\right\} \quad (9.4)$$

$$A + r(1) = \min\left\{2 + \left(\frac{1}{2}r(0) + \frac{1}{2}r(1)\right), 3 + \left(\frac{3}{8}r(0) + \frac{5}{8}r(1)\right)\right\}.$$



Again we have four possible equations but it still seems like a good idea to avoid state 1 so try action 0 in all states. The corresponding equation is

$$\begin{aligned} A + r(0) &= 1 + \left(\frac{1}{2}r(0) + \frac{1}{2}r(1)\right) \\ A + r(1) &= 2 + \left(\frac{1}{2}r(0) + \frac{1}{2}r(1)\right) \end{aligned}$$

and the solution is  $A = 3/2$ ,  $r(1) = 1$  and  $r(0) = 0$ . Substitution shows this solution solves (9.4). Clearly  $r(X_N)/N \rightarrow 0$  so we conclude the long run average return is  $3/2$  and we should always use policy 0.

Notice that we can calculate the long run average return from kernel  $K(0)$  using Theorem 5.18. The steady state of  $K(0)$  is  $\pi = (1/2, 1/2)$  so the long run average is  $1 \cdot \pi(0) + 2 \cdot \pi(1) = 3/2$  which is  $A$ .

**8.6:**

a) The age of the bus in months represents the state so  $S = \{0, 1, 2, \dots\}$ . The action is to decide at the beginning of the month to repair the bus or not so  $\mathcal{A} = \{0, 1\}$  where 1 denotes the decision to repair the bus and 0 not to repair.

b) Let  $p(x) = \min\{1, .1 + 0.05x\}$  denote the probability the bus breaks if the age of the bus is  $x$  at the start of the month. Hence, for all  $x \in S$ ,

$$K_{x,0}(1) = 1, K_{x,0}(0) = p(x) \text{ and } K_{x,x+1}(0) = 1 - p(x).$$

c) Let  $\alpha = 1/1.005$  Let  $V(x)$  denote the minimum expected cost so  $V(x) = \min\{f(x,0), f(x,1)\}$  where

$$f(x,0) = \alpha p(x) \cdot 7000 + \alpha(p(x)V(0) + (1-p(x))V(x+1)) \text{ and } f(x,1) = 5000 + \alpha V(0).$$

$f(x,1)$  is the cost if we repair immediately and then act optimally while  $f(x,0)$  is the cost of continuing without repair and then acting optimally in future.

d) Note that for  $x \geq 18$ ,  $p(x) = 1$  so for  $x \geq 1$

$$V(x) = \min\{5000 + \alpha V(0), 7000 \cdot \alpha + \alpha V(0)\};$$

that is  $V(x) = 5000 + \alpha V(0) = f(x,1)$  and the optimal policy is to do a repair immediately. Clearly  $f(x,0) \leq 5000 + \alpha V(0)$  so it we can show  $f(x,0)$  is increasing we know the optimal policy is to repair as soon as  $f(x,0) > 5000 + \alpha V(0)$ .

We first show  $V(x)$  is increasing. Consider any positive, nondecreasing function  $u$  and define the operators

$$T_0 u(x) = \alpha p(x) \cdot 7000 + \alpha(p(x)u(0) + (1-p(x))u(x+1)) \text{ and } T_1 u(x) = 5000 + \alpha V(0).$$

$T_1 u(x)$  is obviously increasing.

$$\begin{aligned} T_0 u(x+1) - T_0 u(x) &= \alpha((p(x+1) - p(x))(7000 + u(0)) + (u(x+2) - u(x+1))) \\ &\quad - (p(x+1)u(x+2) - p(x)u(x+1))) \\ &\geq \alpha(p(x+1) - p(x))(7000 + u(0)) \geq 0 \end{aligned}$$

since

$$(p(x+1)u(x+2) - p(x)u(x+1)) \leq p(x)(u(x+2) - u(x+1)) \leq (u(x+2) - u(x+1)).$$

This proves  $T_0 u(x)$  is increasing in  $x$ . So is the function  $Tu(x) = \min\{T_0 u(x), T_1 u(x)\}$  since it is the minimum of two increasing functions. If we start out with  $u = 0$  then  $T^n u(x) \rightarrow V(x)$  and  $T^n u$  is an increasing function. Since the limit of increasing functions is increasing it follows that  $V(x)$  is increasing.

Finally,  $f(x, 0) = T_0 V(x)$ . By the above  $V(x)$  is increasing in  $x$  and then so is  $T_0 V(x)$ . We conclude  $f(x, 0)$  is indeed increasing and we have proved the (intuitively obvious) optimal policy is to repair as soon as the age reaches some value  $x_0$  such that  $f(x_0, 0) > 5000 + \alpha V(0)$ .

**8.19:** We observe the number of items until the next defective. Hence we observe a sequence of i.i.d. geometric random variables  $X_n$  with p.m.f.  $f_0(x) = 0.01(1 - 0.01)^{x-1}$ . After the change point the time between defectives is a geometric random variable with  $f_1(x) = 0.05(1 - 0.05)^{x-1}$ . The log likelihood is

$$\begin{aligned} \log(\ell(x)) &= \log(0.05(1 - 0.05)^{x-1}/0.01(1 - 0.01)^{x-1}) \\ &= \log\left(\frac{(0.05)(0.99)}{(0.95)(0.99)}\right) + x \log\left(\frac{0.95}{0.99}\right) \\ &= -\log\left(\frac{0.95}{0.99}\right) \left(\log\left(\frac{(0.05)(0.99)}{(0.95)(0.99)}\right)/\log\left(\frac{0.95}{0.99}\right) - x\right) \\ &= 0.0179(71.39 - x) \end{aligned}$$

Define  $V_n = 71.39 - X_n$ . This means that, up to a constant factor, the Cusum is defined by  $C_0 = 0, C_n = \max\{C_{n-1} + V_n, 0\}$  and Page's stopping time is defined as the first time  $C_n \geq H$ . This is equivalent to stopping if  $D_n \leq -H$  where  $D_n = -C_n$  so  $D_n$  satisfies

$$D_0 = 0, D_n = \min\{D_{n-1} - V_n, 0\} = \min\{D_{n-1} + X_n - 71.39, 0\}.$$

Such a control chart plotted below the axis is typically used for testing if the mean of normally distributed quality measurements decreases from the nominal value  $\mu_0$  to  $\mu_1$ . In fact it is common practice to plot two charts in one to detect an increase or a decrease in the process mean.

To find  $H$  one could use Markov chain methods as we did for normal random variables (except here discretization is not necessary). The simplest thing would be to experiment using simulation.

The Cumulative Standard Normal Distribution can be generated using the following *Mathematica* program:

```
f[w_]=(E^(-u^2/2))/Sqrt[2 Pi];
normal=Table[PaddedForm[NIntegrate[%,{u,-Infinity,i+j}],
  {4,4}],{j,0,3,0.1},{i,0,0.09,0.01}];
output=TableForm[normal, TableSpacing -> {0,2},
TableHeadings ->
{{"0.0","0.1","0.2","0.3","0.4","0.5","0.6","0.7","0.8",
  "0.9","1.0","1.1","1.2","1.3","1.4","1.5","1.6","1.7",
  "1.8","1.9","2.0","2.1","2.2","2.3","2.4","2.5","2.6",
  "2.7","2.8","2.9","3.0"}},
{" 0.00"," 0.01"," 0.02"," 0.03"," 0.04"," 0.05",
" 0.06"," 0.07"," 0.08"," 0.09"}]}
```

	0.00	0.01	0.02	0.03	0.04	0.05	0.06	0.07	0.08	0.09
0.0	0.5000	0.5040	0.5080	0.5120	0.5160	0.5199	0.5239	0.5279	0.5319	0.5359
0.1	0.5398	0.5438	0.5478	0.5517	0.5557	0.5596	0.5636	0.5675	0.5714	0.5753
0.2	0.5793	0.5832	0.5871	0.5910	0.5948	0.5987	0.6026	0.6064	0.6103	0.6141
0.3	0.6179	0.6217	0.6255	0.6293	0.6331	0.6368	0.6406	0.6443	0.6480	0.6517
0.4	0.6554	0.6591	0.6628	0.6664	0.6700	0.6736	0.6772	0.6808	0.6844	0.6879
0.5	0.6915	0.6950	0.6985	0.7019	0.7054	0.7088	0.7123	0.7157	0.7190	0.7224
0.6	0.7257	0.7291	0.7324	0.7357	0.7389	0.7422	0.7454	0.7486	0.7517	0.7549
0.7	0.7580	0.7611	0.7642	0.7673	0.7704	0.7734	0.7764	0.7794	0.7823	0.7852
0.8	0.7881	0.7910	0.7939	0.7967	0.7995	0.8023	0.8051	0.8078	0.8106	0.8133
0.9	0.8159	0.8186	0.8212	0.8238	0.8264	0.8289	0.8315	0.8340	0.8365	0.8389
1.0	0.8413	0.8438	0.8461	0.8485	0.8508	0.8531	0.8554	0.8577	0.8599	0.8621
1.1	0.8643	0.8665	0.8686	0.8708	0.8729	0.8749	0.8770	0.8790	0.8810	0.8830
1.2	0.8849	0.8869	0.8888	0.8907	0.8925	0.8944	0.8962	0.8980	0.8997	0.9015
1.3	0.9032	0.9049	0.9065	0.9082	0.9099	0.9115	0.9131	0.9147	0.9162	0.9177
1.4	0.9192	0.9207	0.9222	0.9236	0.9251	0.9265	0.9279	0.9292	0.9306	0.9319
1.5	0.9332	0.9345	0.9357	0.9370	0.9382	0.9394	0.9406	0.9418	0.9429	0.9441
1.6	0.9452	0.9463	0.9474	0.9484	0.9495	0.9505	0.9515	0.9525	0.9535	0.9545
1.7	0.9554	0.9564	0.9573	0.9582	0.9591	0.9599	0.9608	0.9616	0.9625	0.9633
1.8	0.9641	0.9649	0.9656	0.9664	0.9671	0.9678	0.9686	0.9693	0.9699	0.9706
1.9	0.9713	0.9719	0.9726	0.9732	0.9738	0.9744	0.9750	0.9756	0.9761	0.9767
2.0	0.9772	0.9778	0.9783	0.9788	0.9793	0.9798	0.9803	0.9808	0.9812	0.9817
2.1	0.9821	0.9826	0.9830	0.9834	0.9838	0.9842	0.9846	0.9850	0.9854	0.9857
2.2	0.9861	0.9864	0.9868	0.9871	0.9875	0.9878	0.9881	0.9884	0.9887	0.9890
2.3	0.9893	0.9896	0.9898	0.9901	0.9904	0.9906	0.9909	0.9911	0.9913	0.9916
2.4	0.9918	0.9920	0.9922	0.9925	0.9927	0.9929	0.9931	0.9932	0.9934	0.9936
2.5	0.9938	0.9940	0.9941	0.9943	0.9945	0.9946	0.9948	0.9949	0.9951	0.9952
2.6	0.9953	0.9955	0.9956	0.9957	0.9959	0.9960	0.9961	0.9962	0.9963	0.9964
2.7	0.9965	0.9966	0.9967	0.9968	0.9969	0.9970	0.9971	0.9972	0.9973	0.9974
2.8	0.9974	0.9975	0.9976	0.9977	0.9977	0.9978	0.9979	0.9979	0.9980	0.9981
2.9	0.9981	0.9982	0.9982	0.9983	0.9984	0.9984	0.9985	0.9985	0.9986	0.9986
3.0	0.9987	0.9987	0.9987	0.9988	0.9988	0.9989	0.9989	0.9989	0.9990	0.9990

This page intentionally left blank

# Index

- $M/G/\infty$  queue, 107
- $R$ -chart, 89
- $\sigma$ -algebra  $\mathcal{F}_X$  generated by a random variable  $X$ , 57
- $\sigma$ -Algebras, 34
- $\sigma$ -additivity, 35
  
- accessible, 135
- action, 271
- AFI, 86
- age, 185
- Alternating renewal processes, 186
- AOQL, 14, 86
- aperiodic, 141
- AQL, 7
- asynchronous transfer mode, 1
- ATM, 1
- ATM networks, 32
- ATM switch, 2
- atomic, 34, 35
  
- backward induction, 278
- Banach space, 324
- BASTA property, 145
- Bellman optimality equation, 277
- Bernoulli, 71
- Bernoulli Part, 214
- Bernoulli Part Decomposition, 214
- Bernoulli Point Processes, 100
- Binomial, 72
- birth and death process, 242
- Borel-Cantelli Lemma, 321
- Bramson Networks, 259
- Buffer control, 275
- burst, 129
- Bursty ATM traffic, 128
  
- calls in progress, 101
- cell loss rate, 139
- cells, 1
- central limit theorem, 78
- change point, 308
- Chapman-Kolmogorov, 133
- Chebyshev, 18
- Chebyshev's Inequality, 47
- Communication classes, 135
- commute, 326
- complete metric space, 325
- Concavity, 322
- conditional probability, 48
- conditional probability mass function, 49
- conditional probability measure, 50
- Contending processors, 231
- Continuous sampling inspection by attribute, 86
- Continuous Time Decision Problems, 295
- continuous uniform distribution, 77
- contraction, 287, 325
- Control charts, 88
- controller, 271
- converges in distribution as, 77
- Convexity, 322
- coupled, 203
- Cusum, 150
- Cusum procedure, 308
  
- decision theory, 271
- delayed renewal process, 183
- density, 79
- discounted costs, 286
- discrete (nonhomogeneous) Poisson process, 115
- discrete random variables, 39

- distribution function, 41
- DOD, 7
- Dominated Convergence, 321
- Drunkard's walk, 62
- Dynkin's Formula, 60
- equilibrium distribution for the
  - homogeneous renewal process, 194
- equiprobable, 36
- equivalence class, 327
- equivalence relation, 327
- Erlang- $m$  distribution, 118
- events, 34
- excess, 185
- expected value, 45
- exponential distribution, 77
- Fatou's Lemma, 320
- fictional jumps, 263
- fixed point, 325
- Foster's Criterion, 175
- Fubini's Theorem, 322
- generator, 231
- geometric, 75
- greatest common divisor, 327
- histogram, 17
- hitting time, 152
- homogeneous Markov chain, 127
- homogeneous Poisson process, 105
- independence, 52
- independent events, 52
- independent random variables, 52
- indicator function, 49
- infinite horizon, 286
- initial distribution, 128
- interarrival times, 99
- IP router, 2
- irreducible, 136, 237
- Jackson network, 250
- joint distribution function, 43
- joint probability mass function, 42
- Kelly Networks, 254
- Kelly's Lemma, 246
- Kolmogorov Extension Theorem, 59
- Kolmogorov's backward, 235
- Kolmogorov's forward, 235
- Law of large numbers, 85
- Law of the Unconscious Statistician, 80
- Lebesgue integral, 55
- linearity, 45
- Little's Theorem, 200
- load, 243
- long run average expected cost, 290
- marginal p.m.f., 43
- Markov process, 229
- Markov property, 128
- Markov's Inequality, 47
- Markovian policies, 272
- memorylessness, 75
- memorylessness property, 102
- MIL-STD-105D, 7
- moment generating function, 82
- Monotone Convergence, 55, 320
- monotonicity, 45
- multiclass queues, 247
- nanosecond precision, 100
- No-shows, 79
- nonhomogeneous Poisson process, 120
- Nonparametric control charts, 157
- normal random variable, 79
- Norms, 324
- null recurrent, 167
- OC curve, 74
- on and off-target run lengths, 155
- optimal cost, 276
- Optimal parking, 273
- Optimal Stopping, 298
- order statistic, 105
- p.m.f., 41
- packets, 1
- Page's procedure, 309
- Palm process, 196
- Pascal, 76
- peak rate, 129
- period, 141
- Poisson, 76
- policy, 271
- Pollaczek-Khinchin equation, 143
- positive recurrent, 167
- probability generating function, 82

- probability mass function, 41
- probability measure, 35
- probability transition kernel, 128
- process, 171
- product form, 251
- pseudo-random numbers, 78
  
- random variable, 38
- recurrent, 167
- reference or anchor value, 151
- regenerative process, 185
- rejection method, 81
- renewal process, 183
- renewal reward process, 189
- reversible chain, 148
  
- sample point, 31
- sample space, 31
- sampling inspection, 73
- Scheffé's Theorem, 321
- Schwarz inequality, 323
- semi-group, 235
- Shewhart  $\bar{x}$ -chart, 89
- simple point process, 183
- simple random variable, 44
- spread-out, 217
- stable, 136
- standard deviation, 47
- standard normal distribution, 78
- stationary, 136
- stationary point processes, 192
- statistical multiplexing, 5
- Stirling, 225
- stochastic integral, 119
- stochastic process, 32, 40
- stopping time, 41, 165
- Strong Markov Property, 170
- system time, 145
  
- TCP/IP, 1
- time reversal, 147, 244
- time to the horizon, 271
- total variation, 113
- transient, 167
- transition, 233
  
- unconscious statistician, 46
- uniform integrability, 320
- uniformization, 263
- uniformized Markov chain, 239
  
- uniformly distributed on  $[0, 1]$ , 77
- variance, 47
  
- Wald's Lemma, 61
- watched process, 171
- worst case, 309
- worst case sense, 308
  
- z-transform, 82