

G. Xudayberganov, A. Vorisov,
X. Mansurov, B. Shoimqulov

MATEMATIK ANALIZDAN MA'RUZALAR

II

**O‘ZBEKISTON RESPUBLIKASI OLIY VA
O‘RTA MAXSUS TA‘LIM VAZIRLIGI**

*G. Xudayberganov, A.K. Vorisov,
X.T. Mansurov, B.A. Shoimqulov*

MATEMATIK ANALIZDAN MA‘RUZALAR

II

*5460100—«Matematika», 5440200—«Mexanika» bakalavr
yo‘nalishidagi talabalar uchun o‘quv qo‘llanma*

«Voris-nashriyot»
Toshkent—2010

22.1
M31

Taqrizchilar:

fizika-matematika fanlari doktori, professor
R.R. Ashurov,

fizika-matematika fanlari doktori, professor
R.N. G'anixo'jayev.

Qo'lingizdagi o'quv qo'llanma «Matematik analizdan ma'ruzalar» (1- qism) kitobning davomi bo'lib, dastur materiallari 6 bob, 39 ta ma'ruzaga ajratib bayon qilingan. Bu ikkinchi qism ko'p o'zgaruvchili funksiya, uning limiti, uzluksizligi, differensial va integral hisobi, funksional ketma-ketlik, funksional qatorlar mavzularini o'z ichiga oladi.

Mazkur o'quv qo'llanma matematika va mexanika bakalavr yo'nalishlarida ta'lim olayotgan talabalarga mo'ljallangan bo'lsa-da, undan shuningdek, matematika kengroq o'qitiladigan oliy ta'lim muassasalari talabalari ham foydalanishlari mumkin.



SO‘ZBOSHI

Ushbu o‘quv qo‘llanma «Matematik analizdan ma‘ruzalar» (1- qism) kitobining davomi bo‘lib, dastur materiallari 6 bob, 39 ta ma‘ruzaga ajratib bayon qilingan. Bu ikkinchi qism ko‘p o‘zgaruvchili funksiya, uning limiti, uzluksizligi, differensial va integral hisobi, funksional ketma-ketlik, funksional qatorlar mavzularini o‘z ichiga oladi. Qo‘llanmani yozishdagi asosiy tamoyillar 1- qismda yozilgan so‘zboshida keltirilgan bo‘lib, 2- qismni tayyorlashda ham shu tamoyillarga amal qilindi.

Mazkur o‘quv qo‘llanma matematika va mexanika bakalavr yo‘nalishlarida ta‘lim olayotgan talabalarga mo‘ljallangan bo‘lsa-da, undan matematika kengroq o‘qitiladigan oliy ta‘lim muassasalari talabalari ham foydalanishlari mumkin.

Qo‘llanmani tayyorlashda mualliflar Mirzo Ulug‘bek nomidagi O‘zbekiston Milliy universiteti mexanika-matematika fakultetida matematik analiz fanining o‘qitilish jarayonida yig‘ilgan tajribalaridan imkon darajasida foydalanishga harakat qildilar.

Kitob qo‘lyozmasini sinchiklab o‘qib chiqib, uning ilmiy va metodik jihatdan yaxshilanishiga o‘z hissalarini qo‘shganliklari uchun professor R.R. Ashurov, R.N. G‘anixo‘jayevlarga mualliflar minnatdorchilik bildiradilar.

Qo‘llanmaning sifatini yaxshilashga qaratilgan fikr-mulohazalarini bildirgan hamkasblarga ham avvaldan o‘z minnatdorchiligimizni bildiramiz.

Mualliflar.

11- B O B
SONLI QATORLAR (davomi)

53- ma'ruza

Ixtiyoriy hadli qatorlarda yaqinlashish alomatlari

1°. Leybnits alomati. Ushbu

$$\sum_{n=1}^{\infty} (-1)^{n-1} c_n = c_1 - c_2 + c_3 - c_4 + \dots + (-1)^{n-1} c_n + \dots \quad (1)$$

qatorni qaraymiz, bunda $c_n > 0$, ($n = 1, 2, 3, \dots$).

Odatda, bunday qator *hadlarining ishoralari navbat bilan o'zgarib keladigan qator* deyiladi.

Ravshanki, (1) qator ixtiyoriy hadli qatorning bitta holidir.

Masalan, ushbu

$$\sum_{n=1}^{\infty} (-1)^{n-1} \cdot \frac{1}{n} = 1 - \frac{1}{2} + \frac{1}{3} - \frac{1}{4} + \dots + (-1)^{n-1} \frac{1}{n} + \dots$$

qator hadlarining ishoralari navbat bilan o'zgarib keladigan qator bo'ladi.

1- teorema. (Leybnits alomati.) Agar hadlarining ishoralari navbat bilan o'zgarib keladigan (1) qatorda:

1) $c_{n+1} < c_n$, ($n = 1, 2, 3, \dots$);

2) $\lim_{n \rightarrow \infty} c_n = 0$ bo'lsa, u holda (1) qator yaqinlashuvchi bo'ladi.

◀ (1) qatorning dastlabki $2m$ ta ($m \in N$) hadidan iborat qisman yig'indisi

$$S_{2m} = c_1 - c_2 + c_3 - c_4 + \dots + c_{2m-1} - c_{2m}$$

ni olaylik. Unda $S_{2(m+1)}$ uchun

$$S_{2(m+1)} = S_{2m} + (c_{2m+1} - c_{2m+2})$$

bo'lib, $c_{2m+2} < c_{2m+1}$ bo'lganligi sababli (bunda $c_{2m+1} - c_{2m+2} > 0$ bo'ladi)

$$S_{2(m+1)} > S_{2m}, \quad (m = 1, 2, 3, \dots)$$

bo'ladi. Demak, $\{S_{2m}\}$ ketma-ketlik o'suvchi.

Endi S_{2m} yig'indini quyidagicha yozamiz:

$$S_{2m} = c_1 - (c_2 - c_3) - (c_4 - c_5) - \dots - (c_{2m-2} - c_{2m-1}) - c_{2m}.$$

Bu tenglikning o'ng tomonidagi ifodada qatnashgan qavs ichidagi ayirmalarning, shuningdek, c_{2m} ning musbat bo'lishini e'tiborga olib,

$$S_{2m} < c_1$$

bo'lishini topamiz. Demak, $\{S_{2m}\}$ ketma-ketlik yuqoridan chegaralangan.

Monoton ketma-ketlikning limiti haqidagi teorema ko'ra

$$\lim_{m \rightarrow \infty} S_{2m} = S, \quad (S - \text{chekli son}) \quad (2)$$

mavjud.

Endi (1) qatorning dastlabki $2m - 1$ ta ($m \in N$) sondagi hadidan iborat ushbu

$$S_{2m-1} = c_1 - c_2 + c_3 - c_4 + \dots + c_{2m-1}$$

qisman yig'indisini olaylik. Ravshanki,

$$S_{2m-1} = S_{2m} + c_{2m}.$$

Teoremaning $n \rightarrow \infty$ da $c_n \rightarrow 0$ bo'lishi sharti hamda (2) munosabatdan foydalanib topamiz:

$$\lim_{m \rightarrow \infty} S_{2m-1} = \lim_{m \rightarrow \infty} (S_{2m} + c_{2m}) = S.$$

Shunday qilib, berilgan (1) qatorning qisman yig'indilaridan iborat ketma-ketlik chekli limitga ega ekani ko'rsatildi. Demak, (1) qator yaqinlashuvchi. ►

Masalan,
$$1 - \frac{1}{2} + \frac{1}{3} - \frac{1}{4} + \dots + \frac{(-1)^{n-1}}{n} + \dots \quad (3)$$

qator hadlari keltirilgan teoremaning barcha shartlarini qanoatlantiradi. Teorema ko'ra (3) qator yaqinlashuvchi bo'ladi ((3) qatorning yaqinlashuvchanligi va yig'indisi $\ln 2$ ga teng bo'lishi ko'rsatilgan edi).

2°. Dirixle–Abel alomati. Faraz qilaylik,

$$a_1, a_2, a_3, \dots, a_n, \dots$$

$$b_1, b_2, b_3, \dots, b_n, \dots$$

ixtiyoriy haqiqiy sonlar ketma-ketliklari bo'lib,

$$S_n = a_1 + a_2 + \dots + a_n$$

bo'lsin. U holda $\forall n \in N, \forall m \in N$ uchun

$$\sum_{k=n}^{n+m} a_k b_k = \sum_{k=n}^{n+m-1} S_k (b_k - b_{k-1}) + S_{n+m} \cdot b_{n+m} - S_{n-1} b_n \quad (4)$$

munosabat o'rinli bo'ladi.

Odatda, (4) munosabat *Abel ayniyati* deyiladi.

◀ Ravshanki, $a_k = S_k - S_{k-1}$ bo'ladi. U holda $\sum_{k=n}^{n+m} a_k b_k$ yig'indi ushbu

$$\sum_{k=n}^{n+m} a_k b_k = \sum_{k=n}^{n+m} S_k b_k - \sum_{k=n}^{n+m} S_{k-1} b_k \quad (5)$$

ko'rinishga keladi. Bu tenglikning o'ng tomonidagi birinchi qo'shiluvchini quyidagicha:

$$\sum_{k=n}^{n+m} S_k b_k = \sum_{k=n}^{n+m-1} S_k b_k + S_{n+m} b_{n+m}$$

shaklda, ikkinchi qo'shiluvchini esa quyidagicha

$$\sum_{k=n}^{n+m} S_{k-1} b_k = \sum_{k=n-1}^{n+m-1} S_k b_{k+1} = S_{n-1} b_n + \sum_{k=n}^{n+m-1} S_k b_{k+1}$$

shaklda yozib olamiz. Natijada (5) tenglik quyidagicha:

$$\begin{aligned} \sum_{k=n}^{n+m} S_k b_k &= \sum_{k=n}^{n+m-1} S_k b_k + S_{n+m} b_{n+m} - \sum_{k=n}^{n+m-1} S_k b_{k+1} - S_{n-1} b_n = \\ &= \sum_{k=n}^{n+m-1} S_k (b_k - b_{k+1}) - S_{n+m} b_{n+m} - S_{n-1} b_n \end{aligned}$$

bo'ladi. ▶

2- teorema. (Dirixe–Abel alomati.) Aytaylik,

$$\sum_{k=1}^{\infty} a_k b_k = a_1 b_1 + a_2 b_2 + \dots + a_k b_k + \dots \quad (6)$$

qator berilgan bo'lsin. Agar:

1) $\{b_k\}$ ketma-ketlik kamayuvchi va u cheksiz kichik miqdor,

2) $\sum_{k=1}^{\infty} a_k$ qatorning qisman yig'indilari ketma-ketligi chegaralangan

bo'lsa, (6) qator yaqinlashuvchi bo'ladi.

◀ Agar $\sum_{k=1}^{\infty} a_k$ qatorning qisman yig'indisini

$$S_n = a_1 + a_2 + \dots + a_n$$

desak, unda teoremaning shartiga ko'ra, shunday $M > 0$ son topiladiki, barcha $n \in N$ uchun

$$|S_n| \leq M \quad (7)$$

bo'ladi.

Shartga ko'ra $\{b_k\}$ ketma-ketlik kamayuvchi va u cheksiz kichik miqdor. Unda $\forall \varepsilon > 0$ ga ko'ra shunday $n_0 \in N$ topiladiki, $\forall n > n_0$ da

$$0 \leq b_n < \frac{\varepsilon}{2M} \quad (8)$$

bo'ladi. Endi $\sum_{k=n}^{n+m} a_k b_k$ yig'indiga Abel ayniyatini qo'llaymiz:

$$\sum_{k=n}^{n+m} a_k b_k = \sum_{k=n}^{n+m-1} S_k (b_k - b_{k+1}) + S_{n+m} b_{n+m} - S_{n-1} b_n.$$

Natijada

$$\begin{aligned} \left| \sum_{k=n}^{n+m} a_k b_k \right| &\leq \sum_{k=n}^{n+m-1} |S_k (b_k - b_{k+1})| + |S_{n+m} b_{n+m}| + |S_{n-1} b_n| = \\ &= \sum_{k=n}^{n+m-1} |S_k| \cdot (b_k - b_{k+1}) + |S_{n+m}| b_{n+m} + |S_{n-1}| \cdot b_n \end{aligned}$$

bo'ladi.

(7) tengsizlikdan foydalanib topamiz:

$$\left| \sum_{k=n}^{n+m} a_k b_k \right| \leq M \left[\sum_{k=n}^{n+m-1} (b_k - b_{k+1}) + b_{n+m} \right] + M \cdot b_n.$$

Agar

$$\sum_{k=n}^{n+m-1} (b_k - b_{k+1}) + b_{n+m} = (b_n - b_{n+1}) + (b_{n+1} - b_{n+2}) + \dots + (b_{n+m-1} - b_{n+m}) + b_{n+m} = b_n$$

bo'lishini e'tiborga olsak, unda

$$\left| \sum_{k=n}^{n+m} a_k b_k \right| \leq 2M \cdot b_n$$

bo'lib, (8) munosabatga ko'ra

$$\left| \sum_{k=n}^{n+m} a_k b_k \right| < \varepsilon$$

bo'ladi. Bundan Koshi teoremasiga ko'ra $\left| \sum_{k=n}^{n+m} a_k b_k \right| < \varepsilon$ qatorning yaqinlashuvchanligi kelib chiqadi. ►

Misol. Ushbu $\sum_{k=1}^{\infty} \frac{\cos kx}{k} = \frac{\cos x}{1} + \frac{\cos 2x}{2} + \dots + \frac{\cos kx}{k} + \dots$ qator yaqinlashuvchanlikka tekshirilsin, bunda x – tayinlangan haqiqiy son.

◀ Agar $x = 2\pi$ bo'lsa, berilgan

$$\sum_{k=1}^{\infty} \frac{\cos kx}{k} = \sum_{k=1}^{\infty} \frac{\cos 2\pi \cdot k}{k} = \sum_{k=1}^{\infty} \frac{1}{k}$$

qator garmonik qator bo'lib, u uzoqlashuvchi bo'ladi.

Ayтайlik, $x \neq 2\pi$ bo'lsin. Berilgan qatorda

$$a_k = \cos kx, \quad b_k = \frac{1}{k}$$

belgilashlarni bajaramiz.

Ravshanki, $\{b_k\} = \left\{ \frac{1}{k} \right\}$ ketma-ketlik kamayuvchi va cheksiz kichik miqdor bo'ladi ($k \rightarrow \infty$ da $\frac{1}{k} \rightarrow 0$).

Endi $\sum_{k=1}^{\infty} a_k = \sum_{k=1}^{\infty} \cos kx$ qatorning qisman yig'indisi S_n ni topamiz:

$$\begin{aligned} S_n &= \sum_{k=1}^n \cos kx = \frac{1}{2 \sin \frac{x}{2}} \sum_{k=1}^n 2 \sin \frac{x}{2} \cos kx = \\ &= \frac{1}{2 \sin \frac{x}{2}} \sum_{k=1}^n \left[\sin \left(k + \frac{1}{2} \right) x - \sin \left(k - \frac{1}{2} \right) x \right] = \frac{\sin \left(n + \frac{1}{2} \right) x - \sin \frac{x}{2}}{2 \sin \frac{x}{2}}. \end{aligned}$$

Keyingi munosabatdan, 2π ga karrali bo'lmagan x lar uchun

$$|S_n| \leq \frac{1}{\left| \sin \frac{x}{2} \right|}$$

bo'lishi kelib chiqadi. Demak, $\{S_n\}$ ketma-ketlik chegaralangan. Unda berilgan qator 2- teorema ko'ra yaqinlashuvchi bo'ladi. ►

Mashqlar

1. Quyidagi munosabatda $2n$ xatolik topilsin:

$$\begin{aligned} \ln 2 &= 1 - \frac{1}{2} + \frac{1}{3} - \frac{1}{4} + \dots = \left(1 + \frac{1}{2} + \frac{1}{3} + \frac{1}{4} + \dots\right) - 2\left(\frac{1}{2} + \frac{1}{4} + \dots\right) = \\ &= \left(1 + \frac{1}{2} + \frac{1}{3} + \frac{1}{4} + \dots\right) - \left(1 + \frac{1}{2} + \frac{1}{3} + \frac{1}{4} + \dots\right) = 0. \end{aligned}$$

2. Ushbu $\sum_{n=1}^{\infty} \frac{\cos \frac{n\pi}{5}}{\sqrt{n} \ln(n+1)} \left(1 + \frac{1}{n}\right)^{-\pi}$ qator yaqinlashuvchanlikka tekshirilsin.

54- ma'ruza

Cheksiz ko'paytmalar

1°. **Cheksiz ko'paytma tushunchasi.** Faraz qilaylik, biror

$$\{c_n\}: c_1, c_2, c_3, \dots, c_n, \dots$$

haqiqiy sonlar ketma-ketligi berilgan bo'lsin. Ular yordamida ushbu

$$c_1 \cdot c_2 \cdot c_3 \cdot \dots \cdot c_n \dots \quad (1)$$

ifodani tuzamiz.

(1) ifoda *cheksiz ko'paytma* deyiladi va u $\prod_{n=1}^{\infty} c_n$ kabi belgilanadi:

$$\prod_{n=1}^{\infty} c_n = c_1 \cdot c_2 \cdot c_3 \cdot \dots \cdot c_n \dots,$$

bunda $c_1, c_2, \dots, c_n \dots$ sonlar cheksiz ko'paytmaning hadlari, c_n esa ko'paytmaning umumiy yoki n - hadi deyiladi.

Quyidagi $P_n = c_1 \cdot c_2 \dots c_n$, ($n = 1, 2, 3, \dots$)

ko'paytma (1) cheksiz ko'paytmaning n - qismaniy ko'paytmasi deyiladi.

Demak, (1) cheksiz ko'paytma berilganda har doim uning qismaniy ko'paytmalaridan iborat ushbu $\{P_n\}$:

$$P_1, P_2, P_3, \dots, P_n, \dots$$

ketma-ketlikni hosil qilish mumkin. Masalan,

$$\left(1 - \frac{1}{2^2}\right) \cdot \left(1 - \frac{1}{3^2}\right) \dots \left(1 - \frac{1}{n^2}\right) \dots, \quad (n = 2, 3, \dots)$$

cheksiz ko'paytmaning n - qismaniy ko'paytmasi

$$\begin{aligned} P_n &= \left(1 - \frac{1}{2^2}\right) \cdot \left(1 - \frac{1}{3^2}\right) \dots \left(1 - \frac{1}{n^2}\right) = \\ &= \frac{1}{2} \cdot \frac{3}{2} \cdot \frac{2}{3} \cdot \frac{4}{3} \dots \frac{n-1}{n} \cdot \frac{n+1}{n} = \frac{1}{2} \cdot \frac{n+1}{n}, \quad (n = 2, 3, 4, \dots) \end{aligned}$$

bo'lib, ulardan tuzilgan $\{P_n\}$ ketma-ketlik

$$\frac{3}{4}, \frac{2}{3}, \frac{5}{8}, \frac{3}{5}, \dots, \frac{1}{2} \cdot \frac{n+1}{n}, \dots$$

bo'ladi.

1- ta'rif. Agar $n \rightarrow \infty$ da $\{P_n\}$ ketma-ketlik noldan farqli chekli P songa intilsa (yaqinlashsa), (1) cheksiz ko'paytma yaqinlashuvchi deyiladi, P esa uning qiymati deyiladi:

$$\lim_{n \rightarrow \infty} P_n = P, \quad P = \prod_{n=1}^{\infty} P_n.$$

Agar $\{P_n\}$ ketma-ketlik limitga ega bo'lmasa (yoki uning limiti 0 bo'lsa), (1) cheksiz ko'paytma uzoqlashuvchi deyiladi.

Masalan, yuqorida keltirilgan $\prod_{n=2}^{\infty} \left(1 - \frac{1}{n^2}\right)$ cheksiz ko'paytma uchun

$$\lim_{n \rightarrow \infty} P_n = \lim_{n \rightarrow \infty} \frac{1}{2} \cdot \frac{n+1}{n} = \frac{1}{2}$$

bo'ladi. Demak, $\prod_{n=2}^{\infty} \left(1 - \frac{1}{n^2}\right)$ cheksiz ko'paytma yaqinlashuvchi va uning qiymati $\frac{1}{2}$ ga teng.

2°. Yaqinlashuvchi cheksiz ko‘paytmaning xossalari. Aytaylik, biror

$$\prod_{n=1}^{\infty} c_n = c_1 \cdot c_2 \cdot c_3 \cdot \dots \cdot c_n \cdot \dots \quad (1)$$

cheksiz ko‘paytma berilgan bo‘lsin.

Ushbu

$$\prod_{n=m+1}^{\infty} c_n = c_{m+1} \cdot c_{m+2} \cdot \dots \quad (2)$$

cheksiz ko‘paytma (bunda m – tayinlangan natural son) (1) cheksiz ko‘paytmaning qoldig‘i deyiladi.

1) Agar (1) cheksiz ko‘paytma yaqinlashuvchi bo‘lsa, (2) cheksiz ko‘paytma ham yaqinlashuvchi bo‘ladi va aksincha.

◀ (1) cheksiz ko‘paytmaning qismaniy ko‘paytmasi

$$P_n = c_1 \cdot c_2 \cdot \dots \cdot c_n,$$

(2) cheksiz ko‘paytmaning qismaniy ko‘paytmasi

$$Q_k^{(m)} = c_{m+1} \cdot c_{m+2} \cdot \dots \cdot c_{m+k}$$

lar uchun

$$P_n = P_m \cdot Q_k^{(m)},$$

(bunda $n = m + k$) bo‘ladi. Bu munosabatdan, $n \rightarrow \infty$ da P_n ning chekli limitga ega bo‘lishidan $k \rightarrow \infty$ da $Q_k^{(m)}$ ning ham chekli limitga ega bo‘lishi; shuningdek, $k \rightarrow \infty$ da $Q_k^{(m)}$ ning chekli limitga ega bo‘lishidan, $n \rightarrow \infty$ da P_n ning ham chekli limitga ega bo‘lishi kelib chiqadi. ▶

2) Agar (1) cheksiz ko‘paytma yaqinlashuvchi bo‘lsa, u holda

$$\lim_{m \rightarrow \infty} (c_{m+1} \cdot c_{m+2} \cdot \dots \cdot c_{m+k} \dots) = 1$$

bo‘ladi.

◀ Aytaylik, (1) cheksiz ko‘paytma yaqinlashuvchi bo‘lib, uning qiymati P bo‘lsin. Unda

$$P_m \cdot c_{m+1} \cdot c_{m+2} \cdot \dots \cdot c_{m+k} \dots = P$$

bo‘lib, undan $m \rightarrow \infty$ da

$$c_{m+1} \cdot c_{m+2} \cdot \dots \cdot c_{m+k} \dots = \frac{P}{P_m} \rightarrow \frac{P}{P} = 1$$

bo‘lishi kelib chiqadi. ▶

3) Agar (1) cheksiz ko'paytma yaqinlashuvchi bo'lsa, u holda

$$\lim_{n \rightarrow \infty} c_n = 1$$

bo'ladi.

◀ Aytaylik, (1) cheksiz ko'paytma yaqinlashuvchi bo'lib, uning qiymati P bo'lsin:

$$\lim_{n \rightarrow \infty} P_n = \lim_{n \rightarrow \infty} (c_1 \cdot c_2 \cdot \dots \cdot c_n) = P.$$

U holda $P_n = P_{n-1} \cdot c_n$, ya'ni $c_n = \frac{P_n}{P_{n-1}}$ bo'lib,

$$\lim_{n \rightarrow \infty} c_n = \lim_{n \rightarrow \infty} \frac{P_n}{P_{n-1}} = \frac{P}{P} = 1$$

bo'ladi. ▶

Yuqorida keltirilgan xossalardan quyidagi xulosalarni chiqarish mumkin.

Cheksiz ko'paytmalarning yaqinlashishida, ularning dastlabki chekli sondagi hadlarining ta'siri bo'lmaydi.

Agar cheksiz ko'paytma yaqinlashuvchi bo'lsa, unda $n \rightarrow \infty$ da $c_n \rightarrow 1$ bo'lganligi sababli, uning biror hadidan boshlab keyingi hadlarini musbat deb olish mumkin bo'ladi.

Bu xossalar yaqinlashuvchi cheksiz ko'paytmalarda ularning hadlarini musbat deb olish imkonini beradi.

3°. Cheksiz ko'paytmalar bilan qatorlar orasidagi bog'lanish. Faraz qilaylik,

$$\prod_{n=1}^{\infty} c_n = c_1 \cdot c_2 \cdot \dots \cdot c_n \cdot \dots, \quad (c_n > 0, \quad n = 1, 2, \dots)$$

cheksiz ko'paytma berilgan bo'lsin. Bu cheksiz ko'paytma hadlarining logarifmlaridan ushbu

$$\sum_{n=1}^{\infty} \ln c_n = \ln c_1 + \ln c_2 + \dots + \ln c_n + \dots \quad (3)$$

qatorni hosil qilamiz.

1- teorema. (1) cheksiz ko'paytmaning yaqinlashuvchi bo'lishi uchun (3) qatorning yaqinlashuvchi bo'lishi zarur va yetarli.

◀ **Zarurligi.** Aytaylik, (1) cheksiz ko'paytma yaqinlashuvchi bo'lsin:

$$\lim_{n \rightarrow \infty} P_n = \lim_{n \rightarrow \infty} (c_1 \cdot c_2 \cdot \dots \cdot c_n) = P, \quad (P - \text{chekli son}).$$

U holda (3) qatorning qisman yig'indisi uchun

$$S_n = \sum_{k=1}^n \ln c_k = \ln c_1 + \ln c_2 + \dots + \ln c_n = \ln(c_1 \cdot c_2 \cdot \dots \cdot c_n)$$

bo'lib,

$$\lim_{n \rightarrow \infty} S_n = \lim_{n \rightarrow \infty} \ln(c_1 \cdot c_2 \cdot \dots \cdot c_n) = \ln P$$

bo'ladi. Demak, (3) qator yaqinlashuvchi.

Yetariligi. Aytaylik, (3) qator yaqinlashuvchi bo'lsin:

$$\lim_{n \rightarrow \infty} S_n = \lim_{n \rightarrow \infty} \sum_{k=1}^n \ln c_k = \lim_{n \rightarrow \infty} \ln(c_1 \cdot c_2 \cdot \dots \cdot c_n) = S.$$

U holda (1) cheksiz ko'paytmaning qisman ko'paytmasi uchun

$$P_n = c_1 \cdot c_2 \cdot \dots \cdot c_n = e^{\ln(c_1 \cdot c_2 \cdot \dots \cdot c_n)}$$

bo'lib,

$$\lim_{n \rightarrow \infty} P_n = \lim_{n \rightarrow \infty} e^{\ln(c_1 \cdot c_2 \cdot \dots \cdot c_n)} = e^S$$

bo'ladi. Demak, (1) cheksiz ko'paytma yaqinlashuvchi. ►

Ko'pincha, $\prod_{n=1}^{\infty} c_n$ cheksiz ko'paytmani o'rganishda, uning umumiy hadi c_n ni quyidagicha

$$c_n = 1 + a_n$$

ifodalash qulay bo'ladi. U holda (1) cheksiz ko'paytma

$$\prod_{n=1}^{\infty} (1 + a_n)$$

ko'rinishga, cheksiz qator esa

$$\sum_{n=1}^{\infty} \ln(1 + a_n)$$

ko'rinishga ega bo'ladi.

Faraz qilaylik, n ning ($n \in \mathbb{N}$) yetarlicha katta qiymatlarida

$$a_n > 0 \quad (\text{yoki } a_n < 0)$$

bo'lsin.

2- teorema. Ushbu $\prod_{n=1}^{\infty} (1 + a_n)$

cheksiz ko'paytmaning yaqinlashuvchi bo'lishi uchun

$$\sum_{n=1}^{\infty} a_n$$

qatorning yaqinlashuvchi bo'lishi zarur va yetarli.

◀ Ravshanki, $\prod_{n=1}^{\infty} (1 + a_n)$ cheksiz ko'paytma va $\sum_{n=1}^{\infty} a_n$ qatorning yaqinlashuvchi bo'lishi uchun avvalo

$$\lim_{n \rightarrow \infty} a_n = 0$$

bo'lishi kerak. Shu munosabat bajarilsin.

Keltirilgan teoremaning isboti

$$\lim_{n \rightarrow \infty} \frac{\ln(1+a_n)}{a_n} = 1$$

munosabat hamda 1- teoremaning qo'llanishidan kelib chiqadi. ▶

Masalan, bu teoremadan foydalanib, ushbu

$$\prod_{n=1}^{\infty} \left(1 + \frac{1}{n^\alpha}\right) = (1+1) \cdot \left(1 + \frac{1}{2^\alpha}\right) \cdot \left(1 + \frac{1}{3^\alpha}\right) \cdot \dots \cdot \left(1 + \frac{1}{n^\alpha}\right) \dots$$

cheksiz ko'paytmaning $\alpha > 1$ bo'lganda yaqinlashuvchi bo'lishini

(chunki $\sum_{n=1}^{\infty} \frac{1}{n^\alpha}$, ($\alpha > 1$) – yaqinlashuvchi),

$$\prod_{n=1}^{\infty} \left(1 + \frac{1}{n}\right) = (1+1) \cdot \left(1 + \frac{1}{2}\right) \cdot \left(1 + \frac{1}{3}\right) \dots \left(1 + \frac{1}{n}\right) \dots$$

cheksiz ko'paytmaning esa uzoqlashuvchi bo'lishini (chunki $\sum_{n=1}^{\infty} \frac{1}{n}$ –

uzoqlashuvchi) topamiz.

Mashqlar

1. Ushbu
$$\prod_{n=1}^{\infty} (1 + x^{2n}), \quad (|x| < 1)$$

cheksiz ko'paytmaning yaqinlashuvchiligi ko'rsatilsin va qiymati topilsin.

2. Ushbu
$$\prod_{n=1}^{\infty} \frac{e^{\frac{1}{n}}}{1 + \frac{1}{n}} = e^c$$

tenglik isbotlansin, bunda

$$c = \lim_{n \rightarrow \infty} \left(\sum_{k=1}^n \frac{1}{k} - \ln n \right)$$

(Eyler o'zgarmasi).

12- B O B
KO'P O'ZGARUVCHILI FUNKSIYALAR,
ULARNING LIMITI, UZLUKSIZLIGI

55- ma'ruza

R^m fazo. R^m fazoda ochiq va yopiq to'plamlar

1°. R^m fazo tushunchasi. Haqiqiy sonlar to'plami R yordamida ushbu

$$\underbrace{R \times R \times \dots \times R}_{m \text{ ta}} = \{(x_1, x_2, \dots, x_m) : x_1 \in R, x_2 \in R, \dots, x_m \in R\} \quad (1)$$

to'plamni (R ning dekart ko'paytmalaridan tuzilgan to'plamni) hosil qilaylik. Ravshanki, (1) to'plamning har bir elementi m ta x_1, x_2, \dots, x_m haqiqiy sonlardan tashkil topgan tartiblangan m lik

$$(x_1, x_2, \dots, x_m)$$

dan iborat bo'ladi. Uni (1) to'plamning nuqtasi deyilib, bitta harf bilan belgilanadi:

$$x = (x_1, x_2, \dots, x_m).$$

Bunda x_1, x_2, \dots, x_m sonlar x nuqtaning mos ravishda birinchi, ikkinchi, ..., m - koordinatalari deyiladi.

Agar $x = (x_1, x_2, \dots, x_m)$, $y = (y_1, y_2, \dots, y_m)$ nuqtalar uchun $x_1 = y_1, x_2 = y_2, \dots, x_m = y_m$ bo'lsa, $x = y$ deyiladi.

Faraz qilaylik,

$$x = (x_1, x_2, \dots, x_m), y = (y_1, y_2, \dots, y_m)$$

lar (1) to'plamning ixtiyoriy ikki nuqtasi bo'lsin. Ushbu

$$\sqrt{\sum_{k=1}^m (y_k - x_k)^2}$$

miqdor x va y nuqtalar orasidagi masofa deyiladi va $\rho(x, y)$ kabi belgilanadi:

$$\rho(x, y) = \sqrt{\sum_{k=1}^m (y_k - x_k)^2}. \quad (2)$$

Endi masofaning xossalarini keltiramiz:

1) Har doim $\rho(x, y) \geq 0$ va $\rho(x, y) = 0 \Leftrightarrow x = y$ bo'ladi.

◀ (2) munosabatga ko'ra, har doim $\rho(x, y) \geq 0$ bo'ladi. Agar $\rho(x, y) = 0$ bo'lsa, u holda

$$(y_1 - x_1)^2 + (y_2 - x_2)^2 + \dots + (y_m - x_m)^2 = 0$$

bo'lib, natijada $x_1 = y_1, x_2 = y_2, \dots, x_m = y_m$, ya'ni $x = y$ bo'lishi kelib chiqadi. Aksincha, agar $x_1 = y_1, x_2 = y_2, \dots, x_m = y_m$ bo'lsa, unda (2) munosabatlardan foydalanib $\rho(x, y) = 0$ bo'lishini topamiz. ▶

2) $\rho(x, y)$ masofa x va y ularga nisbatan simmetrik bo'ladi:
 $\rho(x, y) = \rho(y, x)$.

◀ Bu xossanig isboti (2) munosabatlardan kelib chiqadi:

$$\rho(x, y) = \sqrt{\sum_{k=1}^m (y_k - x_k)^2} = \sqrt{\sum_{k=1}^m (x_k - y_k)^2} = \rho(y, x). \quad \blacktriangleright$$

3) (1) to'plamning ixtiyoriy

$x = (x_1, x_2, \dots, x_m), y = (y_1, y_2, \dots, y_m), z = (z_1, z_2, \dots, z_m)$
nuqtalari uchun

$$\rho(x, z) \leq \rho(x, y) + \rho(y, z)$$

tengsizlik o'rinli bo'ladi.

◀ Ma'lumki, ixtiyoriy a_1, a_2, \dots, a_m va b_1, b_2, \dots, b_m haqiqiy sonlar uchun

$$\sqrt{\sum_{k=1}^m (a_k + b_k)^2} \leq \sqrt{\sum_{k=1}^m a_k^2} + \sqrt{\sum_{k=1}^m b_k^2} \quad (3)$$

bo'ladi (qaralsin, [1], 12- bob, 1- §; odatda, bu tengsizlikni Koshi-Bunyakovskiy tengsizligi deyiladi). (3) tengsizlikda

$$a_k = y_k - x_k, b_k = z_k - y_k, (k = 1, 2, \dots, m)$$

deb topamiz:

$$\sqrt{\sum_{k=1}^m (z_k - x_k)^2} \leq \sqrt{\sum_{k=1}^m (y_k - x_k)^2} + \sqrt{\sum_{k=1}^m (z_k - y_k)^2}.$$

Bu esa

$$\rho(x, z) \leq \rho(x, y) + \rho(y, z)$$

bo'lishini bildiriladi. ►

Shunday qilib, (1) to'plamda (to'plam elementlari orasida) masofa tushunchasining kiritilishini hamda masofa uchta xossaga ega bo'lishini ko'rdik.

Odatda, (1) to'plam R^m fazo deyiladi. Demak,

$$R^m = \{(x_1, x_2, \dots, x_m) : x_1 \in R, x_2 \in R, \dots, x_m \in R\}.$$

Endi R^m fazodagi ba'zi bir to'plamlarni keltiramiz.

Aytaylik, biror $a = (a_1, a_2, \dots, a_m) \in R^m$ nuqta va $r > 0$ son berilgan bo'lsin.

Ushbu

$$B_r(a) = \{(x_1, x_2, \dots, x_m) \in R^m : \sqrt{(x_1 - a_1)^2 + \dots + (x_m - a_m)^2} < r\}$$

yoki qisqacha,

$$B_r(a) = \{x \in R^m : \rho(x, a) < r\}$$

to'plam markazi a nuqta, radiusi r bo'lgan shar (m o'lchovli shar) deyiladi.

Quyidagi

$$\bar{B}_r(a) = \{x \in R^m : \rho(x, a) \leq r\}$$

to'plam R^m fazoda yopiq shar,

$$B_r^0(a) = \{x \in R^m : \rho(x, a) = r\}$$

to'plam esa R^m fazoda sfera (m o'lchovli sfera) deyiladi.

Ravshanki,

$$\bar{B}_r(a) = B_r(a) \cup B_r^0(a)$$

bo'ladi.

Ushbu

$$\begin{aligned} & \prod(a_1, \dots, a_m; b_1, b_2, \dots, b_m) = \\ & = \{(x_1, x_2, \dots, x_m) \in R^m : a_1 < x_1 < b_1, a_2 < x_2 < b_2, \dots, a_m < x_m < b_m\} \end{aligned}$$

to'plam R^m fazoda parallelepiped deyiladi, bunda a_1, a_2, \dots, a_m ; b_1, b_2, \dots, b_m — haqiqiy sonlar.

2°. R^m fazoda nuqtaning atrofi. Biror $x^0 = (x_1^0, x_2^0, \dots, x_m^0) \in R^m$ nuqta hamda $\varepsilon > 0$ son berilgan bo'lsin.

1- ta'rif. Markazi x^0 nuqtada, radiusi ε bo'lgan R^m fazodagi shar $x^0 \in R^m$ nuqtaning sferik atrofi deyiladi va $U_\varepsilon(x^0)$ kabi belgilanadi:

$$U_\varepsilon(x^0) = \{x \in R^m : \rho(x, x^0) < \varepsilon\}.$$

2- ta'rif. Ushbu

$$\prod(\delta_1, \delta_2, \dots, \delta_m) = \{(x_1, x_2, \dots, x_m) \in R^m :$$

$$: x_1^0 - \delta_1 < x_1 < x_1^0 + \delta_1, x_2^0 - \delta_2 < x_2 < x_2^0 + \delta_2, \dots, x_m^0 - \delta_m < x_m < x_m^0 + \delta_m\}$$

parallelepiped x^0 nuqtaning *parallelepipedial atrofi* deyiladi va $\bar{U}_{\delta_1, \delta_2, \dots, \delta_m}(x^0)$ kabi belgilanadi, bunda $\delta_1 > 0, \delta_2 > 0, \dots, \delta_m > 0$.

R^m fazodagi nuqtaning bu atroflari orasidagi munosabatni quyidagi lemma ifodalaydi.

Lemma. $x^0 \in R^m$ nuqtaning har qanday $U_\varepsilon(x^0)$ sferik atrofi olinganda ham har doim x^0 nuqtaning shunday $\bar{U}_{\delta_1, \delta_2, \dots, \delta_m}(x^0)$ parallelepipedial atrofi topiladiki, bunda

$$\bar{U}_{\delta_1, \delta_2, \dots, \delta_m}(x^0) \subset U_\varepsilon(x^0)$$

bo'ladi.

Shuningdek, x^0 nuqtaning har qanday $\bar{U}_{\delta_1, \delta_2, \dots, \delta_m}(x^0)$ parallelepipedial atrofi olinganda ham har doim x^0 nuqtaning shunday $U_\varepsilon(x^0)$ sferik atrofi topiladiki, bunda

$$\bar{U}_\varepsilon(x^0) \subset U_{\delta_1 \delta_2 \dots \delta_m}(x^0)$$

bo'ladi.

◀ $x^0 \in R^m$ nuqtaning sferik atrofi

$$U_\varepsilon(x^0) = \{x \in R^m : \rho(x, x^0) < \varepsilon\}$$

berilgan bo'lsin. Demak, $\varepsilon > 0$ son berilgan. Unga ko'ra $\delta < \frac{\varepsilon}{\sqrt{m}}$ tengsizlikni qanoatlantiruvchi δ sonni olib, x^0 nuqtaning ushbu

$$\bar{U}_\delta(x^0) = \bar{U}_{\delta \delta \dots \delta}(x^0) = \{(x_1, x_2, \dots, x_m) \in R^m :$$

$$: x_1^0 - \delta < x_1 < x_1^0 + \delta, x_2^0 - \delta < x_2 < x_2^0 + \delta, \dots, x_m^0 - \delta < x_m < x_m^0 + \delta\}$$

parallelepipedial atrofni tuzamiz. Natijada x^0 nuqtaning

$$U_\varepsilon(x^0) \text{ va } \bar{U}_\delta(x^0)$$

atroflariga ega bo'lamiz.

Aytaylik, $\forall x \in \bar{U}_\delta(x^0)$ bo'lsin. U holda

$$|x_k - x_k^0| < \delta, \quad (k = 1, 2, \dots, m)$$

bo'lib,

$$\sqrt{\sum_{k=1}^m (x_k - x_k^0)^2} < \sqrt{\sum_{k=1}^m \delta^2} = \delta \cdot \sqrt{m}$$

bo'ladi. Yuqoridagi $\delta < \frac{\varepsilon}{\sqrt{m}}$ tengsizlikni e'tiborga olib topamiz:

$$\sqrt{\sum_{k=1}^m (x_k - x_k^0)^2} < \varepsilon.$$

Demak, $\rho(x, x_0) < \varepsilon$ bo'lib, $x \in U_\varepsilon(x^0)$ bo'ladi. Bundan

$$\bar{U}_\delta(x^0) \subset U_\varepsilon(x^0)$$

bo'lishi kelib chiqadi.

$x^0 \in R^m$ nuqtaning parallelepipedial atrofi

$$\bar{U}_{\delta_1 \delta_2 \dots \delta_m}(x^0) = \{(x_1, x_2, \dots, x_m) \in R^m :$$

$$: x_1^0 - \delta_1 < x_1 < x_1^0 + \delta_1, x_2^0 - \delta_2 < x_2 < x_2^0 + \delta_2, \dots, x_m^0 - \delta_m < x_m < x_m^0 + \delta_m \}$$

berilgan bo'lsin. Berilgan $\delta_1, \delta_2, \dots, \delta_m$ musbat sonlar yordamida

$$\varepsilon = \min \{\delta_1, \delta_2, \dots, \delta_m\}$$

sonini topib, x^0 nuqtaning ushbu

$$U_\varepsilon(x^0) = \{x \in R^m : \rho(x, x^0) < \varepsilon\}$$

sferik atrofni tuzamiz. Natijada x^0 nuqtaning

$$U_\varepsilon(x^0) \text{ va } \bar{U}_{\delta_1 \delta_2 \dots \delta_m}(x^0)$$

atroflariga ega bo'lamiz.

Aytaylik, $\forall x \in U_\varepsilon(x^0)$ bo'lsin. U holda

$$\rho(x, x^0) = \sqrt{\sum_{k=1}^m (x_k - x_k^0)^2} < \varepsilon \leq \delta_k, \quad (k = 1, 2, \dots, m)$$

bo'lib,

$$|x_k - x_k^0| < \delta_k, \quad (k = 1, 2, \dots, m)$$

bo'ladi. Bundan esa $x \in \bar{U}_{\delta_1 \delta_2 \dots \delta_m}(x^0)$ bo'lishi kelib chiqadi. Demak,

$$U_\varepsilon(x^0) \subset \bar{U}_{\delta_1 \delta_2 \dots \delta_m}(x^0). \blacktriangleright$$

Bu lemma R^m fazo nuqtasining bir atrofidan ikkinchi atrofiga o'tish imkonini beradi.

3°. R^m fazoda ochiq va yopiq to'plamlar. Aytaylik, R^m fazoda biror G to'plam ($G \subset R^m$) berilgan bo'lib, $x^0 \in G$ bo'lsin.

Agar x^0 nuqta G to'plamga tegishli bo'lgan $U_\varepsilon(x^0)$ atrofga ega bo'lsa, ($U_\varepsilon(x^0) \subset G$) x_0 nuqta G to'plamning ichki nuqtasi deyiladi.

3-ta'rif. G to'plamning har bir nuqtasi uning ichki nuqtasi bo'lsa, u *ochiq to'plam* deyiladi.

1- misol. R^m fazodagi ushbu

$$B_r(a) = \{x \in R^m : \rho(x, a) < r\}$$

sharning ochiq to'plam ekanligi ko'rsatilsin.

◀ $\forall x^0 \in B_r(a)$ nuqtani olamiz. Unda

$$r - \rho(x^0, a)$$

miqdor musbat bo'ladi. Uni δ deylik:

$$\delta = r - \rho(x^0, a) \quad (22\text{-chizma}).$$

Endi x^0 nuqtaning ushbu

$$U_\delta(x^0) = \{x \in R^m : \rho(x, x^0) < \delta\}$$

atrofini qaraymiz.

Bunda $U_\delta(x^0) \subset B_r(a)$ bo'ladi. Haqiqatan ham,

$$\forall x \in U_\delta(x^0) \Rightarrow \rho(x, x^0) < \delta$$

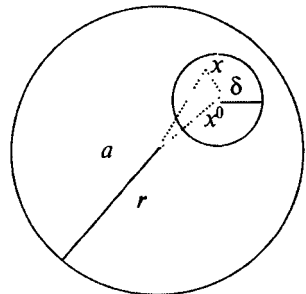

22- chizma.

bo'lib, masofaning 3- xossasiga ko'ra

$$\rho(x, a) \leq \rho(x, x^0) + \rho(x^0, a) < \delta + \rho(x^0, a) = r$$

bo'ladi. Demak,

$$\forall x \in U_\delta(x^0) \Rightarrow x \in B_r(x^0).$$

Bundan $U_\delta(x^0) \subset B_r(x^0)$ bo'lishi kelib chiqadi.

Demak, $B_r(a)$ to'plamning har bir nuqtasi uning ichki nuqtasi bo'ladi. Binobarin, $B_r(a)$ — ochiq to'plam. ►

Aytaylik, $F \subset R^m$ to'plam hamda $x^0 \in R^m$ nuqta berilgan bo'lsin. Agar x^0 nuqtaning ixtiyoriy $U_\varepsilon(x^0)$ atrofida ($\forall \varepsilon > 0$) F to'plamning x^0 dan farqli kamida bitta nuqtasi bo'lsa, x^0 nuqta F to'plamning limit nuqtasi deyiladi.

Masalan, ushbu

$$B_r(a) = \{x \in R^m : \rho(x, a) < r\}$$

to'plamning har bir nuqtasi uning limit nuqtasi bo'ladi. Ayni paytda,

$$B_r^0 = \{x \in R^m : \rho(x, a) = r\}$$

to'plamning barcha nuqtalari ham shu $B_r(a)$ to'plamning limit nuqtasi bo'ladi. Biroq, bu limit nuqtalar $B_r(a)$ to'plamga tegishli bo'lmaydi.

4- ta'rif. Agar $F \subset R^m$ to'plamning barcha limit nuqtalari shu to'plamga tegishli bo'lsa, F yopiq to'plam deyiladi.

Masalan,

$$\overline{B}_r(a) = \{x \in R^m : \rho(x, a) \leq r\}$$

to'plam (R^m fazodagi yopiq shar) yopiq to'plam bo'ladi

Biror $M \subset R^m$ to'plam hamda $x^0 \in R^m$ nuqtani qaraylik.

Agar x^0 nuqtaning ixtiyoriy $U_\varepsilon(x^0)$ atrofida ham M to'plamning, ham $R^m \setminus M$ to'plamning nuqtalari bo'lsa, x^0 nuqta M to'plamning chegaraviy nuqtasi deyiladi. M to'plamning barcha chegaraviy nuqtalari uning chegarasini tashkil etadi. M to'plamning chegarasi $\partial(M)$ kabi belgilanadi. Masalan,

$$B_r^0(a) = \{x \in R^m : \rho(x, a) = r\}$$

to'plam

$$B_r(a) = \{x \in R^m : \rho(x, a) < r\}$$

R^m fazoda chekli sondagi nuqtalar berilgan bo'lsin. Bu nuqtalarni birin-ketin to'g'ri chiziq kesmalari bilan birlashtirishdan tashkil topgan chiziq *siniq chiziq* deyiladi.

Agar $M \subset R^m$ to'plamning ixtiyoriy ikki nuqtasini birlashtiruvchi shunday siniq chiziq topilsaki, u ushbu M to'plamga tegishli bo'lsa, M *bog'lamli to'plam* deyiladi.

5-ta'rif. Agar $M \subset R^m$ to'plam ochiq hamda bog'lamli to'plam bo'lsa, u *soha* deyiladi. Masalan,

$$B_r(a) = \{x \in R^m : \rho(x, a) < r\}$$

to'plam soha bo'ladi.

5°. Xususiy hollar. $m = 1$ bo'lganda $R^m = R$ bo'lib, u barcha haqiqiy sonlardan iborat to'plam bo'ladi. Bu to'plamning har bir elementi to'g'ri chiziq nuqtasini, to'plamning o'zi esa to'g'ri chiziqni ifodalaydi.

Ikki $x \in R, y \in R$ nuqtalar orasidagi masofa

$$\rho(x, y) = |x - y|,$$

$x_0 \in R$ nuqtaning atrofi

$$U_\varepsilon(x_0) = \{x \in R : \rho(x, x_0) < \varepsilon\} = (x_0 - \varepsilon, x_0 + \varepsilon)$$

bo'ladi.

$m = 2$ bo'lganda $R^m = R^2$ bo'lib, u barcha tekislik nuqtalaridan iborat to'plam bo'ladi. Bu to'plamning ikki $x = (x_1, x_2), y = (y_1, y_2)$ nuqtalari orasidagi masofa

$$\rho(x, y) = \sqrt{(y_1 - x_1)^2 + (y_2 - x_2)^2},$$

$x^0 = (x_0, y_0)$ nuqtaning sferik atrofi

$$\begin{aligned} U_\varepsilon(x^0) &= \{(x, y) \in R^2 : \rho((x, y), (x_0, y_0)) < \varepsilon\} = \\ &= \{(x, y) \in R^2 : \sqrt{(x - x_0)^2 + (y - y_0)^2} < \varepsilon\} \end{aligned}$$

bo'ladi.

R^2 fazoda ushbu

$$\{(x, y) \in R^2 : \rho((x, y), (x_0, y_0)) < r\}$$

to'plam ochiq, quyidagi

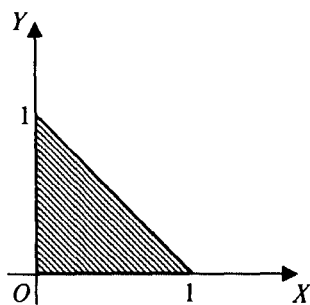
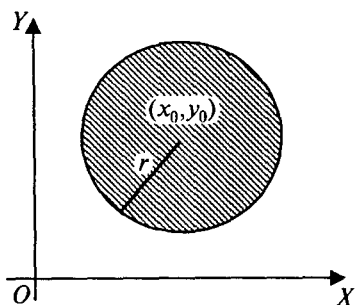

23- chizma.

$$\{(x, y) \in R^2 : x \geq 0, y \geq 0, x + y \leq 1\}$$

to'plam esa yopiq to'plam bo'ladi. Ular 23- chizmada tavsirlangan.

Mashqlar

1. Agar $G_1 \subset R^m$, $G_2 \subset R^m$ ochiq to'plamlar bo'lsa,

$$G_1 \cup R^m, G_2 \cap R^m$$

to'plamlarning ochiq to'plam bo'lishi ko'rsatilsin.

2. Agar $F_1 \subset R^m$, $F_2 \subset R^m$ yopiq to'plamlar bo'lsa,

$$F_1 \cup R^m, F_2 \cap R^m$$

to'plamlarning yopiq to'plam bo'lishi ko'rsatilsin.

56- ma'ruza

R^m fazoda ketma-ketlik va uning limiti

1°. R^m fazoda ketma-ketlik va uning limiti tushunchalari. Aytaylik, biror qoidaga ko'ra har bir natural son n ga R^m fazoning bitta

$$x^{(n)} = (x_1^{(n)}, x_2^{(n)}, \dots, x_m^{(n)}), \quad (n = 1, 2, \dots)$$

nuqtasi mos qo'yilgan bo'lsin. Bu moslik natijasida R^m fazo nuqtalaridan tashkil topgan ushbu

$$(x_1^{(1)}, x_2^{(1)}, \dots, x_m^{(1)}), (x_1^{(2)}, x_2^{(2)}, \dots, x_m^{(2)}), \dots, (x_1^{(n)}, x_2^{(n)}, \dots, x_m^{(n)}), \dots$$

yoki qisqacha,

$$x^{(1)}, x^{(2)}, \dots, x^{(n)}, \dots$$

to'plam hosil bo'ladi. Uni R^m fazoda ketma-ketlik deyilib, $\{x^{(n)}\}$ kabi belgilanadi. Demak, $\{x^{(n)}\}$ ketma-ketlikning hadlari R^m fazo nuqtalaridan iborat bo'lib, bu nuqtalarning koordinatalari m ta

$$\{x_1^{(n)}\}, \{x_2^{(n)}\}, \dots, \{x_m^{(n)}\}, \quad (n = 1, 2, \dots)$$

sonlar ketma-ketliklarini yuzaga keltiradi.

Faraz qilaylik, R^m fazoda $\{x^{(n)}\}$:

$$x^{(1)}, x^{(2)}, \dots, x^{(n)}, \dots \quad (1)$$

ketma-ketlik hamda

$$a = (a_1, a_2, \dots, a_m) \in R^m$$

nuqta berilgan bo'lsin.

1- ta'rif. Agar $\forall \varepsilon > 0$ olinganda ham shunday $n_0 \in N$ son topilsaki, barcha $n > n_0$ uchun

$$\rho(x^{(n)}, a) < \varepsilon,$$

ya'ni

$$\forall \varepsilon > 0, \exists n_0 \in N, \forall n > n_0 : \rho(x^{(n)}, a) < \varepsilon$$

bo'lsa, a nuqta $\{x^{(n)}\}$ ketma-ketlikning limiti deyiladi va

$$\lim_{n \rightarrow \infty} x^{(n)} = a \quad \text{yoki} \quad n \rightarrow \infty \text{ da } x^{(n)} \rightarrow a$$

kabi belgilanadi.

$$\forall n > n_0 \text{ da}$$

$$\rho(x^{(n)}, a) < \varepsilon$$

tengsizlikning bajarilishi, (1) ketma-ketlikning n_0 dan katta nomerli hadlari a nuqtaning $U_\varepsilon(a)$ atrofiga tegishli bo'lishini bildiradi. Bu hol (1) ketma-ketlikning limitini quyidagicha ta'riflash imkonini beradi.

2- ta'rif. Agar $a \in R^m$ nuqtaning ixtiyoriy $U_\varepsilon(a)$ atrofi olinganda ham, $\{x^{(n)}\}$ ketma-ketlikning biror hadidan keyingi barcha hadlari shu atrofga tegishli bo'lsa, a nuqta $\{x^{(n)}\}$ ketma-ketlikning limiti deyiladi.

1- misol. R^m fazoda ushbu $\{x^{(n)}\} = \left\{ \frac{1}{n}, \frac{1}{n}, \dots, \frac{1}{n} \right\}$ ketma-ketlik-

ning limiti $a = (0, 0, \dots, 0)$ bo'lishi ko'rsatilsin.

◀ $\forall \varepsilon > 0$ sonini olib, unga ko'ra $n_0 = \left[\frac{\sqrt{m}}{\varepsilon} \right] + 1$ ni topamiz.

U holda $\forall n > n_0$ uchun

$$\rho(x^{(n)}, a) = \rho\left(\frac{1}{n}, \frac{1}{n}, \dots, \frac{1}{n}\right), (0, 0, \dots, 0) = \frac{\sqrt{m}}{n} < \frac{\sqrt{m}}{n_0} = \frac{\sqrt{m}}{\left[\frac{\sqrt{m}}{\varepsilon} \right] + 1} < \varepsilon$$

bo'ladi. Demak, $\lim_{n \rightarrow \infty} x^{(n)} = a$. ▶

2°. Ketma-ketlik limitining mavjudligi. Faraz qilaylik, R^m fazoda $\{x^{(n)}\}$ ketma-ketlik va $a \in R^m$ nuqta berilgan bo'lsin.

1- teorema. Agar R^m fazoda

$$x^{(n)} = (x_1^{(n)}, x_2^{(n)}, \dots, x_m^{(n)}), \quad (n = 1, 2, \dots)$$

ketma-ketlik

$$a = (a_1, a_2, \dots, a_m)$$

limitga ega bo'lsa: $\lim_{n \rightarrow \infty} x^{(n)} = a$,

u holda

$$\lim_{n \rightarrow \infty} x_1^{(n)} = a_1,$$

$$\lim_{n \rightarrow \infty} x_2^{(n)} = a_2,$$

.....

$$\lim_{n \rightarrow \infty} x_m^{(n)} = a_m$$

bo'ladi.

◀ Aytaylik $\lim_{n \rightarrow \infty} x^{(n)} = a$ bo'lsin. Limit ta'rifiga binoan $\forall n > n_0 \in N$ uchun

$$x^{(n)} \in U_\varepsilon(a) = \{x \in R^m : \rho(x, a) < \varepsilon\}, \quad (\forall \varepsilon > 0)$$

bo'ladi. Ravshanki,

$$U_\varepsilon(a) \subset \tilde{U}_\varepsilon(a),$$

bunda

$$\tilde{U}_\varepsilon(a) = \{(x_1, x_2, \dots, x_m) \in R^m :$$

$$a_1 - \varepsilon < x_1 < a_1 + \varepsilon, a_2 - \varepsilon < x_2 < a_2 + \varepsilon, \dots, a_m - \varepsilon < x_m < a_m + \varepsilon\}.$$

Keyingi munosabatlardan, $\forall n > n_0$ uchun

$$a_1 - \varepsilon < x_1^{(n)} < a_1 + \varepsilon,$$

$$a_2 - \varepsilon < x_2^{(n)} < a_2 + \varepsilon,$$

.....

$$a_m - \varepsilon < x_m^{(n)} < a_m + \varepsilon,$$

ya'ni

$$|x_1^{(n)} - a_1| < \varepsilon,$$

$$|x_2^{(n)} - a_2| < \varepsilon,$$

.....

$$|x_m^{(n)} - a_m| < \varepsilon$$

bo'lishini topamiz. Bundan esa

$$\lim_{n \rightarrow \infty} x_1^{(n)} = a_1,$$

$$\lim_{n \rightarrow \infty} x_2^{(n)} = a_2,$$

.....

$$\lim_{n \rightarrow \infty} x_m^{(n)} = a_m$$

bo'lishi kelib chiqadi. ►

2- teorema. Agar R^m fazodagi

$$\{x^n\} = \{(x_1^{(n)}, x_2^{(n)}, \dots, x_m^{(n)})\}, \quad (n = 1, 2, \dots)$$

ketma-ketlik va $a = (a_1, a_2, \dots, a_m)$ nuqta uchun

$$\lim_{n \rightarrow \infty} x_1^{(n)} = a_1,$$

$$\lim_{n \rightarrow \infty} x_2^{(n)} = a_2,$$

.....

$$\lim_{n \rightarrow \infty} x_m^{(n)} = a_m$$

bo'lsa, u holda $\{x^{(n)}\}$ ketma-ketlik limitga ega bo'lib,

$$\lim_{n \rightarrow \infty} x^{(n)} = a$$

bo'ladi.

◀ Teoremaning sharti hamda limit ta'rifidan foydalanib topamiz:

$$\lim_{n \rightarrow \infty} x_1^{(n)} = a_1 \Rightarrow \forall \varepsilon > 0, \exists n_0^{(1)} \in N, \forall n > n_0^{(1)} : |x_1^{(n)} - a_1| < \frac{\varepsilon}{\sqrt{m}},$$

$$\lim_{n \rightarrow \infty} x_2^{(n)} = a_2 \Rightarrow \forall \varepsilon > 0, \exists n_0^{(2)} \in N, \forall n > n_0^{(2)} : |x_2^{(n)} - a_2| < \frac{\varepsilon}{\sqrt{m}},$$

.....

$$\lim_{n \rightarrow \infty} x_m^{(n)} = a_m \Rightarrow \forall \varepsilon > 0, \exists n_0^{(m)} \in N, \forall n > n_0^{(m)} : |x_m^{(n)} - a_m| < \frac{\varepsilon}{\sqrt{m}}$$

bo'ladi.

Agar

$$n_0 = \max \{n_0^{(1)}, n_0^{(2)}, \dots, n_0^{(m)}\}$$

deyilsa, u holda $\forall n > n_0$ da bir yo'la

$$|x_k^{(n)} - a_k| < \frac{\varepsilon}{\sqrt{m}}, \quad (k = 1, 2, \dots, m)$$

tengsizliklar bajariladi. U holda

$$\sqrt{\sum_{k=1}^m (x_k^{(n)} - a_k)^2} < \sqrt{\sum_{k=1}^m \left(\frac{\varepsilon}{\sqrt{m}}\right)^2} = \varepsilon,$$

ya'ni

$$\rho(x^{(n)}, a) < \varepsilon$$

bo'ladi. Demak,

$$\lim_{n \rightarrow \infty} x^{(n)} = a. \quad \blacktriangleright$$

Bu teoremalardan quyidagi tasdiq kelib chiqadi.

R^m fazoda $\{x^{(n)}\} = \{(x_1^{(n)}, x_2^{(n)}, \dots, x_m^{(n)})\}$ ketma-ketlik

$a = (a_1, a_2, \dots, a_m)$ limit:

$$\lim_{n \rightarrow \infty} x^{(n)} = a$$

ga ega bo'lishi uchun bir yo'la

$$\lim_{n \rightarrow \infty} x_1^{(n)} = a_1,$$

$$\lim_{n \rightarrow \infty} x_2^{(n)} = a_2,$$

.....

$$\lim_{n \rightarrow \infty} x_m^{(n)} = a_m$$

bo'lishi zarur va yetarli.

Bu muhim tasdiq bo'lib, u R^m fazodagi ketma-ketliklar limitlarini o'rganishni sonlar ketma-ketliklar limitlarini o'rganishga olib keladi. Sonlar ketma-ketliklarining limiti esa 6-8- ma'ruzalarda batafsil bayon etilgan.

Agar (1) ketma-ketlik limitga ega bo'lsa, u *yaqinlashuvchi ketma-ketlik* deyiladi.

Yuqorida keltirilgan tasdiqdan foydalanib, isbotlanadigan muhim teoremani keltiramiz. Avvalo R^m fazoda ketma-ketlikning fundamentalligini ta'riflaymiz.

3- ta'rif. R^m fazoda $\{x^{(n)}\}$ ketma-ketlik berilgan bo'lsin. Agar $\forall \varepsilon > 0$ olinganda ham shunday $n_0 \in N$ topilsaki, $\forall n > n_0, \forall P > n_0$ lar uchun

$$\rho(x^{(n)}, x^{(P)}) < \varepsilon$$

tengsizlik bajarilsa, $\{x^{(n)}\}$ *fundamental ketma-ketlik* deyiladi.

3- teorema. (Koshi teoremasi) $\{x^{(n)}\}$ ketma-ketlikning yaqinlashuvchi bo'lishi uchun uning fundamental bo'lishi zarur va yetarli.

Bu teorema 9- ma'ruzada keltirilgan 3- teorema kabi isbotlanadi.

3°. Ichma-ich joylashgan yopiq sharlar prinsipi. R^m fazoda markazlari

$$a^{(n)} = (a_1^{(n)}, a_2^{(n)}, \dots, a_m^{(n)}), \quad (n = 1, 2, \dots)$$

nuqtalarda, radiuslari $r_n > 0$ ($n = 1, 2, \dots$) bo'lgan ushbu

$$B_1 = \bar{B}_{r_1}(a^{(1)}) = \{x \in R^m : \rho(x, a^{(1)}) \leq r_1\},$$

$$B_2 = \bar{B}_{r_2}(a^{(2)}) = \{x \in R^m : \rho(x, a^{(2)}) \leq r_2\},$$

.....

$$B_n = \bar{B}_{r_n}(a^{(n)}) = \{x \in R^m : \rho(x, a^{(n)}) \leq r_n\},$$

.....

yopiq sharlar ketma-ketligini qaraylik. Agar bu yopiq sharlar ketma-ketligining hadlari uchun quyidagi

$$B_1 \supset B_2 \supset \dots \supset B_n \supset \dots$$

munosabat o'rinli bo'lsa, $\{B_n\}$ ichma-ich joylashgan yopiq sharlar ketma-ketligi deyiladi.

Aytaylik, $\{B_n\}$ R^m fazoda ichma-ich joylashgan yopiq sharlar ketma-ketligi bo'lsin.

4- teorema. Agar $n \rightarrow \infty$ da shar radiuslari r_n nolga intilsa, ya'ni

$$\lim_{n \rightarrow \infty} r_n = 0$$

bo'lsa, u holda barcha yopiq sharlarga tegishli bo'lgan a nuqta ($a \in R^m$) mavjud va u yagona bo'ladi.

◀ Shar markazlaridan tuzilgan

$$\{a^{(n)}\}, \quad (a^{(n)} \in R^m, \quad n = 1, 2, \dots)$$

ketma-ketlikni qaraylik. Uning fundamental ketma-ketlik bo'lishini ko'rsatamiz.

Shartga ko'ra $\lim_{n \rightarrow \infty} r_n = 0$. U holda

$$\forall \varepsilon > 0, \exists n_0 \in N, \quad n > n_0 : r_n < \varepsilon$$

bo'ladi. Ayni paytda, yopiq sharlar ichma-ich joylashganligidan ixtiyoriy

$$P > n > n_0$$

uchun

$$\bar{B}_{r_p}(a^{(P)}) \supset \bar{B}_{r_n}(a^{(n)})$$

bo'lib,

$$\rho(a^{(n)}, a^{(P)}) \leq r_p < \varepsilon \quad \text{bo'ladi.}$$

Demak, $\{a^{(n)}\}$ — fundamental ketma-ketlik. U holda Koshi teoremasiga ko'ra u yaqinlashuvchi bo'ladi:

$$\lim_{n \rightarrow \infty} a^{(n)} = a, \quad (a \in R^m).$$

Bu a nuqta $\bar{B}_{r_n}(a^{(n)})$ to'plamning limit nuqtasi va $\bar{B}_{r_n}(a^{(n)})$ yopiq bo'lganligi uchun $a \in \bar{B}_{r_n}(a^{(n)})$, ($n=1, 2, \dots$) bo'ladi. Demak, a — barcha sharlarga tegishli bo'lgan nuqta. Faraz qilaylik, a nuqtadan farqli barcha sharlarga tegishli bo'lgan b nuqta ($b \in R^m$) mavjud bo'lsin: $b \in \bar{B}_{r_n}(a^{(n)})$, $b \neq a$. Masofaning 3-xossasidan foydalanib topamiz:

$$\rho(a, b) \leq \rho(a, a^{(n)}) + \rho(a^{(n)}, b) \leq 2r_n.$$

Agar $n \rightarrow \infty$ da $r_n \rightarrow 0$ bo'lishini e'tiborga olsak, keyingi munosabatdan $\rho(a, b) = 0$, ya'ni $a = b$ bo'lishi kelib chiqadi. ►

Odatda, bu teorema *ichma-ich joylashgan yopiq sharlar prinsipi* deyiladi.

4°. Qisman ketma-ketliklar. Bolsano–Veyershtross teoremasi. R^m fazoda $\{x^{(n)}\}$:

$$x^{(1)}, x^{(2)}, \dots, x^{(n)}, \dots$$

ketma-ketlik berilgan bo'lsin. Ushbu ketma-ketlik

$$x^{(n_1)}, x^{(n_2)}, \dots, x^{(n_k)}, \dots,$$

bunda $n_1 < n_2 < \dots < n_k < \dots$; $n_k \in \mathbb{N}$, $k = 1, 2, \dots$,

berilgan $\{x^{(n)}\}$ ketma-ketlikning qisman ketma-ketligi deyiladi va u $\{x^{(n_k)}\}$ kabi belgilanadi. Ravshanki, bitta ketma-ketlikning turlicha qisman ketma-ketliklari bo'ladi.

Agar $\{x^{(n)}\}$ ketma-ketlik yaqinlashuvchi bo'lib,

$$\lim_{n \rightarrow \infty} x^{(n)} = a$$

bo'lsa, bu ketma-ketlikning har qanday qisman ketma-ketligi $\{x^{(n_k)}\}$ ham yaqinlashuvchi bo'lib,

$$\lim_{k \rightarrow \infty} x^{(n_k)} = a$$

bo'ladi. Bu tasdiqning isboti ketma-ketlik limiti ta'rifidan bevosita kelib chiqadi.

Aytaylik, R^m fazoda biror M to'plam berilgan bo'lsin: $M \subset R^m$. Agar R^m fazoda markazi $(0, 0, \dots, 0) \in R^m$, radiusi $r > 0$ bo'lgan shar

$$U^0 = \{(x_1, x_2, \dots, x_m) \in R^m : \rho((x_1, x_2, \dots, x_m), (0, 0, \dots, 0)) < r\}$$

topilsaki, bunda

$$M \subset U^0$$

bo'lsa, M chegaralangan to'plam deyiladi.

Endi Bolsano-Veyershtross teoremasini isbotsiz keltiramiz.

5-teorema. (Bolsano-Veyershtross teoremasi.) R^m fazoda har qanday chegaralangan ketma-ketlikdan yaqinlashuvchi qisman ketma-ketlik ajratish mumkin.

5°. Xususiy hollar. $m = 1$ bo'lganda $R^m = R$ bo'lib, undagi ketma-ketlik sonlar ketma-ketligi bo'ladi. Ma'lumki, sonlar ketma-ketligi va uning limiti 6–8- ma'ruzalarda batafsil o'rganilgan.

$m = 2$ bo'lganda $R^m = R^2$ bo'lib, undagi ketma-ketlik tekislik nuqtalaridan iborat

$$(x_1, y_1), (x_2, y_2), \dots, (x_n, y_n), \dots, \quad (x_n \in R, y_n \in R, n = 1, 2, \dots)$$

ketma-ketlik bo'ladi. Bu ketma-ketlikning limiti $\{x_n\}$ va $\{y_n\}$ sonlar ketma-ketliklarining limitlari orqali o'rganiladi.

Masalan, ushbu

$$\{(-1)^n, (-1)^n\}: (-1, -1), (1, 1), (-1, -1), \dots, ((-1)^n, (-1)^n), \dots$$

ketma-ketlik limitga ega bo'lmaydi, chunki

$$x_n = (-1)^n, y_n = (-1)^n, \quad (n = 1, 2, \dots)$$

ketma-ketliklar limitga ega emas.

Mashqlar

1. Agar $x^0 \in R^m$ nuqta $M \subset R^m$ to'plamning limit nuqtasi bo'lsa, M to'plam elementlaridan tashkil topgan va x^0 nuqtaga yaqinlashadigan:

$$\{x^{(n)}\}, \quad (x^{(n)} \in M, x^{(n)} \neq x_0, n = 1, 2, \dots)$$

ketma-ketlikning mavjudligi ko'rsatilsin.

2. Agar

$$\lim_{n \rightarrow \infty} x^{(n)} = a, \quad (x^{(n)} \in R^m, a \in R^m, n = 1, 2, \dots)$$

bo'lsa, $\{x^{(n)}\}$ ketma-ketlikning chegaralanganligi ko'rsatilsin.

57- ma'ruza

Ko'p o'zgaruvchili funksiya va uning limiti

1°. Ko'p o'zgaruvchili funksiya tushunchasi. Faraz qilaylik, R^m fazoda E to'plam berilgan bo'lsin: $E \subset R^m$.

1- ta'rif. Agar E to'plamdagi har bir $x = (x_1, x_2, \dots, x_m)$ nuqtaga biror f qoidaga ko'ra bitta haqiqiy u son mos qo'yilgan bo'lsa, E to'p-

lamda ko'p o'zgaruvchili (m ta o'zgaruvchili) funksiya berilgan (aniqlangan) deyiladi. Uni

$$f : x = (x_1, x_2, \dots, x_m) \rightarrow u \text{ yoki } u = f(x) = f(x_1, x_2, \dots, x_m)$$

$$(x = (x_1, x_2, \dots, x_m) \in R^m, u \in R)$$

kabi belgilanadi. Bunda E – funksiyaning berilish (aniqlanish) to'plami, x_1, x_2, \dots, x_m (erkli o'zgaruvchilar) – funksiya argumentlari, u esa x_1, x_2, \dots, x_m larning funksiyasi deyiladi.

Masalan, f – har bir

$$x = (x_1, x_2, \dots, x_m) \in M,$$

$$M = \{x \in R^m : \rho(x, 0) \leq 1\}$$

nuqtaga ushbu

$$(x_1, x_2, \dots, x_m) \rightarrow \sqrt{1 - x_1^2 - x_2^2 - \dots - x_m^2}$$

qoida bilan bitta haqiqiy u sonini mos qo'ysin. Bu holda $M \subset R^m$ to'plamda aniqlangan

$$u = \sqrt{1 - x_1^2 - x_2^2 - \dots - x_m^2}$$

funksiya hosil bo'ladi.

Aytaylik, $u = f(x_1, x_2, \dots, x_m)$ funksiya (ko'p hollarda bu funksiyani $u = f(x)$ kabi yozamiz) $E \subset R^m$ to'plamda berilgan bo'lsin. $x^0 = (x_1^0, x_2^0, \dots, x_m^0) \in E$ nuqtaga mos keluvchi u_0 son $u = f(x)$ funksiyaning x^0 nuqtadagi xususiy qiymati deyiladi: .

Berilgan funksiyaning barcha xususiy qiymatlaridan iborat ushbu

$$\{u = f(x) : x \in E\} \quad (1)$$

sonlar to'plami $u = f(x)$ funksiya qiymatlari to'plami deyiladi. Agar (1) to'plam chegaralangan bo'lsa, $u = f(x) = f(x_1, x_2, \dots, x_m)$ funksiya E to'plamda chegaralangan deyiladi.

R^{m+1} fazodagi ushbu

$$\{(x, f(x)) : x = (x_1, x_2, \dots, x_m) \in R^m, f(x) \in R\}$$

to'plam ko'p o'zgaruvchili $u = f(x_1, x_2, \dots, x_m)$ funksiyaning grafigi deyiladi.

$$\begin{aligned} \lim f(x_1, x_2, \dots, x_m) &= A \\ x_1 &\rightarrow x_1^0 \\ x_2 &\rightarrow x_2^0 \\ &\dots\dots\dots \\ x_m &\rightarrow x_m^0 \end{aligned}$$

kabi belgilanadi.

Eslatma. Agar

$$\begin{aligned} \{x^{(n)}\}, \quad (x^{(n)} \in E, x^{(n)} \neq x^0, n = 1, 2, \dots), \\ \{y^{(n)}\}, \quad (y^{(n)} \in E, y^{(n)} \neq x^0, n = 1, 2, \dots) \end{aligned}$$

ketma-ketliklar uchun $n \rightarrow \infty$ da

$$x^{(n)} \rightarrow x^0, \quad y^{(n)} \rightarrow x^0$$

bo'lib,

$$f(x^{(n)}) \rightarrow A, \quad f(y^{(n)}) \rightarrow B, \quad A \neq B$$

bo'lsa, $f(x)$ funksiya x^0 nuqtada limitga ega bo'lmaydi.

3- ta'rif. (Koshi ta'rif.) Agar $\forall \varepsilon > 0$ son olinganda ham shunday $\delta = \delta(\varepsilon) > 0$ topilsaki, $0 < \rho(x, x^0) < \varepsilon$ tengsizlikni qanoatlantiruvchi $\forall x \in E$ ($E \subset R^m$) da

$$|f(x) - A| < \varepsilon$$

tengsizlik bajarilsa, A son $f(x)$ funksiyaning x^0 nuqtadagi limiti (*karrali limiti*) deyiladi.

Bu ta'rifni qisqacha qilib quyidagicha ham aytsa bo'ladi. Agar

$$\forall \varepsilon > 0, \exists \delta > 0, \forall x \in E \cap (U_\delta(x^0) \setminus \{x^0\}): |f(x) - A| < \varepsilon$$

bo'lsa, A son $f(x)$ funksiyaning x^0 nuqtadagi limiti deyiladi.

3°. Funksiya limitining mavjudligi. Faraz qilaylik, $f(x) = f(x_1, x_2, \dots, x_m)$ funksiya $E \in R^m$ to'plamda berilgan bo'lib, $x^0 = (x_1^0, x_2^0, \dots, x_m^0)$ nuqta E to'plamning limit nuqtasi bo'lsin.

1- teorema. (Koshi teoremasi.) $f(x)$ funksiya x^0 nuqtada limitga ega bo'lishi uchun $\forall \varepsilon > 0$ son olinganda ham shunday $\delta > 0$ son topilib,

$\forall x' \in E \cap (U_\delta(x^0) \setminus \{x^0\}), \forall x'' \in E \cap (U_\delta(x^0) \setminus \{x^0\})$
nuqtalarda

$$|f(x'') - f(x')| < \varepsilon$$

tengsizlikning bajarilishi zarur va yetarli.

◀ **Zarurligi.** Aytaylik, $f(x)$ funksiya x^0 nuqtada A limitga ega bo'lsin:

$$\lim_{x \rightarrow x^0} f(x) = A.$$

Limit ta'rifiga ko'ra,

$$\forall \varepsilon > 0, \exists \delta > 0, \forall x \in E \cap (U_\delta(x^0) \setminus \{x^0\}):$$

$$|f(x) - A| < \frac{\varepsilon}{2}$$

bo'ladi. Jumladan,

$$x' \in E \cap (U_\delta(x^0) \setminus \{x^0\}), x'' \in E \cap (U_\delta(x^0) \setminus \{x^0\}):$$

nuqtalar uchun

$$|f(x') - A| < \frac{\varepsilon}{2}, \quad |f(x'') - A| < \frac{\varepsilon}{2}$$

bo'ladi.

Keyingi tengsizliklardan

$$|f(x'') - f(x')| \leq |f(x') - A| + |f(x'') - A| < \varepsilon$$

bo'lishi kelib chiqadi.

Yetarliligi. Aytaylik, $\forall \varepsilon > 0$ son olinganda ham shunday $\delta > 0$ son topiladiki, bunda

$$\forall x' \in E \cap (U_\delta(x^0) \setminus \{x^0\}), \forall x'' \in E \cap (U_\delta(x^0) \setminus \{x^0\})$$

nuqtalar uchun

$$|f(x'') - f(x')| < \varepsilon$$

tengsizlik bajariladi.

x^0 nuqtaga intiluvchi ikkita $\{x^{(n)}\}, \{y^{(n)}\}$ ketma-ketliklarni olamiz: $n \rightarrow \infty$ da

$$x^{(n)} \rightarrow x^0, \quad (x^{(n)} \in E, \quad x^{(n)} \neq x^0, \quad n = 1, 2, \dots),$$

$$y^{(n)} \rightarrow x^0, \quad (y^{(n)} \in E, \quad y^{(n)} \neq x^0, \quad n = 1, 2, \dots).$$

Bu ketma-ketliklar hadlaridan foydalanib, ushbu

$$x^{(1)}, y^{(1)}, x^{(2)}, y^{(2)}, \dots, x^{(n)}, y^{(n)}, \dots$$

ketma-ketlikni hosil qilamiz. Uni $\{z^{(n)}\}$ ketma-ketlik deylik. Ravshanki, bu ketma-ketlikning ham limiti x^0 bo'ladi: $n \rightarrow \infty$ da

$$z^{(n)} \rightarrow x^0, \quad (z^{(n)} \in E, \quad z^{(n)} \neq x^0, \quad n = 1, 2, \dots),$$

Limit ta'rifiga binoan yuqoridagi $\delta > 0$ songa ko'ra shunday $n_0 \in N$ topiladiki, $\forall n > n^0, \forall m > n^0$ da

$$z^{(n)} \in E \cap (U_\delta(x^0) \setminus \{x^0\}),$$

$$z^{(m)} \in E \cap (U_\delta(x^0) \setminus \{x^0\})$$

bo'ladi.

Teoremaning shartidan

$$|f(z^{(n)}) - f(z^{(m)})| < \varepsilon$$

tengsizlikning bajarilishi kelib chiqadi. Demak, $\{f(z^{(n)})\}$ sonlar ketma-ketligi fundamental ketma-ketlik bo'ladi. Binobarin, u yaqinlashuvchi:

$$n \rightarrow \infty \text{ da } f\{z^{(n)}\} \rightarrow A.$$

U holda $n \rightarrow \infty$ da

$$f(x^{(n)}) \rightarrow A, \quad f(y^{(n)}) \rightarrow A$$

bo'lib, funksiya limitining Geyne ta'rifiga ko'ra

$$\lim_{x \rightarrow x^0} f(x) = A$$

bo'ladi. ►

4°. Takroriy limitlar. Faraz qilaylik, $f(x) = f(x_1, x_2, \dots, x_m)$ funksiya $E \in R^m$ to'plamda berilgan bo'lib, $x^0 = (x_1^0, x_2^0, \dots, x_m^0) \in R^m$ shu E to'plamning limit nuqtasi bo'lsin.

m ta x_1, x_2, \dots, x_m o'zgaruvchilarga bog'liq bo'lgan $f(x_1, \dots, x_m)$ funksiyada x_2, x_3, \dots, x_m o'zgaruvchilar tayinlansa, ravshanki, u bitta x_1 o'zgaruvchining funksiyasiga aylanadi. Aytaylik, bu funksiya $x_1 \rightarrow x_1^0$ da limitga ega bo'lsin:

$$\lim_{x_1 \rightarrow x_1^0} f(x_1, x_2, \dots, x_m) = \varphi_1(x_2, x_3, \dots, x_m).$$

Endi $\varphi_1(x_2, x_3, \dots, x_m)$ funksiyada x_3, x_4, \dots, x_m o'zgaruvchilar tayinlanib, so'ngra $x_2 \rightarrow x_2^0$ limitga o'tilsa,

$$\lim_{x_2 \rightarrow x_2^0} \varphi_1(x_2, x_3, \dots, x_m) = \varphi_2(x_3, x_4, \dots, x_m)$$

bo'lib, berilgan funksiyaning

$$\lim_{x_2 \rightarrow x_2^0} \lim_{x_1 \rightarrow x_1^0} f(x_1, x_2, \dots, x_m)$$

limiti hosil bo'ladi.

Xuddi shunga o'xshash $f(x_1, x_2, \dots, x_m)$ funksiyaning

$$x_{i_1}, x_{i_2}, \dots, x_{i_k}$$

o'zgaruvchilari mos ravishda $x_{i_1}^0, x_{i_2}^0, \dots, x_{i_k}^0$ larga intilgandagi limiti

$$\lim_{x_{i_k} \rightarrow x_{i_k}^0} \dots \lim_{x_{i_1} \rightarrow x_{i_1}^0} f(x_1, x_2, \dots, x_m)$$

ni ham qarash mumkin.

Odatda, bu limitlar $f(x_1, x_2, \dots, x_m)$ funksiyaning takroriy limitlari deyiladi. $f(x_1, x_2, \dots, x_m)$ funksiya argumentlari x_1, x_2, \dots, x_m lar mos ravishda $x_1^0, x_2^0, \dots, x_m^0$ sonlarga turli tartibda intilganda funksiyaning turli takroriy limitlari hosil bo'ladi.

Ko'p o'zgaruvchili funksiyaning limiti (karrali limiti) hamda uning takroriy limitlari turlicha munosabatda bo'ladi. Ular haqida xususiy holda, keyingi bandda bayon etamiz.

5°. Xususiy hollar. $m = 1$ bo'lganda bitta o'zgaruvchiga bog'liq bo'lgan R fazodagi biror to'plamda aniqlangan $u = f(x)$ funksiyaga ega bo'lamiz. Bu funksiya va uning limiti 11- va 12- ma'ruzalarda o'rganilgan va to'liq ma'lumotlar keltirilgan.

$m = 2$ bo'lganda R^2 fazodagi (tekislikdagi) biror to'plamda aniqlangan ikki o'zgaruvchiga bog'liq bo'lgan $u = f(x, y)$ funksiyaga ega bo'lamiz. Masalan,

$$u = \frac{\ln(x^2 + y^2 - 1)}{\sqrt{4 - x^2 - y^2}}.$$

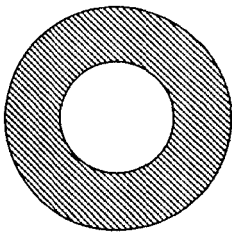

24- chizma.

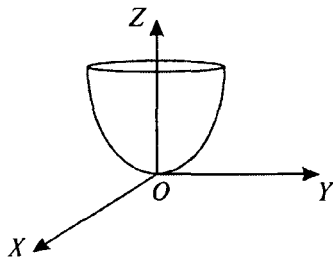

25- chizma.

Bu funksiyaning aniqlanish to'plami tekislikning ushbu

$$x^2 + y^2 - 1 > 0,$$

$$4 - x^2 - y^2 > 0$$

sistemani qanoatlantiradigan nuqtalar to'plami 24- chizmada tasvirlangan halqani ifodalaydi:

Ikki o'zgaruvchiga bog'liq bo'lgan $u = f(x, y)$ funksiyaning grafigi umuman R^3 fazoda (biz yashab turgan fazoda) sirtini ifodalaydi. Masalan, ushbu

$$u = x^2 + y^2$$

funksiyaning grafigi R^3 fazoda 25- chizmada tasvirlangan aylanma paraboloid bo'ladi.

Aytaylik, $f(x, y)$ funksiya $E \subset R^2$ to'plamda berilgan bo'lib, $(x_0, y_0) \in R^2$ nuqta E ning limit nuqtasi bo'lsin. Bu ikki o'zgaruvchili funksiya limiti ta'riflari quyidagicha bo'ladi:

Agar: 1) $\forall n \in N$ da $(x_n, y_n) \in E$, $(x_n, y_n) \neq (x_0, y_0)$,

2) $n \rightarrow \infty$ da $(x_n, y_n) \rightarrow (x_0, y_0)$

shartni qanoatlantiruvchi ixtiyoriy $\{(x_n, y_n)\}$ nuqtalar ketma-ketligi uchun

$$n \rightarrow \infty \text{ da } f(x_n, y_n) \rightarrow A$$

bo'lsa, A son funksiyaning (x_0, y_0) nuqtadagi limiti (karrali limiti) deyiladi va

$$\lim_{(x,y) \rightarrow (x_0,y_0)} f(x,y) = A \text{ yoki } \lim_{\substack{x \rightarrow x_0 \\ y \rightarrow y_0}} f(x,y) = A$$

kabi belgilanadi.

Agar $\forall \varepsilon > 0$ olinganda ham shunday $\delta > 0$ topilsaki, $0 < \rho((x, y), (x_0, y_0)) < \delta$ tengsizlikni qanoatlantiruvchi $\forall (x, y) \in E$ da

$$|f(x, y) - A| < \varepsilon$$

tengsizlik bajarilsa, A son $f(x, y)$ funksiyaning (x_0, y_0) nuqtadagi limiti (karrali limiti) deyiladi.

Berilgan funksiyaning ikkita takroriy limitlari:

$$\lim_{x \rightarrow x_0} \lim_{y \rightarrow y_0} f(x, y), \quad \lim_{y \rightarrow y_0} \lim_{x \rightarrow x_0} f(x, y)$$

bo'lishi mumkin.

1- misol. Ushbu

$$f(x, y) = \begin{cases} \frac{xy}{\sqrt{x^2 + y^2}}, & \text{agar } x^2 + y^2 \neq 0 \text{ bo'lsa,} \\ 0, & \text{agar } x^2 + y^2 = 0 \text{ bo'lsa} \end{cases}$$

funksiyaning $(x, y) \rightarrow (0, 0)$ dagi limiti 0 bo'lishi ko'rsatilsin.

◀ Koshi ta'rifidan foydalanib topamiz:

$\forall \varepsilon > 0$ son uchun $\delta = 2\varepsilon$ deyilsa,

$$0 < \rho((x, y), (0, 0)) < \delta$$

tengsizlikni qanoatlantiruvchi $\forall (x, y) \in R^2$ da

$$|f(x, y) - 0| = \left| \frac{xy}{\sqrt{x^2 + y^2}} \right| \leq \frac{1}{2} \sqrt{x^2 + y^2} = \frac{1}{2} \rho((x, y), (0, 0)) < \frac{1}{2} \delta = \varepsilon$$

bo'ladi. Demak,

$$\lim_{\substack{x \rightarrow 0 \\ y \rightarrow 0}} f(x, y) = 0. \quad \blacktriangleright$$

2- misol. Ushbu

$$f(x, y) = \frac{x^2 y^2}{x^2 y^2 + (x - y)^2}$$

funksiyaning $(0, 0)$ nuqtada limiti mavjud emasligi ko'rsatilsin.

◀ Ravshanki, bu funksiya

$$R^2 \setminus \{(0, 0)\}$$

to'plamda aniqlangan va $(0, 0)$ nuqta shu to'plamning limit nuqtasi.

$(0, 0)$ nuqtaga intiluvchi $\left\{\left(\frac{1}{n}, \frac{1}{n}\right)\right\}$, $\left\{\left(\frac{1}{n}, -\frac{1}{n}\right)\right\}$ ketma-ketliklarni

olaylik:

$$\left(\frac{1}{n}, \frac{1}{n}\right) \rightarrow (0, 0), \quad \left(\frac{1}{n}, -\frac{1}{n}\right) \rightarrow (0, 0).$$

$\left(\frac{1}{n}, \frac{1}{n}\right)$ hamda $\left(\frac{1}{n}, -\frac{1}{n}\right)$ nuqtalarda ($n=1, 2, 3$) berilgan funksiyaning qiymatlari

$$f\left(\frac{1}{n}, \frac{1}{n}\right) = 1, \quad f\left(\frac{1}{n}, -\frac{1}{n}\right) = \frac{1}{4n^2 + 1}, \quad (n=1, 2, 3)$$

bo'lib, $f\left(\frac{1}{n}, \frac{1}{n}\right) \rightarrow 1$, $f\left(\frac{1}{n}, -\frac{1}{n}\right) \rightarrow 0$

bo'ladi. Funksiya limitining Geyne ta'rifidan foydalanib, berilgan funksiyaning $(x, y) \rightarrow (0, 0)$ da limitga ega emasligini topamiz. ►

3- misol. Ushbu

$$f(x, y) = \begin{cases} \frac{xy}{\sqrt{x^2 + y^2}}, & \text{agar } x^2 + y^2 \neq 0 \text{ bo'lsa,} \\ 0, & \text{agar } x^2 + y^2 = 0 \text{ bo'lsa} \end{cases}$$

funksiyaning $(0, 0)$ da takroriy limitlari topilsin.

◀ Berilgan funksiyaning takroriy limitlarini topamiz:

$$\lim_{x \rightarrow 0} f(x, y) = \lim_{x \rightarrow 0} \frac{xy}{\sqrt{x^2 + y^2}} = 0, \quad \lim_{y \rightarrow 0} \lim_{x \rightarrow 0} f(x, y) = 0,$$

$$\lim_{y \rightarrow 0} f(x, y) = \lim_{y \rightarrow 0} \frac{xy}{\sqrt{x^2 + y^2}} = 0, \quad \lim_{x \rightarrow 0} \lim_{y \rightarrow 0} f(x, y) = 0.$$

Demak, berilgan funksiyaning $(0, 0)$ nuqtadagi takroriy limitlari bir-biriga teng bo'lib, ular 0 ga teng. ►

4- misol. Ushbu $f(x, y) = \begin{cases} \frac{2x-y}{\sqrt{x+3y}}, & \text{agar } x+3y \neq 0 \text{ bo'lsa,} \\ 0, & \text{agar } x+3y = 0 \text{ bo'lsa} \end{cases}$

funksiyaning $(0, 0)$ nuqtadagi takroriy limitlari topilsin.

◀ Berilgan funktsiyaning takroriy limitlari quyidagicha bo'ladi:

$$\lim_{x \rightarrow 0} \frac{2x-y}{x+3y} = -\frac{1}{3}, \quad \lim_{y \rightarrow 0} \lim_{x \rightarrow 0} \frac{2x-y}{x+3y} = -\frac{1}{3};$$

$$\lim_{y \rightarrow 0} \frac{2x-y}{x+3y} = 2, \quad \lim_{x \rightarrow 0} \lim_{y \rightarrow 0} \frac{2x-y}{x+3y} = 2.$$

Ayni paytda, berilgan funktsiya $(x, y) \rightarrow (0, 0)$ da limitga (karrali limitga) ega bo'lmaydi, chunki

$$\left(\frac{1}{n}, \frac{1}{n}\right) \rightarrow (0, 0), \quad \left(\frac{5}{n}, \frac{4}{n}\right) \rightarrow (0, 0)$$

ketma-ketliklar uchun

$$f\left(\frac{1}{n}, \frac{1}{n}\right) = \frac{1}{4} \rightarrow \frac{1}{4}, \quad f\left(\frac{5}{n}, \frac{4}{n}\right) = \frac{6}{17} \rightarrow \frac{6}{17}$$

bo'lib, ular bir-biriga teng emas. ▶

5- misol. Ushbu

$$f(x, y) = \begin{cases} x + y \sin \frac{1}{x}, & \text{agar } x \neq 0 \text{ bo'lsa,} \\ 0, & \text{agar } x = 0 \text{ bo'lsa} \end{cases}$$

funktsiyaning $(0, 0)$ nuqtadagi takroriy limitlari topilsin.

◀ Bu funktsiya uchun

$$\lim_{y \rightarrow 0} f(x, y) = x, \quad \lim_{x \rightarrow 0} \lim_{y \rightarrow 0} f(x, y) = 0$$

bo'lib,

$$\lim_{y \rightarrow 0} \lim_{x \rightarrow 0} f(x, y)$$

esa mavjud bo'lmaydi.

Ayni paytda, $(x, y) \rightarrow (0, 0)$ da berilgan funktsiyaning limiti (karrali limiti) mavjud bo'ladi, chunki

$$|f(x, y) - 0| = \left| x + y \sin \frac{1}{x} \right| \leq |x| + |y|, \quad (x \neq 0)$$

bo'lib,

$$\lim_{\substack{x \rightarrow 0 \\ y \rightarrow 0}} f(x, y) = 0$$

bo'ladi. ▶

Faraz qilaylik, $f(x,y)$ funksiya R^2 fazodagi

$$E = \{(x, y) \in R^2 : |x - x_0| < a, |y - y_0| < b\}$$

to'plamda berilgan bo'lsin.

2- teorema. Agar

1) $(x, y) \rightarrow (x_0, y_0)$ da $f(x,y)$ funksiyaning limiti (karrali limiti) mavjud va

$$\lim_{\substack{x \rightarrow x_0 \\ y \rightarrow y_0}} f(x, y) = A;$$

2) har bir tayinlangan x da

$$\lim_{y \rightarrow y_0} f(x, y) = \varphi(x) \quad (2)$$

mavjud bo'lsa, u holda

$$\lim_{x \rightarrow x_0} \lim_{y \rightarrow y_0} f(x, y)$$

takroriy limit mavjud va

$$\lim_{x \rightarrow x_0} \lim_{y \rightarrow y_0} f(x, y) = A$$

bo'ladi.

◀ Aytaylik,
$$\lim_{\substack{x \rightarrow x_0 \\ y \rightarrow y_0}} f(x, y) = A$$

bo'lsin. Limit ta'rifiga binoan, $\forall \varepsilon > 0$ olinganda ham shunday $\delta > 0$ topiladiki, ushbu

$$\{(x, y) \in R^2 : |x - x_0| < \delta, |y - y_0| < \delta\} \subset E$$

to'plamning barcha (x, y) nuqtalari uchun

$$|f(x, y) - A| < \varepsilon$$

tengsizlik bajariladi. Keyingi tengsizlikdan, $y \rightarrow y_0$ da limitga o'tib topamiz:

$$|\varphi(x) - A| \leq \varepsilon.$$

Demak,
$$\lim_{x \rightarrow x_0} \varphi(x) = A. \quad (3)$$

(2) va (3) munosabatlardan

$$\lim_{x \rightarrow x_0} \lim_{y \rightarrow y_0} f(x, y) = A$$

bo'lishi kelib chiqadi. ►

Xuddi shunga o'xshash quyidagi teorema isbotlanadi.

3- teorema. Agar:

1) $(x, y) \rightarrow (x_0, y_0)$ da $f(x, y)$ funksiyaning limiti (karrali limiti) mavjud va

$$\lim_{\substack{x \rightarrow x_0 \\ y \rightarrow y_0}} f(x, y) = A;$$

2) har bir tayinlangan y da

$$\lim_{y \rightarrow y_0} f(x, y) = \varphi(y)$$

mavjud bo'lsa, u holda

$$\lim_{x \rightarrow x_0} \lim_{y \rightarrow y_0} f(x, y)$$

takroriy limit mavjud va

$$\lim_{x \rightarrow x_0} \lim_{y \rightarrow y_0} f(x, y) = A$$

bo'ladi.

Natija. Agar $f(x, y)$ funksiya uchun bir vaqtda yuqoridagi 2- va 3- teoremlarning shartlari bajarilsa, u holda

$$\lim_{\substack{x \rightarrow x_0 \\ y \rightarrow y_0}} f(x, y) = \lim_{x \rightarrow x_0} \lim_{y \rightarrow y_0} f(x, y) = \lim_{y \rightarrow y_0} \lim_{x \rightarrow x_0} f(x, y)$$

bo'ladi.

Mashqlar

1. Funksiya limiti Geyne va Koshi ta'riflarining ekvivalentligi ko'rsatilsin.

2. Limitga ega bo'lgan funksiyalarning xossalari keltirilsin.

3. Ushbu

$$\lim_{\substack{x \rightarrow +\infty \\ y \rightarrow +\infty}} f(x, y) = A$$

limit ta'riflansin.

4. Ushbu

$$\lim_{\substack{x \rightarrow +\infty \\ y \rightarrow +\infty}} (x^2, y^2) e^{-(x+y)}$$

limit hisoblansin.

58- ma'ruza

Ko'p o'zgaruvchili funktsiyaning uzluksizligi. Tekis uzluksizlik. Kantor teoremasi

1°. Ko'p o'zgaruvchili funktsiya uzluksizligi tushunchasi. Faraz qilaylik, $f(x) = f(x_1, x_2, \dots, x_m)$ funktsiya R^m fazodagi E to'plamda berilgan bo'lib, $x^0 \in E$ nuqta E to'plamning limit nuqtasi bo'lsin.

1- ta'rif. Agar

$$\lim_{x \rightarrow x^0} f(x) = f(x^0) \quad (1)$$

bo'lsa, $f(x)$ funktsiya x^0 nuqtada uzluksiz deyiladi.

2- ta'rif. (Geyne ta'rifi.) Agar:

1) $\forall n \in N$ da $x^{(n)} \in E$;

2) $n \rightarrow \infty$ da $x^{(n)} \rightarrow x^0$

shartlarni qanoatlantiruvchi ixtiyoriy $\{x^{(n)}\}$ ketma-ketlik uchun

$$n \rightarrow \infty \text{ da } f(x^{(n)}) \rightarrow f(x^0)$$

bo'lsa, $f(x)$ funktsiya x^0 nuqtada uzluksiz deyiladi.

3- ta'rif. (Koshi ta'rifi.). Agar

$$\forall \varepsilon > 0, \exists \delta > 0, \forall x \in E \cap U_\delta(x^0), |f(x) - f(x^0)| < \varepsilon$$

bo'lsa, $f(x)$ funktsiya x^0 nuqtada uzluksiz deyiladi.

Umuman, $u = f(x)$ funktsiyaning $x^0 \in E$ nuqtadagi uzluksizligi quyidagini anglatadi:

$$\forall \varepsilon > 0, \exists \delta > 0, \forall x \in E \cap U_\delta(x^0), f(x) \in U_\varepsilon(f(x^0)).$$

Odatda, ushbu

$$\Delta u = f(x) - f(x^0), \quad (x = (x_1, x_2, \dots, x_m), \quad x^0 = (x_1^0, \dots, x_m^0))$$

ayirma $u = f(x)$ funktsiyaning x^0 nuqtadagi orttirmasi (to'liq orttirmasi) deyiladi.

Agar

$$\Delta x_1 = x_1 - x_1^0, \quad \Delta x_2 = x_2 - x_2^0, \quad \dots, \quad \Delta x_m = x_m - x_m^0$$

deyilsa, u holda

$$\Delta u = f(x_1^0 + \Delta x_1, x_2^0 + \Delta x_2, \dots, x_m^0 + \Delta x_m) - f(x_1^0, x_2^0, \dots, x_m^0)$$

bo'ladi. Yuqoridagi (1) munosabatdan foydalanib quyidagi tasdiqni ayta olamiz:

$f(x)$ funksiya x^0 nuqtada uzluksiz bo'lishi uchun

$$\lim_{x \rightarrow x_0} \Delta u = 0, \text{ ya'ni } \begin{cases} \lim_{\Delta x_1 \rightarrow 0} \Delta u = 0 \\ \lim_{\Delta x_2 \rightarrow 0} \Delta u = 0 \\ \dots \dots \dots \\ \lim_{\Delta x_m \rightarrow 0} \Delta u = 0 \end{cases}$$

bo'lishi zarur va yetarli.

Yuqoridagi ta'riflar ekvivalent ta'riflar bo'ladi.

Agar (1) munosabat bajarilmasa, $f(x)$ funksiya x^0 nuqtada uzilishga ega deyiladi.

4- ta'rif. Agar $f(x)$ funksiya E to'plamning har bir nuqtasida uzluksiz bo'lsa, funksiya shu E to'plamda uzluksiz deyiladi.

Ko'p o'zgaruvchili funksiyalarda funksiyaning nuqtadagi to'liq orttirmasi tushunchasi bilan bir qatorda uning xususiy orttirmalari tushunchalari ham kiritiladi.

Ushbu

$$\begin{aligned} \Delta_{x_1} u &= f(x_1^0 + \Delta x_1, x_2^0, x_3^0, \dots, x_m^0) - f(x_1^0, x_2^0, \dots, x_m^0), \\ \Delta_{x_2} u &= f(x_1^0, x_2^0 + \Delta x_2, x_3^0, \dots, x_m^0) - f(x_1^0, x_2^0, \dots, x_m^0), \\ &\dots \dots \dots \\ \Delta_{x_m} u &= f(x_1^0, x_2^0, \dots, x_{m-1}^0, x_m^0 + \Delta x_m) - f(x_1^0, x_2^0, \dots, x_m^0) \end{aligned}$$

ayirmalar mos ravishda $f(x)$ funksiyaning x^0 nuqtadagi x_1, x_2, \dots, x_m o'zgaruvchilar bo'yicha xususiy orttirmalari deyiladi. Ravshanki,

$$\lim_{x \rightarrow x^0} \Delta u = 0 \Rightarrow \begin{cases} \lim_{\Delta x_1 \rightarrow 0} \Delta_{x_1} u = 0, \\ \lim_{\Delta x_2 \rightarrow 0} \Delta_{x_2} u = 0, \\ \dots \dots \dots \\ \lim_{\Delta x_m \rightarrow 0} \Delta_{x_m} u = 0 \end{cases}$$

bo'ladi. Biroq, $\Delta_{x_k} \rightarrow 0$ da $\Delta_{x_k} u \rightarrow 0$ ($k = 1, 2, \dots, m$) bo'lishidan

$$\lim_{x \rightarrow x_0} \Delta u = 0$$

bo'lishi har doim kelib chiqavermaydi (bunga misol keyingi badda keltiriladi).

◀ Shartga ko'ra $f(x)$ funksiya x^0 nuqtada uzluksiz. U holda ta'rifga binoan

$$\forall \varepsilon > 0, \exists \delta > 0, \forall x \in E \cap U_\delta(x^0) : |f(x) - f(x^0)| < \varepsilon \quad (3)$$

bo'ladi. Ravshanki.

$$\forall x \in E \cap U_\delta(x^0) \Rightarrow |x_i - x_i^0| < \delta, \quad (i = 1, 2, \dots, m) \quad (4)$$

bo'ladi. Shartga ko'ra $\varphi_i(t)$ ($i = 1, 2, \dots, m$) funksiyalar t^0 nuqtada uzluksiz. Ta'rifga binoan $\delta > 0$ uchun shunday $\delta_i > 0$ topiladiki, bunda

$$\forall t \in M \cap U_{\delta_i}(t^0) : |\varphi_i(t) - \varphi_i(t^0)| < \delta$$

bo'ladi, $i = 1, 2, \dots, m$.

Endi $\min\{\delta_1, \delta_2, \dots, \delta_m\} = \delta$ deb olamiz. U holda $\forall t \in M \cap U_\delta(t^0)$ va barcha $i = 1, 2, \dots, m$ lar uchun

$$|\varphi_i(t) - \varphi_i(t^0)| < \delta, \text{ ya'ni } |x_i - x_i^0| < \delta$$

bo'ladi. (3) va (4) munosabatlardan $\forall t \in M \cap U_\delta(t^0)$ uchun

$$|f(x(t)) - f(x(t_0))| < \varepsilon$$

bo'lishi kelib chiqadi. Demak, murakkab $f(x(t))$ funksiya t^0 nuqtada uzluksiz. ▶

3°. To'plamda uzluksiz bo'lgan funksiyalarning xossalari. Endi to'plamda uzluksiz bo'lgan funksiyalarning xossalarini keltiramiz.

2- teorema. Agar $f(x)$ funksiya chegaralangan yopiq $E \subset R^m$ to'plamda uzluksiz bo'lsa, funksiya E da chegaralangan bo'ladi.

◀ Aytaylik, funksiya shu E to'plamda chegaralanmagan bo'lsin. U holda

$$\forall n \in N, \exists x^{(n)} \in E : |f(x^{(n)})| \geq n, \quad (n = 1, 2, \dots)$$

bo'ladi. Ravshanki, $\{x^{(n)}\}$ ketma-ketlik chegaralangan. Bolsano–Veyershtross teoremasiga ko'ra yaqinlashuvchi

$$\{x^{(n_k)}\}, \quad (x^{(n_k)} \in E, \quad k = 1, 2, \dots)$$

qisman ketma-ketlik mavjud:

$$k \rightarrow \infty \text{ da } x^{(n_k)} \rightarrow x^0 \text{ va } x^0 \in E.$$

Ayni paytda, $f(x)$ funksiyaning E da uzluksizligidan

$$k \rightarrow \infty \text{ da } f(x^{(n_k)}) \rightarrow f(x^0)$$

bo'lishi kelib chiqadi. Bu esa

$$k \rightarrow \infty \text{ da } |f(x^{(n_k)})| \geq n_k \rightarrow +\infty$$

deyilishiga zid. Ziddiyat $f(x)$ funksiyaning E da chegaralanmagan deyilishidan kelib chiqdi. Demak, $f(x)$ funksiya E da chegaralangan. ►

3- teorema. Agar $f(x)$ funksiya chegaralangan yopiq $E \subset R^m$ to'plamda uzluksiz bo'lsa, funksiya shu to'plamda o'zining aniq yuqori hamda aniq quyi chegaralariga erishadi, ya'ni

$$\exists x^{(*)} \in E, \quad \sup_{x \in E} \{f(x)\} = f(x^{(*)}),$$

$$\exists x^{(**)} \in E, \quad \inf_{x \in E} \{f(x)\} = f(x^{(**)})$$

bo'ladi.

◀ Yuqoridagi teoreмага ko'ra $f(x)$ funksiya E to'plamda chegaralangan bo'ladi. U holda bu funksiya aniq chegaralarga ega:

$$\sup_{x \in E} \{f(x)\} = a, \quad \inf_{x \in E} \{f(x)\} = b.$$

Aniq yuqori chegara ta'rifiga ko'ra

$$\forall n \in N, \quad \exists x^{(n)} \in E : a - \frac{1}{n} < f(x^{(n)}) \leq a, \quad (n = 1, 2, \dots)$$

bo'ladi. Ravshanki, $\{x^{(n)}\}$ chegaralangan ketma-ketlik bo'lib, undan $\{x^{(n_k)}\}$ qisman ketma-ketlik ajratish mumkinki,

$$k \rightarrow \infty \text{ da } x^{(n_k)} \rightarrow x^{(*)} \text{ va } x^{(*)} \in E \quad (5)$$

bo'ladi. Berilgan funksiyaning uzluksizligidan foydalanib topamiz:

$$k \rightarrow \infty \text{ da } f(x^{(n_k)}) \rightarrow f(x^{(*)}).$$

Ayni paytda,

$$\forall n \in N \text{ da } a - \frac{1}{n_k} < f(x^{(n_k)}) \leq a$$

bo'lib, undan $k \rightarrow \infty$ da

$$f(x^{(n_k)}) \rightarrow a \quad (6)$$

bo'lishi kelib chiqadi. (5) va (6) munosabatlardan

$$f(x^{(*)}) = a = \sup \{f(x)\}, \quad (x^{(*)} \in E)$$

bo'lishini topamiz.

Xuddi shunga o'xshash

$$f(x^{(**)}) = b = \inf \{f(x)\}, \quad (x^{(**)} \in E)$$

bo'lishi isbotlanadi. ►

4- teorema. Faraz qilaylik, $f(x) = f(x_1, x_2, \dots, x_m)$ funksiya bog'lamli $E \subset R^m$ to'plamda berilgan bo'lsin.

Agar:

1) $f(x)$ funksiya E da uzluksiz,

2) $a = (a_1, a_2, \dots, a_m) \in E, \quad b = (b_1, b_2, \dots, b_m) \in E$

nuqtalarda turli ishorali qiymatlarga ega:

$$(f(a) > 0, \quad f(b) < 0 \text{ yoki } f(a) < 0, \quad f(b) > 0)$$

bo'lsa, u holda shunday $c = (c_1, c_2, \dots, c_m) \in E$ nuqta topiladiki,

$$f(c) = 0$$

bo'ladi.

◀ Aytaylik, $f(x)$ funksiya bog'lamli $E \subset R^m$ to'plamda uzluksiz bo'lib,

$$f(a) < 0, \quad f(b) > 0$$

bo'lsin.

E – bog'lamli to'plam. Binobarin, a va b nuqtalarni birlashtiruvchi va shu to'plamga tegishli sinq chiziq topiladi. Agar bu sinq chiziq uchlarini ifodalovchi nuqtalarning birida $f(x)$ funksiya nolga aylansa, teorema isbotlanadi.

Agar sinq chiziq uchlarida $f(x)$ funksiya nolga aylanmasa, u holda sinq chiziqning shunday kesmasi topiladiki, uning bir uchi $a' = (a'_1, a'_2, \dots, a'_m)$ da $f(a') < 0$, ikkinchi uchi $b' = (b'_1, b'_2, \dots, b'_m)$ da $f(b') > 0$ bo'ladi.

Endi $f(x) = f(x_1, x_2, \dots, x_m)$ ni shu kesma

$$k = \{(x_1, x_2, \dots, x_m) \in R^m : x_1 = a'_1 + t(b'_1 - a'_1), \\ x_2 = a'_2 + t(b'_2 - a'_2), \dots, x_m = a'_m + t(b'_m - a'_m)\}$$

$(0 \leq t \leq 1)$ da qaraymiz. U holda

$f(a'_1 + t(b'_1 - a'_1), a'_2 + t(b'_2 - a'_2), \dots, a'_m + t(b'_m - a'_m)) = F(t)$
 bo'lib, bitta t o'zgaruvchiga bog'liq funksiya hosil bo'ladi. Bu funksiya $[0, 1]$ segmentda uzluksiz va

$$F(0) = f(a') < 0, \quad F(1) = f(b') > 0$$

bo'ladi. U holda 16- ma'ruzada keltirilgan teorema ko'ra shunday $t_0 \in (0, 1)$ nuqta topiladiki, bunda

$$F(t_0) = 0,$$

ya'ni

$f(a'_1 + t_0(b'_1 - a'_1), a'_2 + t_0(b'_2 - a'_2), \dots, a'_m + t_0(b'_m - a'_m)) = 0$
 bo'ladi. Agar

$c = a'_1 + t_0(b'_1 - a'_1), c_2 = a'_2 + t_0(b'_2 - a'_2), \dots, c_m = a'_m + t_0(b'_m - a'_m)$
 deyilsa, u holda $c = (c_1, c_2, \dots, c_m) \in E$ nuqtada

$$f(c) = 0$$

bo'ladi. ►

5- teorema. Faraz qilaylik, $f(x)$ funksiya bog'lamli $E \subset R^m$ to'plamda berilgan bo'lsin. Agar:

1) $f(x)$ funksiya E da uzluksiz,

2) $a \in E, b \in E$ nuqtalarda $f(a) = A, f(b) = B$

qiymatlarga ega va $A \neq B$ bo'lsa, u holda A bilan B orasida har qanday C son olinsa ham, shunday $c \in E$ nuqta topiladiki, bunda

$$f(c) = C$$

bo'ladi.

◀ Bu teorema yuqoridagi 4- teorema kabi isbotlanadi. ►

4°. Funksiyaning tekis uzluksizligi. Kantor teoremasi. Aytaylik, $f(x)$ funksiya $E \subset R^m$ to'plamda berilgan bo'lsin.

5- ta'rif. Agar $\forall \epsilon > 0$ son olinganda ham shunday $\delta = \delta(\epsilon) > 0$ son topilsaki,

$$\rho(x', x'') < \delta$$

tengsizlikni qanoatlantiruvchi ixtiyoriy $x' \in E, x'' \in E$ uchun

$$|f(x'') - f(x')| < \epsilon$$

tengsizlik bajarilsa, $f(x)$ funksiya E to'plamda tekis uzluksiz deyiladi.

Agar $f(x)$ funksiya E to'plamda tekis uzluksiz bo'lsa, u shu to'plamda uzluksiz bo'ladi.

◀ Haqiqatan ham, yuqoridagi ta'rifda x'' nuqta sifatida $x^0 \in E$ olinsa, funksiyaning x^0 nuqtada uzluksizligi, binobarin, E to'plamda uzluksizligi kelib chiqadi. ▶

$f(x)$ funksiyaning $E \subset R^m$ to'plamda tekis uzluksiz emasligi quyidagicha:

$\exists \varepsilon_0 > 0, \forall \delta > 0, \exists x' \in E, \exists x'' \in E, \rho(x', x'') < \delta : |f(x'') - f(x')| \geq \varepsilon_0$
ko'rinishda bo'ladi.

6- teorema. (Kantor teoremasi.) Agar $f(x)$ funksiya chegaralangan yopiq $E \subset R^m$ to'plamda uzluksiz bo'lsa, funksiya shu to'plamda tekis uzluksiz bo'ladi.

◀ Faraz qilaylik, $f(x)$ funksiya chegaralangan yopiq $E \subset R^m$ to'plamda uzluksiz bo'lib, u shu to'plamda tekis uzluksiz bo'lmasin. U holda biror $\varepsilon_0 > 0$ son va $\forall n \in N$ uchun E to'plamda

$$\rho(x^{(n)}, y^{(n)}) < \frac{1}{n}, \quad (n = 1, 2, 3, \dots)$$

tengsizlikni qanoatlantiruvchi shunday

$$x^{(n)} \in E, \quad y^{(n)} \in E$$

nuqtalar topiladiki, bunda

$$|f(x^{(n)}) - f(y^{(n)})| \geq \varepsilon_0$$

bo'ladi. Ravshanki,

$$\{x^{(n)}\}, \quad (x^{(n)} \in E, \quad n = 1, 2, 3, \dots)$$

ketma-ketlik chegaralangan. Undan yaqinlashuvchi qisman ketma-ketlik ajratish mumkin:

$$k \rightarrow \infty \text{ da } x^{(n_k)} \rightarrow x^0 \text{ va } x^0 \in E.$$

Masofa xossasidan foydalanib topamiz:

$$\rho(y^{(n_k)}, x^0) \leq \rho(y^{(n_k)}, x^{(n_k)}) + \rho(x^{(n_k)}, x^0) < \frac{1}{n_k} + \rho(x^{(n_k)}, x^0).$$

Keyingi munosabatdan, $k \rightarrow \infty$ da limitga o'tish bilan

$$y^{(n_k)} \rightarrow x^0$$

bo'lishini topamiz. $f(x)$ funksiya E to'plamda, jumladan, $x^0 \in E$ nuqtada uzluksiz. U holda $k \rightarrow \infty$ da

$$f(x^{(n_k)}) \rightarrow f(x^0), \quad f(y^{(n_k)}) \rightarrow f(x^0)$$

bo'lib, undan

$$f(x^{(n_k)}) - f(y^{(n_k)}) \rightarrow 0$$

bo'lishi kelib chiqadi. Bu esa

$$|f(x^{(n_k)}) - f(y^{(n_k)})| \geq \varepsilon_0$$

deb qilingan farazga ziddir. Demak, $f(x)$ funksiya E to'plamda tekis uzluksiz. ►

Aytaylik, R^m fazoda biror E to'plam berilgan bo'lsin: $E \subset R^m$. Ushbu

$$\alpha = \sup_{x' \in E, x'' \in E} \rho(x', x'')$$

miqdor E to'plamning diametri deyiladi.

6- ta'rif. $f(x)$ funksiya $E \subset R^m$ to'plamda aniqlangan bo'lsin. U holda

$$\omega(f, E) = \sup_{x' \in E, x'' \in E} \{|f(x') - f(x'')|\}$$

son $f(x)$ funksiyaning E to'plamdagi tebranishi deyiladi.

Natija. $f(x)$ funksiya chegaralangan yopiq $E \subset R^m$ to'plamda uzluksiz bo'lsa, u holda $\forall \varepsilon > 0$ son uchun shunday $\delta > 0$ son topiladiki, bunda E to'plamni diametri δ dan kichik bo'lgan E_k to'plamlarga ajratish mumkin:

$$\bigcup_k E_k = E, \quad E_k \cap E_i = \emptyset, \quad (k \neq i)$$

va har bir E_k da

$$\omega(f; E_k) \leq \varepsilon$$

bo'ladi.

◀ Natijaning shartidan $f(x)$ funksiyaning E to'plamda tekis uzluksizligi kelib chiqadi. U holda ta'rifga binoan $\forall \varepsilon > 0$ uchun shunday $\delta > 0$ topiladiki, bunda $\rho(x', x'') < \delta$ tengsizlikni qanoatlantiruvchi ixtiyoriy $x' \in E, x'' \in E$ nuqtalarda

$$|f(x'') - f(x')| < \varepsilon$$

bo'ladi.

Ravshanki, $\forall x' \in E_k, \forall x'' \in E_k$ nuqtalar uchun

$$\rho(x', x'') < \delta$$

tengsizlik bajariladi. Demak,

$$|f(x') - f(x'')| < \varepsilon.$$

Keyingi tengsizlikdan

$$\sup_{x' \in E_k, x'' \in E_k} \{|f(x') - f(x'')|\} \leq \varepsilon,$$

ya'ni

$$\omega(f; E_k) \leq \varepsilon$$

bo'lishi kelib chiqadi. ►

5°. Xususiy hollar. $m = 1$ bo'lganda $R^m = R$ va bundagi to'plamda berilgan funksiyaning uzluksizligi bir o'zgaruvchili $u = f(x)$ funksiyaning ($x \in R, u \in R$) uzluksizligi bo'lib, uning xossalari 15–17-ma'ruzalarda o'rganilgan. $m = 2$ bo'lganda $R^m = R^2$ va undan M to'plamda berilgan funksiyaning uzluksizligi, ikki o'zgaruvchili $u = f(x, y)$ funksiyaning ($(x, y) \in E \subset R^2, u \in R$) uzluksizligi bo'lib, uning $(x_0, y_0) \in E$ nuqtadagi uzluksizligi quyidagicha bo'ladi. Agar:

$$\lim_{\substack{x \rightarrow x_0 \\ y \rightarrow y_0}} f(x, y) = f(x_0, y_0)$$

bo'lsa yoki $\forall \varepsilon > 0, \exists \delta > 0, \forall (x, y) \in E \cap U_\delta((x_0, y_0))$:

$$|f(x, y) - f(x_0, y_0)| < \varepsilon$$

bo'lsa, yoki $\forall n \in N$ da $(x_n, y_n) \in E$ bo'lgan va $n \rightarrow \infty$ da $(x_n, y_n) \rightarrow (x_0, y_0)$ bo'ladigan ixtiyoriy $\{(x_n, y_n)\}$ ketma-ketlik uchun $f(x_n, y_n) \rightarrow f(x_0, y_0)$ bo'lsa, yoki

$$\lim_{\substack{\Delta x \rightarrow 0 \\ \Delta y \rightarrow 0}} f(x, y) = \lim_{\substack{\Delta x \rightarrow 0 \\ \Delta y \rightarrow 0}} [f(x_0 + \Delta x, y_0 + \Delta y) - f(x_0, y_0)] = 0$$

bo'lsa, $f(x, y)$ funksiya (x_0, y_0) nuqtada uzluksiz bo'ladi.

1- misol. Ushbu

$$f(x, y) = x + y$$

funksiyaning R^2 da uzluksiz bo'lishi ko'rsatilsin.

◀ $\forall \varepsilon > 0$ sonini olamiz. Unga ko'ra $\delta > 0$ soni $\delta = \frac{\varepsilon}{2}$ deyilsa, u holda

$$\rho((x, y), (x_0, y_0)) = \sqrt{(x - x_0)^2 + (y - y_0)^2} < \delta$$

tengsizlikni qanoatlantiruvchi $\forall(x, y) \in R^2$ nuqtalarda

$$\begin{aligned} |f(x, y) - f(x_0, y_0)| &= |x + y - (x_0 + y_0)| \leq \\ &\leq |x - x_0| + |y - y_0| \leq 2\sqrt{(x - x_0)^2} < 2\delta = \varepsilon \end{aligned}$$

bo'ladi. Bu esa ta'rifga ko'ra berilgan funktsiyaning $\forall(x_0, y_0) \in R^2$ nuqtada uzluksiz bo'lishini bildiradi. ►

Aytaylik, $f(x, y)$ funktsiya $E \subset R^2$ to'plamda berilgan bo'lib, $(x_0, y_0) \in E$ bo'lsin. Ma'lumki, bu funktsiyaning to'liq orttirmasi

$$\Delta f(x_0, y_0) = f(x_0 + \Delta x, y_0 + \Delta y) - f(x_0, y_0),$$

xususiy orttirmalari

$$\Delta_x f(x_0, y_0) = f(x_0 + \Delta x, y_0) - f(x_0, y_0),$$

$$\Delta_y f(x_0, y_0) = f(x_0, y_0 + \Delta y) - f(x_0, y_0)$$

bo'ladi ($(x_0 + \Delta x, y_0 + \Delta y) \in E, (x_0 + \Delta x, y_0) \in E, (x_0, y_0 + \Delta y) \in E$).

$$\text{Agar } \lim_{\Delta x \rightarrow 0} \Delta_x f(x_0, y_0) = 0, \left(\lim_{\Delta y \rightarrow 0} \Delta_y f(x_0, y_0) = 0 \right)$$

bo'lsa, $f(x, y)$ funktsiya (x_0, y_0) nuqtada x o'zgaruvchi bo'yicha (y o'zgaruvchi bo'yicha) uzluksiz deyiladi. Ravshanki, $f(x, y)$ funktsiya (x_0, y_0) nuqtada uzluksiz bo'lsa, funktsiya shu nuqtada har bir o'zgaruvchisi bo'yicha uzluksiz bo'ladi.

Biroq, $f(x, y)$ funktsiyaning (x_0, y_0) nuqtada har bir o'zgaruvchisi bo'yicha uzluksiz bo'lishidan uning shu nuqtada uzluksiz bo'lishi har doim ham kelib chiqavermaydi.

2- misol. Ushbu

$$f(x, y) = \begin{cases} \frac{2xy}{x^2 + y^2}, & \text{agar } x^2 + y^2 \neq 0 \text{ bo'lsa,} \\ 0, & \text{agar } x^2 + y^2 = 0 \text{ bo'lsa} \end{cases}$$

funktsiya $(0, 0)$ nuqtada uzluksizlikka tekshirilsin.

◀ Berilgan funktsiyaning $(0, 0)$ nuqtadagi xususiy orttirmalari

$$\Delta_x f(0, 0) = f(0 + \Delta x, 0) - f(0, 0) = 0,$$

$$\Delta_y f(0, 0) = f(0, 0 + \Delta y) - f(0, 0) = 0$$

bo'lib,

$$\lim_{\Delta x \rightarrow 0} \Delta_x f(0,0) = 0, \quad \lim_{\Delta y \rightarrow 0} \Delta_y f(0,0) = 0$$

bo'ladi. Demak, $f(x,y)$ funksiya $(0,0)$ nuqtada har bir o'zgaruvchisi bo'yicha uzluksiz.

Qaralayotgan funksiyaning $(0,0)$ nuqtadagi to'liq orttirmasi

$$\Delta f(0,0) = f(0 + \Delta x, 0 + \Delta y) - f(0,0) = \frac{2\Delta x \cdot \Delta y}{\Delta x^2 + \Delta y^2}$$

bo'ladi. Ushbu

$$\lim_{\substack{\Delta x \rightarrow 0 \\ \Delta y \rightarrow 0}} \Delta f(0,0)$$

limit mavjud bo'lmaydi, chunki

$$\left. \begin{array}{l} \Delta x = \frac{1}{n} \rightarrow 0 \\ \Delta y = \frac{2}{n} \rightarrow 0 \end{array} \right\} \text{ da } \Delta f(0,0) = \frac{2 \cdot \frac{1}{n} \cdot \frac{2}{n}}{\frac{1}{n^2} + \frac{4}{n^2}} = \frac{4}{5} \rightarrow \frac{4}{5},$$

$$\left. \begin{array}{l} \Delta x = \frac{1}{n} \rightarrow 0 \\ \Delta y = \frac{1}{n} \rightarrow 0 \end{array} \right\} \text{ da } \Delta f(0,0) = \frac{2 \cdot \frac{1}{n} \cdot \frac{1}{n}}{\frac{1}{n^2} + \frac{1}{n^2}} = 1 \rightarrow 1.$$

Demak, berilgan funksiya $(0,0)$ nuqtada uzluksiz bo'lmaydi. ►

3- misol. Ushbu

$$f(x,y) = \frac{1}{\sin^2 \pi x + \sin^2 \pi y}$$

funksiyaning uzilish nuqtalari topilsin.

◀ Bu funksiya R^2 to'planning

$$\sin \pi x = 0,$$

$$\sin \pi y = 0$$

sistemasini qanoatlantiruvchi (x,y) nuqtalarida uzilishga ega. Ravshan-ki, sistemaning yechimi

$$\{(x,y) \in R^2; x = n \in Z, y = m \in Z\}$$

to'plam nuqtalaridan iborat. Demak, berilgan funksiyaning uzilish nuqtalari cheksiz ko'p bo'lib, ular

$$\{(n, m) \in R^2; n \in Z, m \in Z\}$$

to'plamni tashkil etadi. ►

Mashqlar

1. Agar biror $E \subset R^m$ to'plam va $x \in R^m$ uchun

$$\rho(x, E) = \inf_{y \in E} \rho(x, y)$$

bo'lsa, ushbu

$$f(x) = \rho(x, E)$$

funksiyaning R^m da uzluksiz bo'lishi isbotlansin.

2. Ushbu

$$f(x, y) = \begin{cases} \frac{2x^2y}{x^4+y^2}, & \text{agar } x^2 + y^2 > 0 \text{ bo'lsa,} \\ 0, & \text{agar } x = y = 0 \text{ bo'lsa} \end{cases}$$

funksiya uzluksizlikka tekshirilsin.

13- B O B
KO'P O'ZGARUVCHILI FUNKSIYANING HOSILA
VA DIFFERENSIALLARI

59- ma'ruza

Ko'p o'zgaruvchili funksiyaning xususiy hosilalari.
Funksiyaning differensiallanuvchanligi

1°. **Funksiyaning xususiy hosilalari tushunchasi.** Faraz qilaylik, $f(x) = f(x_1, x_2, \dots, x_m)$ funksiya $E \subset R^m$ to'plamda berilgan bo'lib,

$$x^0 = (x_1^0, x_2^0, \dots, x_m^0) \in E, \quad (x_1^0 + \Delta x_1, x_2^0, \dots, x_m^0) \in E, \quad (\Delta x_1 \geq 0)$$

bo'lsin. Bu funksiyaning x^0 nuqtadagi x_1 o'zgaruvchi bo'yicha xususiy orttirmasi

$$\Delta_{x_1} f(x^0) = f(x_1^0 + \Delta x_1, x_2^0, \dots, x_m^0) - f(x_1^0, x_2^0, \dots, x_m^0)$$

Δ_{x_1} ga bog'liq bo'ladi.

1- ta'rif. Ushbu
$$\lim_{\Delta x_1 \rightarrow 0} \frac{\Delta_{x_1} f(x^0)}{\Delta x_1}$$

limit mavjud bo'lsa, bu limit $f(x) = f(x_1, x_2, \dots, x_m)$ funksiyaning $x^0 = (x_1^0, x_2^0, \dots, x_m^0)$ nuqtadagi x_1 o'zgaruvchisi bo'yicha xususiy hosilasi deyiladi. Uni

$$\frac{\partial f(x^0)}{\partial x_1} \quad \text{yoki} \quad f'_{x_1}(x^0)$$

kabi belgilanadi:

$$\frac{\partial f(x^0)}{\partial x_1} = f_{x_1} = \lim_{\Delta x_1 \rightarrow 0} \frac{\Delta_{x_1} f(x^0)}{\Delta x_1} = \lim_{\Delta x_1 \rightarrow 0} \frac{f(x_1^0 + \Delta x_1, x_2^0, \dots, x_m^0) - f(x_1^0, x_2^0, \dots, x_m^0)}{\Delta x_1}$$

Berilgan funksiyaning bu xususiy hosilasini quyidagicha

$$f_{x_1}(x^0) = \lim_{x_1 \rightarrow x_1^0} \frac{f(x_1, x_2^0, \dots, x_m^0) - f(x_1^0, x_2^0, \dots, x_m^0)}{x_1 - x_1^0}$$

deb ta'riflasha ham bo'ladi.

$f(x_1, x_2, \dots, x_m)$ funksiyaning boshqa x_2, x_3, \dots, x_m o'zgaruvchilari bo'yicha xususiy hosilalari ham xuddi shunga o'xshash ta'riflanadi:

$$\frac{\partial f(x^0)}{\partial x_2} = \lim_{\Delta x_2 \rightarrow 0} \frac{\Delta x_2 f(x^0)}{\Delta x_2} = \lim_{\Delta x_2 \rightarrow 0} \frac{f(x_1^0, x_2^0 + \Delta x_2, x_3^0, \dots, x_m^0) - f(x_1^0, x_2^0, \dots, x_m^0)}{\Delta x_2},$$

$$\dots$$

$$\frac{\partial f(x^0)}{\partial x_m} = \lim_{\Delta x_m \rightarrow 0} \frac{\Delta x_m f(x^0)}{\Delta x_m} = \lim_{\Delta x_m \rightarrow 0} \frac{f(x_1^0, x_2^0, \dots, x_{m-1}^0, x_m^0 + \Delta x_m) - f(x_1^0, x_2^0, \dots, x_m^0)}{\Delta x_m},$$

$(\Delta x_k > 0, k = 2, 3, \dots, m).$

Yuqorida keltirilgan ta'riflardan ko'p o'zgaruvchili funksiyaning xususiy hosilalari bir o'zgaruvchili funksiyaning hosilasi kabi ekanligi ko'rinadi. Demak, ko'p o'zgaruvchili funksiyaning xususiy hosilalarini topishda ma'lum jadval va qoidalardan foydalanish mumkin. Jumladan, agar

$$f(x) = f(x_1, x_2, \dots, x_m), \quad g(x) = g(x_1, x_2, \dots, x_m)$$

funksiyalar $E \subset R^m$ to'plamda berilgan bo'lib, $x \in E$ nuqtada xususiy hosilalarga ega bo'lsa, u holda:

$$1) \forall c \in R: \frac{\partial (cf(x))}{\partial x_k} = c \frac{\partial f(x)}{\partial x_k};$$

$$2) \frac{\partial (f(x) + g(x))}{\partial x_k} = \frac{\partial f(x)}{\partial x_k} + \frac{\partial g(x)}{\partial x_k};$$

$$3) \frac{\partial (f(x) \cdot g(x))}{\partial x_k} = \frac{\partial f(x)}{\partial x_k} g(x) + f(x) \frac{\partial g(x)}{\partial x_k};$$

$$4) \frac{\partial \left(\frac{f(x)}{g(x)} \right)}{\partial x_k} = g^{-2}(x) \left(\frac{\partial f(x)}{\partial x_k} g(x) - f(x) \frac{\partial g(x)}{\partial x_k} \right),$$

$$(g(x) \neq 0), \quad k = 1, 2, \dots, m$$

bo'ladi.

2°. Ko'p o'zgaruvchili funksiyaning differensiallanuvchanligi.

Zaruriy shart. Aytaylik, $f(x) = f(x_1, x_2, \dots, x_m)$ funksiya $E \subset R^m$ to'plamda berilgan bo'lib,

$x^0 = (x_1^0, x_2^0, \dots, x_m^0) \in E$, $(x_1^0 + \Delta x_1, x_2^0 + \Delta x_2, \dots, x_m^0 + \Delta x_m) \in E$
 bo'lsin. Ma'lumki, berilgan funksiyaning x^0 nuqtadagi to'la orttirmasi
 $\Delta f(x^0) = f(x^0 + \Delta x_1, x_2^0 + \Delta x_2, \dots, x_m^0 + \Delta x_m) - f(x_1^0, x_2^0, \dots, x_m^0)$
 bo'lib, u $\Delta x_1, \Delta x_2, \dots, \Delta x_m$ larga bog'liq bo'ladi.

2- ta'rif. Agar $\Delta x_1, \Delta x_2, \dots, \Delta x_m$ orttirmalarga bog'liq bo'lmagan shunday A_1, A_2, \dots, A_m sonlar topilib, funksiyaning x^0 nuqtadagi to'liq orttirmasi ushbu

$$\Delta f(x^0) = A_1 \Delta x_1 + A_2 \Delta x_2 + \dots + A_m \Delta x_m + \alpha_1 \Delta x_1 + \alpha_2 \Delta x_2 + \dots + \alpha_m \Delta x_m \quad (1)$$

ko'rinishda ifodalansa, $f(x)$ funksiya x^0 nuqtada differentsiallanuvchi deyiladi, bunda $\alpha_1, \alpha_2, \dots, \alpha_m$ lar $\Delta x_1, \Delta x_2, \dots, \Delta x_m$ larga bog'liq va $\Delta x_1 \rightarrow 0, \Delta x_2 \rightarrow 0, \dots, \Delta x_m \rightarrow 0$ da cheksiz kichik miqdorlar.

Agar $(x_1^0, x_2^0, \dots, x_m^0)$ hamda $(x_1^0 + \Delta x_1, x_2^0 + \Delta x_2, \dots, x_m^0 + \Delta x_m)$ nuqtalar orasidagi masofa

$$\rho = \sqrt{\Delta x_1^2 + \Delta x_2^2 + \dots + \Delta x_m^2}$$

uchun $\Delta x_1 \rightarrow 0, \Delta x_2 \rightarrow 0, \dots, \Delta x_m \rightarrow 0$ da

$$\alpha_1 \Delta x_1 + \alpha_2 \Delta x_2 + \dots + \alpha_m \Delta x_m = 0(\rho)$$

bo'lishini e'tiborga olsak, (1) munosabat ushbu

$$\Delta f(x^0) = A_1 \Delta x_1 + A_2 \Delta x_2 + \dots + A_m \Delta x_m + 0(\rho) \quad (2)$$

ko'rinishga keladi.

Odatda, (1) va (2) munosabatlar $f(x)$ funksiyaning x^0 nuqtada differentsiallanuvchanlik sharti deyiladi.

1- misol. Ushbu

$$f(x) = f(x_1, x_2, \dots, x_m) = x_1^2 + x_2^2 + \dots + x_m^2$$

funksiyaning $\forall (x_1^0, x_2^0, \dots, x_m^0) \in R^m$ nuqtada differentsiallanuvchi bo'lishi ko'rsatilsin.

◀ Berilgan funksiyaning $x^0 = (x_1^0, x_2^0, \dots, x_m^0)$ nuqtadagi to'liq orttirmasini topamiz:

$$\begin{aligned} \Delta f(x^0) &= (x_1^0 + \Delta x_1)^2 + (x_2^0 + \Delta x_2)^2 + \dots + (x_m^0 + \Delta x_m)^2 - \\ &\quad - (x_1^{0^2} + x_2^{0^2} + \dots + x_m^{0^2}) = 2x_1^0 \Delta x_1 + 2x_2^0 \Delta x_2 + \dots + \\ &\quad + 2x_m^0 \Delta x_m + \Delta x_1^2 + \Delta x_2^2 + \dots + \Delta x_m^2. \end{aligned}$$

Agar

$$\begin{aligned} A_1 &= 2x_1^0, \quad A_2 = 2x_2^0, \quad \dots, \quad A_m = 2x_m^0, \\ \alpha_1 &= \Delta x_1, \quad \alpha_2 = \Delta x_2, \quad \dots, \quad \alpha_m = \Delta x_m \end{aligned}$$

deyilsa, u holda

$\Delta f(x^0) = A_1 \Delta x_1 + A_2 \Delta x_2 + \dots + A_m \Delta x_m + \alpha_1 \Delta x_1 + \alpha_2 \Delta x_2 + \dots + \alpha_m \Delta x_m$ bo'ladi. Demak, berilgan funksiya $\forall x^0 \in R^m$ nuqtada differensiallanuvchi. ►

Agar $f(x)$ funksiya $E \subset R^m$ to'plamning har bir nuqtasida differensiallanuvchi bo'lsa, funksiya E to'plamda differensiallanuvchi deyiladi.

1- teorema. Agar $f(x)$ funksiya $x^0 \in E \subset R^m$ nuqtada differensiallanuvchi bo'lsa, u holda funksiya shu nuqtada uzluksiz bo'ladi.

◀ Shartga ko'ra $f(x)$ funksiya x^0 nuqtada differensiallanuvchi. Demak, funksiyaning shu nuqtadagi to'liq orttirmasi

$\Delta f(x^0) = A_1 \Delta x_1 + A_2 \Delta x_2 + \dots + A_m \Delta x_m + \alpha_1 \Delta x_1 + \alpha_2 \Delta x_2 + \dots + \alpha_m \Delta x_m$ bo'ladi. Bu tenglikdan

$$\lim_{\substack{\Delta x_1 \rightarrow 0 \\ \Delta x_2 \rightarrow 0 \\ \dots \\ \Delta x_m \rightarrow 0}} \Delta f(x^0) = 0$$

bo'lishini topamiz. Demak, $f(x)$ funksiya x^0 nuqtada uzluksiz. ►

2- teorema. Agar $f(x)$ funksiya x^0 nuqtada differensiallanuvchi bo'lsa, u holda funksiya shu nuqtada barcha xususiy hosilalarga ega va

$$f'_{x_1}(x^0) = A_1, \quad f'_{x_2}(x^0) = A_2, \quad \dots, \quad f'_{x_m}(x^0) = A_m$$

bo'ladi.

◀ Shartga ko'ra $f(x)$ funksiya x^0 nuqtada differensiallanuvchi. Binobarin, (1) shart bajariladi. U holda

$$\Delta x_1 \neq 0, \quad \Delta x_2 = \Delta x_3 = \dots = \Delta x_m = 0$$

deb olinsa, quyidagi

$$\Delta_{x_1} f(x^0) = A_1 \Delta x_1 + \alpha_1 \Delta x_1$$

tenglik hosil bo'ladi. Bu tenglikdan topamiz:

$$\lim_{\Delta x_1 \rightarrow 0} \frac{\Delta_{x_1} f(x^0)}{\Delta x_1} = \lim_{\Delta x_1 \rightarrow 0} (A_1 + \alpha_1) = A_1.$$

Demak,

$$f'_{x_1}(x^0) = A_1.$$

Xuddi shunga o'xshash $f(x)$ funksiyaning x^0 nuqtada $f'_{x_2}(x^0)$, $f'_{x_3}(x^0)$, ..., $f'_{x_m}(x^0)$ xususiy hosilalarining mavjudligi hamda

$$f'_{x_2}(x^0) = A_2, \quad f'_{x_3}(x^0) = A_3, \quad \dots, \quad f'_{x_m}(x^0) = A_m$$

bo'lishi ko'rsatiladi. ►

Bu teoremadan x^0 nuqtada differensiallanuvchi $f(x)$ funksiyaning orttirmasi uchun

$$\Delta f(x^0) = f'_{x_1}(x^0) \Delta x_1 + f'_{x_2}(x^0) \Delta x_2 + \dots + f'_{x_m}(x^0) \Delta x_m + o(\rho)$$

bo'lishi kelib chiqadi.

Eslatma. $f(x)$ funksiyaning biror x^0 nuqtada barcha xususiy hosilalari

$$f'_{x_1}(x^0), f'_{x_2}(x^0), f'_{x_3}(x^0), \dots, f'_{x_m}(x^0)$$

ning mavjud bo'lishidan, uning shu nuqtada differensiallanuvchi bo'lishi har doim kelib chiqavermaydi (bunga misol keyingi bandda keltiriladi).

Yuqorida keltirilgan teorema va eslatmadan $f(x)$ funksiyaning x^0 nuqtada barcha xususiy hosilalarga ega bo'lishi funksiyaning shu nuqtada differensiallanuvchi bo'lishining zaruriy sharti ekanligi kelib chiqadi.

3°. Funksiya differensiallanuvchanligining yetarli sharti. Faraz qilaylik, $f(x)$ funksiya $E \subset R^m$ to'plamda berilgan bo'lib, $U_\delta(x^0) \subset E$ bo'lsin ($\delta > 0$).

3- teorema. Agar $f(x)$ funksiya $U_\delta(x^0)$ da barcha xususiy hosilalarga ega bo'lib, bu xususiy hosilalar x^0 nuqtada uzluksiz bo'lsa, $f(x)$ funksiya x^0 nuqtada differensiallanuvchi bo'ladi.

◀ Ushbu

$$(x_1^0 + \Delta x_1, x_2^0 + \Delta x_2, \dots, x_m^0 + \Delta x_m) \in U_\delta(x^0)$$

$$\begin{aligned}
\Delta f &= \frac{\partial f}{\partial x_1} \left[\frac{\partial x_1}{\partial t_1} \Delta t_1 + \frac{\partial x_1}{\partial t_2} \Delta t_2 + \dots + \frac{\partial x_1}{\partial t_k} \Delta t_k + 0(\rho) \right] + \\
&+ \frac{\partial f}{\partial x_2} \left[\frac{\partial x_2}{\partial t_1} \Delta t_1 + \frac{\partial x_2}{\partial t_2} \Delta t_2 + \dots + \frac{\partial x_2}{\partial t_k} \Delta t_k + 0(\rho) \right] + \dots + \\
&+ \frac{\partial f}{\partial x_m} \left[\frac{\partial x_m}{\partial t_1} \Delta t_1 + \frac{\partial x_m}{\partial t_2} \Delta t_2 + \dots + \frac{\partial x_m}{\partial t_k} \Delta t_k + 0(\rho) \right] + \\
&+ \alpha_1 \Delta x_1 + \alpha_2 \Delta x_2 + \dots + \alpha_m \Delta x_m = \left(\frac{\partial f}{\partial x_1} \cdot \frac{\partial x_1}{\partial t_1} + \frac{\partial f}{\partial x_2} \cdot \frac{\partial x_2}{\partial t_1} + \dots + \right. \\
&+ \left. \frac{\partial f}{\partial x_m} \cdot \frac{\partial x_m}{\partial t_1} \right) \Delta t_1 + \left(\frac{\partial f}{\partial x_1} \cdot \frac{\partial x_1}{\partial t_2} + \frac{\partial f}{\partial x_2} \cdot \frac{\partial x_2}{\partial t_2} + \dots + \frac{\partial f}{\partial x_m} \cdot \frac{\partial x_m}{\partial t_2} \right) \Delta t_2 + \dots + \\
&+ \left(\frac{\partial f}{\partial x_1} \cdot \frac{\partial x_1}{\partial t_k} + \frac{\partial f}{\partial x_2} \cdot \frac{\partial x_2}{\partial t_k} + \dots + \frac{\partial f}{\partial x_m} \cdot \frac{\partial x_m}{\partial t_k} \right) \Delta t_k + \\
&+ \left(\frac{\partial f}{\partial x_1} + \frac{\partial f}{\partial x_2} + \dots + \frac{\partial f}{\partial x_m} \right) \cdot 0(\rho) + \alpha_1 \Delta x_1 + \alpha_2 \Delta x_2 + \dots + \alpha_m \Delta x_m.
\end{aligned}$$

Bu tenglikdan $\left(\frac{\partial f}{\partial x_1} + \frac{\partial f}{\partial x_2} + \dots + \frac{\partial f}{\partial x_m} \right) \cdot 0(\rho) = 0(\rho)$.

$\Delta t_1 \rightarrow 0, \Delta t_2 \rightarrow 0, \dots, \Delta t_k \rightarrow 0$, ya'ni $\rho \rightarrow 0$ da

$\Delta x_1 \rightarrow 0, \Delta x_2 \rightarrow 0, \dots, \Delta x_m \rightarrow 0$ va $\alpha_1 \rightarrow 0, \alpha_2 \rightarrow 0, \dots, \alpha_m \rightarrow 0$ bo'lgani sababli

$$\alpha_1 \Delta x_1 + \alpha_2 \Delta x_2 + \dots + \alpha_m \Delta x_m = 0(\rho)$$

bo'lishi hamda quyidagi

$$A_j = \frac{\partial f}{\partial x_1} \cdot \frac{\partial x_1}{\partial t_j} + \frac{\partial f}{\partial x_2} \cdot \frac{\partial x_2}{\partial t_j} + \dots + \frac{\partial f}{\partial x_m} \cdot \frac{\partial x_m}{\partial t_j} \quad (8)$$

($j = 1, 2, \dots, k$) belgilashlar natijasida

$$\Delta f = A_1 \Delta t_1 + A_2 \Delta t_2 + \dots + A_m \Delta t_m + 0(\rho) \quad (9)$$

bo'ladi. Demak, murakkab funksiya t^0 nuqtada differensiallanuvchi. ►

Aytilik, $f(x(t))$ murakkab funksiya yuqoridagi teoremaning shartlarini qanoatlantirsin. U holda

$$\Delta f(t) = \frac{\partial f}{\partial t_1} \Delta t_1 + \frac{\partial f}{\partial t_2} \Delta t_2 + \dots + \frac{\partial f}{\partial t_k} \Delta t_k + 0(\rho)$$

bo'lad. Bu hamda (8), (9) munosabatlardan foydalanib murakkab funksiyaning xususiy hosilalari quyidagicha

$$\begin{aligned} \frac{\partial f}{\partial t_1} &= \frac{\partial f}{\partial x_1} \frac{\partial x_1}{\partial t_1} + \frac{\partial f}{\partial x_2} \frac{\partial x_2}{\partial t_1} + \dots + \frac{\partial f}{\partial x_m} \frac{\partial x_m}{\partial t_1}, \\ \frac{\partial f}{\partial t_2} &= \frac{\partial f}{\partial x_1} \frac{\partial x_1}{\partial t_2} + \frac{\partial f}{\partial x_2} \frac{\partial x_2}{\partial t_2} + \dots + \frac{\partial f}{\partial x_m} \frac{\partial x_m}{\partial t_2}, \\ &\dots\dots\dots \\ \frac{\partial f}{\partial t_k} &= \frac{\partial f}{\partial x_1} \frac{\partial x_1}{\partial t_k} + \frac{\partial f}{\partial x_2} \frac{\partial x_2}{\partial t_k} + \dots + \frac{\partial f}{\partial x_m} \frac{\partial x_m}{\partial t_k} \end{aligned}$$

bo'lishini topamiz.

5°. Xususiy hollar. $m = 1$ bo'lganda bir o'zgaruvchili $u = f(x)$ ($x \in R, u \in R$) funksiya hosilasi tushunchasiga kelamiz. Bular haqidagi ma'lumotlar 19–21- ma'ruzalarda bayon etilgan.

$m = 2$ bo'lsin. Bu holda ikki o'zgaruvchili $u = f(x, y)$ ($(x, y) \in E \subset R^2, u \in R$) funksiyaning xususiy hosilalari

$$\begin{aligned} \frac{\partial f}{\partial x} &= \lim_{\Delta x \rightarrow 0} \frac{\Delta_x f}{\Delta x} = \lim_{\Delta x \rightarrow 0} \frac{f(x + \Delta x, y) - f(x, y)}{\Delta x}, \\ \frac{\partial f}{\partial y} &= \lim_{\Delta y \rightarrow 0} \frac{\Delta_y f}{\Delta y} = \lim_{\Delta y \rightarrow 0} \frac{f(x, y + \Delta y) - f(x, y)}{\Delta y} \end{aligned}$$

hamda quyidagi

$$\Delta f = f(x + \Delta x, y + \Delta y) - f(x, y) = A\Delta x + B\Delta y + \alpha_1\Delta x + \alpha_2\Delta y$$

differensiallanuvchanlik shartiga ega bo'lamiz.

2- misol. Ushbu $f(x, y) = \ln \operatorname{tg} \frac{x}{y}$

funksiyaning xususiy hosilalari topilsin.

◀ Berilgan funksiyaning xususiy hosilalari quyidagicha bo'ladi:

$$\frac{\partial f}{\partial x} = \frac{\partial}{\partial x} \left(\ln \operatorname{tg} \frac{x}{y} \right) = \frac{1}{\operatorname{tg} \frac{x}{y}} \cdot \frac{1}{\cos^2 \frac{x}{y}} \cdot \frac{1}{y} = \frac{2}{y \sin \frac{2x}{y}};$$

$$\frac{\partial f}{\partial y} = \frac{\partial}{\partial y} \left(\ln \operatorname{tg} \frac{x}{y} \right) = \frac{1}{\operatorname{tg} \frac{x}{y}} \cdot \frac{1}{\cos^2 \frac{x}{y}} \cdot \left(-\frac{x}{y^2} \right) = \frac{-2}{y^2 \sin \frac{2x}{y}}. \blacktriangleright$$

3- misol. Ushbu

$$f(x, y) = \begin{cases} \frac{2xy}{x^2+y^2}, & \text{agar } (x, y) \neq (0, 0) \text{ bo'lsa,} \\ 0, & \text{agar } (x, y) = (0, 0) \text{ bo'lsa} \end{cases}$$

funksiyaning xususiy hosilalari topilsin.

◀ Aytaylik, $(x, y) \neq (0, 0)$ bo'lsin. U holda

$$\frac{\partial f}{\partial x} = \frac{\partial}{\partial x} \left(\frac{2xy}{x^2+y^2} \right) = \frac{2y(x^2+y^2) - 2xy \cdot 2x}{(x^2+y^2)^2} = \frac{2y(y^2-x^2)}{(x^2+y^2)^2},$$

$$\frac{\partial f}{\partial y} = \frac{\partial}{\partial y} \left(\frac{2xy}{x^2+y^2} \right) = \frac{2x(x^2+y^2) - 2xy \cdot 2y}{(x^2+y^2)^2} = \frac{2x(x^2-y^2)}{(x^2+y^2)^2}$$

bo'ladi.

Aytaylik, $(x, y) = (0, 0)$ bo'lsin. Bu holda ta'rifdan foydalanib topamiz:

$$\frac{\partial f(0,0)}{\partial x} = \lim_{\Delta x \rightarrow 0} \frac{f(0+\Delta x, 0) - f(0,0)}{\Delta x} = \lim_{\Delta x \rightarrow 0} \frac{2\Delta x \cdot 0}{\Delta x^3} = 0,$$

$$\frac{\partial f(0,0)}{\partial y} = \lim_{\Delta y \rightarrow 0} \frac{f(0, 0+\Delta y) - f(0,0)}{\Delta y} = \lim_{\Delta y \rightarrow 0} \frac{2\Delta y \cdot 0}{\Delta y^3} = 0. \blacktriangleright$$

4- misol. Ushbu $f(x, y) = \sqrt{x^2 + y^2}$ funksiyaning xususiy hosilalari topilsin.

◀ Aytaylik, $(x, y) \neq (0, 0)$ bo'lsin. Bu holda

$$\frac{\partial f}{\partial x} = \frac{\partial}{\partial x} \sqrt{x^2 + y^2} = \frac{2x}{2\sqrt{x^2+y^2}} = \frac{x}{\sqrt{x^2+y^2}},$$

$$\frac{\partial f}{\partial y} = \frac{\partial}{\partial y} \sqrt{x^2 + y^2} = \frac{2y}{2\sqrt{x^2+y^2}} = \frac{y}{\sqrt{x^2+y^2}}$$

bo'ladi.

Aytaylik, $(x, y) = (0, 0)$ bo'lsin. Ta'rifga ko'ra

$$\frac{\partial f(0,0)}{\partial x} = \lim_{\Delta x \rightarrow 0} \frac{f(0+\Delta x, 0) - f(0,0)}{\Delta x} = \lim_{\Delta x \rightarrow 0} \frac{|\Delta x|}{\Delta x},$$

$$\frac{\partial f(0,0)}{\partial y} = \lim_{\Delta y \rightarrow 0} \frac{f(0, 0+\Delta y) - f(0,0)}{\Delta y} = \lim_{\Delta y \rightarrow 0} \frac{|\Delta y|}{\Delta y}$$

bo'lib, bu limitlar mavjud bo'lmaganligi sababli berilgan funksiya $(0,0)$ nuqtada xususiy hosilalarga ega bo'lmaydi. ▶

5- misol. Ushbu

$$f(x, y) = \begin{cases} \frac{x^3 y}{x^6 + y^2}, & \text{agar } (x, y) \neq (0, 0) \text{ bo'lsa,} \\ 0, & \text{agar } (x, y) = (0, 0) \text{ bo'lsa} \end{cases}$$

funksiyaning $(0, 0)$ nuqtadagi xususiy hosilalari topilsin.

◀ Ta'rifga ko'ra

$$\frac{\partial f(0,0)}{\partial x} = \lim_{\Delta x \rightarrow 0} \frac{f(0+\Delta x, 0) - f(0,0)}{\Delta x} = 0,$$

$$\frac{\partial f(0,0)}{\partial y} = \lim_{\Delta y \rightarrow 0} \frac{f(0, 0+\Delta y) - f(0,0)}{\Delta y} = 0$$

bo'ladi. Biroq berilgan funksiya $(0, 0)$ nuqtada uzluksiz bo'lmaydi, chunki

$$\left(\frac{1}{n}, \frac{1}{n^3}\right) \rightarrow (0, 0) \text{ da } f\left(\frac{1}{n}, \frac{1}{n^3}\right) = \frac{1}{2} \rightarrow \frac{1}{2} \neq f(0, 0). \blacktriangleright$$

6- misol. Ushbu

$$f(x, y) = \begin{cases} \frac{xy}{\sqrt{x^2 + y^2}}, & \text{agar } (x, y) \neq (0, 0) \text{ bo'lsa,} \\ 0, & \text{agar } (x, y) = (0, 0) \text{ bo'lsa} \end{cases}$$

funksiyaning $(0, 0)$ nuqtada xususiy hosilalarining mavjudligi, ammo shu nuqtada differensiallanuvchi emasligi ko'rsatilsin.

◀ Ravshanki,

$$\frac{\partial f(0,0)}{\partial x} = \lim_{\Delta x \rightarrow 0} \frac{f(\Delta x, 0) - f(0,0)}{\Delta x} = 0,$$

$$\frac{\partial f(0,0)}{\partial y} = \lim_{\Delta y \rightarrow 0} \frac{f(0, \Delta y) - f(0,0)}{\Delta y} = 0.$$

Demak, berilgan funksiyaning $(0, 0)$ nuqtada xususiy hosilalari mavjud va ular 0 ga teng.

Bu funksiya $(0, 0)$ nuqtada differensiallanuvchi bo'lmaydi. Shuni isbotlaymiz. Teskarisini faraz qilaylik, qaralayotgan funksiya $(0,0)$ nuqtada differensiallanuvchi bo'lsin:

$$\begin{aligned}\Delta f(0,0) &= \frac{\partial f(0,0)}{\partial x} \Delta x + \frac{\partial f(0,0)}{\partial y} \Delta y + \alpha_1 \Delta x + \alpha_2 \Delta y = \\ &= \alpha_1 \Delta x + \alpha_2 \Delta y, \quad (\Delta x \rightarrow 0, \Delta y \rightarrow 0 \text{ da } \alpha_1 \rightarrow 0, \alpha_2 \rightarrow 0).\end{aligned}$$

Ayni paytda,

$$\Delta f(0,0) = f(0 + \Delta x, 0 + \Delta y) - f(0,0) = f(\Delta x, \Delta y) = \frac{\Delta x \Delta y}{\sqrt{\Delta x^2 + \Delta y^2}}$$

bo'ladi. Demak, $\frac{\Delta x \Delta y}{\sqrt{\Delta x^2 + \Delta y^2}} = \alpha_1 \Delta x + \alpha_2 \Delta y$.

Bu tenglikdan, $\Delta x = \Delta y > 0$ bo'lganda

$$\alpha_1 + \alpha_2 = \frac{1}{\sqrt{2}}$$

bo'lishi kelib chiqadi. Bu esa $\Delta x = \Delta y > 0$ da $\alpha_1 \rightarrow 0, \alpha_2 \rightarrow 0$ bo'lishiga zid. Demak, berilgan funksiya $(0,0)$ nuqtada differensiallanuvchi emas. ►

7- misol. Agar $f(x,y)$ funksiya R^2 da differensiallanuvchi bo'lib.

$x = r \cos \varphi, y = r \sin \varphi$ bo'lsa, $\frac{\partial f}{\partial r}, \frac{\partial f}{\partial \varphi}$ lar topilsin.

◀ Ravshanki,

$$f(x, y) = f(r \cos \varphi, r \sin \varphi).$$

Murakkab funksiyaning xususiy hosilalarini topish qoidasiga ko'ra

$$\frac{\partial f}{\partial r} = \frac{\partial f}{\partial x} \cdot \frac{\partial x}{\partial r} + \frac{\partial f}{\partial y} \cdot \frac{\partial y}{\partial r} = \cos \varphi \frac{\partial f}{\partial x} + \sin \varphi \frac{\partial f}{\partial y} = \frac{1}{\sqrt{x^2 + y^2}} \left(x \frac{\partial f}{\partial x} + y \frac{\partial f}{\partial y} \right),$$

$$\frac{\partial f}{\partial \varphi} = \frac{\partial f}{\partial x} \cdot \frac{\partial x}{\partial \varphi} + \frac{\partial f}{\partial y} \cdot \frac{\partial y}{\partial \varphi} = -r \sin \varphi \frac{\partial f}{\partial x} + r \cos \varphi \frac{\partial f}{\partial y} = -y \frac{\partial f}{\partial x} + x \frac{\partial f}{\partial y}. \quad \blacktriangleright$$

Mashqlar

1. Ushbu

$$f(x, y) = \left(\frac{y}{x}\right)^x, \quad f(x, y) = \ln \sin \frac{x+1}{\sqrt{y}}$$

funksiya(lar)ning xususiy hosilalari topilsin.

2. Agar

$$f(x, y) = x \sin y + y \sin x, \quad x = \frac{u}{v}, \quad y = u \cdot v$$

bo'lsa, $\frac{\partial f}{\partial u}, \frac{\partial f}{\partial v}$ lar topilsin.

3. Aytaylik, $f(x)$ va $g(x)$ funksiyalar $U_\delta(x^0) \subset R^m$ da aniqlangan bo'lib,

1) $f(x)$ funksiya x^0 nuqtada differensiyallanuvchi va $f(x_0) = 0$,

2) $g(x)$ funksiya x^0 nuqtada uzluksiz bo'lsa, $f(x) \cdot g(x)$ funksiyaning x^0 nuqtada differensiallanuvchi bo'lishi ko'rsatilsin.

4. Ushbu $f(x, y) = \sqrt{|xy|}$

funksiyaning $(0,0)$ nuqtada differensiallanuvchi emasligi isbotlansin.

60- ma'ruza

O'rta qiymat haqida teorema. Yo'nalish bo'yicha hosila

1°. **O'rta qiymat haqida teorema.** Faraz qilaylik, $f(x) = f(x_1, x_2, \dots, x_m)$ funksiya $E \subset R^m$ to'plamda berilgan bo'lsin. Bu E to'plamda shunday

$$a = (a_1, a_2, \dots, a_m), \quad b = (b_1, b_2, \dots, b_m)$$

nuqtalarni qaraymizki, bu nuqtalarni birlashtiruvchi to'g'ri chiziq kesmasi E to'plamga tegishli bo'lsin.

Ravshanki, bu kesma ushbu

$$K = \{(x_1, x_2, \dots, x_m) \in R^m : x_1 = a_1 + t(b_1 - a_1), \\ x_2 = a_2 + t(b_2 - a_2), \dots, x_m = a_m + t(b_m - a_m), \quad (0 \leq t \leq 1)\}$$

nuqtalar to'plami bilan ifodalanadi: $K \subset E$.

1- teorema. Agar $f(x)$ funksiya K kesmaning a va b nuqtalarida uzluksiz bo'lib, kesmaning qolgan barcha nuqtalarida differensiallanuvchi bo'lsa, u holda K kesmada shunday $c = (c_1, c_2, \dots, c_m)$ nuqta topiladiki, bunda

$$f(b) - f(a) = f'_{x_1}(c)(b_1 - a_1) + f'_{x_2}(c)(b_2 - a_2) + \dots + f'_{x_m}(c)(b_m - a_m) \quad (1)$$

bo'ladi.

◀ $f(x)$ funksiya $K \subset E$ kesmada quyidagi

$$f(x) = f(x_1, x_2, \dots, x_m) = f(a_1 + t(b_1 - a_1), a_2 + t(b_2 - a_2), \dots, a_m + t(b_m - a_m)), \quad (0 \leq t \leq 1)$$

ko'rinishda bo'ladi. Bu t o'zgaruvchining funksiyasini $F(t)$ bilan belgilaylik:

$$F(t) = f(a_1 + t(b_1 - a_1), a_2 + t(b_2 - a_2), \dots, a_m + t(b_m - a_m)).$$

Ravshanki, $F(t)$ funksiya $[0, 1]$ segmentda uzluksiz bo'lib, $(0, 1)$ da

$$F'(t) = f'_{x_1}(b_1 - a_1) + f'_{x_2}(b_2 - a_2) + \dots + f'_{x_m}(b_m - a_m)$$

hosilaga ega bo'ladi. Bunda $f'_{x_1}, f'_{x_2}, \dots, f'_{x_m}$ xususiy hosilalarning

$$(a_1 + t(b_1 - a_1), a_2 + t(b_2 - a_2), \dots, a_m + t(b_m - a_m))$$

nuqtadagi qiymatlari olingan.

Lagranj teoremasidan foydalanib topamiz:

$$F(1) - F(0) = F'(t_0), \quad (0 < t_0 < 1). \quad (2)$$

Agar

$$F(0) = f(a), \quad F(1) = f(b) \quad (3)$$

hamda

$$F'(t_0) = f'_{x_1}(a_1 + t_0(b_1 - a_1), a_2 + t_0(b_2 - a_2), \dots, a_m + t_0(b_m - a_m)) \times \\ \times (b_1 - a_1) + f'_{x_2}(a_1 + t_0(b_1 - a_1), a_2 + t_0(b_2 - a_2), \dots, a_m + t_0(b_m - a_m)) \times \\ \times (b_2 - a_2) + \dots + f'_{x_m}(a_1 + t_0(b_1 - a_1), \dots, a_m + t_0(b_m - a_m)) \cdot (b_m - a_m) \quad (4)$$

bo'lishini e'tiborga olsak, so'ngra ushbu

$$\begin{aligned} a_1 + t_0(b_1 - a_1) &= c_1, \\ a_2 + t_0(b_2 - a_2) &= c_2, \\ &\dots \dots \dots \\ a_m + t_0(b_m - a_m) &= c_m \end{aligned}$$

belgilashlarni bajarsak, u holda

$$c = (c_1, c_2, \dots, c_m) \in K$$

bo'lib, (2), (3) va (4) munosabatlardan

$$f(b) - f(a) = f'_{x_1}(c)(b_1 - a_1) + f'_{x_2}(c)(b_2 - a_2) + \dots + f'_{x_m}(c)(b_m - a_m)$$

bo'lishi kelib chiqadi. ►

Odatda, (1) formula *Lagranjning chekli orttirmalar formulasi* deyiladi.

2°. Xususiy hollar. Yo'nalish bo'yicha hosila. $m = 1$ bo'lganda yuqoridagi teoremda keltirilgan formula

$$f(b) - f(a) = f'(c) \cdot (b - a)$$

($a \in R, b \in R, a < c < b$) ko'rinishga keladi. Bu Lagranj teoremasini ifodalovchi formula bo'lib, 21- ma'ruzada o'rganilgan.

$m = 2$ bo'lganda (1) formula

$$f(b) - f(a) = f'_x(c)(b_1 - a_1) + f'_y(c)(b_2 - a_2),$$

$$(b = (b_1, b_2) \in R^2, a = (a_1, a_2) \in R^2, c = (c_1, c_2) \in R^2)$$

ko'rinishda bo'ladi.

Ma'lumki, $u = f(x)$, ($x \in R, u \in R$) funksiyaning hosilasi $f'(x)$ shu funksiyaning o'zgarishini (o'zgarish tezligini) ifodalaydi. $u = f(x)$, ($(x, y) \in R^2, u \in R$) ikki o'zgaruvchili funksiyaning $f'_x(x, y)$, $f'_y(x, y)$ xususiy hosilalari funksiyaning mos ravishda OX hamda OY o'qlar bo'yicha o'zgarish tezligini bildiradi. Boshqacha aytganda, $f(x, y)$ funksiyaning xususiy hosilalari koordinata o'qlari yo'nalishi bo'yicha hosilalar bo'ladi.

Endi $f(x, y)$ funksiyaning tekislikdagi ixtiyoriy tayin yo'nalish bo'yicha hosilasi tushunchasini keltiramiz.

Faraz qilaylik, $f(x, y)$ funksiya $E \subset R^2$ to'plamda berilgan bo'lsin. Bu funksiyaning Dekart koordinatalar sistemasida tasvirlangan $A_0 = (x_0, y_0)$ nuqtaning $U_\delta(A_0) \subset E$, ($\delta > 0$) atrofida qaraymiz. Ushbu $A = (x, y) \in U_\delta(A_0)$ nuqtani olib, A_0 va A nuqtalar orqali to'g'ri chiziq o'tkazamiz. Undagi ikki yo'nalishdan birini musbat yo'nalish (26- chizmada ko'rsatilgandek), ikkinchisini esa manfiy yo'nalish deb qabul qilamiz. Bu yo'nalgan to'g'ri chiziqni l bilan belgilaymiz. A_0 va A nuqtalar orasidagi masofa

$$\rho = \rho(A_0, A) = \sqrt{(x - x_0)^2 + (y - y_0)^2}$$

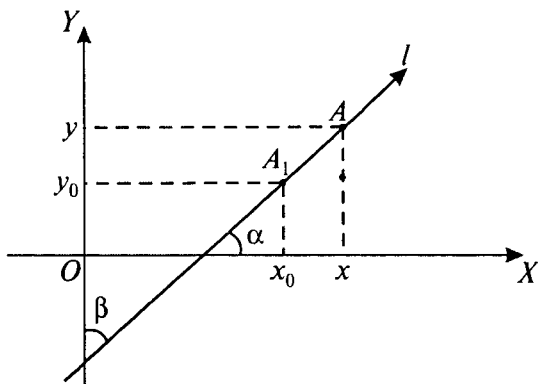

26- chizma.

bo'lib, bu masofa $\overline{A_0A}$ vektorning yo'nalishi l ning yo'nalishi bilan bir xil bo'lsa, musbat ishora bilan, aks holda, manfiy ishora bilan olinadi.

Agar l ning musbat yo'nalishi bilan OX va OY koordinata o'qlarining musbat yo'nalishlari orasidagi burchakni mos ravishda α va β deyilsa (26- chizma), u holda

$$\frac{x-x_0}{\rho} = \cos \alpha, \quad \frac{y-y_0}{\rho} = \cos \beta$$

bo'lishi topiladi.

1- ta'rif. Agar
$$\lim_{A \rightarrow A_0} \frac{f(A) - f(A_0)}{\rho}$$

limit mavjud bo'lsa, bu limit $f(x, y)$ funksiyaning $A_0 = (x_0, y_0)$ nuqtadagi l yo'nalish bo'yicha hosilasi deyiladi. Uni

$$\frac{\partial f(A_0)}{\partial l} \quad \text{yoki} \quad \frac{\partial f(x_0, y_0)}{\partial l}$$

kabi belgilanadi. Demak,
$$\frac{\partial f(A_0)}{\partial l} = \lim_{A \rightarrow A_0} \frac{f(A) - f(A_0)}{\rho}.$$

1- misol. Ushbu $f(x, y) = \sqrt[3]{x^2 y}$

funksiyaning $(0, 0)$ nuqtada barcha yo'nalishlar bo'icha hosilalarining mavjudligi ko'rsatilsin.

◀ Aytaylik, $\alpha \neq \pm \frac{\pi}{2}$ bo'lsin. Bu holda

$$y = \operatorname{tg} \alpha \cdot x$$

bo'lib,

$$f(x, y) = \sqrt[3]{x^3 \operatorname{tg} \alpha} = x \sqrt[3]{\operatorname{tg} \alpha},$$

$$\rho((x, y), (0, 0)) = \sqrt{x^2 + x^2 \operatorname{tg}^2 \alpha} = |x| \sqrt{1 + \operatorname{tg}^2 \alpha}$$

bo'ladi. U holda berilgan funksiyaning $(0, 0)$ nuqtadagi $\alpha \neq \pm \frac{\pi}{2}$ bo'lgan ixtiyoriy yo'nalish bo'yicha hosilasi, ta'rifga binoan,

$$\frac{\partial f(0, 0)}{\partial l} = \lim_{\rho \rightarrow 0} \frac{f(x, y) - f(0, 0)}{\rho} = \lim_{\rho \rightarrow 0} \frac{\sqrt[3]{\operatorname{tg} \alpha} \cdot x}{\sqrt{1 + \operatorname{tg}^2 \alpha} \cdot |x|}$$

bo'ladi.

Agar $-\frac{\pi}{2} < \alpha < \frac{\pi}{2}$ bo'lsa, u holda $x > 0$, $|x| = x$ bo'lib,

$$\frac{\partial f(0, 0)}{\partial l} = \frac{\sqrt[3]{\operatorname{tg} \alpha}}{\sqrt{1 + \operatorname{tg}^2 \alpha}}$$

bo'ladi.

Agar $\frac{\pi}{2} < \alpha < \frac{3\pi}{2}$ bo'lsa, u holda $x < 0$, $|x| = -x$ bo'lib,

$$\frac{\partial f(0, 0)}{\partial l} = -\frac{\sqrt[3]{\operatorname{tg} \alpha}}{\sqrt{1 + \operatorname{tg}^2 \alpha}}$$

bo'ladi.

Aytaylik, $\alpha \neq \pm \frac{\pi}{2}$ bo'lsin. Bu holda $x = 0$, $f(0, y) = 0$ bo'lib, bu yo'nalishlar bo'yicha hosila

$$\frac{\partial f(0, 0)}{\partial l} = 0$$

bo'ladi. ►

1- teorema. Agar $f(x, y)$ funksiya $A_0 = (x_0, y_0)$ nuqtada differensiallanuvchi bo'lsa, u holda funksiya shu nuqtada har qanday yo'nalish bo'yicha hosilaga ega va

$$\frac{\partial f(A_0)}{\partial l} = \frac{\partial f(x_0, y_0)}{\partial l} = \frac{\partial f(x_0, y_0)}{\partial x} \cos \alpha + \frac{\partial f(x_0, y_0)}{\partial y} \cos \beta \quad (5)$$

bo'ladi.

◀ Aytaylik, $f(x,y)$ funksiya $A_0 = (x_0, y_0)$ nuqtada differensiallanuvchi bo'lsin. U holda

$$f(A) - f(A_0) = f(x, y) - f(x_0, y_0)$$

orttirma uchun

$$f(A) - f(A_0) = \frac{\partial f(A_0)}{\partial x} \cdot (x - x_0) + \frac{\partial f(A_0)}{\partial y} \cdot (y - y_0) + 0(\rho)$$

bo'ladi, bunda $\rho = \sqrt{(x - x_0)^2 + (y - y_0)^2}$.

Keyingi tenglikning har ikki tomonini ρ ga bo'lamiz:

$$\frac{f(A) - f(A_0)}{\rho} = \frac{\partial f(A_0)}{\partial x} \cdot \frac{x - x_0}{\rho} + \frac{\partial f(A_0)}{\partial y} \cdot \frac{y - y_0}{\rho} + \frac{0(\rho)}{\rho}.$$

Ma'lumki, $\frac{x - x_0}{\rho} = \cos \alpha$, $\frac{y - y_0}{\rho} = \cos \beta$.

Shuni e'tiborga olib, $\rho \rightarrow 0$ da limitga o'tib topamiz:

$$\lim_{\rho \rightarrow 0} \frac{f(A) - f(A_0)}{\rho} = \frac{\partial f(A_0)}{\partial x} \cos \alpha + \frac{\partial f(A_0)}{\partial y} \cos \beta.$$

Demak, $\frac{\partial f(A_0)}{\partial l} = \frac{\partial f(x_0, y_0)}{\partial x} \cos \alpha + \frac{\partial f(x_0, y_0)}{\partial y} \cos \beta$. ▶

2- misol. Ushbu $f(x, y) = x^2 + y^2$ funksiyaning $(1, 1)$ nuqtada $\vec{r} = \vec{i} + 2\vec{j}$ vektor yo'nalish bo'yicha hosilasi topilsin.

◀ Ravshanki, bu holda

$$\cos \alpha = \frac{1}{\sqrt{5}}, \quad \cos \beta = \frac{2}{\sqrt{5}},$$

$$\frac{\partial f(x, y)}{\partial x} = \frac{\partial(x^2 + y^2)}{\partial x} = 2x, \quad \frac{\partial f(1, 1)}{\partial x} = 2,$$

$$\frac{\partial f(x, y)}{\partial y} = \frac{\partial(x^2 + y^2)}{\partial y} = 2y, \quad \frac{\partial f(1, 1)}{\partial y} = 2$$

bo'ladi. (5) formuladan foydalanib topamiz:

$$\frac{\partial f(1, 1)}{\partial l} = 2 \cdot \frac{1}{\sqrt{5}} + 2 \cdot \frac{2}{\sqrt{5}} = \frac{6}{\sqrt{5}}. \quad \blacktriangleright$$

Faraz qilaylik, $f(x,y)$ funksiya ochiq $E \subset R^m$ to'plamda differensiallanuvchi bo'lsin. Binobarin, funksiya E to'plamning har bir $(x,y) \in E$ nuqtasida

$$\frac{\partial f(x,y)}{\partial x}, \quad \frac{\partial f(x,y)}{\partial y}$$

xususiy hosilalarga ega bo'ladi. Koordinatalari shu xususiy hosilalardan iborat bo'lgan vektorni tuzamiz:

$$\frac{\partial f(x,y)}{\partial x} \cdot \vec{i} + \frac{\partial f(x,y)}{\partial y} \cdot \vec{j}, \quad (6)$$

bunda \vec{i} va \vec{j} – koordinata o'qlari bo'yicha yo'nalgan birlik vektorlar. (6) vektor $f(x,y)$ funksiyaning *gradiyenti* deyiladi va *grad f* kabi belgilanadi:

$$\text{grad } f = \frac{\partial f(x,y)}{\partial x} \cdot \vec{i} + \frac{\partial f(x,y)}{\partial y} \cdot \vec{j}.$$

Demak, *grad f* E to'plamning har bir (x,y) nuqtasiga bitta vektorni mos qo'yuvchi qoida, boshqacha aytganda, ikki o'zgaruvchili vektor funksiya bo'ladi.

$f(x,y)$ funksiyaning $\vec{e} = (\cos \alpha, \cos \beta)$ vektor yo'nalishi bo'yicha $\frac{\partial f(x,y)}{\partial l}$ hosilasini uning gradiyenti orqali ifodalash mumkin. Haqiqatan ham, *grad f* va \vec{e} vektorlarning skalyar ko'paytmasi

$$\vec{e} \cdot \text{grad } f = \cos \alpha \frac{\partial f(x,y)}{\partial x} + \cos \beta \frac{\partial f(x,y)}{\partial y} \quad (7)$$

bo'lib, u (5) formulaga ko'ra $\frac{\partial f(x,y)}{\partial l}$ ga teng bo'ladi:

$$\vec{e} \text{ grad } f = \frac{\partial f(x,y)}{\partial l}.$$

Ayni paytda, \vec{e} va *grad f* vektorlarning skalyar ko'paytmasi shu vektor uzunliklari ko'paytmasining ular orasidagi burchak kosinusiga ko'paytirilganiga teng bo'ladi:

$$\vec{e} \text{ grad } f = |\text{grad } f| \cdot |\vec{e}| \cdot \cos(\hat{\vec{e}}, \text{grad } f). \quad (8)$$

Ravshanki, $|\vec{e}| = 1$. (7) va (8) munosabatlardan

$$\frac{\partial f(x,y)}{\partial l} = |\operatorname{grad} f(x,y)| \cdot \cos(\bar{e}, \operatorname{grad} f(x,y))$$

bo'lishi kelib chiqadi.

Keyingi tenglikdan ko'rinadiki, \bar{e} hamda $\operatorname{grad} f(x,y)$ vektorlar parallel bo'lganda $\frac{\partial f(x,y)}{\partial l}$ ning qiymati eng katta va u

$$|\operatorname{grad} f(x,y)| = \sqrt{f_x'^2(x,y) + f_y'^2(x,y)}$$

ga teng bo'ladi.

Shunday qilib, $f(x,y)$ funksiyaning gradiyenti $\operatorname{grad} f$ funksiyaning (x,y) nuqtadagi eng tez o'sadigan tomonga yo'nalgan bo'lib, uning uzunligi shu yo'nalish bo'yicha o'sish tezligiga teng ekan.

3- misol. Ushbu $f(x,y) = x^2 + 2y^2$

funksiyaning $(1, 1)$ nuqtada eng tez o'sadigan yo'nalishi aniqlansin va shu yo'nalish bo'yicha o'sish tezligi topilsin.

◀ Ravshanki,

$$\frac{\partial f(x,y)}{\partial x} = \frac{\partial (x^2 + 2y^2)}{\partial x} = 2x, \quad \frac{\partial f(1,1)}{\partial x} = 2;$$

$$\frac{\partial f(x,y)}{\partial y} = \frac{\partial (x^2 + 2y^2)}{\partial y} = 4y, \quad \frac{\partial f(1,1)}{\partial y} = 4$$

bo'lib,

$$\operatorname{grad} f(1,1) = 2\bar{i} + 4\bar{j},$$

$$|\operatorname{grad} f(1,1)| = \sqrt{2^2 + 4^2} = 2\sqrt{5}$$

bo'ladi. ▶

Mashqlar

1. Aytaylik, $f(x)$ funksiya bog'lamli $E \in R^m$ to'plamda differensiallanuvchi bo'lsin. Agar E to'plamning har bir $x \in E \subset R^m$ nuqtasida $f(x)$ funksiyaning barcha xususiy hosilalari nolga teng bo'lsa, funksiya E to'plamda o'zgarmas bo'lishi isbotlansin.

2. Agar $f(x,y)$ funksiya $(0,0)$ nuqtada barcha yo'nalishlar bo'yicha hosilaga ega bo'lsa, $f(x,y)$ funksiya $(0,0)$ nuqtada differensiallanuvchi bo'ladimi?

61- ma'ruza

Ko'p o'zgaruvchili funktsiyaning differentsiali

1°. Funktsiya differentsiali tushunchasi. Faraz qilaylik, $f(x) = f(x_1, x_2, \dots, x_m)$ funktsiya $E \subset R^m$ da berilgan bo'lib, $x^0 = (x_1^0, x_2^0, \dots, x_m^0) \in E$ nuqtada differentsiallanuvchi bo'lsin. U holda ta'rifga ko'ra funktsiyaning x^0 nuqtadagi to'liq orttirmasi

$$\Delta f(x^0) = \frac{\partial f(x^0)}{\partial x_1} \Delta x_1 + \frac{\partial f(x^0)}{\partial x_2} \Delta x_2 + \dots + \frac{\partial f(x^0)}{\partial x_m} \Delta x_m + o(\rho) \quad (1)$$

bo'ladi. Bu munosabatda

$$\rho = \sqrt{\Delta x_1^2 + \Delta x_2^2 + \dots + \Delta x_m^2}$$

bo'lib, $\Delta x_1 \rightarrow 0, \Delta x_2 \rightarrow 0, \dots, \Delta x_m \rightarrow 0$ da $\rho \rightarrow 0$.

1- ta'rif. $f(x)$ funktsiyaning $\Delta f(x^0)$ orttirmasidagi

$$\frac{\partial f(x^0)}{\partial x_1} \Delta x_1 + \frac{\partial f(x^0)}{\partial x_2} \Delta x_2 + \dots + \frac{\partial f(x^0)}{\partial x_m} \Delta x_m$$

ifoda $f(x)$ funktsiyaning x^0 nuqtadagi differentsiali (to'liq differentsiali) deyiladi va

$$df(x^0) \text{ yoki } df(x_1^0, x_2^0, \dots, x_m^0)$$

kabi belgilanadi:

$$df(x^0) = \frac{\partial f(x^0)}{\partial x_1} \Delta x_1 + \frac{\partial f(x^0)}{\partial x_2} \Delta x_2 + \dots + \frac{\partial f(x^0)}{\partial x_m} \Delta x_m.$$

Demak, $f(x)$ funktsiyaning x^0 nuqtadagi differentsiali $\Delta x_1, \Delta x_2, \dots, \Delta x_m$ larga bog'liq va ularning chiziqli funktsiyasi bo'ladi.

Agar

$$\Delta x_1 = dx_1, \Delta x_2 = dx_2, \dots, \Delta x_m = dx_m$$

deyilsa, $f(x)$ funktsiyaning x^0 nuqtadagi differentsiali ushbu

$$df(x^0) = \frac{\partial f(x^0)}{\partial x_1} dx_1 + \frac{\partial f(x^0)}{\partial x_2} dx_2 + \dots + \frac{\partial f(x^0)}{\partial x_m} dx_m \quad (2)$$

ko'rinishga keladi. Demak,

$$\Delta f(x^0) = df(x^0) + o(\rho).$$

Keyingi tenglikdan $\rho \rightarrow 0$ da

$$\Delta f(x^0) \approx df(x^0)$$

bo'lishi kelib chiqadi. Bu taqribiy formulaning mohiyati shundaki, funksiyaning orttirmasi $\Delta x_1, \Delta x_2, \dots, \Delta x_m$ larning, umuman aytganda, murakkab funksiyasi bo'lgan holda funksiyaning differensial $\Delta x_1, \Delta x_2, \dots, \Delta x_m$ larning chiziqli funksiyasi bo'lishidadir.

2°. Murakkab funksiyaning differensial. Differensial shaklning invariantligi. Aytaylik,

$$\begin{aligned} x_1 &= \varphi_1(t) = \varphi_1(t_1, t_2, \dots, t_k), \\ x_2 &= \varphi_2(t) = \varphi_2(t_1, t_2, \dots, t_k), \\ &\dots\dots\dots \\ x_m &= \varphi_m(t) = \varphi_m(t_1, t_2, \dots, t_k) \end{aligned}$$

funksiyalarning har biri $M \in R^k$ to'plamda berilgan bo'lib,

$$E = \{(x_1, x_2, \dots, x_m) \in R^m : x_1 = \varphi_1(t) = \varphi_1(t_1, t_2, \dots, t_k), \\ x_2 = \varphi_2(t) = \varphi_2(t_1, t_2, \dots, t_k), \dots, x_m = \varphi_m(t) = \varphi_m(t_1, t_2, \dots, t_k)\}$$

to'plamda esa $f(x_1, x_2, \dots, x_m)$ funksiya aniqlangan bo'lsin. Bular yordamida

$$f(x(t)) = f(x_1(t), x_2(t), \dots, x_m(t)) = F(t_1, t_2, \dots, t_k)$$

murakkab funksiya hosil qilingan bo'lsin.

Ma'lumki, $x_i = \varphi_i(t_1, \dots, t_k)$ ($i=1,2,\dots,m$) funksiyalar $t^0 = (t_1^0, \dots, t_k^0)$ nuqtada differensiallanuvchi bo'lib, $f(x) = f(x_1, x_2, \dots, x_m)$ funksiya mos $x^0 = (x_1^0, x_2^0, \dots, x_m^0)$ nuqtada ($x_1^0 = \varphi_1(t^0), x_2^0 = \varphi_2(t^0), \dots, x_m^0 = \varphi_m(t^0)$) differensiallanuvchi bo'lsa, murakkab funksiya $t^0 = (t_1^0, \dots, t_k^0)$ nuqtada differensiallanuvchi bo'ladi.

Modomiki, $f(x(t))$ funksiya t_1, t_2, \dots, t_k o'zgaruvchilarga bog'liq ekan, u holda

$$\frac{\partial x_2}{\partial t_1} dt_1 + \frac{\partial x_2}{\partial t_2} dt_2 + \dots + \frac{\partial x_2}{\partial t_k} dt_k = dx_2,$$

$$\dots\dots\dots$$

$$\frac{\partial x_m}{\partial t_1} dt_1 + \frac{\partial x_m}{\partial t_2} dt_2 + \dots + \frac{\partial x_m}{\partial t_k} dt_k = dx_k.$$

Demak, murakkab funksiyaning differensialini

$$df = \frac{\partial f}{\partial x_1} dx_1 + \frac{\partial f}{\partial x_2} dx_2 + \dots + \frac{\partial f}{\partial x_m} dx_m \quad (4)$$

bo'ladi.

Biz yuqorida $f(x)$ hamda $f(x(t))$ murakkab funksiyaning differensiallari uchun (2) va (4) ifodalarni topdik. Bu ifodalarni solishtirib, ularning shakli (ko'rinishi) bir xil, ya'ni (2) va (4) formulalarda funksiyaning differensialini xususiy hosilalarning mos differensiallarga ko'paytmalaridan tuzilgan yig'indiga teng ekanligini payqaymiz. Bu xossa *differensial shaklining invariantligi* deyiladi.

E s l a t m a . $f(x)$ funksiya differensialining (2) ifodasidagi dx_1, dx_2, \dots, dx_m lar mos ravishda $\Delta x_1, \Delta x_2, \dots, \Delta x_m$ lar bo'lsa, $f(x(t))$ funksiya differensialidagi dx_1, dx_2, \dots, dx_m lar t_1, t_2, \dots, t_k o'zgaruvchilarning funksiyalari bo'ladi. Demak, (2) va (4) formulalarning ko'rinishlarigina bir xil bo'ladi.

3°. Sodda qoidalar. Aytaylik,

$$u = u(x_1, x_2, \dots, x_m), \quad v = v(x_1, x_2, \dots, x_m)$$

funksiyalar $E \in R^m$ to'plamda berilgan bo'lib, $x^0 = (x_1^0, x_2^0, \dots, x_m^0) \in E$ nuqtada differensiallanuvchi bo'lsin. U holda:

- 1) $d(u + v) = du + dv,$
- 2) $d(u \cdot v) = vdu + udv,$
- 3) $d\left(\frac{u}{v}\right) = \frac{vdu - udv}{v^2}, \quad (v \neq 0)$

bo'ladi.

Bu munosabatlardan birining, masalan, 3) ning isbotini keltiramiz.

◀ Aytaylik,
$$F = \frac{u}{v}$$

bo'lsin. Bu holda F funksiya u va v larga hamda u va v lar o'z

navbatida x_1, x_2, \dots, x_m o'zgaruvchilarga bog'liq bo'lib, murakkab funksiyaga ega bo'lamiz. Differensial shaklining invariantlik xossasiga ko'ra

$$dF = \frac{\partial F}{\partial u} du + \frac{\partial F}{\partial v} dv$$

bo'ladi. Ravshanki,

$$\frac{\partial F}{\partial u} = \frac{1}{v}, \quad \frac{\partial F}{\partial v} = -\frac{u}{v^2}.$$

Demak,
$$dF = \frac{1}{v} du - \frac{u}{v^2} dv = \frac{vdu - u dv}{v^2},$$

ya'ni
$$d\left(\frac{u}{v}\right) = \frac{vdu - u dv}{v^2}$$

bo'ladi. ►

4°. Xususiy hollar. Funksiya differensialining geometrik ma'nosi. Aytaylik, $m = 1$ bo'lsin. Bu holda $u = f(x)$, ($x \in R, u \in R$) funksiya va uning differensiali

$$du = df = f'(x)dx$$

ga ega bo'lamiz.

Ma'lumki, $u = f(x)$ funksiyaning differensiali shu funksiya tasvirlangan egri chiziqqa $(x_0, f(x_0))$ nuqtada o'tkazilgan urinma ordina-tasining orttirmasini ifodalaydi (27- chizma).

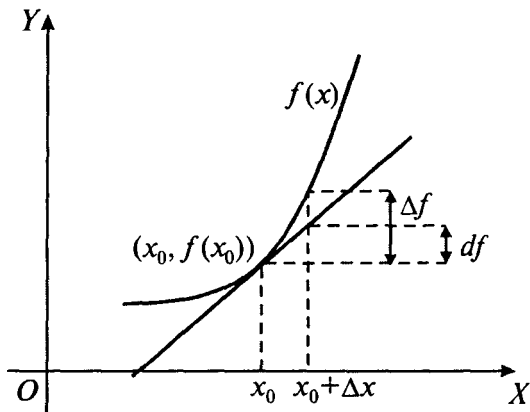

27- chizma.

$m = 2$ bo'lsin. Bu holda ikki o'zgaruvchili $u = f(x, y)$, $((x, y) \in R^2, u \in R)$ funksiyaga ega bo'lib, uning (x_0, y_0) nuqtadagi differensial

$$du = df(x_0, y_0) = \frac{\partial f(x_0, y_0)}{\partial x} dx + \frac{\partial f(x_0, y_0)}{\partial y} dy$$

bo'ladi, bunda $dx = \Delta x$, $dy = \Delta y$.

Δx va Δy lar yetarlicha kichik bo'lganda

$$\Delta f(x_0, y_0) \approx df(x_0, y_0),$$

ya'ni $f(x_0 + \Delta x, y_0 + \Delta y) \approx f(x_0, y_0) + \frac{\partial f(x_0, y_0)}{\partial x_1} \Delta x + \frac{\partial f(x_0, y_0)}{\partial y} \Delta y$

taqribiy formula hosil bo'ladi.

1- misol. Ushbu $u = x^y$ funksiyaning differensial topilsin.

◀ Ravshanki, $\frac{\partial u}{\partial x} = yx^{y-1}$, $\frac{\partial u}{\partial y} = x^y \ln x$.

U holda (5) formulaga ko'ra

$$du = yx^{y-1} dx + x^y \ln x dy$$

bo'ladi. ▶

2- misol. Tomonlari $x = 6$ m va $x = 8$ m bo'lgan to'g'ri to'rtburchak berilgan. Agar bu to'g'ri to'rtburchakning x tomonini 5 sm ga oshirilsa, y tomonini 10 sm ga kamaytirilsa, to'rtburchakning diagonali qanchaga o'zgaradi?

◀ Agar berilgan to'g'ri to'rtburchakning diagonalini u desak, unda

$$u = \sqrt{x^2 + y^2}$$

bo'ladi. Endi

$$\Delta u(x_0, y_0) \approx \frac{x_0}{\sqrt{x_0^2 + y_0^2}} \Delta x + \frac{y_0}{\sqrt{x_0^2 + y_0^2}} \Delta y$$

bo'lishini e'tiborga olib, topamiz:

$$\Delta u(x_0, y_0) \approx \frac{x_0}{\sqrt{x_0^2 + y_0^2}} \cdot \Delta x + \frac{y_0}{\sqrt{x_0^2 + y_0^2}} \cdot \Delta y = \frac{x_0 \Delta x + y_0 \Delta y}{\sqrt{x_0^2 + y_0^2}}$$

Bu munosabatda

$x_0 = 6 \text{ m}$, $\Delta x = 0,05 \text{ m}$, $y_0 = 8 \text{ m}$, $\Delta y = -0,10 \text{ m}$
deyilsa, u holda

$$\Delta u \approx \frac{6 \cdot 0,06 + 8 \cdot (-0,10)}{\sqrt{36+64}} \text{ m} = -0,05 \text{ m}$$

bo'lishi kelib chiqadi.

Demak, to'g'ri to'rtburchakning diagonali taxminan 5 sm ga kamayar ekan. ►

Endi $f(x, y)$ funksiya differensialining geometrik ma'nosini keltiramiz.

Aytaylik,
$$z = f(x, y)$$

funksiya ochiq $E \in R^2$ to'plamda differensialnuvchi bo'lsin. Bu funksiya grafigi R^3 fazoda biror $\Gamma(f)$ sirtini ifodalasin. $\Gamma(f) = \{(x, y, z) \in R^3 : (x, y) \in E, z = f(x, y)\}$ sirtida $(x_0, y_0, z_0) \in \Gamma(f)$, $(z_0 = f(x_0, y_0))$ nuqtani va shu nuqtadan o'tuvchi, qaralayotgan sirtga tegishli bo'lgan silliq

$$\Gamma = \{x = x(t), y = y(t), z = z(t) : \alpha \leq t \leq \beta\}$$

egri chiziqni olamiz. Modomiki, egri chiziq sirtida yotar ekan, u holda

$$z(t) = f(x(t), y(t)),$$

$$((x(t_0), y(t_0), z(t_0)) = (x_0, y_0, z_0), t_0 \in (\alpha, \beta))$$

bo'ladi. Ravshanki,

$$z(t) = f(x(t), y(t))$$

murakkab funksiya bo'lib, uning t_0 nuqtadagi differensial, differensial shaklining invariantlik xossasiga binoan, ushbu

$$df(x_0, y_0) = dz = \frac{\partial f(x_0, y_0)}{\partial x} dx + \frac{\partial f(x_0, y_0)}{\partial y} dy \quad (6)$$

ko'rinishga ega.

Koordinatalari dx, dy, dz bo'lgan vektor Γ egri chiziqqa (x_0, y_0, z_0) nuqtada o'tkazilgan urinma vektor bo'ladi.

Endi koordinatalari

$$-\frac{\partial f(x_0, y_0)}{\partial x}, -\frac{\partial f(x_0, y_0)}{\partial y}, 1$$

bo'lgan \vec{n} vektorni qaraylik. Yuqoridagi (6) munosabat \vec{n} vektor urinma vektorga (x_0, y_0, z_0) nuqtada ortogonal bo'lishini bildiradi. Shuning uchun \vec{n} vektor egri chiziqqa (x_0, y_0, z_0) nuqtada ortogonal deyiladi.

Ma'lumki, Γ egri chiziq (x_0, y_0, z_0) nuqtadan o'tuvchi va $\Gamma(f)$ sirtta yotuvchi ixtiyoriy egri chiziq edi. Binobarin, \vec{n} vektor shu (x_0, y_0, z_0) nuqtadan o'tuvchi va $\Gamma(f)$ sirtta yotuvchi ixtiyoriy egri chiziqqa ortogonal bo'ladi. Shuning uchun \vec{n} vektor $\Gamma(f)$ sirtning (x_0, y_0, z_0) nuqtasidagi normal vektori deyiladi.

Sirtning (x_0, y_0, z_0) nuqtasidan o'tuvchi va sirtning normal vektoriga ortogonal bo'lgan tekislik, $\Gamma(f)$ sirtga (x_0, y_0, z_0) nuqtada o'tkazilgan *urinma tekislik* deyiladi. Uning tenglamasi

$$Z - z_0 = \frac{\partial f(x_0, y_0)}{\partial x} (X - x_0) + \frac{\partial f(x_0, y_0)}{\partial y} (Y - y_0)$$

bo'ladi, bunda (X, Y, Z) urinma tekislikdagi o'zgaruvchi nuqta. Bu tenglikdan foydalanib,

$$Z - z_0 = \frac{\partial f(x_0, y_0)}{\partial x} (x - x_0) + \frac{\partial f(x_0, y_0)}{\partial y} (y - y_0)$$

ifodani olamiz. Keltirilgan tenglik va (6) munosabatlardan

$$df(x_0, y_0) = Z - z_0$$

bo'lishi kelib chiqadi.

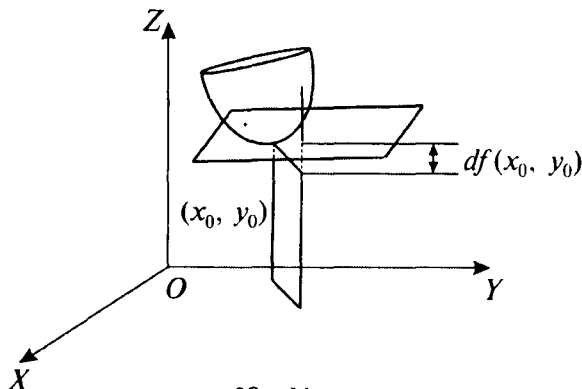

28- chizma.

Shunday qilib, $z = f(x, y)$ funksiyaning (x_0, y_0) nuqtadagi differensial $df(x_0, y_0)$ bu funksiya grafigiga $(x_0, y_0, f(x_0, y_0))$ nuqtadagi urinma tekislik applikatasining orttirmasini ifodalay ekan (28- chizma).

Mashqlar

1. Ushbu $f\left(x^2 + y^2, \arctg \frac{y}{x}\right)$, $(x^2 + y^2 > 0)$

funksiyaning differensialini topilsin.

2. Ushbu $\alpha = (1, 02)^{3,01}$ miqdorning taqribiy qiymati topilsin.

62- ma'ruza

Ko'p o'zgaruvchili funksiyaning yuqori tartibli hosila va differensiallari. Teylor formulasi

1°. Yuqori tartibli xususiy hosilalar. Faraz qilaylik, $f(x) = f(x_1, x_2, \dots, x_m)$ funksiya ochiq $E \subset R^m$ to'plamning har bir $x = (x_1, x_2, \dots, x_m) \in E$ nuqtasida

$$\frac{\partial f(x)}{\partial x_i} = f'_{x_i}, \quad (i = 1, 2, \dots, m)$$

xususiy hosilalarga ega bo'lsin. Bu xususiy hosilalar x_1, x_2, \dots, x_m o'zgaruvchilarning funksiyasi bo'lib, ular ham xususiy hosilalarga ega bo'lishi mumkin:

$$\frac{\partial}{\partial x_k} \left(\frac{\partial f(x)}{\partial x_i} \right) = (f'_{x_i}(x))'_{x_k}, \quad (i, k = 1, 2, \dots, m).$$

Bu xususiy hosilalar berilgan $f(x)$ funksiyaning ikkinchi tartibli xususiy hosilalari deyiladi va

$$\frac{\partial^2 f(x)}{\partial x_k \partial x_i} \text{ yoki } f''_{x_i x_k}(x), \quad (i, k = 1, 2, \dots, m)$$

kabi belgilanadi:

$$\frac{\partial^2 f(x)}{\partial x_k \partial x_i} = f''_{x_i x_k}(x) = \frac{\partial}{\partial x_k} \left(\frac{\partial f(x)}{\partial x_i} \right).$$

Agar $i \neq k$ bo'lsa, $\frac{\partial^2 f(x)}{\partial x_k \partial x_i}$

ikkinchi tartibli xususiy hosila *aralash hosila* deyiladi.

Agar $i = k$ bo'lsa, ikkinchi tartibli

$$\frac{\partial^2 f(x)}{\partial x_k \partial x_i} = f''_{x_i x_k}(x)$$

xususiy hosilalar quyidagicha yoziladi:

$$\frac{\partial^2 f(x)}{\partial x_i^2} = f''_{x_i^2}(x).$$

$f(x)$ funksiyaning uchinchi, to'rtinchi va h.k. tartibdagi xususiy hosilalari xuddi yuqoridagiga o'xshash ta'riflanadi. Umuman, $f(x) = f(x_1, x_2, \dots, x_m)$ funksiyaning $x_i, x_{i_2}, \dots, x_{i_{n-1}}, x_{i_n}$ o'zgaruvchilar bo'yicha n - tartibli xususiy hosilasi berilgan funksiyaning $(n - 1)$ - tartibli xususiy hosilasi

$$\frac{\partial^{n-1} f(x)}{\partial x_{i_{n-1}} \partial x_{i_{n-2}} \dots \partial x_{i_1}}, \quad (i_1 + i_2 + \dots + i_{n-1} = n - 1)$$

ning x_{i_n} o'zgaruvchi bo'yicha xususiy hosilasi sifatida ta'riflanadi:

$$\frac{\partial^n f(x)}{\partial x_{i_n} \partial x_{i_{n-1}} \dots \partial x_{i_2} \partial x_{i_1}} = \frac{\partial}{\partial x_{i_n}} \left(\frac{\partial^{n-1} f(x)}{\partial x_{i_{n-1}} \dots \partial x_{i_2} \partial x_{i_1}} \right).$$

Bu holda ham i_1, i_2, \dots, i_n lar bir-biriga teng bo'lmaganda

$$\frac{\partial^n f}{\partial x_{i_n} \dots \partial x_{i_2} \partial x_{i_1}}$$

aralash hosila deyiladi.

Agar $i_1 = i_2 = \dots = i_n = k$ bo'lsa, n - tartibli xususiy hosilalar quyidagicha yoziladi:

$$\frac{\partial^n f(x)}{\partial x_k^n}.$$

Ushbu $\frac{\partial^2 f}{\partial x_k \partial x_i}, \frac{\partial^2 f}{\partial x_i \partial x_k}, (i \neq k)$

aralash hosilalar funksiyaning turli o'zgaruvchilari bo'yicha differensiallash tartibi bilan farq qiladi:

$$\frac{\partial^2 f}{\partial x_k \partial x_i}$$

da $f(x_1, x_2, \dots, x_m)$ funksiyaning avval x_i o'zgaruvchi bo'yicha, so'ngra x_k o'zgaruvchi bo'yicha xususiy hosilasi hisoblangan bo'lsa,

$$\frac{\partial^2 f}{\partial x_i \partial x_k}$$

ifodada esa avval x_k o'zgaruvchi bo'yicha, so'ngra x_i o'zgaruvchi bo'yicha xususiy hosila hisoblangan. Ular bir-biriga teng ham bo'lishi mumkin, teng bo'lmasdan qolishi ham mumkin (misollar keyingi badda keltiriladi).

Aralash hisilalarning tengligini quyidagi teorema ifodalaydi.

1- teorema. Faraz qilaylik, $f(x_1, x_2, \dots, x_m)$ funksiya $x^0 = (x_1^0, x_2^0, \dots, x_m^0) \in E \subset R^m$ nuqtada n marta differensiallanuvchi bo'lsin. U holda x^0 nuqtada $f(x_1, x_2, \dots, x_m)$ funksiya ixtiyoriy n - tartibli aralash hosilalarining qiymati x_1, x_2, \dots, x_m o'zgaruvchilar bo'yicha qanday tartibda differensiallanishiga bog'liq bo'lmaydi.

◀ Bu teoremaning isboti, keyingi badda ikki o'zgaruvchili funksiya uchun keltiriladigan teorema isboti kabi bo'ladi. ▶

2°. Yuqori tartibli differensiallar. Faraz qilaylik, $f(x) = f(x_1, x_2, \dots, x_m)$ funksiya ochiq $E \subset R^m$ to'plamda berilgan, $x \in E$ nuqtada ikki marta differensiallanuvchi bo'lsin.

1- ta'rif. $f(x)$ funksiya differensial $df(x)$ ning differensial berilgan funksiyaning x nuqtadagi ikkinchi tartibli differensial deyiladi va $d^2f(x)$ kabi belgilanadi:

$$d^2 f(x) = d(df(x)).$$

Endi funksiya ikkinchi tartibli differensialini uning xususiy hosilalari orqali ifodalanishini ko'rsatamiz.

Ravshanki,

$$df(x) = \frac{\partial f(x)}{\partial x_1} dx_1 + \frac{\partial f(x)}{\partial x_2} dx_2 + \dots + \frac{\partial f(x)}{\partial x_m} dx_m$$

bo'lib, u $x = (x_1, x_2, \dots, x_m)$ ga hamda dx_1, dx_2, \dots, dx_m larga bog'liq bo'ladi. Bu tenglikda dx_1, dx_2, \dots, dx_m larni tayinlangan deb hisoblab,

$df(x)$ ni x_1, x_2, \dots, x_m o'zgaruvchilarning funksiyasi sifatida qarab, uning differensialini topamiz:

$$\begin{aligned}
 d(df) &= d\left(\frac{\partial f}{\partial x_1} dx_1 + \frac{\partial f}{\partial x_2} dx_2 + \dots + \frac{\partial f}{\partial x_m} dx_m\right) = \\
 &= dx_1 \left[\frac{\partial}{\partial x_1} \left(\frac{\partial f}{\partial x_1}\right) \cdot dx_1 + \frac{\partial}{\partial x_2} \left(\frac{\partial f}{\partial x_1}\right) \cdot dx_2 + \dots + \frac{\partial}{\partial x_m} \left(\frac{\partial f}{\partial x_1}\right) \cdot dx_m \right] + \\
 &+ dx_2 \left[\frac{\partial}{\partial x_1} \left(\frac{\partial f}{\partial x_2}\right) \cdot dx_1 + \frac{\partial}{\partial x_2} \left(\frac{\partial f}{\partial x_2}\right) dx_2 + \dots + \frac{\partial}{\partial x_m} \left(\frac{\partial f}{\partial x_2}\right) dx_m \right] + \dots + \\
 &\dots \dots \dots \\
 &+ dx_m \left[\frac{\partial}{\partial x_1} \left(\frac{\partial f}{\partial x_m}\right) dx_1 + \frac{\partial}{\partial x_2} \left(\frac{\partial f}{\partial x_m}\right) dx_2 + \dots + \frac{\partial}{\partial x_m} \left(\frac{\partial f}{\partial x_m}\right) dx_m \right] = \\
 &= \frac{\partial^2 f}{\partial x_1^2} dx_1^2 + \frac{\partial^2 f}{\partial x_2^2} dx_2^2 + \dots + \frac{\partial^2 f}{\partial x_m^2} dx_m^2 + 2 \left[\frac{\partial^2 f}{\partial x_1 \partial x_2} dx_1 dx_2 + \right. \\
 &+ \frac{\partial^2 f}{\partial x_1 \partial x_3} dx_1 dx_3 + \dots + \frac{\partial^2 f}{\partial x_1 \partial x_m} dx_1 dx_m + \frac{\partial^2 f}{\partial x_2 \partial x_3} dx_2 dx_3 + \frac{\partial^2 f}{\partial x_2 \partial x_4} dx_2 dx_4 + \\
 &\left. + \dots + \frac{\partial^2 f}{\partial x_2 \partial x_m} dx_2 dx_m + \dots + \frac{\partial^2 f}{\partial x_{m-1} \partial x_m} dx_{m-1} dx_m \right] = \\
 &= \left(\frac{\partial}{\partial x_1} dx_1 + \frac{\partial}{\partial x_2} dx_2 + \dots + \frac{\partial}{\partial x_m} dx_m \right)^2 f.
 \end{aligned}$$

Bunda simbolik yozuvdan foydalaniladi. U quyidagicha tushuniladi: qavs ichidagi yig'indi kvadratga ko'tarilib, so'ng f ga «ko'paytiriladi». Keyin daraja ko'rsatkichlari xususiy hosilalar tartibi deb hisoblanadi. Demak,

$$d^2 f(x) = \left(\frac{\partial}{\partial x_1} dx_1 + \frac{\partial}{\partial x_2} dx_2 + \dots + \frac{\partial}{\partial x_m} dx_m \right)^2 f. \quad (1)$$

$f(x)$ funksiyaning x nuqtadagi uchinchi, to'rtinchi va h.k. tartibdagi differensiallari ham yuqoridagidek ta'riflanadi.

Umuman, $f(x)$ funksiyaning x nuqtadagi $(n-1)$ - tartibli differensial $d^{n-1}f(x)$ ning differensial $f(x)$ ning n - tartibli differensial deyiladi va $d^n f(x)$ kabi belgilanadi:

$$d^n f(x) = d(d^{n-1} f(x)).$$

Agar $f(x)$ funksiya x nuqtada n marta differensialanuvchi bo'lsa, u holda

$$d^n f(x) = \left(\frac{\partial}{\partial x_1} dx_1 + \frac{\partial}{\partial x_2} dx_2 + \dots + \frac{\partial}{\partial x_m} \right)^n f \quad (2)$$

bo'ladi.

3°. Murakkab funksiyaning yuqori tartibli differensiallari. Biz yuqorida funksiyaning yuqori tartibli differensiallarini bayon etdik. Unda funksiya argumenti x_1, x_2, \dots, x_m lar erkli o'zgaruvchilar edi.

Aytaylik, $f(x) = f(x_1, x_2, \dots, x_m)$ funksiya x_1, x_2, \dots, x_m o'zgaruvchilarning har biri t_1, t_2, \dots, t_k o'zgaruvchilarning funksiyalari bo'lsin ($x_i = \varphi_i(t_1, t_2, \dots, t_k)$).

Qaralayotgan $f(x)$ va $x_i = \varphi_i(t)$, ($i = 1, 2, \dots, m$) funksiyalar n marta differensiallanuvchanlik shartlarini bajargan deb, murakkab $f(x(t))$ funksiyaning yuqori tartibli differensiallarini hisoblaymiz.

Ma'lumki, differensial shaklining invariantligi xossasiga binoan, murakkab funksiyaning differensial

$$df = \frac{\partial f}{\partial x_1} dx_1 + \frac{\partial f}{\partial x_2} dx_2 + \dots + \frac{\partial f}{\partial x_m} dx_m$$

bo'ladi. Differensiallash qoidalaridan foydalanib funksiyaning ikkinchi tartibli differensialini topamiz:

$$\begin{aligned} d^2 f &= d(df) = d\left(\frac{\partial f}{\partial x_1} dx_1 + \frac{\partial f}{\partial x_2} dx_2 + \dots + \frac{\partial f}{\partial x_m} dx_m\right) = \\ &= d\left(\frac{\partial f}{\partial x_1} dx_1\right) + d\left(\frac{\partial f}{\partial x_2} dx_2\right) + \dots + d\left(\frac{\partial f}{\partial x_m} dx_m\right) = \\ &= d\left(\frac{\partial f}{\partial x_1}\right) \cdot dx_1 + \frac{\partial f}{\partial x_1} d(dx_1) + d\left(\frac{\partial f}{\partial x_2}\right) \cdot dx_2 + \frac{\partial f}{\partial x_2} \cdot d(dx_2) + \dots + \\ &\quad + d\left(\frac{\partial f}{\partial x_m}\right) \cdot dx_m + \frac{\partial f}{\partial x_m} d(dx_m) = \\ &= d\left(\frac{\partial f}{\partial x_1}\right) \cdot dx_1 + d\left(\frac{\partial f}{\partial x_2}\right) dx_2 + \dots + d\left(\frac{\partial f}{\partial x_m}\right) dx_m + \\ &\quad + \frac{\partial f}{\partial x_1} d^2 x_1 + \frac{\partial f}{\partial x_2} d^2 x_2 + \dots + \frac{\partial f}{\partial x_m} d^2 x_m = \\ &= \left(\frac{\partial}{\partial x_1} dx_1 + \frac{\partial}{\partial x_2} dx_2 + \dots + \frac{\partial}{\partial x_m} dx_m\right)^2 f + \frac{\partial f}{\partial x_1} d^2 x_1 + \frac{\partial f}{\partial x_2} d^2 x_2 + \dots + \frac{\partial f}{\partial x_m} d^2 x_m. \end{aligned}$$

Demak,

$$d^2f = \left(\frac{\partial}{\partial x_1} dx_1 + \frac{\partial}{\partial x_2} dx_2 + \dots + \frac{\partial}{\partial x_m} dx_m \right)^2 f + \frac{\partial f}{\partial x_1} d^2x_1 + \frac{\partial f}{\partial x_2} d^2x_2 + \dots + \frac{\partial f}{\partial x_m} d^2x_m. \quad (3)$$

Shu yo'l bilan berilgan murakkab funktsiyaning keyingi tartibdagi differentsiallari topiladi.

1-eslatma. (1) va (3) formulalarni solishtirib, ikkinchi tartibli differentsiallarda differentsial shaklning invariantligi xossasi o'rinli emasligini ko'ramiz.

2-eslatma. Agar $f(x_1, x_2, \dots, x_m)$ funktsiya argumentlari x_1, x_2, \dots, x_m larning har biri t_1, t_2, \dots, t_k o'zgaruvchilarning chiziqli funktsiyasi bo'lsa, u holda $f(x)$ funktsiyaning ikkinchi tartibli (umuman, n - tartibli) differentsiali differentsial shaklning invariantlik xossasiga ega bo'ladi.

◀ Aytaylik,

$$x_i = b_i + a_{i_1} t_1 + a_{i_2} t_2 + \dots + a_{i_k} t_k, \quad (i = 1, 2, \dots, k)$$

bo'lsin. U holda, ravshanki,

$$d^2t_1 = d^2t_2 = \dots = d^2t_k = 0$$

bo'lib,

$$d^2x_i = a_{i_1} d^2t_1 + a_{i_2} d^2t_2 + \dots + a_{i_k} d^2t_k = 0$$

bo'ladi. (3) formuladan foydalanib topamiz:

$$d^2f = \left(\frac{\partial}{\partial x_1} dx_1 + \frac{\partial}{\partial x_2} dx_2 + \dots + \frac{\partial}{\partial x_m} dx_m \right)^2 f.$$

Bu esa d^2f ning (1) formula ko'rinishiga ega ekanligini bildiradi. ▶

4°. Ko'p o'zgaruvchili funktsiyaning Teylor formulasi. Aytaylik, $f(x) = f(x_1, x_2, \dots, x_m)$ funktsiya ochiq $E \subset R^m$ to'plamda berilgan bo'lib, $U_\delta(x^0) \subset E$ bo'lsin, bunda $x^0 = (x_1^0, x_2^0, \dots, x_m^0)$ va $\delta > 0$. Ravshanki,

$$\forall x = (x_1, x_2, \dots, x_m) \in U_\delta(x^0), \quad x^0 = (x_1^0, x_2^0, \dots, x_m^0)$$

nuqtalarni birlashtiruvchi to'g'ri chiziq kesmasi

$A = \{x_1^0 + t(x_1 - x_1^0), x_2^0 + t(x_2 - x_2^0), \dots, x_m^0 + t(x_m - x_m^0)\}; 0 \leq t \leq 1\}$
 shu $U_\delta(x^0)$ ga tegishli bo'ladi.

Faraz qilaylik, $f(x_1, x_2, \dots, x_m)$ funksiya $U_\delta(x^0)$ to'plamda $(n+1)$ marta differentsiallanuvchi bo'lsin. Bu funksiyani A to'plamda qarasaq, $[0, 1]$ segmentda aniqlangan ushbu

$F(t) = f(x_1^0 + t(x_1 - x_1^0), x_2^0 + t(x_2 - x_2^0), \dots, x_m^0 + t(x_m - x_m^0))$
 funksiyaga ega bo'lamiz. $F(t)$ funksiya $[0, 1]$ da hosilaga ega bo'lib,

$$F'(t) = \frac{\partial f}{\partial x_1} \cdot (x_1 - x_1^0) + \frac{\partial f}{\partial x_2} \cdot (x_2 - x_2^0) + \dots + \frac{\partial f}{\partial x_m} \cdot (x_m - x_m^0) =$$

$$= \left(\frac{\partial}{\partial x_1} \cdot (x_1 - x_1^0) + \frac{\partial}{\partial x_2} \cdot (x_2 - x_2^0) + \dots + \frac{\partial}{\partial x_m} \cdot (x_m - x_m^0) \right) f$$

bo'ladi, bunda $f(x)$ funksiyaning barcha xususiy hosilalari

$$(x_1^0 + t(x_1 - x_1^0), x_2^0 + t(x_2 - x_2^0), \dots, x_m^0 + t(x_m - x_m^0)) \quad (4)$$

nuqtada hisoblangan.

Umuman, hosil qilingan $F(t)$ funksiya k - tartibli ($k = 1, 2, \dots, n+1$) hosilalarga ega va u

$$F^{(k)}(t) = \left(\frac{\partial}{\partial x_1} \cdot (x_1 - x_1^0) + \frac{\partial}{\partial x_2} \cdot (x_2 - x_2^0) + \dots + \frac{\partial}{\partial x_m} \cdot (x_m - x_m^0) \right)^k f$$

ga teng, bundagi barcha xususiy hosilalar (4) nuqtada hisoblangan. Bu munosabatning to'g'riligi matematik induksiya usuli yordamida isbotlanadi.

Shunday qilib, $F(t)$ funksiya $F'(t), F''(t), \dots, F^{(n+1)}(t)$ hosilalarga ega bo'ladi. Teylor formulasiga ko'ra (qaralsin, 24- ma'ruza) t_0 nuqtada ($0 \leq t_0 \leq 1$)

$$F(t) = F(t_0) + F'(t_0)(t - t_0) + \frac{1}{2!} F''(t_0)(t - t_0)^2 + \dots +$$

$$+ \frac{1}{n!} F^{(n)}(t_0) \cdot (t - t_0)^n + \frac{1}{(n+1)!} F^{(n+1)}(c) \cdot (t - t_0)^{n+1} \quad (5)$$

bo'ladi, bunda $c = t_0 + \theta(t - t_0)$, $0 < \theta < 1$. Bu tenglikda $t_0 = 0$, $t = 1$ deyilsa, u holda

$$F(1) = F(0) + \frac{1}{1!} F'(0) + \frac{1}{2!} F''(0) + \dots + \frac{1}{n!} F^{(n)}(0) + \frac{1}{(n+1)!} F^{(n+1)}(\theta)$$

bo'lishi kelib chiqadi.

Ayni paytda,

$$F(0) = f(x_1^0, x_2^0, \dots, x_m^0),$$

$$F(1) = f(x_1, x_2, \dots, x_m),$$

$$F^{(k)}(0) = \left(\frac{\partial}{\partial x_1} \cdot (x_1 - x_1^0) + \frac{\partial}{\partial x_2} \cdot (x_2 - x_2^0) + \dots + \frac{\partial}{\partial x_m} \cdot (x_m - x_m^0) \right)^k f \quad (6)$$

(bunda f funksiyaning barcha xususiy hosilalari $(x_1^0, x_2^0, \dots, x_m^0)$ nuqtada hisoblangan) bo'lishini e'tiborga olsak, u holda (5) va (6) tengliklardan ushbu

$$\begin{aligned} f(x_1, x_2, \dots, x_m) &= f(x_1^0, x_2^0, \dots, x_m^0) + \sum_{k=1}^n \frac{1}{k!} \times \\ &\times \left(\frac{\partial}{\partial x_1} \cdot (x_1 - x_1^0) + \frac{\partial}{\partial x_2} \cdot (x_2 - x_2^0) + \dots + \frac{\partial}{\partial x_m} \cdot (x_m - x_m^0) \right)^k f(x_1^0, x_2^0, \dots, x_m^0) + \\ &+ \frac{1}{(n+1)!} \left(\frac{\partial}{\partial x_1} \cdot (x_1 - x_1^0) + \frac{\partial}{\partial x_2} \cdot (x_2 - x_2^0) + \dots + \frac{\partial}{\partial x_m} \cdot (x_m - x_m^0) \right)^{n+1} \times \\ &\times f(x_1^0 + \theta(x_1 - x_1^0), x_2^0 + \theta(x_2 - x_2^0), \dots, x_m^0 + \theta(x_m - x_m^0)) \end{aligned}$$

($0 < \theta < 1$) tenglikka kelamiz. Bu ifoda ko'p o'zgaruvchili $f(x_1, x_2, \dots, x_m)$ funksiyaning *Lagranj ko'rinishidagi qoldiq hadli Teylor formulasi* deyiladi.

5°. Xususiy hollar. Aralash hosilaning tengligi haqida teorema.
 $m = 1$ bo'lsin. Bu holda $u = f(x)$ ($x \in R, u \in R$) funksiyaning yuqori tartibli hosila va differensiallariga kelamiz. Ular 23- ma'ruzada batafsil bayon etilgan.

$m = 2$ bo'lganda $u = f(x, y)$, $((x, y) \in R^2, u \in R)$ ikki o'zgaruvchili funksiya bo'lib, uning ikkinchi tartibli xususiy hosilalari (ular 4 ta bo'ladi) quyidagicha bo'ladi:

$$\frac{\partial^2 f(x, y)}{\partial x^2} = \frac{\partial}{\partial x} \left(\frac{\partial f(x, y)}{\partial x} \right), \quad \frac{\partial^2 f(x, y)}{\partial y \partial x} = \frac{\partial}{\partial y} \left(\frac{\partial f(x, y)}{\partial x} \right),$$

$$\frac{\partial^2 f(x, y)}{\partial x \partial y} = \frac{\partial}{\partial x} \left(\frac{\partial f(x, y)}{\partial y} \right), \quad \frac{\partial^2 f(x, y)}{\partial y^2} = \frac{\partial}{\partial y} \left(\frac{\partial f(x, y)}{\partial y} \right).$$

1- misol. Ushbu $f(x, y) = \arctg \frac{x}{y}$, ($y \neq 0$)

funksiyaning ikkinchi tartibli xususiy hosilalari topilsin.

◀ Ravshanki,

$$\frac{\partial f}{\partial x} = \frac{1}{1 + \frac{x^2}{y^2}} \cdot \frac{1}{y} = \frac{y}{x^2 + y^2}, \quad \frac{\partial f}{\partial y} = \frac{1}{1 + \frac{x^2}{y^2}} \cdot \left(-\frac{x}{y^2}\right) = -\frac{x}{x^2 + y^2}$$

bo'ladi.

Endi ta'rifdan foydalanib, berilgan funksiyaning ikkinchi tartibli xususiy hosilalarini topamiz:

$$\frac{\partial^2 f}{\partial x^2} = \frac{\partial}{\partial x} \left(\frac{y}{x^2 + y^2} \right) = -\frac{2xy}{(x^2 + y^2)^2},$$

$$\frac{\partial^2 f}{\partial y \partial x} = \frac{\partial}{\partial y} \left(\frac{y}{x^2 + y^2} \right) = \frac{x^2 - y^2}{(x^2 + y^2)^2},$$

$$\frac{\partial^2 f}{\partial x \partial y} = \frac{\partial}{\partial x} \left(-\frac{x}{x^2 + y^2} \right) = \frac{x^2 - y^2}{(x^2 + y^2)^2},$$

$$\frac{\partial^2 f}{\partial y^2} = \frac{\partial}{\partial y} \left(-\frac{x}{x^2 + y^2} \right) = \frac{2xy}{(x^2 + y^2)^2}. \quad \blacktriangleright$$

2- misol. Ushbu

$$f(x, y) = \begin{cases} xy \frac{x^2 - y^2}{x^2 + y^2}, & \text{agar } x^2 + y^2 > 0 \text{ bo'lsa,} \\ 0, & \text{agar } x^2 + y^2 = 0 \text{ bo'lsa,} \end{cases}$$

funksiyaning (0, 0) nuqtadagi aralash hosilalari topilsin.

Ayтайlik, $(x, y) \neq (0, 0)$ bo'lsin. Bu holda

$$\frac{\partial f}{\partial x} = y \left(\frac{x^2 - y^2}{x^2 + y^2} + \frac{4x^2 y^2}{(x^2 + y^2)^2} \right), \quad \frac{\partial f}{\partial y} = x \left(\frac{x^2 - y^2}{x^2 + y^2} - \frac{4x^2 y^2}{(x^2 + y^2)^2} \right),$$

$$\frac{\partial^2 f}{\partial y \partial x} = \frac{\partial}{\partial y} \left(\frac{\partial f}{\partial x} \right) = \frac{x^2 - y^2}{x^2 + y^2} \cdot \left(1 + \frac{8x^2 y^2}{(x^2 + y^2)^2} \right),$$

$$\frac{\partial^2 f}{\partial x \partial y} = \frac{\partial}{\partial x} \left(\frac{\partial f}{\partial y} \right) = \frac{x^2 - y^2}{x^2 + y^2} \cdot \left(1 + \frac{8x^2 y^2}{(x^2 + y^2)^2} \right)$$

bo'ladi.

Aytaylik, $(x, y) = (0, 0)$ bo'lsin. Bu holda funksiyaning hosilalarini ta'rifga ko'ra hisoblaymiz:

$$\frac{\partial f(0,0)}{\partial x} = \lim_{\Delta x \rightarrow 0} \frac{f(\Delta x, 0) - f(0, 0)}{\Delta x} = 0,$$

$$\frac{\partial f(0,0)}{\partial y} = \lim_{\Delta y \rightarrow 0} \frac{f(0, \Delta y) - f(0, 0)}{\Delta y} = 0,$$

$$\frac{\partial^2 f(0,0)}{\partial y \partial x} = \lim_{\Delta y \rightarrow 0} \frac{\frac{\partial f(0, \Delta y)}{\partial x} - \frac{\partial f(0, 0)}{\partial x}}{\Delta y} = \lim_{\Delta y \rightarrow 0} \frac{-\Delta y^3}{\Delta y^3} = -1,$$

$$\frac{\partial^2 f(0,0)}{\partial x \partial y} = \lim_{\Delta x \rightarrow 0} \frac{\frac{\partial f(\Delta x, 0)}{\partial y} - \frac{\partial f(0, 0)}{\partial y}}{\Delta x} = \lim_{\Delta x \rightarrow 0} \frac{-\Delta x^3}{\Delta x^3} = 1. \blacktriangleright$$

Yuqorida keltirilgan misollardan ko'rinadiki, $f(x, y)$ funksiyaning

$$\frac{\partial^2 f}{\partial x \partial y}, \quad \frac{\partial^2 f}{\partial y \partial x}$$

aralash hosilalari bir-biriga teng ham bo'lishi mumkin, teng bo'lmasdan qolishi ham mumkin ekan.

2- teorema. Faraz qilaylik, $f(x, y)$ funksiya $(x_0, y_0) \in R^2$ nuqtaning $U_\delta((x_0, y_0))$ atrofida

$$\frac{\partial^2 f(x, y)}{\partial x \partial y}, \quad \frac{\partial^2 f(x, y)}{\partial y \partial x}, \quad ((x, y) \in U_\delta((x_0, y_0)))$$

aralash hosilalarga ega bo'lib, bu hosilalar (x_0, y_0) nuqtada uzluksiz bo'lsin. U holda $f(x, y)$ funksiyaning aralash hosilalari (x_0, y_0) nuqtada teng bo'ladi:

$$\frac{\partial^2 f(x_0, y_0)}{\partial y \partial x} = \frac{\partial^2 f(x_0, y_0)}{\partial x \partial y}.$$

◀ Aytaylik, $(x_0 + \Delta x, y_0 + \Delta y)$, $(x_0 + \Delta x, y_0)$, $(x_0, y_0 + \Delta y)$ nuqtalar (x_0, y_0) nuqtaning atrofiga tegishli bo'lsin:

$$(x_0 + \Delta x, y_0 + \Delta y) \in U_\delta((x_0, y_0)), \quad (x_0 + \Delta x, y_0) \in U_\delta((x_0, y_0)), \\ (x_0, y_0 + \Delta y) \in U_\delta((x_0, y_0)).$$

Ushbu

$$\Phi(\Delta x, \Delta y) = f(x_0 + \Delta x, y_0 + \Delta y) - f(x_0 + \Delta x, y_0) - \\ - f(x_0, y_0 + \Delta y) + f(x_0, y_0), \\ \varphi(x) = f(x, y_0 + \Delta y) - f(x, y_0)$$

funksiyalarni qaraylik.

Ravshanki,

$$\Phi(\Delta x, \Delta y) = \varphi(x_0 + \Delta x) - \varphi(x_0)$$

bo'ladi. Bu tenglikning o'ng tomoniga Lagranj teoremasini ikki marta qo'llab topamiz:

$$\varphi(x_0 + \Delta x) - \varphi(x_0) = \varphi'(x_0 + \theta_1 \cdot \Delta x) \cdot \Delta x = \\ = \left[\frac{\partial f(x_0 + \theta_1 \Delta x, y_0 + \Delta y)}{\partial x} - \frac{\partial f(x_0 + \theta_1 \Delta x, y_0)}{\partial x} \right] \Delta x = \\ = \frac{\partial^2 f(x_0 + \theta_1 \Delta x, y_0 + \theta_2 \Delta y)}{\partial y \partial x} \cdot \Delta x \cdot \Delta y, \quad (0 < \theta_1, \theta_2 < 1).$$

Shartga ko'ra aralash hosila (x_0, y_0) nuqtada uzluksiz. Demak, $\Delta x \rightarrow 0, \Delta y \rightarrow 0$ da

$$\frac{\partial^2 f(x_0 + \theta_1 \Delta x, y_0 + \theta_2 \Delta y)}{\partial y \partial x} \Delta x \Delta y = \frac{\partial^2 f(x_0, y_0)}{\partial y \partial x} \Delta x \Delta y + o(1)$$

bo'lib,

$$\Phi(\Delta x, \Delta y) = \frac{\partial^2 f(x_0, y_0)}{\partial y \partial x} \Delta x \Delta y + o(1) \quad (7)$$

bo'ladi.

Endi $\Phi(\Delta x, \Delta y)$ funksiya bilan birga quyidagi

$$\psi(y) = f(x_0 + \Delta x, y) - f(x_0, y)$$

funksiyani qaraymiz. Ravshanki,

$$\Phi(\Delta x, \Delta y) = \psi(y_0 + \Delta y) - \psi(y_0)$$

bo'ladi. Yuqoridagidek, bu tenglikning o'ng tomoniga Lagranj teore-

masini ikki marta qo'llab, so'ng aralash hosilaning (x_0, y_0) nuqtada uzluksizligidan foydalanib topamiz:

$$\begin{aligned} \psi(y_0 + \Delta y) - \psi(y_0) &= \left[\frac{\partial f(x_0 + \Delta x, y_0 + \theta'_1 \Delta y)}{\partial y} - \frac{\partial f(x_0, y_0 + \theta'_1 \Delta y)}{\partial y} \right] \Delta y = \\ &= \frac{\partial^2 f(x_0 + \theta'_2 \Delta x, y_0 + \theta'_1 \Delta y)}{\partial x \partial y} \Delta x \Delta y = \frac{\partial^2 f(x_0, y_0)}{\partial x \partial y} \Delta x \Delta y + o(1), \\ &\quad (0 < \theta'_1, \theta'_2 < 1, \Delta x \rightarrow 0, \Delta y \rightarrow 0). \end{aligned}$$

Demak,
$$\Phi(\Delta x, \Delta y) = \frac{\partial^2 f(x_0, y_0)}{\partial x \partial y} \Delta x \Delta y + o(1). \quad (8)$$

(7) va (8) munosabatlardan

$$\frac{\partial^2 f(x_0, y_0)}{\partial x \partial y} = \frac{\partial^2 f(x_0, y_0)}{\partial y \partial x}$$

bo'lishi kelib chiqadi. ►

Mashqlar

1. Ushbu $u = f(x, y)$, $x = t^2 + s^2$, $y = t \cdot s$ funksiyaning ikkinchi tartibli differensial topilsin.

2. Ushbu $u = y \cdot \varphi(x^2 - y)$ funksiya quyidagi

$$\frac{1}{x} \frac{\partial u}{\partial x} + \frac{1}{y} \frac{\partial u}{\partial y} = \frac{u}{y^2}$$

tenglikni qanoatlantirishi isbotlansin.

63- ma'ruza

Ko'p o'zgaruvchili funksiyaning ekstremumlari

1°. **Funksiya ekstremumi tushunchasi. Zaruriy shart.** Faraz qilaylik, $f(x) = f(x_1, x_2, \dots, x_m)$ funksiya $E \subset R^m$ to'plamda berilgan bo'lib, $x^0 = (x_1^0, x_2^0, \dots, x_m^0) \in E$ bo'lsin.

1- ta'rif. Agar shunday $\delta > 0$ son topilsaki,

$$U_\delta(x^0) \subset E \text{ bo'lib, } \forall x \in U_\delta(x^0) \text{ da } f(x) \leq f(x^0)$$

bo'lsa, $f(x)$ funksiya x^0 nuqtada lokal maksimumga; $f(x) \geq f(x^0)$ bo'lsa, $f(x)$ funksiya x^0 nuqtada lokal minimumga erishadi deyiladi.

2- ta'rif. Agar shunday $\delta > 0$ son topilsaki, $U_\delta(x^0) \subset E$ bo'lib, $\forall x \in U_\delta(x^0) \setminus \{x^0\}$ da $f(x) < f(x^0)$ bo'lsa, $f(x)$ funksiya x^0 nuqtada qat'iy lokal maksimumga; $f(x) > f(x^0)$ bo'lsa, $f(x)$ funksiya x^0 nuqtada qat'iy lokal minimumga erishadi deyiladi.

Funksiyaning lokal maksimumi, lokal minimumi umumiy nom bilan funksiyaning *lokal ekstremumi* deyiladi. Bunda x^0 nuqta $f(x)$ funksiyaning *lokal ekstremum nuqtasi*, $f(x^0)$ ga esa funksiyaning *lokal ekstremum qiymati* deyiladi.

Funksiyaning maksimum (minimum) qiymati quyidagicha belgilanadi:

$$f(x^0) = \max_{x \in U_\delta(x^0)} f(x), \quad \left(f(x^0) = \max_{x \in U_\delta(x^0)} f(x) \right).$$

Ma'lumki, $\Delta f(x^0) = f(x) - f(x^0)$ ayirma funksiyaning x^0 nuqtadagi to'liq orttirmasi deyilar edi.

$f(x)$ funksiya x^0 nuqtada lokal maksimumga erishsa, u holda $\forall x \in U_\delta(x^0)$ da

$$\Delta f(x^0) \leq 0$$

bo'ladi va aksincha. Shuningdek, $f(x)$ funksiya x^0 nuqtada lokal minimumga erishsa, u holda $\forall x \in U_\delta(x^0)$ da

$$\Delta f(x^0) \geq 0$$

bo'ladi va aksincha.

1- teorema. Agar $f(x) = f(x_1, x_2, \dots, x_m)$ funksiya $x^0 = (x_1^0, x_2^0, \dots, x_m^0)$ nuqtada lokal ekstremumga erishsa va shu nuqtada barcha

$$\frac{\partial f}{\partial x_i}, \quad (i = 1, 2, \dots, m)$$

xususiyl hosilalarga ega bo'lsa, u holda

$$\frac{\partial f(x^0)}{\partial x_i} = 0, \quad (i = 1, 2, \dots, m)$$

bo'ladi.

◀ Aytaylik, $f(x) = f(x_1, x_2, \dots, x_m)$ funksiya $x^0 = (x_1^0, x_2^0, \dots, x_m^0)$ nuqtada lokal minimumga erishsin. U holda

$\forall x = (x_1, x_2, \dots, x_m) \in U_\delta(x^0)$ da $f(x_1, x_2, \dots, x_m) \geq f(x_1^0, x_2^0, \dots, x_m^0)$ tengsizlik bajariladi. Jumladan,

$$f(x_1, x_2^0, x_3^0, \dots, x_m^0) \geq f(x_1^0, x_2^0, \dots, x_m^0)$$

bo'ladi. Agar

$$\varphi(x_1) = f(x_1, x_2^0, x_3^0, \dots, x_m^0)$$

deyilsa, $\forall x_1 \in (x_1^0 - \delta, x_1^0 + \delta)$ da

$$\varphi(x_1) \geq \varphi(x_1^0)$$

bo'lib, bir o'zgaruvchili $\varphi(x_1)$ funksiya x_1^0 nuqtada lokal minimumga erishadi. U holda 25- ma'ruzada keltirilgan teoreмага ko'ra

$$\varphi'(x_1^0) = 0, \text{ ya'ni } \frac{\partial f(x^0)}{\partial x_1} = 0$$

bo'ladi. Xuddi shunga o'xshash

$$\frac{\partial f(x^0)}{\partial x_2} = 0, \dots, \frac{\partial f(x^0)}{\partial x_m} = 0$$

bo'lishi isbotlanadi. ▶

1- eslatma. Agar $f(x)$ funksiya biror x^0 nuqtada lokal ekstremumga erishsa va shu nuqtada differensiallanuvchi bo'lsa, u holda

$$df(x^0) = 0$$

bo'ladi.

2- eslatma. $f(x) = f(x_1, x_2, \dots, x_m)$ funksiyaning biror x^0 nuqtada barcha xususiy hosilalarga ega va

$$\frac{\partial f(x^0)}{\partial x_i} = 0, \quad (i = 1, 2, \dots, m)$$

bo'lishidan, berilgan funksiyaning shu nuqtada lokal ekstremumga erishishi har doim kelib chiqavermaydi (misollar keyingi badda keltiriladi).

Demak, 1- teorema funksiyaning lokal ekstremumga erishishining zaruriy shartini ifodalaydi.

$f(x)$ funksiya xususiy hosilalarini nolga aylantiradigan nuqtalar uning *statsionar nuqtalari* deyiladi.

2°. Funksiya ekstremumga erishishining yetarli sharti. Aytaylik, $f(x) = f(x_1, x_2, \dots, x_m)$ funksiya $x^0 \in R^m$ nuqtaning biror $U_\delta(x^0)$ atrofida berilgan, shu atrofda barcha ikkinchi tartibli uzluksiz xususiy hosilalarga ega va

$$\frac{\partial f(x^0)}{\partial x_i} = 0, \quad (i = 1, 2, \dots, m)$$

bo'lsin. Bu funksiyaning Teylor formulasi (62- ma'ruzada keltirilgan Teylor formulasida $n = 2$ bo'lgan hol)

$$\frac{\partial f(x^0)}{\partial x_i} = 0, \quad (i = 1, 2, \dots, m)$$

shartni hisobga olgan holda quyidagicha

$$f(x) = f(x^0) + \frac{1}{2} \sum_{i,k=1}^m \frac{\partial^2 f}{\partial x_i \partial x_k} \Delta x_i \Delta x_k \quad (1)$$

ko'rinishda ifodalanadi, bunda ikkinchi tartibli xususiy hosilalar

$$(x_1^0 + \theta \cdot \Delta x_1, x_2^0 + \theta \cdot \Delta x_2, \dots, x_m^0 + \theta \cdot \Delta x_m)$$

($0 < \theta < 1$) nuqtada hisoblangan va bunda

$$\Delta x_1 = x_1 - x_1^0, \quad \Delta x_2 = x_2 - x_2^0, \quad \dots, \quad \Delta x_m = x_m - x_m^0.$$

Berilgan $f(x)$ funksiya ikkinchi tartibli xususiy hosilalarining x^0 statsionar nuqtadagi qiymatlarini

$$a_{ik} = \frac{\partial^2 f(x^0)}{\partial x_i \partial x_k}, \quad (i, k = 1, 2, \dots, m)$$

bilan belgilaymiz. Barcha ikkinchi tartibli xususiy hosilalar

$$\frac{\partial^2 f}{\partial x_i \partial x_k}$$

larning $x^0 = (x_1^0, x_2^0, \dots, x_m^0)$ nuqtada uzluksizligidan

$$a_{ik} = a_{ki}$$

hamda

$$\frac{\partial^2 f(x_1^0 + \theta \Delta x_1, x_2^0 + \theta \Delta x_2, \dots, x_m^0 + \theta \Delta x_m)}{\partial x_i \partial x_k} = \frac{\partial^2 f(x^0)}{\partial x_i \partial x_k} + \alpha_{ik} = a_{ik} + \alpha_{ik}$$

bo'lishi kelib chiqadi, bunda

$$\Delta x_i \rightarrow 0, \quad (i = 1, 2, \dots, m) \quad \text{da} \quad \alpha_{ik} \rightarrow 0.$$

Natijada (1) tenglik ushbu

$$\Delta f(x^0) = f(x) - f(x^0) = \frac{1}{2} \left[\sum_{i,k=1}^m a_{ik} \Delta x_i \Delta x_k + \sum_{i,k} \alpha_{ik} \Delta x_i \Delta x_k \right]$$

ko'rinishga keladi. Agar

$$\rho = \sqrt{\Delta x_1^2 + \Delta x_2^2 + \dots + \Delta x_m^2},$$

$$\Delta x_i = \rho \cdot \zeta_i, \quad (i = 1, 2, \dots, m)$$

deyilsa, so'ngra $\Delta x_i \rightarrow 0$ ($i = 1, 2, \dots, m$) da, ya'ni $\rho \rightarrow 0$ da

$$\sum_{i,k=1}^m \alpha_{ik} \Delta x_k \Delta x_i = \rho^2 \sum_{i,k} \alpha_{ik} \zeta_i \zeta_k = \rho^2 \cdot \alpha(\rho)$$

(bunda, $\rho \rightarrow 0$ da $\alpha(\rho) \rightarrow 0$) bo'lishini e'tiborga olsak, u holda

$$\Delta f(x^0) = \frac{\rho^2}{2} \left[\sum_{i,k=1}^m a_{i,k} \zeta_i \zeta_k + \alpha(\rho) \right] \quad (2)$$

bo'lishini topamiz.

Ma'lumki, $\Delta f(x^0) = f(x) - f(x^0)$ ayirma $U_\delta(x^0)$ da ishora saqlasa, ya'ni $\forall x \in U_\delta(x^0)$ da

$$\Delta f(x^0) \geq 0$$

bo'lsa, $f(x)$ funksiya x^0 nuqtada lokal minimumga;

$$\Delta f(x^0) \leq 0$$

bo'lsa, $f(x)$ funksiya x^0 nuqtada lokal maksimumga erishadi.

Yuqoridagi (2) tenglikdan ko'rinadiki, $\Delta f(x^0)$ ning ishorasi koeffitsiyentlari

$$a_{ik} = \frac{\partial^2 f(x^0)}{\partial x_i \partial x_k}, \quad (i, k = 1, 2, \dots, m)$$

bo'lgan
$$\sum_{i,k=1}^m a_{ik} \zeta_i \zeta_k \quad (3)$$

kvadratik shaklga bog'liq bo'ladi.

2- teorema. Agar (3) kvadratik shakl musbat aniqlangan bo'lsa, $f(x)$ funksiya x^0 nuqtada lokal minimumga; manfiy aniqlangan bo'lsa, lokal maksimumga erishadi.

Agar (3) kvadratik shakl noaniq bo'lsa, $f(x)$ funksiya x^0 nuqtada lokal ekstremumga erishmaydi.

◀ Bu teorema, keyingi bandeda, xususiy holda, ya'ni ikki o'zgaruvchili funksiyalar uchun isbotlanadi. ▶ (Qaralsin, [1], 13- bob).

3°. Xususiy hollar. $m = 1$ bo'lsin. Bu holda $u = f(x)$, ($x \in R, u \in R$) funksiyaning lokal ekstremumlari, ekstremumning zaruriy va yetarli shartlari kabi tushuncha va tasdiqlarga kelamiz. Ular 25- ma'ruzada bayon etilgan.

$m = 2$ bo'lsin. Bu holda $u = f(x, y)$, ($(x, y) \in R^2, u \in R$) ikki o'zgaruvchili funksiyaning lokal ekstremum tushunchalari yuzaga kelib, bu hol uchun ularning ta'riflari quyidagicha bo'ladi.

Aytaylik, $u = f(x, y)$ funksiya $E \subset R^m$ to'plamda berilgan bo'lib, $(x_0, y_0) \in E$ bo'lsin.

Agar $\delta > 0$ shunday son topilsaki, $U_\delta((x^0, y^0)) \subset E$ bo'lib, $\forall (x, y) \in U_\delta((x_0, y_0))$ uchun

$$f(x, y) \geq f(x_0, y_0), \quad (f(x, y) \leq f(x_0, y_0))$$

bo'lsa, $f(x, y)$ funksiya (x_0, y_0) nuqtada lokal minimumga (lokal maksimumga) erishadi deyiladi. (x_0, y_0) nuqta $f(x, y)$ funksiyaning lokal minimum (maksimum) nuqtasi, $f(x_0, y_0)$ miqdor esa funksiyaning minimum (maksimum) qiymati deyiladi.

Agar shunday $\delta > 0$ son topilsaki, $U_\delta((x^0, y^0)) \subset E$ bo'lib, $\forall (x, y) \in U_\delta((x_0, y_0)) \setminus \{(x_0, y_0)\}$ uchun

$$f(x, y) > f(x_0, y_0), \quad (f(x, y) < f(x_0, y_0))$$

bo'lsa, $f(x, y)$ funksiya (x_0, y_0) nuqtada qat'iy lokal minimumga (qat'iy lokal maksimumga) erishadi deyiladi.

1- misol. Ushbu $f(x, y) = \sqrt{1 - x^2 - y^2}$ funksiyaning $(0, 0)$ nuqtada qat'iy maksimumga erishishi ko'rsatilsin.

◀ $\delta > 0$, ($0 < \delta < 1$) sonni olib, $(0,0)$ nuqtaning $U_\delta((0,0))$ atrofini hosil qilamiz. U holda $\forall (x,y) \in U_\delta((0,0)) \setminus \{(0,0)\}$ uchun

$$f(x,y) = \sqrt{1-x^2-y^2} < f(0,0) = 1$$

bo'ladi. Demak, berilgan funksiya $(0,0)$ nuqtada maksimumga erishadi. ▶

Agar $f(x,y)$ funksiya $(x_0,y_0) \in E \subset R^2, \delta > 0^m$ nuqtada lokal ekstremumga erishsa va shu nuqtada

$$\frac{\partial f}{\partial x}, \frac{\partial f}{\partial y}$$

xususiy hosilalarga ega bo'lsa, u holda

$$\frac{\partial f(x_0,y_0)}{\partial x} = 0, \quad \frac{\partial f(x_0,y_0)}{\partial y} = 0$$

bo'ladi.

Biroq, $f(x,y)$ funksiyaning biror (x^*,y^*) nuqtada $\frac{\partial f}{\partial x}, \frac{\partial f}{\partial y}$ xususiy hosilalari mavjud bo'lib, ular shu nuqtada nolga teng bo'lsa, qarayotgan funksiya (x^*,y^*) nuqtada ekstremumga erishmasdan qolishi mumkin. Masalan,

$$f(x,y) = xy$$

funksiya
$$\frac{\partial f}{\partial x} = y, \quad \frac{\partial f}{\partial y} = x$$

xususiy hosilalarga ega bo'lib, ular $(0,0)$ nuqtada nolga teng:

$$\frac{\partial f(0,0)}{\partial x} = 0, \quad \frac{\partial f(0,0)}{\partial y} = 0$$

bo'lsa ham, bu funksiya $(0,0)$ nuqtada ekstremumga erishmaydi (funksiya grafigi – giperbolik paraboloidni tasavvur qiling).

Aytaylik, $f(x,y)$ funksiya $(x_0,y_0) \in R^2$ nuqtaning biror $U_\delta((x_0,y_0))$ atrofida ($\delta > 0$) berilgan bo'lib, quyidagi shartlarni bajarsin:

1) $f(x,y)$ funksiya $U_\delta((x_0,y_0))$ da uzluksiz va uzluksiz $f'_x, f'_y, f''_{x^2}, f''_{xy}, f''_{y^2}$ xususiy hosilalarga ega,

2) (x_0, y_0) statsionar nuqta:

$$f'_x(x_0, y_0) = 0, \quad f'_y(x_0, y_0) = 0.$$

Bu $f(x)$ funksiya uchun 2° da yuritilgan mulohazalarni qo'llab

$$\Delta f(x_0, y_0) = f(x, y) - f(x_0, y_0) = \\ = \frac{1}{2}(a_{11}\Delta x^2 + 2a_{12}\Delta x\Delta y + a_{22}\Delta y^2 + \alpha_{11}\Delta x^2 + 2\alpha_{12}\Delta x\Delta y + \alpha_{22}\Delta y^2) \quad (*)$$

bo'lishini topamiz, bunda

$$a_{11} = f''_{xx}(x_0, y_0), \quad a_{12} = f''_{xy}(x_0, y_0) = f''_{yx}(x_0, y_0), \quad a_{22} = f''_{yy}(x_0, y_0)$$

bo'lib,

$$\Delta x \rightarrow 0, \quad \Delta y \rightarrow 0 \quad \text{da} \quad \alpha_{11} \rightarrow 0, \quad \alpha_{12} \rightarrow 0, \quad \alpha_{22} \rightarrow 0$$

bo'ladi.

3- teorema. Agar

$$a_{11}\Delta x^2 + 2a_{12}\Delta x\Delta y + a_{22}\Delta y^2 \quad (4)$$

kvadratik shakl musbat aniqlangan, ya'ni

$$a_{11} > 0, \quad \begin{vmatrix} a_{11} & a_{12} \\ a_{21} & a_{22} \end{vmatrix} = a_{11}a_{22} - a_{12}^2 > 0$$

bo'lsa, $f(x, y)$ funksiya (x_0, y_0) nuqtada lokal minimumga erishadi, agar (4) kvadratik shakl manfiy aniqlangan, ya'ni

$$a_{11} < 0, \quad \begin{vmatrix} a_{11} & a_{12} \\ a_{21} & a_{22} \end{vmatrix} = a_{11}a_{22} - a_{12}^2 > 0$$

bo'lsa, $f(x, y)$ funksiya (x_0, y_0) nuqtada lokal maksimumga erishadi.

◀ Ma'lumki, $f(x, y)$ funksiyaning (x_0, y_0) nuqtada ekstremumga erishishi $U_\delta((x_0, y_0))$ da ushbu

$$\Delta f(x_0, y_0) = f(x, y) - f(x_0, y_0)$$

ayirmaning ishora saqlashi bilan bog'liq:

$$\forall (x, y) \in U_\delta((x_0, y_0)) \quad \text{da} \quad \Delta f(x_0, y_0) > 0 \quad \text{bo'lsa,}$$

(x_0, y_0) nuqtada lokal minimum; $\Delta f(x_0, y_0) < 0$ bo'lsa, (x_0, y_0) nuqtada lokal maksimum sodir bo'ladi.

$\Delta f(x_0, y_0)$ ayirmaning ishorasini aniqlash qulay bo'lishi maqsadida (4) da

$$\Delta x = \rho \cdot \cos \varphi, \quad \Delta y = \rho \cdot \sin \varphi$$

almashtirish bajaramiz, bunda

$$\rho = \sqrt{\Delta x^2 + \Delta y^2}.$$

Natijada (*) munosabat ushbu

$$\Delta f(x_0, y_0) = \frac{\rho^2}{2} \left[(a_{11} \cos^2 \varphi + 2a_{12} \cos \varphi \sin \varphi + a_{22} \sin^2 \varphi) + (\alpha_{11} \cos^2 \varphi + 2\alpha_{12} \cos \varphi \sin \varphi + \alpha_{22} \sin^2 \varphi) \right] \quad (5)$$

ko'rinishga keladi. Aytaylik,

$$a_{11} > 0, \quad a_{11}a_{22} - a_{12}^2 > 0$$

bo'lsin. Ravshanki,

$$\begin{aligned} & a_{11} \cos^2 \varphi + 2a_{12} \cos \varphi \sin \varphi + a_{22} \sin^2 \varphi = \\ & = \frac{1}{a_{11}} \left[(a_{11} \cos \varphi + a_{12} \sin \varphi)^2 + (a_{11}a_{22} - a_{12}^2) \cdot \sin^2 \varphi \right]. \end{aligned}$$

Ayni paytda, bu funksiya φ ning funksiyasi sifatida $[0, 2\pi]$ da uzluksiz bo'lib, o'zining eng kichik qiymati (uni m bilan belgilaylik) m ga ega bo'ladi:

$$|a_{11} \cos^2 \varphi + 2a_{12} \cos \varphi \sin \varphi + a_{22} \sin^2 \varphi| \geq m > 0.$$

Ikkinchi tomondan, $\Delta x \rightarrow 0$, $\Delta y \rightarrow 0$, ya'ni $\rho \rightarrow 0$ da $\alpha_{11} \rightarrow 0$, $\alpha_{12} \rightarrow 0$, $\alpha_{22} \rightarrow 0$ bo'lganligi sababli, ρ ning yetarli kichik qiymatlarida

$|\alpha_{11} \cos^2 \varphi + 2\alpha_{12} \cos \varphi \sin \varphi + \alpha_{22} \sin^2 \varphi| \leq |\alpha_{11}| + 2|\alpha_{12}| + |\alpha_{22}| < m$ bo'loladi.

Demak, $a_{11} > 0$, $a_{11}a_{22} - a_{12}^2 > 0$ bo'lganda (5) tenglikning o'ng tomonidagi ifoda musbat bo'ladi. Binobarin,

$$\Delta f(x_0, y_0) > 0$$

bo'lib, $f(x, y)$ funksiya (x_0, y_0) nuqtada lokal minimumga erishadi.

$$\text{Aytaylik,} \quad a_{11} < 0, \quad a_{11}a_{22} - a_{12}^2 > 0$$

bo'lsin. Bu holda (5) tenglikning o'ng tomonidagi ifoda manfiy bo'ladi. Binobarin,

$$\Delta f(x_0, y_0) < 0$$

bo'lib, $f(x, y)$ funksiya (x_0, y_0) nuqtada lokal maksimumga erishadi. ►

3-eslatma. Agar $a_{11}a_{22} - a_{12}^2 < 0$ bo'lsa, $f(x,y)$ funksiya (x_0, y_0) nuqtada ekstremumga erishmaydi.

4-eslatma. Agar $a_{11}a_{22} - a_{12}^2 = 0$ bo'lsa, $f(x,y)$ funksiya (x_0, y_0) nuqtada ekstremumga erishishi ham mumkin, erishmasligi ham mumkin (qaralsin, [1], 13- bob).

2- misol. Ushbu

$$f(x, y) = x^2 + xy + y^2 - 2x - 3y$$

funksiya ekstremumga tekshirilsin.

◀ Avvalo berilgan funksiyaning statsionar nuqtalarini topamiz:

$$f'_x(x, y) = 2x + y - 2, \quad 2x + y - 2 = 0, \quad x_0 = \frac{1}{3},$$

$$f'_y(x, y) = x + 2y - 3, \quad x + 2y - 3 = 0, \quad y_0 = \frac{4}{3}.$$

Demak, $\left(\frac{1}{3}, \frac{4}{3}\right)$ – statsionar nuqta. Ravshanki,

$$f''_{x^2}(x, y) = 2, \quad f''_{xy}(x, y) = 1, \quad f''_{y^2}(x, y) = 2.$$

Demak, $a_{11} = 2$, $a_{12} = 1$, $a_{22} = 2$. Bunda $a_{11} = 2 > 0$ va $a_{11}a_{22} - a_{12}^2 = 3 > 0$ bo'lganligi uchun berilgan funksiya $\left(\frac{1}{3}, \frac{4}{3}\right)$ nuqtada lokal minimumga erishadi va

$$\min f(x, y) = f\left(\frac{1}{3}, \frac{4}{3}\right) = -\frac{7}{3}$$

bo'ladi. ▶

3- misol. Ushbu

$$f_1(x, y) = x^4 + y^4,$$

$$f_2(x, y) = -(x^4 + y^4),$$

$$f_3(x, y) = x^3 + y^3$$

funksiyalar ekstremumga tekshirilsin.

◀ Berilgan funksiyalar uchun $(0,0)$ statsionar nuqta bo'ladi. Bu funksiyalar uchun

$$a_{11}a_{22} - a_{12}^2 = 0$$

bo'ladi. Ravshanki, $(0,0)$ nuqtada $f_1(x,y)$ funksiya minimumga, $f_2(x,y)$ funksiya esa maksimumga erishadi. $f_3(x,y)$ funksiya $(0,0)$ nuqtada ekstremumga ega bo'lmaydi. ►

Mashqlar

1. 3- teoremda keltirilgan $f(x,y)$ funksiya uchun (x_0,y_0) stasionar nuqtada

$$f''_{x^2}(x_0, y_0) \cdot f''_{y^2}(x_0, y_0) - [f''_{xy}(x_0, y_0)]^2 < 0$$

bo'lsa, $f(x,y)$ funksiya (x_0,y_0) nuqtada ekstremumga erishmasligi isbotlansin.

2. Ushbu $f(x,y) = (y-x)^2 + (y+2)^3$ funksiya ekstremumga tekshirilsin.

64- ma'ruza

Oshkormas funksiyalar

1°. **Oshkormas funksiya tushunchasi.** Ma'lumki, $x \in R$, $Y \subset R$ to'plamlar va biror f qoida berilgan holda har bir $x \in X$ songa f qoidaga ko'ra bitta $y \in Y$ son mos qo'yilsa, X to'plamda $y = f(x)$ funksiya aniqlangan deyilar edi.

x va y o'zgaruvchilarni bog'lovchi qoida turlicha, jumladan, analitik ifodalar yordamida, jadval yordamida, egri chiziq yordamida bo'lishi mumkin.

Endi x va y o'zgaruvchilar tenglama yordamida bog'langan holda funksiya yuzaga kelishini ko'rsatamiz.

Aytaylik, x va y o'zgaruvchilarning $F(x, y)$ funksiyasi

$$E = \{(x, y) \in R^2 : a < x < b, c < y < d\}$$

to'plamda berilgan bo'lsin. Ushbu

$$F(x, y) = 0 \tag{1}$$

teglamani qaraylik. Har bir tayinlangan $x = x_0$ da (1) tenglama y ga nisbatan tenglamaga aylanadi. Bu tenglama yagona y_0 yechimga ega bo'lsin. Demak,

$$F(x_0, y_0) = 0.$$

Bunday xususiyatga ega bo'lgan x_0 nuqtalar bir qancha bo'lishi mumkin. Ulardan tashkil topgan to'plamni X deylik. Ravshanki, bunda $X \subset (a, b)$ bo'ladi.

Endi X to'plamdan olingan har bir x ga ($x \in X$) (1) tenglamaning yagona yechimi y ni mos qo'yaylik. Natijada X da aniqlangan funksiya hosil bo'ladi. Uni $\varphi(x)$ deylik. Demak,

$$\varphi : x \rightarrow y \text{ va } F(x, \varphi(x)) \equiv 0.$$

Bu $\varphi(x)$ oshkormas (oshkormas ko'rinishda berilgan) funksiya deyiladi.

1- misol. Ushbu

$$F(x, y) = y\sqrt{x^2 - 1} - 2 = 0 \quad (2)$$

tenglama yordamida oshkormas fuksiya aniqlanishi ko'rsatilsin.

◀ Ravshanki, (2) tenglama har bir $x \in (-\infty, -1) \cup (1, +\infty)$ da yagona

$$y = \varphi(x) = \frac{2}{\sqrt{x^2 - 1}}$$

yechimga ega va

$$F(x, \varphi(x)) \equiv 0.$$

Demak, (2) tenglama oshkormas funksiyani aniqlaydi. ▶

2- misol. Ushbu

$$F(x, y) = x - y + \frac{1}{2} \sin y = 0$$

tenglama yordamida oshkormas funksiya aniqlanishi ko'rsatilsin.

◀ Berilgan tenglamani quyidagicha yozib olamiz:

$$x = y - \frac{1}{2} \sin y = \alpha(y), \quad (y \in (-\infty, +\infty)).$$

Bu $\alpha(y)$ funksiya R da uzuluksiz va $\alpha'(y) = 1 - \frac{1}{2} \cos y > 0$ bo'ladi.

U holda $\alpha(y)$ funksiya $(-\infty, +\infty)$ da teskari $y = \alpha^{-1}(x)$ funksiyaga ega va

$$F(x, \alpha^{-1}(x)) = 0$$

bo'ladi. Demak, bu tenglama ushbu

$$\varphi : x \rightarrow \alpha^{-1}(x)$$

oshkormas funksiyani aniqlaydi. ▶

3- misol. Ushbu

$$F(x, y) = x^2 + y^2 - \ln y = 0, \quad (y > 0)$$

tenglama y ni x ning oshkormas funksiyasi sifatida aniqlaydimi?

◀ Aniqlamaydi, chunki har bir $x \in (-\infty, +\infty)$ da $y^2 - \ln y > 0$ bo'lganligi sababli, yechimga ega emas. ▶

Oshkormas funksiyalarni o'rganishda quyidagi masalalar muhimdir:

1) $F(x, y)$ funksiya biror $E \subset R^2$ to'plamda berilgan holda $y = \varphi(x)$ oshkormas funksiya mavjud bo'ladimi va bu funksiyaning aniqlanish to'plami qanday bo'ladi?

2) (1) tenglama bilan aniqlangan $y = \varphi(x)$ oshkormas funksiya qanday xossalarga ega va bu xossalar $F(x, y)$ funksiya xossalari bilan qanday bog'langan?

2°. Oshkormas funksiyaning mavjudligi.

1- teorema. Faraz qilaylik, $F(x, y)$ funksiya (x_0, y_0) nuqtaning biror atrofi

$$U_{hk}((x_0, y_0)) = \{(x, y) \in R^2 : x_0 - h < x < x_0 + h, y_0 - k < y < y_0 + k\}$$

da ($h > 0, k > 0$) berilgan bo'lib, quyidagi shartlarni bajarsin:

1) $F(x, y)$ funksiya $U_{hk}((x_0, y_0))$ da uzluksiz;

2) Har bir tayin $x \in (x_0 - h, x_0 + h)$ da y o'zgaruvchining funksiyasi sifatida o'suvchi;

3) $F(x_0, y_0) = 0$.

U holda (x_0, y_0) nuqtaning shunday atrofi

$$U_{\delta\epsilon}((x_0, y_0)) = \{(x, y) \in R^2 : x_0 - \delta < x < x_0 + \delta, y_0 - \epsilon < y < y_0 + \epsilon\}$$

topiladiki ($0 < \delta < h, 0 < \epsilon < k$), bunda:

a) $\forall x \in (x_0 - \delta, x_0 + \delta)$ da

$$F(x, y) = 0$$

tenglama yagona $y (y \in (y_0 - \epsilon, y_0 + \epsilon))$ yechimga ega, ya'ni $F(x, y) = 0$ tenglama yordamida $y = \varphi(x)$ oshkormas funksiya aniqlanadi;

b) $\varphi(x_0) = y_0$ bo'ladi;

d) $y = \varphi(x)$ funksiya $(x_0 - \delta, x_0 + \delta)$ da uzluksiz bo'ladi.

◀ $U_{hk}((x_0, y_0))$ atrofga tegishli bo'lgan

$$(x_0, y_0 - \varepsilon), (x_0, y_0 + \varepsilon), \quad (0 < \varepsilon < k)$$

nuqtalarni olib, $[y_0 - \varepsilon, y_0 + \varepsilon]$ segmentda

$$\psi(y) = F(x_0, y)$$

funksiyani qaraymiz. Teoremaning 2- shartiga ko'ra $\psi(y)$ o'suvchi, 3- shartiga ko'ra $\psi(y_0) = F(x_0, y_0) = 0$ bo'ladi. Bunda esa

$$\psi(y_0 - \varepsilon) = F(x_0, y_0 - \varepsilon) < 0,$$

$$\psi(y_0 + \varepsilon) = F(x_0, y_0 + \varepsilon) > 0$$

bo'lishi kelib chiqadi.

Teoremaning 1- shartiga ko'ra $F(x, y)$ funksiya $U_{hk}((x_0, y_0))$ da uzluksiz. U holda uzluksiz funksiyaning xossasiga ko'ra, x_0 nuqtaning shunday $(x_0 - \delta, x_0 + \delta)$ atrofi ($0 < \delta < h$) topiladiki, $\forall x \in (x_0 - \delta, x_0 + \delta)$ da

$$\begin{aligned} F(x, y_0 - \varepsilon) &< 0, \\ F(x, y_0 + \varepsilon) &> 0 \end{aligned} \quad (3)$$

bo'ladi. Endi (x_0, y_0) nuqtaning

$U_{\delta\varepsilon}((x_0, y_0)) = \{(x, y) \in R^2 : x_0 - \delta < x < x_0 + \delta, y_0 - \varepsilon < y < y_0 + \varepsilon\}$ atrofida

$$F(x, y) = 0$$

tenglama y ni x ning oshkormas funksiyasi sifatida aniqlashini ko'rsatamiz.

Ixtiyoriy $x^* \in (x_0 - \delta, x_0 + \delta)$ nuqtani olib, $[y_0 - \varepsilon, y_0 + \varepsilon]$ da ushbu

$$g(y) = F(x^*, y)$$

funksiyani qaraymiz. Ravshanki, bu funksiya $[y_0 - \varepsilon, y_0 + \varepsilon]$ segmentda uzluksiz va ayni paytda (3) munosabatga binoan

$$g(y_0 - \varepsilon) = F(x^*, y_0 - \varepsilon) < 0,$$

$$g(y_0 + \varepsilon) = F(x^*, y_0 + \varepsilon) > 0$$

bo'ladi. U holda Bolsano–Koshi teoremasiga ko'ra shunday $y^* \in [y_0 - \varepsilon, y_0 + \varepsilon]$ nuqta topiladiki, bunda

$$g(y^*) = F(x^*, y^*) = 0$$

bo'ladi.

Ayni paytda, $g(y)$ funksiya $[y_0 - \varepsilon, y_0 + \varepsilon]$ da o'suvchi (qat'iy o'suvchi) bo'lganligi sababli, y shu oraliqda bittadan ortiq nuqtada nolga aylanmaydi.

Shunday qilib, ixtiyoriy $x \in (x_0 - \delta, x_0 + \delta)$ uchun yagona $y \in (y_0 - \varepsilon, y_0 + \varepsilon)$ topiladiki, bunda

$$F(x, y) = 0$$

bo'ladi. Bu esa $U_{\delta\varepsilon}((x_0, y_0))$ da $F(x, y) = 0$ tenglama y ni x ning oshkormas funksiyasi sifatida aniqlashini bildiradi:

$$y = \varphi(x) : F(x, \varphi(x)) = 0.$$

Aytaylik, $x = x_0$ bo'lsin. U holda teoremaning 3- shartiga ko'ra

$$F(x_0, y_0) = 0$$

bo'ladi. Binobarin, aniqlangan oshkormas funksiyaning x_0 nuqtadagi qiymati $\varphi(x_0) = y_0$ bo'ladi.

Modomiki, $\forall x \in (x_0 - \delta, x_0 + \delta)$ uchun $\varphi(x)$ ga ko'ra unga mos keladigan $y \in (y_0 - \varepsilon, y_0 + \varepsilon)$ bo'lar ekan, u holda

$$|x - x_0| < \delta \Rightarrow |y - y_0| = |\varphi(x) - \varphi(x_0)| < \varepsilon$$

bo'ladi. Demak, oshkormas funksiya x_0 nuqtada uzluksiz.

Oshkormas funksiyaning $\forall x^* \in (x_0 - \delta, x_0 + \delta)$ nuqtada uzluksiz bo'lishini ko'rsatish bu funksiyaning x_0 nuqtada uzluksiz bo'lishini ko'rsatish kabidir. Demak, mavjudligi ko'rsatilgan oshkormas funksiya $(x_0 - \delta, x_0 + \delta)$ da uzluksiz bo'ladi. ►

3°. Oshkormas funksiyaning hosilalari. Oshkormas funksiyaning hosilasini aniqlaydigan teoremani keltiramiz.

2- teorema. Faraz qilaylik, $F(x, y)$ funksiya (x_0, y_0) nuqtaning biror atrofi $U_{hk}((x_0, y_0))$ da ($h > 0, k > 0$) berilgan bo'lib, quyidagi shartlarni bajarsin:

- 1) $U_{hk}((x_0, y_0))$ da uzluksiz;
- 2) $U_{hk}((x_0, y_0))$ da uzluksiz $F'_x(x, y), F'_y(x, y)$ xususiy hosilalarga ega va $F'_y(x_0, y_0) \neq 0$;
- 3) $F(x_0, y_0) = 0$.

U holda (x_0, y_0) nuqtaning shunday $U_{\delta\varepsilon}((x_0, y_0))$ atrofi ($0 < \delta < h, 0 < \varepsilon < k$) topiladiki, $F(x, y) = 0$ tenglama y ni x ning $y = \varphi(x)$ oshkormas funksiyasi sifatida aniqlaydi va bu $y = \varphi(x)$ funksiya $(x_0 - \delta, x_0 + \delta)$ da uzluksiz differensiallanuvchi bo'lib,

$$\varphi'(x) = -\frac{F'_x(x, \varphi(x))}{F'_y(x, \varphi(x))}$$

bo'ladi.

◀ Teoremaning shartiga ko'ra $F'_y(x, y)$ funksiya $U_{hk}((x_0, y_0))$ da uzluksiz va $F'_y(x_0, y_0) \neq 0$. Aytaylik, $F'_y(x_0, y_0) > 0$ bo'lsin. Uzluksiz funksiya xossasiga ko'ra (x_0, y_0) nuqtaning shunday $U_{\delta\varepsilon}((x_0, y_0))$ atrofi ($0 < \delta < h, 0 < \varepsilon < k$) topiladiki, $\forall (x, y) \in U_{\delta\varepsilon}((x_0, y_0))$ da $F'_y(x, y) > 0$ bo'ladi. Bundan esa har bir tayin $x \in (x_0 - \delta, x_0 + \delta)$ da $F(x, y)$ funksiya y o'zgaruvchining funksiyasi sifatida o'suvchi bo'lishi kelib chiqadi. U holda 1- teoremaga ko'ra $F(x, y) = 0$ tenglama $(x_0 - \delta, x_0 + \delta)$ da y ni x ning $y = \varphi(x)$ oshkormas funksiyasi sifatida aniqlaydi va $y = \varphi(x)$ oshkormas funksiya $x \in (x_0 - \delta, x_0 + \delta)$ da uzluksiz bo'lib, $\varphi(x_0) = y_0$ bo'ladi.

Aytaylik, $x \in (x_0 - \delta, x_0 + \delta)$, $x + \Delta x \in (x_0 - \delta, x_0 + \delta)$ bo'lsin. Ravshanki,

$$F(x, y) = 0, \quad F(x + \Delta x, y + \Delta y) = 0$$

bo'lib, bundan quyidagi ifodani hosil qilamiz:

$$\Delta F(x, y) = F(x + \Delta x, y + \Delta y) - F(x, y) = 0. \quad (4)$$

Teoremaning shartidan $F(x, y)$ funksiyaning (x, y) nuqtada differensiallanuvchi bo'lishi kelib chiqadi. Binobarin,

$$\Delta F(x, y) = F'_x(x, y)\Delta x + F'_y(x, y)\Delta y + \alpha \cdot \Delta x + \beta \cdot \Delta y \quad (5)$$

bo'lib, $\Delta x \rightarrow 0, \Delta y \rightarrow 0$ da $\alpha \rightarrow 0, \beta \rightarrow 0$ bo'ladi.

(4) va (5) munosabatlardan topamiz:

$$\frac{\Delta y}{\Delta x} = -\frac{F'_x(x, y) + \alpha}{F'_y(x, y) + \beta}.$$

Keyingi tenglikda $\Delta x \rightarrow 0$ da limitga o'tsak, u holda

$$\varphi'(x) = y' = -\frac{F'_x(x,y)}{F'_y(x,y)}$$

hosil bo'ladi. $U_{\delta\epsilon}((x_0, y_0))$ da $F'_x(x, y)$, $F'_y(x, y)$ xususiy hosilalar uzluksiz va $F'_y(x, y) \neq 0$ bo'lishidan oshkormas funksiyaning hosilasi

$$\varphi'(x) = -\frac{F'_x(x,y)}{F'_y(x,y)}$$

ning $(x_0 - \delta, x_0 + \delta)$ da uzluksiz bo'lishi kelib chiqadi. ►

4- misol. Ushbu

$$F(x, y) = e^y + y \sin x - x^3 + 7 = 0$$

tenglama (2, 0) nuqtaning atrofida y ni x ning oshkormas funksiyasi sifatida aniqlashi va bu oshkormas funksiyaning hosilasi topilsin.

◀ Ravshanki,

$$F(x, y) = e^y + y \sin x - x^3 + 7$$

funksiya R^2 da aniqlangan va uzluksiz. Binobarin, u (2, 0) nuqtaning atrofida uzluksiz, $F(x, y)$ funksiyaning xususiy hosilalari quyidagicha bo'ladi:

$$\frac{\partial F(x, y)}{\partial x} = \frac{\partial}{\partial x} (e^y + y \sin x - x^3 + 7) = y \cos x - 3x^2,$$

$$\frac{\partial F(x, y)}{\partial y} = \frac{\partial}{\partial y} (e^y + y \sin x - x^3 + 7) = e^y + \sin x.$$

Demak, $F(x, y)$ funksiyaning xususiy hosilalari R^2 da, jumladan, (2, 0) nuqtaning atrofida uzluksiz.

So'ngra

$$\frac{\partial F(2, 0)}{\partial y} = (e^y + \sin x)_{x=2, y=0} = 1 + \sin 2 \neq 0.$$

Va nihoyat,

$$F(2, 0) = (e^y + y \sin x - x^3 + 7)_{x=2, y=0} = 0$$

bo'ladi. U holda 2- teoremaga ko'ra

$$F(x, y) = e^y + y \sin x - x^3 + 7 = 0$$

tenglama (2, 0) nuqtaning atrofida y ni x ning oshkormas funksiyasi

sifatida aniqlaydi va bu oshkormas $\varphi(x)$ funksiyaning hosilasi quyidagicha bo'ladi:

$$\varphi'(x) = -\frac{F'_x(x,y)}{F'_y(x,y)} = -\frac{y \cos x - 3x^2}{e^y + \sin x}. \quad \blacktriangleright$$

1- e s l a t m a. Oshkormas funksiyaning hosilasini quyidagicha ham hisoblasa bo'ladi:

$$F(x, y) = 0$$

ni (y o'zgaruvchi x ning funksiyasi ekanini hisobga olib) differensiallab topamiz:

$$F'_x(x, y) + F'_y(x, y) \cdot y' = 0.$$

Keyingi tenglikdan esa quyidagi ifoda kelib chiqadi:

$$y' = -\frac{F'_x(x,y)}{F'_y(x,y)}.$$

Aytaylik, $F(x,y)$ funksiya $U_{\delta\epsilon}((x_0, y_0))$ da uzluksiz ikkinchi tartibli

$$F''_{x^2}(x, y), F''_{xy}(x, y), F''_{y^2}(x, y)$$

xususiy hosilalarga ega bo'lsin. Ma'lumki,

$$y' = -\frac{F'_x(x,y)}{F'_y(x,y)}.$$

Buni differensiallab topamiz:

$$y'' = -\frac{(F'_x(x,y))'_x \cdot F'_y(x,y) - (F'_y(x,y))'_x \cdot F'_x(x,y)}{(F'_y(x,y))^2}.$$

Agar $(F'_x(x,y))'_x = F''_{x^2}(x,y) + F''_{xy}(x,y) \cdot y',$ (6)

$$(F'_y(x,y))'_x = F''_{yx}(x,y) + F''_{y^2}(x,y) \cdot y'$$

ekanini hisobga olsak. U holda

$$y'' = \frac{(F''_{yx}(x,y) + F''_{y^2}(x,y) \cdot y') F'_x(x,y) - (F''_{x^2}(x,y) + F''_{xy}(x,y) \cdot y') F'_y(x,y)}{(F'_y(x,y))^2} =$$

$$= \frac{F''_{yx}(x,y) F'_x(x,y) - F''_{xy}(x,y) F'_y(x,y) + [F''_{y^2}(x,y) F'_x(x,y) - F''_{xy}(x,y) F'_x(x,y)] y}{(F'_y(x,y))^2}$$

bo'ladi. Bu ifodadagi y' ning o'rniga

$$-\frac{F'_x(x,y)}{F'_y(x,y)}$$

ni qo'yib, oshkormas funksiyaning ikkinchi tartibli hosilasi uchun quyidagi formulaga kelamiz:

$$y'' = \frac{2F'_x \cdot F'_y \cdot F''_{xy} - F_y'^2 \cdot F_x'' - F_x'^2 \cdot F_y''}{F_y'^2}$$

2- e s l a t m a . Oshkormas funksiyaning yuqori tartibli hosillarini quyidagicha ham hisoblasa bo'ladi. Yuqorida

$$F(x, y) = 0$$

ni differensiallab,

$$F'_x(x, y) + F'_y(x, y) \cdot y' = 0$$

bo'lishini topgan edik. Buni yana bir marta differensiallab topamiz:

$$\begin{aligned} & [F'_x(x, y) + F'_y(x, y) \cdot y']'_x = \\ & = (F'_x(x, y))'_x + y' \cdot (F'_y(x, y))'_x + F'_y(x, y) \cdot y'' = 0. \end{aligned}$$

Agar (6) munsabatlardan foydalansak, keyingi tenglik ushbu

$$F''_{x^2}(x, y) + 2F''_{xy}(x, y) \cdot y' + F''_{y^2}(x, y) \cdot y'^2 + F'_y(x, y) \cdot y'' = 0$$

tenglikka keladi. Undan esa

$$y'' = -\frac{F''_{x^2}(x,y) + 2F''_{xy}(x,y) y' + F''_{y^2}(x,y) y'^2}{F'_y(x,y)}$$

bo'lishi kelib chiqadi.

5- misol. Ushbu

$$F(x, y) = xe^y + ye^x - 2 = 0$$

tenglama bilan aniqlanadigan oshkormas funksiyaning ikkinchi tartibli hosilasi topilsin.

◀ Differensiallab topamiz:

$$(F(x, y))'_x = (xe^y + ye^x - 2)'_x = 0,$$

$$e^y + ye^x + (xe^y + e^x) \cdot y' = 0, \quad (7)$$

$$y' = -\frac{e^y + ye^x}{e^x + xe^y}. \quad (8)$$

Endi (7) ni yana bir marta differensiallaymiz:

$$e^y \cdot y' + y'e^x + ye^x + e^y \cdot y' + xe^y y' \cdot y' + xe^y \cdot y'' + y''e^x + y'e^x = 0.$$

Keyingi tenglikdan

$$y'' = -\frac{2e^y y' + 2e^x y' + xe^y \cdot y'^2 + ye^x}{xe^y + e^x}$$

bo'lishi kelib chiqadi. Bu tenglikda y' ning o'rniga (8) da ifodalangan qiymatini qo'yib, oshkormas funksiyaning ikkinchi tartibli hosilasi topiladi. ►

Mashqlar

1. Ushbu $y^5 + y - x = 0$
tenglama bilan aniqlangan oshkormas funksiyaning grafigi yasalsin.

2. Ushbu $x^y = y^x, (x \neq y)$
tenglama bilan aniqlanadigan $y = \varphi(x)$ oshkormas funksiyaning y' va y'' hosilalari topilsin.

65- ma'ruza

Funksional ketma-ketliklar va ularning tekis yaqinlashuvchanligi

1°. Funksional ketma-ketlik va limit funksiya tushunchalari. Aytaylik, har bir natural n songa $E \subset R$ to'plamda aniqlangan bitta $f_n(x)$ funksiyani mos qo'yuvchi qoida berilgan bo'lsin. Bu qoidaga ko'ra

$$f_1(x), f_2(x), \dots, f_n(x), \dots \quad (1)$$

to'plam hosil bo'ladi. Uni *funksional ketma-ketlik* deyiladi. E to'plam (1) *funksional ketma-ketlikning aniqlanish to'plami* deyiladi.

Odatda, (1) funksional ketma-ketlik, uning n - hadi yordamida $\{f_n(x)\}$ yoki $f_n(x)$ kabi belgilanadi. Masalan,

$$f_n(x) = \frac{n+1}{n+x^2} : \frac{2}{1+x^2}, \frac{3}{2+x^2}, \dots, \frac{n+1}{n+x^2}, \dots;$$

$$f_n(x) = \sin \frac{\sqrt{x}}{n} : \sin \frac{\sqrt{x}}{1}, \sin \frac{\sqrt{x}}{2}, \dots, \sin \frac{\sqrt{x}}{n}, \dots$$

lar funksional ketma-ketliklar bo'ladi va ularning aniqlanish to'plami mos ravishda

$$E = R, E = [0, +\infty)$$

bo'ladi. Ravshanki, x o'zgaruvchining biror tayinlangan $x = x_0 \in E$ qiymatida ushbu

$$\{f_n(x_0)\} : f_1(x_0), f_2(x_0), \dots, f_n(x_0), \dots$$

sonlar ketma-ketligiga ega bo'lamiz.

1- ta'rif. Agar $\{f_n(x_0)\}$ sonli ketma-ketlik yaqinlashuvchi (uzoqlashuvchi) bo'lsa, $\{f_n(x)\}$ funksional ketma-ketlik $x = x_0$ nuqtada yaqinlashuvchi (uzoqlashuvchi) deyiladi. x_0 nuqta esa bu funksional ketma-ketlikning *yaqinlashish (uzoqlashish) nuqtasi* deyiladi.

2- ta'rif. $\{f_n(x)\}$ funksional ketma-ketlikning barcha yaqinlashish nuqtalaridan iborat $E_0 \subset E$ to'plam $\{f_n(x)\}$ funksional ketma-ketlikning *yaqinlashish to'plami* deyiladi.

Masalan, ushbu

$$f_n(x) = x^n : x, x^2, x^3, \dots, x^n, \dots$$

funksional ketma-ketlik aniqlanish to'plami $E = R$ bo'lib, u $\forall x \in (-1, 1]$ nuqtada yaqinlashuvchi, $x \in R \setminus (-1, 1]$ da uzoqlashuvchi bo'ladi. Demak, ketma-ketlikning yaqinlashish to'plami $E_0 = (-1, 1]$ bo'ladi.

Faraz qilaylik, $\{f_n(x_0)\}$ funksional ketma-ketlikning yaqinlashish to'plami $E_0 (E_0 \in R)$ bo'lsin. Ravshanki, bu holda har bir $x \in E_0$ da

$$f_1(x), f_2(x), \dots, f_n(x), \dots$$

ketma-ketlik yaqinlashuvchi, ya'ni

$$\lim_{n \rightarrow \infty} f_n(x)$$

mavjud bo'ladi. Endi har bir $x \in E$ ga $\lim_{n \rightarrow \infty} f_n(x)$ ni mos qo'ysak, ushbu

$$f : x \rightarrow \lim_{n \rightarrow \infty} f_n(x)$$

funksiya hosil bo'ladi. Bu $f(x)$ funksiya $\{f_n(x_0)\}$ funksional ketma-ketlikning limit funksiyasi deyiladi:

$$\lim_{n \rightarrow \infty} f_n(x) = f(x), \quad (x \in E_0).$$

Bu munosabat quyidagini anglatadi: ixtiyoriy $\varepsilon > 0$ son va har bir $x \in E_0$ uchun shunday natural $n_0 = n_0(\varepsilon, x)$ son topiladiki, ixtiyoriy $n > n_0$ da

$$|f_n(x) - f(x)| < \varepsilon,$$

ya'ni

$\forall \varepsilon > 0, \exists n_0 = n_0(\varepsilon, x) \in N, \forall n > n_0 : |f_n(x) - f(x)| < \varepsilon$ bo'ladi.

1- misol. Ushbu $f_n(x) = n \sin \frac{\sqrt{x}}{n}$

funksional ketma-ketlikning limit funksiyasi topilsin.

◀ Berilgan funksional ketma-ketlik $E = [0, +\infty)$ da aniqlangan. Uning limit funksiyasi

$$f(x) = \lim_{n \rightarrow \infty} f_n(x) = \lim_{n \rightarrow \infty} n \sin \frac{\sqrt{x}}{n} = \lim_{n \rightarrow \infty} \frac{\sin \frac{\sqrt{x}}{n}}{\frac{\sqrt{x}}{n}} \cdot \sqrt{x} = \sqrt{x}$$

bo'ldi. Demak, funksional ketma-ketlik $E = [0, +\infty)$ da yaqinlashuvchi va

$$\lim_{n \rightarrow \infty} n \sin \frac{\sqrt{x}}{n} = \sqrt{x}. \blacktriangleright$$

2- misol. Ushbu $f_n(x) = x^n$

funksional ketma-ketlikning limit funksiyasi topilsin.

◀ Bu funksional ketma-ketlik $E = R$ da aniqlangan. Ravshanki,

$$\forall x \in (1, +\infty) \text{ da } \lim_{n \rightarrow \infty} f_n(x) = \lim_{n \rightarrow \infty} x^n = +\infty,$$

$$\forall x \in (-1, 1) \text{ da } \lim_{n \rightarrow \infty} f_n(x) = \lim_{n \rightarrow \infty} x^n = 0,$$

$$x = 1 \text{ da } \lim_{n \rightarrow \infty} f_n(x) = \lim_{n \rightarrow \infty} 1 = 1,$$

$$\forall x \in (-\infty, -1) \text{ da } \lim_{n \rightarrow \infty} f_n(x) \text{ mavjud emas.}$$

Demak, berilgan funksional ketma-ketlik $E_0 = (-1, 1]$ da yaqinlashuvchi bo'lib, uning limit funksiyasi

$$f(x) = \lim_{n \rightarrow \infty} x^n = \begin{cases} 0, & \text{agar } -1 < x < 1 \text{ bo'lsa,} \\ 1, & \text{agar } x = 1 \text{ bo'lsa} \end{cases}$$

bo'ldi. ▶

3- misol. Ushbu

$$f_n(x) = n^2 (\sqrt[n]{x} - \sqrt[n+1]{x}), \quad (x > 0)$$

funksional ketma-ketlikning limit funksiyasi topilsin.

◀ Berilgan funksional ketma-ketlikning limit funksiyasi quyidagicha topiladi:

$$\begin{aligned} f(x) &= \lim_{n \rightarrow \infty} (f_n(x)) = \lim_{n \rightarrow \infty} n^2 (\sqrt[n]{x} - \sqrt[n+1]{x}) = \lim_{n \rightarrow \infty} n^2 \left(x^{\frac{1}{n}} - x^{\frac{1}{n+1}} \right) = \\ &= \lim_{n \rightarrow \infty} n^2 x^{\frac{1}{n+1}} \left(x^{\frac{1}{n} - \frac{1}{n+1}} - 1 \right) = \lim_{n \rightarrow \infty} \frac{n^2}{n^2 + n} x^{\frac{1}{n+1}} \cdot \frac{x^{\frac{1}{n^2+n}} - 1}{\frac{1}{n^2+n}} = \ln x. \blacktriangleright \end{aligned}$$

2°. Funktsional ketma-ketlikning tekis yaqinlashuvchanligi. Faraz qilaylik, $\{f_n(x_0)\}$:

$$f_1(x), f_2(x), \dots, f_n(x), \dots$$

funksional ketma-ketlik E_0 to'plamda yaqinlashuvchi (ya'ni yaqinlashish to'plami E_0) bo'lib, uning limit funksiyasi $f(x)$ bo'lsin:

$$\lim_{n \rightarrow \infty} f_n(x) = f(x).$$

Ma'lumki, bu munosabat

$$\forall \varepsilon > 0, \exists n_0 = n_0(\varepsilon, x) \in N, \forall n > n_0 : |f_n(x) - f(x)| < \varepsilon$$

bo'lishini anglatadi. Shuni ta'kidlash lozimki, yuqoridagi natural n_0 son ixtiyoriy olingan $\varepsilon > 0$ son bilan birga qaralayotgan $x \in E_0$ nuqtaga ham bog'liq bo'ladi (chunki, $x \in E_0$ ning turli qiymatlarida ularga mos ketma-ketlik, umuman aytganda, turlicha bo'ladi).

3- ta'rif. Agar $\forall \varepsilon > 0$ son olinganda ham shu $\varepsilon > 0$ gagina bog'liq bo'lgan natural $n_0 = n_0(\varepsilon)$ son topilsaki, $\forall n > n_0$ va ixtiyoriy $x \in E_0$ da

$$|f_n(x) - f(x)| < \varepsilon$$

tengsizlik bajarilsa, ya'ni

$$\forall \varepsilon > 0, \exists n_0 = n_0(\varepsilon) \in N, \forall n > n_0, \forall x \in E_0 : |f_n(x) - f(x)| < \varepsilon$$

bo'lsa, $\{f_n(x_0)\}$ funksional ketma-ketlik E_0 to'plamda $f(x)$ ga tekis yaqinlashadi (funksional ketma-ketlik E_0 to'plamda *tekis yaqinlashuvchi*) deyiladi.

Shunday qilib, $\{f_n(x_0)\}$ funksional ketma-ketlik E_0 to'plamda $f(x)$ limit funksiyaga ega bo'lsa, uning shu limit funksiyasiga yaqinalishish ikki xil bo'lar ekan:

$$1) \forall \varepsilon > 0, \exists n_0 = n_0(\varepsilon, x) \in N, \forall n > n_0 : |f_n(x) - f(x)| < \varepsilon$$

bo'lsa, $\{f_n(x)\}$ funksional ketma-ketlik E_0 da $f(x)$ ga yaqinlashadi (oddiy yaqinlashadi). Bu holda

$$f_n(x) \rightarrow f(x), \quad (x \in E_0)$$

kabi belgilanadi.

$$2) \forall \varepsilon > 0, \exists n_0 = n_0(\varepsilon) \in N, \forall n > n_0, \forall x \in E_0 : |f_n(x) - f(x)| < \varepsilon$$

bo'lsa, $\{f_n(x)\}$ funksional ketma-ketlik E_0 da $f(x)$ ga tekis yaqinlashadi. Bu holda

$$f_n(x) \rightrightarrows f(x), \quad (x \in E_0)$$

kabi belgilanadi.

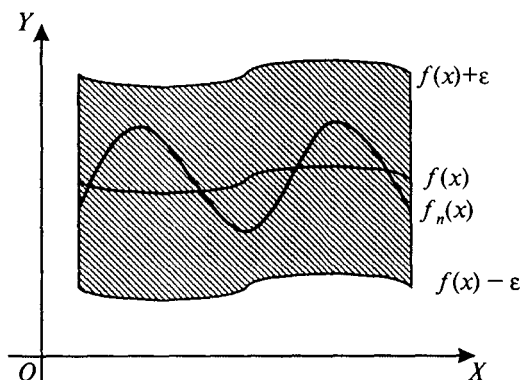

29- chizma.

Ravshanki, $\{f_n(x)\}$ funksional ketma-ketlik E_0 to'plamda $f(x)$ funksiyaga tekis yaqinlashsa, u ushbu to'plamda $f(x)$ ga yaqinlashadi:

$$f_n(x) \rightrightarrows f(x) \Rightarrow f_n(x) \rightarrow f(x), \quad (x \in E_0).$$

Aytaylik, $f_n(x) \rightrightarrows f(x), \quad (x \in E_0)$

bo'lsin. Bu holda $\forall n > n_0$ va $\forall x \in E_0$ da

$$|f_n(x) - f(x)| < \varepsilon, \text{ ya'ni } f(x) - \varepsilon < f_n(x) < f(x) + \varepsilon$$

bo'ladi. Bu esa $\{f_n(x)\}$ funksional ketama-ketlikning biror hadidan boshlab, keyingi barcha hadlari $f(x)$ funksiyaning « ε -oralig'i»da butunlay joylashishini bildiradi (29- chizma)

4- misol. Ushbu

$$f_n(x) = \frac{\sin nx}{n}$$

funksional ketma-ketlikning R da tekis yaqinlashuvchanligi ko'rsatilsin.

◀ Ravshanki,

$$\lim_{n \rightarrow \infty} f_n(x) = \lim_{n \rightarrow \infty} \frac{\sin nx}{n} = 0.$$

Demak, limit funksiya $f(x) = 0$.

Agar $\forall \varepsilon > 0$ son olinganda $n_0 = \left[\frac{1}{\varepsilon} \right]$ deyilsa, u holda $\forall n > n_0$ va

$\forall x \in R$ uchun

$$|f_n(x) - f(x)| = \left| \frac{\sin nx}{n} - 0 \right| = \left| \frac{\sin nx}{n} \right| \leq \frac{1}{n} \leq \frac{1}{n_0+1} < \varepsilon$$

bo'lishini topamiz. Demak, ta'rifga binoan

$$\frac{\sin nx}{n} \rightarrow 0$$

bo'ladi. ►

Faraz qilaylik, $\{f_n(x)\}$ funksional ketma-ketlik E_0 to'plamda $f(x)$ limit funksiyaga ega bo'lsin.

1- teorema. $\{f_n(x)\}$ funksional ketma-ketlik E_0 to'plamda $f(x)$ funksiyaga tekis yaqilashishi uchun

$$\lim_{n \rightarrow \infty} \sup_{x \in E_0} |f_n(x) - f(x)| = 0$$

bo'lishi zarur va yetarli.

◀ **Zarurligi.** Aytaylik,

$$f_n(x) \rightrightarrows f(x), \quad (x \in E_0)$$

bo'lsin. Ta'rifga binoan

$$\forall \varepsilon > 0, \exists n_0 = n_0(\varepsilon) \in \mathbb{N}, \forall n > n_0, \forall x \in E_0 : |f_n(x) - f(x)| < \varepsilon$$

bo'ladi. Bu tengsizlikdan

$$\sup_{x \in E_0} |f_n(x) - f(x)| \leq \varepsilon$$

bo'lib, undan

$$\lim_{n \rightarrow \infty} \sup_{x \in E_0} |f_n(x) - f(x)| = 0$$

bo'lishi kelib chiqadi.

Yetarliligi. Aytaylik

$$\lim_{n \rightarrow \infty} \sup_{x \in E_0} |f_n(x) - f(x)| = 0$$

bo'lsin. Limit ta'rifga ko'ra

$$\forall \varepsilon > 0, \exists n_0 \in \mathbb{N}, \forall n > n_0 : \sup_{x \in E_0} |f_n(x) - f(x)| < \varepsilon$$

bo'ladi. Ravshanki

$$|f_n(x) - f(x)| \leq \sup_{x \in E_0} |f_n(x) - f(x)|.$$

U holda $\forall x \in E_0$ uchun

$$|f_n(x) - f(x)| < \varepsilon$$

bo'ladi. Bundan

$$f_n(x) \rightarrow f(x), \quad (x \in E_0)$$

bo'lishi kelib chiqadi. ►

5- misol. Ushbu $f_n(x) = \sqrt{x^2 + \frac{1}{n^2}}$

funksional ketma-ketlikning $E_0 = R$ da tekis yaqinlashuvchiligi ko'rsatilsin.

◀ Berilgan funksional ketma-ketlikning limit funksiyasi

$$f(x) = \lim_{n \rightarrow \infty} f_n(x) = \lim_{n \rightarrow \infty} \sqrt{x^2 + \frac{1}{n^2}} = |x|, \quad (x \in R)$$

bo'ladi. Endi $\sup_x |f_n(x) - f(x)|$

ni topamiz:

$$\sup_{x \in R} \left| \sqrt{x^2 + \frac{1}{n^2}} - |x| \right| = \sup_{x \in R} \left| \frac{\frac{1}{n^2}}{\left(\sqrt{x^2 + \frac{1}{n^2}} + |x| \right)} \right| = \sup_{x \in R} \frac{1}{n^2} \cdot \frac{1}{\left(\sqrt{x^2 + \frac{1}{n^2}} + |x| \right)} = \frac{1}{n}.$$

Demak, $\lim_{n \rightarrow \infty} \sup_{x \in R} \left| \sqrt{x^2 + \frac{1}{n^2}} - |x| \right| = \lim_{n \rightarrow \infty} \frac{1}{n} = 0$

bo'lib, $\sqrt{x^2 + \frac{1}{n^2}} \rightarrow |x|, \quad (x \in R)$

ifodaga ega bo'lamiz. ►

Eslatma. Agar $\{f_n(x)\}$ funksional ketma-ketlik uchun $E \subset R$ to'plamda

$$\lim_{n \rightarrow \infty} \sup_{x \in E} |f_n(x) - f(x)| \neq 0$$

bo'lsa, $\{f_n(x)\}$ funksional ketma-ketlik E da tekis yaqinlashishi shart emas.

Endi funksional ketma-ketlikning limit funksiyaga ega bo'lishi va unga tekis yaqinlashishini ifodalovchi teoremani keltiramiz.

2- teorema. (Koshi teoremasi.) $\{f_n(x)\}$ funksional ketma-ketlik E to'plamda limit funksiyaga ega bo'lishi va unga tekis yaqinlashishi uchun $\forall \varepsilon > 0$ son olinganda ham shunday $n_0 = n_0(\varepsilon) \in N$ topilib, $\forall n > n_0, \forall p \in N$ va $\forall x \in E$ da

$$|f_{n+p}(x) - f_n(x)| < \varepsilon,$$

ya'ni $\forall \varepsilon > 0, \exists n_0 = n_0(\varepsilon) \in N, \forall n > n_0, \forall p \in N$ va $\forall x \in E$ da

$$|f_{n+p}(x) - f_n(x)| < \varepsilon \quad (2)$$

bo'lishi zarur va yetarli.

◀ **Zarurligi.** Aytaylik, E to'plamda $\{f_n(x)\}$ funksional ketma-ketlik limit funksiya $f(x)$ ga ega bo'lib, unga tekis yaqinlashsin:

$$f_n(x) \rightrightarrows f(x), \quad (x \in E_0).$$

Tekis yaqinlashish ta'rifiga ko'ra

$$\forall \varepsilon > 0, \exists n_0 = n_0(\varepsilon) \in N, \forall k > n_0, \forall x \in E : |f_k(x) - f(x)| < \frac{\varepsilon}{2}$$

bo'ladi. Xususan, $k = n, n > n_0$ va $k = n + p, p \in N$ da

$$|f_n(x) - f(x)| < \frac{\varepsilon}{2}, \quad |f_{n+p}(x) - f(x)| < \frac{\varepsilon}{2}$$

tengsizliklar bajarilib, ulardan

$$\begin{aligned} |f_{n+p}(x) - f_n(x)| &= |f_{n+p}(x) - f(x) - (f_n(x) - f(x))| \leq \\ &\leq |f_{n+p}(x) - f(x)| + |f_n(x) - f(x)| < \frac{\varepsilon}{2} + \frac{\varepsilon}{2} = \varepsilon \end{aligned}$$

bo'lishi kelib chiqadi. Demak, (2) shart o'rinli.

Yetarliligi. $\{f_n(x)\}$ funksional ketma-ketlik uchun (2) shart bajarilsin. Uni quyidagicha yozamiz:

$$\forall \varepsilon > 0, \exists n_0 = n_0(\varepsilon) \in N, \forall n > n_0, \forall p \in N, \forall x \in E$$

$$|f_{n+p}(x) - f_n(x)| < \frac{\varepsilon}{2} \quad (3)$$

bo'ladi.

Ravshanki, tayin $x_0 \in E$ da $\{f_n(x)\}$ sonlar ketma-ketligi uchun (3) shartning bajarilishidan uning fundamental ketma-ketlik ekanligi kelib chiqadi. Koshi teoremasiga ko'ra $\{f_n(x_0)\}$ yaqinlashuvchi bo'ladi. Bino-barin, chekli

$$\lim_{n \rightarrow \infty} f_n(x_0) \quad (4)$$

limit mavjud.

Modomiki, har bir $x \in E$ da (4) limit mavjud bo'lar ekan, u holda avval aytganimizdek, E to'plamda aniqlangan

$$x \rightarrow \lim_{n \rightarrow \infty} f_n(x), \quad (x \in E)$$

funksiya hosil bo'ladi. Uni $f(x)$ bilan belgilaymiz. Bu funksiya $\{f_n(x)\}$ funksional ketma-ketlikning limit funksiyasi bo'ladi:

$$f_n(x) \rightarrow f(x), \quad (x \in E).$$

Endi (3) tengsizlikda n va x larni tayinlab ($n > n_0, x \in E$) $p \rightarrow \infty$ da limitga o'tamiz. Natijada

$$|f(x) - f_n(x)| \leq \frac{\varepsilon}{2} < \varepsilon$$

hosil bo'ladi. Bu quyidagicha bo'lishini bildiradi:

$$f_n(x) \rightrightarrows f(x), \quad (x \in E_0). \blacktriangleright$$

6- misol. Ushbu

$$f_n(x) = \frac{\ln nx}{\sqrt{nx}}$$

funksional ketma-ketlik $E = (0,1)$ to'plamda tekis yaqinlashuvchanlikka tekshirilsin.

◀ Agar ixtiyoriy $k \in N$ uchun

$$n = k, \quad p = k = n, \quad x^* = \frac{1}{k} = \frac{1}{n}$$

deyilsa,

$$\left| f_{n+p}(x) - f(x) \right| = \left| f_{2n}\left(\frac{1}{n}\right) - f_n\left(\frac{1}{n}\right) \right| = \left| \frac{\ln 2}{\sqrt{2}} - \ln 1 \right| = \frac{\ln 2}{\sqrt{2}} = \varepsilon_0$$

bo'ladi. Demak,

$$\exists \varepsilon_0 = \frac{\ln 2}{\sqrt{2}} \forall k \in N, \exists n \geq k, \exists p \in N,$$

$$\exists x^* = \frac{1}{n} \in (0,1): \left| f_{n+p}(x^*) - f_n(x^*) \right| \geq \varepsilon_0.$$

Bu esa yuqoridagi teorema shartining bajarilmasligini ko'rsatadi. Demak, berilgan funksional ketma-ketlik $E=(0,1)$ da tekis yaqinlashuvchi emas. \blacktriangleright

Aytaylik, $\{f_n(x)\}$ funksional ketma-ketlik E to'plamda yaqinlashuvchi bo'lib, $f(x)$ funksiya uning limit funksiyasi bo'lsin:

$$f_n(x) \rightarrow f(x), \quad (x \in E).$$

Agar

$$\exists \varepsilon_0 > 0, \quad \forall k \in N, \quad \exists n > k, \quad \exists x^* \in E: \quad |f_n(x^*) - f(x^*)| \geq \varepsilon_0$$

bo'lsa, $\{f_n(x)\}$ funksional ketma-ketlik E to'plamda $f(x)$ funksiyaga notekis yaqinlashadi deyiladi.

7- misol. Ushbu $f_n(x) = n \sin \frac{1}{nx}$

funksional ketma-ketlik $E = (0, 1)$ da tekis yaqinlashuvchanlikka tekshirilsin.

◀ Ravshanki, $\lim_{n \rightarrow \infty} f_n(x) = \lim_{n \rightarrow \infty} n \sin \frac{1}{nx} = \lim_{n \rightarrow \infty} \frac{\sin \frac{1}{nx}}{\frac{1}{nx}} = \frac{1}{x}$.

Demak, berilgan funksional ketma-ketlikning limit funksiyasi $f(x) = \frac{1}{x}$ bo'ladi.

Aytaylik, $x^* = \frac{1}{n}$ bo'lsin. U holda

$$|f_n(x^*) - f(x^*)| = |n \sin 1 - n| \geq 1 - \sin 1 = \varepsilon_0$$

munosabat ixtiyoriy $n \in N$ da o'rinli bo'ladi.

Demak, $f_n(x) = n \sin \frac{1}{nx}$ funksional ketma-ketlik limit funksiya

$f(x) = \frac{1}{x}$ ga $E = (0, 1)$ da tekis yaqinlashmaydi. ▶

3°. Tekis yaqinlashuvchi funksional ketma-ketlikning xossalari. Tekis yaqinlashuvchi funksional ketma-ketliklar qator xossalarga ega. Bu xossalarni keltiramiz.

Aytaylik, $\{f_n(x)\}$:

$$f_1(x), f_2(x), \dots, f_n(x), \dots$$

funksional ketma-ketlik $E \subset R$ to'plamda yaqinlashuvchi bo'lib, $f(x)$ uning limit funksiyasi bo'lsin:

$$f_n(x) \rightarrow f(x), \quad (x \in E).$$

1- xossa. Agar $\{f_n(x)\}$ funksional ketma-ketlikning har bir $f_n(x)$, ($n=1,2,3,\dots$) hadi E to'plamda uzluksiz bo'lib,

$$f_n(x) \rightrightarrows f(x), \quad (x \in E)$$

bo'lsa, limit funksiya $f(x)$ shu E to'plamda uzluksiz bo'ladi. Demak, bu holda

$$\lim_{t \rightarrow x} (\lim_{n \rightarrow \infty} f_n(t)) = \lim_{n \rightarrow \infty} (\lim_{t \rightarrow x} f_n(t))$$

munosabat o'rinli bo'ladi.

2- xossa. Agar $\{f_n(x)\}$ funksional ketma-ketlikning har bir $f_n(x)$, ($n=1,2,3,\dots$) hadi $E = [a,b]$ da uzluksiz bo'lib,

$$f_n(x) \rightrightarrows f(x), \quad (x \in [a, b])$$

bo'lsa,

$$\lim_{n \rightarrow \infty} \int_a^b f_n(x) dx = \int_a^b f(x) dx$$

bo'ladi. Demak, bu holda

$$\lim_{n \rightarrow \infty} \int_a^b f_n(x) dx = \int_a^b \left(\lim_{n \rightarrow \infty} f_n(x) \right) dx$$

munosabat o'rinli bo'ladi.

3- xossa. Agar $\{f_n(x)\}$ funksional ketma-ketlikning har bir $f_n(x)$, ($n=1,2,3,\dots$) hadi $E = [a,b]$ da uzluksiz $f'_n(x)$, ($n = 1, 2, 3, \dots$) hosilalarga ega bo'lib,

$$f'_n(x) \rightrightarrows \varphi(x), \quad (x \in [a, b])$$

bo'lsa,

$$\varphi(x) = f'(x)$$

ga ega bo'lamiz.

Shu kabi xossalarga keyinroq o'rganiladigan tekis yaqinlashuvchi funksional qatorlar ham ega bo'ladi. Ayni paytda, ular bir mulohaza asosida isbotlanadi. Mazkur xossalarning isbotini funksional qatorlarga nisbatan keltiramiz.

Mashqlar

1. Ushbu $f_n(x) = n\left(\sqrt{x + \frac{1}{n}} - \sqrt{x}\right)$ funksional ketma-ketlik $E = (0, +\infty)$ da tekis yaqinlashuvchanlikka tekshirilsin.

2. Aytaylik, $f(x)$ funksiya (a, b) da uzluksiz $f'(x)$ hosilaga ega bo'lib,

$$f_n(x) = n\left(f\left(x + \frac{1}{n}\right) - f(x)\right)$$

bo'lsin. Bu funksional ketma-ketlikning $[a, b] \subset (a, b)$ da $f'(x)$ ga tekis yaqinlashishi isbotlansin.

66- ma'ruza

Funksional qatorlar va ularning tekis yaqinlashuvchanligi

1°. **Funksional qator va uning yig'indisi.** Faraz qilaylik, $E \subset \mathbb{R}$ to'plamda aniqlangan

$$u_1(x), u_2(x), \dots, u_n(x), \dots$$

funksional ketma-ketlik berilgan bo'lsin. Bu ketma-ketlik hadlari yordamida tuzilgan quyidagi

$$u_1(x) + u_2(x) + \dots + u_n(x) + \dots$$

ifoda *funksional qator* deyiladi va $\sum_{n=1}^{\infty} u_n(x)$ kabi belgilanadi:

$$\sum_{n=1}^{\infty} u_n(x) = u_1(x) + u_2(x) + \dots + u_n(x) + \dots \quad (1)$$

Bunda E – funksional qatorning aniqlanish to'plami deyiladi. Masalan,

$$1) \sum_{n=1}^{\infty} x^{n-1} = 1 + x + x^2 + \dots + x^{n-1} + \dots,$$

$$2) \sum_{n=1}^{\infty} ne^{nx} = e^x + 2e^{2x} + 3e^{3x} + \dots + ne^{nx} + \dots$$

funksional qatorlar bo‘lib, ularning aniqlanish to‘plami $E = (-\infty, +\infty)$ bo‘ladi. (1) funksional qator hadlaridan ushbu

$$\begin{aligned}
 S_1(x) &= u_1(x), \\
 S_2(x) &= u_1(x) + u_2(x), \\
 &\dots\dots\dots \\
 S_n(x) &= u_1(x) + u_2(x) + \dots + u_n(x), \\
 &\dots\dots\dots
 \end{aligned}
 \tag{2}$$

yig‘indilarni tuzamiz. Ular **(1) funksional qatorning qisman yig‘indilari** deyiladi. Demak, (1) funksional qator berilgan holda har doim bu qatorning (2) qisman yig‘indilaridan iborat $\{S_n(x)\}$:

$$S_1(x), S_2(x), \dots, S_n(x), \dots$$

funksional ketma-ketlik hosil bo‘ladi. Ravshanki, $x = x_0 \in E$ nuqtada $\{S_n(x_0)\}$ sonlar ketma-ketligi bo‘ladi.

1-ta’rif. Agar $\{S_n(x_0)\}$ yaqinlashuvchi (uzoqlashuvchi) bo‘lsa,

$\sum_{n=1}^{\infty} u_n(x)$ funksional qator $x = x_0$ nuqtada yaqinlashuvchi (uzoqlashuvchi) deyiladi, x_0 nuqta funksional qatorning yaqinlashish (uzoqlashish) nuqtasi deyiladi.

2-ta’rif. $\sum_{n=1}^{\infty} u_n(x)$ funksional qatorning barcha yaqinlashish nuqtalaridan iborat $E \subset E_0$ to‘plam, $\sum_{n=1}^{\infty} u_n(x)$ funksional qatorning

yaqinlashish to‘plami deyiladi. Bu holda $\sum_{n=1}^{\infty} u_n(x)$ funksional qator

E_0 to‘plamda yaqinlashuvchi deb ham yuritiladi.

Agar E_0 to‘plamda ushbu

$$\sum_{n=1}^{\infty} |u_n(x)| = |u_1(x)| + |u_2(x)| + \dots + |u_n(x)| + \dots$$

qator yaqinlashuvchi bo‘lsa, $\sum_{n=1}^{\infty} u_n(x)$ funksional qator E_0 da *absolut yaqinlashuvchi* deyiladi.

3- ta'rif. $\sum_{n=1}^{\infty} u_n(x)$ funksional qatorning qisman yig'indilaridan iborat $\{S_n(x)\}$ ketma-ketlikning limit funksiyasi $S(x)$:

$$S_n(x) \rightarrow S(x), \quad (x \in E_0),$$

$\sum_{n=1}^{\infty} u_n(x)$ funksional qator yig'indisi deyiladi va quyidagicha yoziladi:

$$\sum_{n=1}^{\infty} u_n(x) = S(x), \quad (x \in E_0).$$

1- misol. Ushbu $\sum_{n=1}^{\infty} x^{n-1} = 1 + x + x^2 + \dots + x^{n-1} + \dots$

funksional qatorning yaqinlashish to'plami va yig'indisi topilsin.

◀ Berilgan funksional qatorning aniqlanish to'plami $E = R$ bo'ladi. Qatorning qisman yig'indisini topamiz:

$$S_n(x) = 1 + x + x^2 + \dots + x^{n-1} = \begin{cases} \frac{1-x^n}{1-x}, & \text{agar } x \neq 1 \\ n, & \text{agar } x = 1. \end{cases}$$

Ravshanki, $n \rightarrow \infty$ da $S_n(x)$ ning limiti x ga bog'liq bo'ladi:

a) $x \in (-1, 1)$ da $\lim_{n \rightarrow \infty} S_n(x) = \lim_{n \rightarrow \infty} \left(\frac{1}{1-x} - \frac{x^n}{1-x} \right) = \frac{1}{1-x}$;

b) $x \in [1, +\infty)$ da $\lim_{n \rightarrow \infty} S_n(x) = \infty$;

d) $x \in (-\infty, -1]$ da $\lim_{n \rightarrow \infty} S_n(x)$ mavjud emas.

Demak, berilgan funksional qatorning yaqinlashish to'plami $E_0 = (-1, 1)$ bo'lib, yig'indisi

$$S(x) = \frac{1}{1-x}$$

ga teng bo'ladi. ▶

2- misol. Ushbu $\sum_{n=1}^{\infty} \frac{x^n}{1+x^{2n}}$ funksional qatorning yaqinlashish to'plami topilsin.

◀ Sonli qatorlar nazariyasidagi Dalamber alomatidan foydalanib topamiz:

$$\lim_{n \rightarrow \infty} \left| \frac{u_{n+1}(x)}{u_n(x)} \right| = \lim_{n \rightarrow \infty} \left| \frac{x^{n+1}}{1+x^{2n+2}} : \frac{x^n}{1+x^{2n}} \right| = \lim_{n \rightarrow \infty} \left| \frac{x(1+x^{2n})}{1+x^{2n+2}} \right|;$$

a) $x \in (-1, 1)$ da $\lim_{n \rightarrow \infty} \left| \frac{x(1+x^{2n})}{1+x^{2n+2}} \right| = |x|$.

Bu holda berilgan funksional qator $(-1, 1)$ da yaqinlashuvchi bo'ladi.

b) $x \in (-\infty, -1) \cup (1, +\infty)$ da

$$\lim_{n \rightarrow \infty} \left| \frac{x(1+x^{2n})}{1+x^{2n+2}} \right| = \lim_{n \rightarrow \infty} \left| \frac{\frac{1}{x^{2n+1}} + \frac{1}{x}}{\frac{1}{x^{2n+2}} + 1} \right| = \left| \frac{1}{x} \right|$$

bo'lib, funksional qator $x \in (-\infty, -1) \cup (1, +\infty)$ da yaqinlashuvchi bo'ladi.

d) $x = \pm 1$ da berilgan funksional qator mos ravishda ushbu

$$\sum_{n=1}^{\infty} \frac{1}{2^n}, \quad \sum_{n=1}^{\infty} \frac{(-1)^n}{2^n}$$

sonli qatorga aylanadi va ular uzoqlashuvchi bo'ladi.

Shunday qilib, qaralayotgan funksional qatorning yaqinlashish to'plami

$$E_0 = R \setminus \{-1, 1\} = (-\infty, -1) \cup (-1, 1) \cup (1, +\infty)$$

bo'ladi. ►

2°. Funksional qatorning tekis yaqinlashuvchanligi. Aytaylik,

$$\sum_{n=1}^{\infty} u_n(x) = u_1(x) + u_2(x) + \dots + u_n(x) + \dots$$

funksional qator E_0 to'plamda yaqinlashuvchi (ya'ni qatorning yaqinlashish to'plami E_0) bo'lib, yig'indisi $S(x)$ bo'lsin:

$$S_n(x) \rightarrow S(x), \quad (x \in E_0), \quad (3)$$

bunda $S_n(x) = u_1(x) + u_2(x) + \dots + u_n(x)$. (3) munosabat

$\forall \varepsilon > 0, \forall x \in E_0, \exists n_0 = n_0(\varepsilon, x) \in \mathbb{N}, \forall n > n_0: |S_n(x) - S(x)| < \varepsilon$
bo'lishini anglatadi.

4- ta'rif. Agar E_0 to'plamda

$$S_n(x) \rightrightarrows S(x), \quad (x \in E_0)$$

ya'ni

$$\forall \varepsilon > 0, \exists n_0 = n_0(\varepsilon) \in \mathbb{N}, \forall n > n_0, \forall x \in E_0: |S_n(x) - S(x)| < \varepsilon$$

bo'lsa, $\sum_{n=1}^{\infty} u_n(x)$ funksional qator E_0 to'plamda tekis yaqinlashuvchi

deyiladi. Agar

$$r_n(x) = S(x) - S_n(x)$$

deyilsa, funksional qatorning E_0 to'plamda tekis yaqinlashuvchanligini quyidagicha

$$r_n(x) \rightrightarrows 0, \quad (x \in E_0),$$

ya'ni

$\forall \varepsilon > 0, \exists n_0 = n_0(\varepsilon) \in \mathbb{N}, \forall n > n_0, \forall x \in E_0: |r_n(x)| < \varepsilon$
ko'rinishda ta'riflash mumkin bo'ladi. Shunday qilib,

$$\sum_{n=1}^{\infty} u_n(x) = u_1(x) + u_2(x) + \dots + u_n(x) + \dots$$

funksional qator, uning qisman yig'indisi

$$S_n(x) = u_1(x) + u_2(x) + \dots + u_n(x)$$

va yig'indisi $S(x)$ uchun

$$S_n(x) \rightarrow S(x), \quad (x \in E_0)$$

bo'lsa, funksional qator E_0 da yaqinlashuvchi;

$$S_n(x) \rightrightarrows S(x), \quad (x \in E_0)$$

bo'lsa, funksional qator E_0 da tekis yaqinlashuvchi bo'ladi.

1- teorema. $\sum_{n=1}^{\infty} u_n(x)$ funksional qator E_0 da qator yig'indisi $S(x)$ funksiyaga tekis yaqinlashishi uchun

$$\lim_{n \rightarrow \infty} \sup_{x \in E_0} |S_n(x) - S(x)| = 0,$$

ya'ni

$$\lim_{n \rightarrow \infty} \sup_{x \in E_0} |r_n(x)| = 0$$

bo'lishi zarur va yetarli.

◀ Bu teoremaning isboti ravshan (qaralsin, 65- ma'ruza, 1-teorema.) ▶

3- misol. Ushbu
$$\sum_{n=1}^{\infty} \frac{1}{(x+n)(x+n+1)}$$

funksional qatorning $[0, +\infty)$ da tekis yaqinlashuvchi bo'lishi isbotlansin.

◀ Berilgan funksional qatorning qisman yig'indisini hisoblab, so'ng- ra yig'indisini topamiz:

$$\begin{aligned} S_n(x) &= \frac{1}{(x+1)(x+2)} + \frac{1}{(x+2)(x+3)} + \dots + \frac{1}{(x+n)(x+n+1)} = \\ &= \left(\frac{1}{x+1} - \frac{1}{x+2} \right) + \left(\frac{1}{x+2} - \frac{1}{x+3} \right) + \dots + \left(\frac{1}{x+n} - \frac{1}{x+n+1} \right) = \frac{1}{x+1} - \frac{1}{x+n+1}, \\ \lim_{n \rightarrow \infty} S_n(x) &= \lim_{n \rightarrow \infty} \left(\frac{1}{x+1} - \frac{1}{x+n+1} \right) = \frac{1}{x+1}. \end{aligned}$$

Demak,
$$S(x) = \frac{1}{x+1}.$$

U holda
$$S_n(x) - S(x) = \frac{1}{x+1} - \frac{1}{x+n+1} - \frac{1}{x+1} = -\frac{1}{x+n+1}$$
 bo'lib,

$$\sup_{x \in [0, +\infty)} |S_n(x) - S(x)| = \frac{1}{n+1}$$

ga ega bo'lamiz. Keyingi tenglikdan

$$\lim_{n \rightarrow \infty} \sup_{x \in [0, +\infty)} |S_n(x) - S(x)| = 0$$

bo'lishi kelib chiqadi. 1- teoreмага ko'ra berilgan funksional qator $[0, +\infty)$ da tekis yaqinlashuvchi. ▶

Eslatma. Agar $\lim_{n \rightarrow \infty} \sup_{x \in [0, +\infty)} |S_n(x) - S(x)| \neq 0$

bo'lsa, $\sum_{n=1}^{\infty} u_n(x)$ funksional qator E_0 da tekis yaqinlashuvchi bo'lishi shart emas. Masalan,

$$\sum_{n=1}^{\infty} x^{n-1} = 1 + x + x^2 + \dots + x^{n-1} + \dots$$

funksional qatorning $(-1, 1)$ da yaqinlashuvchi, yig'indisi

$$S(x) = \frac{1}{1-x}$$

bo'lishini ko'rgan edik. Bu funksional qator uchun

$$\lim_{n \rightarrow \infty} \sup_{-1 < x < 1} |S_n(x) - S(x)| = \lim_{n \rightarrow \infty} \sup_{-1 < x < 1} \left| \frac{x^n}{1-x} \right| = +\infty$$

bo'ladi. Demak, funksional qator $(-1, 1)$ da tekis yaqinlashuvchi emas. Faraz qilaylik,

$$\sum_{n=1}^{\infty} u_n(x) = u_1(x) + u_2(x) + \dots + u_n(x) + \dots$$

funksional qator to'plamda berilgan bo'lsin.

2- teorema. (Koshi teoremasi.) $\sum_{n=1}^{\infty} u_n(x)$ funksional qator E to'plamda tekis yaqinlashuvchi bo'lishi uchun

$\forall \varepsilon > 0, \exists n_0 = n_0(\varepsilon) \in \mathbb{N}, \forall n > n_0, \forall p \in \mathbb{N}, \forall x \in E$ da

$$|S_{n+p}(x) - S_n(x)| = |u_{n+1}(x) + u_{n+2}(x) + \dots + u_{n+p}(x)| < \varepsilon$$

bo'lishi zarur va yetarli.

Bu tenglamaning isboti 65- ma'ruzadagi 2- teoremadan kelib chiqadi.

3°. Funksional qatorlarning tekis yaqinlashuvchanlik alomatlari.

a) Veyershtrass atomati. Aytaylik, E to'plamda

$$\sum_{n=1}^{\infty} u_n(x) = u_1(x) + u_2(x) + \dots + u_n(x) + \dots \quad (4)$$

funksional qator berilgan bo'lib,

1) $\forall n \in N, \forall x \in E$ da $|u_n(x)| \leq C_n$,

2) $\sum_{n=1}^{\infty} C_n = C_1 + C_2 + \dots + C_n + \dots$ sonli qator yaqinlashuvchi bo'lsa,

U holda (4) funksional qator E to'plamda tekis yaqinlashuvchi bo'ladi.

◀ 1- shartga ko'ra $\forall n > n_0, \forall p \in N$ va $\forall x \in E$ uchun

$$\begin{aligned} |u_{n+1}(x) + u_{n+2}(x) + \dots + u_{n+p}(x)| &\leq |u_{n+1}(x)| + |u_{n+2}(x)| + \dots + |u_{n+p}(x)| \\ &\leq C_{n+1} + C_{n+2} + \dots + C_{n+p} \end{aligned}$$

bo'lib, 2- shartdan, ya'ni $\sum_{n=1}^{\infty} C_n$ qatorning yaqinlashuvchanligidan

Koshi teoremasiga binoan

$\forall \varepsilon > 0, \exists n_0 = n_0(\varepsilon) \in N, \forall n > n_0, \forall p \in N$ da

$$C_{n+1} + C_{n+2} + \dots + C_{n+p} < \varepsilon$$

bo'ladi. Demak,

$$|u_{n+1}(x) + u_{n+2}(x) + \dots + u_{n+p}(x)| < \varepsilon.$$

Yuqoridagi 2- teoreмага ko'ra $\sum_{n=1}^{\infty} u_n(x)$ funksional qator E to'plamda tekis yaqinlashuvchi bo'ladi. ▶

4-misol. Ushbu $\sum_{n=1}^{\infty} \frac{x \sin x}{\sqrt{1+n^2}(1+nx^2)}$ funksional qator tekis yaqinlashuvchanlikka tekshirilsin.

◀ Berilgan qatorning aniqlanish to'plami $E = (-\infty, +\infty)$ bo'lib, uning umumiy hadi

$$u_n(x) = \frac{x \sin x}{\sqrt{1+n^2}(1+nx^2)}, \quad (n = 1, 2, 3, \dots)$$

bo'ladi. Ravshanki,

$$|u_n(x)| = \left| \frac{x \sin x}{\sqrt{1+n^2}(1+nx^2)} \right| \leq \frac{|x|}{\sqrt{1+n^2}(1+nx^2)}.$$

Endi $\forall x \in (-\infty, +\infty)$ uchun

$$\frac{|x|}{1+nx^2} \leq \frac{1}{2\sqrt{n}}$$

bo'lishini e'tiborga olib topamiz:

$$\frac{|x|}{\sqrt{1+n^2}(1+nx^2)} \leq \frac{1}{2\sqrt{n}(1+n^2)} \leq \frac{1}{2n^{3/2}}.$$

Demak, berilgan funksional qatorning hadlari uchun

$$|u_n(x)| \leq \frac{1}{2n^{3/2}}$$

bo'ladi. Ma'lumki, $\sum_{n=1}^{\infty} \frac{1}{n^{3/2}}$ qator yaqinlashuvchi. Binobarin, Veyer-shtrass alomatiga ko'ra berilgan funksional qator $(-\infty, +\infty)$ da tekis yaqinlashuvchi bo'ladi. ►

Funksional qatorlarning tekis yaqinlashishini ifodalovchi keyingi alomatlarini isbotsiz keltiramiz.

b) Dirixle alomati. Aytaylik, $E \subset R$ to'plamda aniqlangan $u_n(x)$ va $v_n(x)$. ($n = 1, 2, 3, \dots$) funksiyalar quyidagi shartlarni bajarsin:

- 1) $\forall x \in E$ da $\{u_n(x)\}$ ketma-ketlik monoton;
- 2) $\{u_n(x)\}$ funksional ketma-ketlik E da 0 ga tekis yaqinlashuvchi:

$$u_n(x) \rightrightarrows 0, \quad (x \in E);$$

- 3) shunday $C \in R$ mavjudki, $\forall n \in N, \forall x \in E$ da

$$|v_1(x) + v_2(x) + \dots + v_n(x)| = \left| \sum_{k=1}^n v_k(x) \right| \leq C.$$

U holda
$$\sum_{n=1}^{\infty} u_n(x) \cdot v_n(x)$$

funksional qator E to'plamda tekis yaqinlashuvchi bo'ladi.

5- misol. Ushbu
$$\sum_{n=1}^{\infty} \frac{\sin x \cdot \sin nx}{\sqrt{n+x}}$$

funksional qator $E = [0, +\infty)$ da tekis yaqinlashuvchiligi isbotlansin.

◀ Aytaylik,

$$u_n(x) = \frac{1}{\sqrt{n+x}}, \quad v_n(x) = \sin x \cdot \sin nx$$

bo'lsin. Bu funksiyalar uchun Dirixle alomatidagi uchta shart bajariladi. Haqiqatan ham,

$$1) \forall x \in E \text{ da } u_n(x) = \frac{1}{\sqrt{n+x}} \text{ uchun}$$

$$\frac{1}{\sqrt{n+x}} - \frac{1}{\sqrt{n+1+x}} = \frac{\sqrt{n+1+x} - \sqrt{n+x}}{\sqrt{n+x} \cdot \sqrt{n+1+x}} = \frac{1}{\sqrt{(n+x)(n+1+x)}(\sqrt{n+1+x} + \sqrt{n+x})} > 0$$

bo'lganligidan, uning kamayuvchiligi kelib chiqadi;

$$2) \text{ Ravshanki, } u_n(x) = \frac{1}{\sqrt{n+x}} \leq \frac{1}{\sqrt{n}}, \quad n \rightarrow \infty \text{ da } \frac{1}{\sqrt{n}} \rightarrow 0.$$

Demak, $u_n(x) \rightarrow 0, (x \in E)$.

3) Bu holda

$$\left| \sum_{k=1}^n v_k(x) \right| = \left| \sum_{k=1}^n \sin x \sin kx \right| = 2 \left| \cos \frac{x}{2} \right| \left| \sin \frac{nx}{2} \cdot \sin \frac{n+1}{2} x \right| \leq 2$$

bo'ladi.

Dirixle alomatiga ko'ra berilgan funksional qator $E = [0, +\infty)$ da tekis yaqinlashuvchi. ▶

d) Abel alomati. Aytaylik, $E \subset R$ to'plamda aniqlangan $u_n(x)$ va $v_n(x)$, $(n = 1, 2, 3, \dots)$ funksiyalar quyidagi shartlarni bajarsin:

- 1) $\forall x \in E$ da $\{u_n(x)\}$ ketma-ketlik monoton;
- 2) shunday $C \in R$ topiladiki, $\forall n \in N, \forall x \in E$ da

$$|u_n(x)| \leq C;$$

- 3) $\sum_{n=1}^{\infty} v_n(x)$ funksional qator E to'plamda tekis yaqinlashuvchi.

U holda

$$\sum_{n=1}^{\infty} u_n(x) \cdot v_n(x)$$

funksional qator to'plamda tekis yaqinlashuvchi bo'ladi.

6- misol. Ushbu
$$\sum_{n=1}^{\infty} \frac{(-1)^{n+1}}{n} x^n$$

funksional qatorning $E=[0, 1]$ da tekis yaqinlashuvchi ekanligi isbotlansin.

◀ Aytaylik, $u_n(x) = x^n$, $v_n(x) = \frac{(-1)^{n+1}}{n}$, ($x \in [0, 1]$)

bo'lsin. Bu funksiyalar uchun Abel alomatidagi uchta shart bajariladi (bu ravshan). U holda Abel alomatiga ko'ra berilgan funksional qator $[0, 1]$ da tekis yaqinlashuvchi bo'ladi. ▶

Mashqlar

1. Agar $\sum_{n=1}^{\infty} u_n(x)$, ($x \in E$) funksional qator E to'plamda tekis yaqinlashuvchi bo'lsa, $\{u_n(x)\}$ funksional ketma-ketlikning E to'plamda 0 ga tekis yaqinlashishi isbotlansin.

2. Ushbu $\sum_{n=1}^{\infty} \frac{(-1)^{n+1}}{n+x^2} \arctg nx$, ($x \in R$) funksional qator R da tekis yaqinlashuvchi ekanligi isbotlansin.

67- ma'ruza

Tekis yaqinlashuvchi funksional qatorlarning xossalari

1°. Funksional qator yig'indisining uzluksizligi. Faraz qilaylik, $E \subset R$ to'plamda

$$\sum_{n=1}^{\infty} u_n(x) = u_1(x) + u_2(x) + \dots + u_n(x) + \dots \quad (1)$$

funksional qator berilgan bo'lib, uning yig'indisi $S(x)$ bo'lsin.

1- teorema. Aytaylik, (1) qator ushbu shartlarni bajarsin:

1) qatorning har bir $u_n(x)$, ($n = 1, 2, 3, \dots$) hadi E to'plamda uzluksiz;

2) $\sum_{n=1}^{\infty} u_n(x)$ qator E da tekis yaqinlashuvchi. U holda funksional qatorning yig'indisi $S(x)$ funksiya E to'plamda uzluksiz bo'ladi.

◀ Aytaylik, $x_0 \in E$,

$$S_n(x) = u_1(x) + u_2(x) + \dots + u_n(x)$$

bo'lsin. Teoremaning 2- shartiga ko'ra

$$S_n(x) \rightrightarrows S(x), \quad (x \in E)$$

bo'ladi. Ta'rifga binoan

$$\forall \varepsilon > 0, \exists n_0 = n_0(\varepsilon) \in \mathbb{N}, \quad \forall n > n_0 \text{ va } \forall x \in E \text{ da}$$

$$|S_n(x) - S(x)| < \frac{\varepsilon}{3}, \quad (2)$$

$$\text{jumladan,} \quad |S_n(x_0) - S(x_0)| < \frac{\varepsilon}{3} \quad (3)$$

tengsizliklar bajariladi.

Ravshanki, (2) va (3) tengsizliklar n ning n_0 dan katta biror muayyan n_1 qiymatida ham o'rinli bo'ladi:

$$|S_{n_1}(x) - S(x)| < \frac{\varepsilon}{3}, \quad (2')$$

$$|S_{n_1}(x_0) - S(x_0)| < \frac{\varepsilon}{3}. \quad (3')$$

Teoremaning 1- shartidan va chekli sondagi uzluksiz funksiyalar yig'indisi yana uzluksiz bo'lishidan

$$S_{n_1}(x) = u_1(x) + u_2(x) + \dots + u_{n_1}(x)$$

funksiyaning E to'plamda uzluksiz ekanligi kelib chiqadi. Demak, $S_{n_1}(x)$ funksiya $x = x_0$ da uzluksiz. U holda, ta'rifga binoan $\forall \varepsilon > 0, \exists \delta = \delta(\varepsilon) > 0, |x - x_0| < \delta$ tengsizlikni qanoatlantiruvchi barcha $x \in E$ da

$$|S_{n_1}(x) - S_{n_1}(x_0)| < \frac{\varepsilon}{3} \quad (4)$$

bo'ladi. Yuqoridagi (2'), (3') va (4) tengsizliklardan foydalanib topamiz:

$$\begin{aligned} |S(x) - S(x_0)| &= |(S(x) - S_{n_1}(x)) + (S_{n_1}(x) - S_{n_1}(x_0)) + (S_{n_1}(x_0) - S(x_0))| \leq \\ &\leq |S(x) - S_{n_1}(x)| + |S_{n_1}(x) - S_{n_1}(x_0)| + |S_{n_1}(x_0) - S(x_0)| < \frac{\varepsilon}{3} + \frac{\varepsilon}{3} + \frac{\varepsilon}{3} = \varepsilon. \end{aligned}$$

Bu esa $S(x)$ funksiyaning x_0 nuqtada uzluksiz bo'lishini bildiradi. Modomiki, x_0 nuqta E to'plamning ixtiyoriy nuqtasi ekan, $S(x)$ funksiya E to'plamda uzluksiz bo'ladi. ►

Yuqorida keltirilgan teoremaning shartlari bajarilganda uning tasdig'ini quyidagicha ifodalash mumkin:

$$\lim_{x \rightarrow x_0} \sum_{n=1}^{\infty} u_n(x) = \sum_{n=1}^{\infty} \left(\lim_{x \rightarrow x_0} u_n(x) \right).$$

2°. Funktsional qatorlarni hadlab integrallash. Faraz qilaylik, $[a, b]$ segmentda

$$\sum_{n=1}^{\infty} u_n(x) = u_1(x) + u_2(x) + \dots + u_n(x) + \dots \quad (5)$$

funksional qator berilgan bo'lsin.

2- teorema. Aytaylik, (5) qator quyidagi shartlarni bajarsin:

1) qatorning har bir $u_n(x)$, ($n = 1, 2, 3, \dots$) hadi $[a, b]$ segmentda uzluksiz;

2) $\sum_{n=1}^{\infty} u_n(x)$ qator $[a, b]$ segmentda tekis yaqinlashuvchi;

3) $\sum_{n=1}^{\infty} u_n(x) = S(x)$.

$$\text{U holda} \quad \sum_{n=1}^{\infty} \int_a^x u_n(t) dt = \int_a^x u_1(t) dt + \int_a^x u_2(t) dt + \dots$$

qator $[a, b]$ da yaqinlashuvchi va

$$\sum_{n=1}^{\infty} \int_a^x u_n(t) dt = \int_a^x S(t) dt, \quad (x \in [a, b])$$

bo'ladi.

◀ Berilgan funktsional qatorning qisman yig'indisi

$$S_n(x) = u_1(x) + u_2(x) + \dots + u_n(x)$$

ni olamiz. U holda teoremaning 2- va 3- shartlariga ko'ra

$$S_n(x) \rightrightarrows S(x), \quad (x \in [a, b])$$

bo'ladi. Tekis yaqinlashish ta'rifiga binoan $\forall \varepsilon > 0, \exists n_0 = n_0(\varepsilon) \in \mathbb{N}, \forall n > n_0$ va $\forall t \in [a, b]$ da

$$|S_n(t) - S(t)| < \frac{\varepsilon}{b-a}$$

tengsizlik bajariladi.

Teoremaning 1- shartidan hamda yuqorida isbot etilgan 1- teoremandan foydalanib

$$\int_a^x u_n(t) dt, \quad (n = 1, 2, 3, \dots); \quad \int_a^x S(t) dt$$

integrallarning mavjudligini topamiz. Ushbu

$$\sum_{n=1}^{\infty} \int_a^x u_n(t) dt = \int_a^x u_1(t) dt + \int_a^x u_2(t) dt + \dots + \int_a^x u_n(t) dt + \dots$$

funktional qatorni qaraymiz. Bu qatorning qisman yig'indisi

$$\sigma_n(x) = \sum_{k=1}^n \int_a^x u_k(t) dt, \quad (x \in [a, b])$$

bo'lsin. Ravshanki,

$$\sum_{k=1}^n \int_a^x u_k(t) dt = \int_a^x \left(\sum_{k=1}^n u_k(t) \right) dt.$$

Demak,
$$\sigma_n(x) = \int_a^x S_n(t) dt.$$

Endi
$$\sum_{n=1}^{\infty} \int_a^x u_n(t) dt$$

funktional qatorning $[a, b]$ da tekis yaqinlashuvchi ekanligini ko'rsatamiz. Quyidagi

$$\left| \sigma_n(x) - \int_a^x S(t) dt \right|$$

ayirma uchun

$$\begin{aligned} \left| \sigma_n(x) - \int_a^x S(t) dt \right| &= \left| \int_a^x S_n(t) dt - \int_a^x S(t) dt \right| \leq \\ &\leq \int_a^x |S_n(t) - S(t)| dt < \frac{\varepsilon}{b-a} \int_a^x dt = \frac{\varepsilon}{b-a} \cdot (x-a) < \varepsilon \end{aligned}$$

bo'ladi. Demak,

$$\sigma_n(x) \rightarrow \int_a^x S(t)dt, \quad (x \in [a, b]).$$

Bu esa
$$\sum_{n=1}^{\infty} \int_a^x u_n(t)dt$$

funksional qatorning $[a, b]$ da tekis yaqinlashuvchi va

$$\sum_{n=1}^{\infty} \int_a^x u_n(t)dt = \int_a^x S(t)dt$$

bo'lishini bildiradi. ►

Keltirilgan teoremaning shartlari bajarilganda teoremaning tasdiq'ini quyidagicha ifodalash mumkin:

$$\sum_{k=1}^{\infty} \int_a^x u_k(t)dt = \int_a^x \left(\sum_{k=1}^{\infty} u_k(t) \right) dt.$$

3°. Funksional qatorlarni hadlab differensiallash. Faraz qilaylik, $[a, b]$ segmentda

$$\sum_{n=1}^{\infty} u_n(x) = u_1(x) + u_2(x) + \dots + u_n(x) + \dots \quad (6)$$

funksional qator berilgan bo'lsin.

3- teorema. Aytaylik, (6) funksional qator quyidagi shartlarni bajarsin:

1) Qatorning har bir $u_n(x)$, $(n = 1, 2, 3, \dots)$ hadi $[a, b]$ segmentda uzluksiz $u'_n(x)$, $(n = 1, 2, 3, \dots)$ hosilaga ega;

2) Ushbu

$$\sum_{n=1}^{\infty} u'_n(x) = u'_1(x) + u'_2(x) + \dots + u'_n(x) + \dots$$

funksional qator $[a, b]$ da tekis yaqinlashuvchi;

3) $x_0 \in [a, b]$ nuqta mavjudki, bunda

$$\sum_{n=1}^{\infty} u_n(x_0) = u_1(x_0) + u_2(x_0) + \dots + u_n(x_0) + \dots$$

qator yaqinlashuvchi. U holda

a) $\sum_{n=1}^{\infty} u_n(x)$ funksional qator $[a, b]$ da tekis yaqinlashuvchi;

b) bu qatorning yig'indisi

$$S(x) = \sum_{n=1}^{\infty} u_n(x)$$

$[a, b]$ da uzluksiz $S'(x)$ hosilaga ega;

d) $S'(x) = \sum_{n=1}^{\infty} u'_n(x)$ bo'ladi.

◀ Ushbu $\sum_{n=1}^{\infty} u'_n(x)$

qatorning yig'indisini $\sigma(x)$ bilan belgilaylik:

$$\sigma(x) = \sum_{n=1}^{\infty} u'_n(x). \quad (7)$$

Bu qator tekis yaqinlashuvchi va har bir hadi $[a, b]$ da uzluksiz. Yuqorida keltirilgan 2- teorema ko'ra (7) ni hadlab integrallash mumkin:

$$\int_{x_0}^x \sigma(x) dx = \sum_{n=1}^{\infty} \int_{x_0}^x u'_n(x) dx,$$

bunda $x_0 \in [a, b]$, $x \in [a, b]$. Ayni paytda,

$\sum_{n=1}^{\infty} \int_{x_0}^x u'_n(x)$ funksional qator $[a, b]$ da tekis yaqinlashuvchi.

Ravshanki, $\int_{x_0}^x u'_n(x) dx = u_n(x) - u_n(x_0)$.

Demak, $\sum_{n=1}^{\infty} (u_n(x) - u_n(x_0))$ qator $[a, b]$ da tekis yaqinlashuvchi.

Shartga ko'ra

$$\sum_{n=1}^{\infty} u_n(x_0)$$

qator yaqinlashuvchi (uni $[a, b]$ da tekis yaqinlashuvchi deb qarash mumkin). Shunday qilib

$$\sum_{n=1}^{\infty} (u_n(x) - u_n(x_0)), \quad \sum_{n=1}^{\infty} u_n(x_0)$$

qatorlar $[a, b]$ da tekis yaqinlashuvchi bo'ladi. Bundan esa bu qatorlarning yig'indisi bo'lgan

$$\sum_{n=1}^{\infty} u_n(x)$$

funktional qatorning $[a, b]$ da tekis yaqinlashuvchi ekanligi kelib chiqadi. Shuni e'tiborga olib topamiz:

$$\int_{x_0}^x \sigma(x) dx = \sum_{n=1}^{\infty} (u_n(x) - u_n(x_0)) = \sum_{n=1}^{\infty} u_n(x) - \sum_{n=1}^{\infty} u_n(x_0) = S(x) - S(x_0).$$

$\sigma(x)$ funksiya har bir hadi uzluksiz, o'zi tekis yaqinlashuvchi

$$\sum_{n=1}^{\infty} u'_n(x)$$

qatorning yig'indisi bo'lgani uchun 1- teorema ko'ra, $[a, b]$ da uzluksiz bo'ladi. U holda keyingi tenglikdan

$$\sigma(x) = (S(x) - S(x_0))' = S'(x)$$

bo'lishi kelib chiqadi. Demak,

$$\sum_{n=1}^{\infty} u'_n(x)$$

qator yig'indisi uzluksiz hosilaga ega va

$$S'(x) = \sum_{n=1}^{\infty} u'_n(x)$$

bo'ladi. ►

Bu keltirilgan teoremaning shartlari bajarilganda uning tasdig'ini quyidagicha yozish mumkin:

$$\frac{d}{dx} \left(\sum_{n=1}^{\infty} u_n(x) \right) = \sum_{n=1}^{\infty} \left(\frac{d}{dx} u_n(x) \right).$$

1- misol. Ushbu $\sum_{n=1}^{\infty} \ln \frac{(n+1)(n+x)}{n(n+1+x)}$, ($0 \leq x \leq +\infty$)

funksional qatorning yig'indisi topilsin.

◀ Ma'lumki, $\sum_{n=1}^{\infty} \frac{1}{(n+x)(n+1+x)}$

funksional qator $[0, +\infty)$ da tekis yaqinlashuvchi bo'lib, uning yig'indisi

$$S(x) = \frac{1}{1+x}$$

ga teng (qaralsin, 66- ma'ruza):

$$\frac{1}{1+x} = \sum_{n=1}^{\infty} \frac{1}{(n+x)(n+1+x)}.$$

Ravshanki, bu qatorning har bir hadi $[0, +\infty)$ da uzluksiz. Demak, uni 2- teorema ko'ra hadlab integrallash mumkin:

$$\int_0^x \frac{dt}{1+t} = \sum_{n=1}^{\infty} \int_0^x \frac{dt}{(n+t)(n+1+t)}.$$

Aniq integrallarni hisoblaymiz:

$$\begin{aligned} \int_0^x \frac{dt}{1+t} &= \ln(1+t)|_0^x = \ln(1+x), \\ \int_0^x \frac{1}{(n+t)(n+1+t)} dt &= \int_0^x \left(\frac{1}{n+t} - \frac{1}{n+1+t} \right) dt = \\ &= \ln(n+t)|_0^x - \ln(n+1+t)|_0^x = \ln \frac{(n+1)(n+x)}{n(n+1+x)}. \end{aligned}$$

Demak, $\sum_{n=1}^{\infty} \ln \frac{(n+1)(n+x)}{n(n+1+x)} = \ln(1+x)$. ▶

Mashqlar

1. Ushbu $\sum_{n=1}^{\infty} nx^n$, $(-1 < x < 1)$ funksional qatorning yig'indisi topilsin.

2. Ushbu $S(x) = \sum_{n=1}^{\infty} \frac{1}{n^2 + x^2}$, $(x \in R)$ funksiya funksional qatorni hadlab differensiallash bilan topilsin.

68- ma'ruza

Darajali qatorlar, ularning yaqinlashish radiusi va yaqinlashish intervallari

1°. Darajali qator tushunchasi. Abel teoremasi. Har bir hadi

$$u_n(t) = a_n (t - t_0)^n, \quad (t_0 \in R; \quad n = 0, 1, 2, \dots)$$

funksiyadan iborat bo'lgan ushbu

$$\sum_{n=0}^{\infty} a_n (t - t_0)^n = a_0 + a_1 (t - t_0) + a_2 (t - t_0)^2 + \dots \quad (1)$$

funksional qator *darajali qator* deyiladi, bunda

$$a_0, a_1, \dots, a_n, \dots$$

haqiqiy sonlar *darajali qatorning koeffitsiyentlari* deyiladi.

(1) da $t - t_0 = x$ deyilsa, u quyidagi

$$\sum_{n=0}^{\infty} a_n x^n = a_0 + a_1 x + a_2 x^2 + \dots + a_n x^n + \dots, \quad (x \in R) \quad (2)$$

ko'rinishga keladi va biz shu ko'rinishdagi darajali qatorlarni o'rganamiz.

Ravshanki, (2) qatorning qisman yig'indisi

$$S_n(x) = a_0 + a_1 x + a_2 x^2 + \dots + a_n x^n$$

ko'phaddan iborat. Ayni paytda, $x = 0$ da $S_n(0) = a_0$ bo'ladi. Demak, har qanday (2) ko'rinishdagi darajali qator $x = 0$ nuqtada yaqinlashuvchi bo'ladi.

1- teorema. (Abel teoremasi). Agar

$$\sum_{n=0}^{\infty} a_n x^n = a_0 + a_1 x + a_2 x^2 + \dots + a_n x^n + \dots$$

darajali qator $x = x_0 \neq 0$ nuqtada yaqinlashuvchi bo'lsa, ushbu

$$|x| < |x_0|,$$

tengsizlikni qanoatlantiruvchi barcha x larda darajali qator yaqinlashuvchi (absolut yaqinlashuvchi) bo'ladi.

◀ Aytaylik, $x = x_0 \neq 0$ da

$$\sum_{n=0}^{\infty} a_n x_0^n$$

qator yaqinlashuvchi bo'lsin. Qator yaqinlashishining zaruriy shartiga ko'ra

$$\lim_{n \rightarrow \infty} a_n x_0^n = 0$$

bo'ladi. Demak, $\{a_n x_0^n\}$ ketma-ketlik chegaralangan:

$$\exists M > 0, \forall n \in N \text{ da } |a_n x_0^n| \leq M.$$

Ravshanki, $|a_n x^n| = |a_n x_0^n| \left| \frac{x}{x_0} \right|^n \leq M \cdot \left| \frac{x}{x_0} \right|^n$ (3)

va $|x| < |x_0|$, da $\left| \frac{x}{x_0} \right| = q < 1$ bo'ladi. Demak, $\sum_{n=0}^{\infty} \left| \frac{x}{x_0} \right|^n = \sum_{n=0}^{\infty} q^n$

geometrik qator yaqinlashuvchi. U holda ushbu

$$\sum_{n=0}^{\infty} M \left| \frac{x}{x_0} \right|^n$$

qator ham yaqinlashuvchi bo'ladi. (3) munosabatni e'tiborga olib, so'ngra solishtirish teoremasidan foydalanib,

$$\sum_{n=0}^{\infty} a_n x^n$$

darajali qatorning yaqinlashishini (absolut yaqinlashishini) topamiz. ▶

Natija. Agar $\sum_{n=0}^{\infty} a_n x^n = a_0 + a_1 x + a_2 x^2 + \dots + a_n x^n + \dots$

darajali qator $x = x_1$ nuqtada uzoqlashuvchi (ushbu

$$\sum_{n=0}^{\infty} a_n x_1^n = a_0 + a_1 x_1 + a_2 x_1^2 + \dots + a_n x_1^n + \dots$$

sonli qator uzoqlashuvchi) bo'lsa, quyidagi

$$|x| > |x_1|,$$

tengsizlikni qanoatlantiruvchi barcha x larda $\sum_{n=0}^{\infty} a_n x^n$ qator uzoqlashuvchi bo'ladi.

◀ Teskarisini faraz qilaylik. $\sum_{n=0}^{\infty} a_n x^n$ qator $|x| > x_1$ tengsizlikni

qanoatlantiruvchi biror $x = x^*$ nuqtada ($|x^*| > |x_1|$) yaqinlashuvchi bo'lsin. U holda Abel teoremasiga ko'ra $|x| < |x^*|$ tengsizlikni qanoatlantiruvchi barcha x larda yaqinlashuvchi, jumladan, x_1 nuqtada ham yaqinlashuvchi bo'lib qoladi. Bu esa shartga ziddir. ▶

Abel teoremasi va uning natijasi darajali qatorlarning yaqinlashish (uzoqlashish) to'plamining strukturasi (tuzilishini) aniqlab beradi.

2°. Darajali qatorning yaqinlashish radiusi va yaqinlashish intervali. Faraz qilaylik,

$$\sum_{n=0}^{\infty} a_n x^n = a_0 + a_1 x + a_2 x^2 + \dots + a_n x^n + \dots$$

darajali qator berilgan bo'lsin. Bu qatorning yaqinlashish yoki uzoqlashish nuqtalari haqida quyidagi uch hol bo'lishi mumkin:

- 1) barcha musbat sonlar qatorning yaqinlashish nuqtalari bo'ladi;
- 2) barcha musbat sonlar qatorning uzoqlashish nuqtalari bo'ladi;
- 3) shunday musbat sonlar borki, ular qatorning yaqinlashish nuqtalari bo'ladi, shunday musbat sonlar borki, ular qatorning uzoqlashish nuqtalari bo'ladi.

Birinchi holda, Abel teoremasiga ko'ra darajali qator barcha $x \in R$ da yaqinlashuvchi bo'lib, darajali qatorning yaqinlashish to'plami $E = (-\infty, +\infty)$ bo'ladi. Bunday qatorga ushbu

$$\sum_{n=0}^{\infty} \frac{1}{n!} x^n = 1 + x + \frac{1}{2!} x^2 + \dots + \frac{1}{n!} x^n + \dots$$

darajali qator misol bo'ladi.

Ikkinchi holda, Abel teoremasining natijasiga ko'ra darajali qator barcha $x \in \mathbb{R} \setminus \{0\}$ da uzoqlashuvchi bo'lib, uning yaqinlashish to'plami $E = \{0\}$ bo'ladi. Bunday qatorga ushbu

$$\sum_{n=1}^{\infty} n! x^n = x + 2! x^2 + 3! x^3 + \dots + n! x^n + \dots$$

darajali qator misol bo'loladi.

Endi uchunchi holni qaraymiz. Bu holga ushbu

$$\sum_{n=0}^{\infty} x^n = 1 + x + x^2 + \dots + x^n + \dots$$

darajali qator misol bo'ladi. Bu darajali qator barcha $x \in (0, 1)$ da yaqinlashuvchi va demak, Abel teoremasiga ko'ra qator $(-1, 1)$ da yaqinlashadi, barcha $x \in [1, +\infty)$ da qator uzoqlashuvchi va demak, Abel teoremasining natijasiga ko'ra qator $(-\infty, -1] \cup [1, +\infty)$ da uzoqlashadi. Demak, darajali qatorning yaqinlashish to'plami $E = (-1, 1)$ bo'ladi.

Aytaylik,
$$\sum_{n=0}^{\infty} a_n x^n = a_0 + a_1 x + a_2 x^2 + \dots + a_n x^n + \dots$$

darajali qator r_1 nuqtada ($r_1 > 0$) yaqinlashuvchi, R_1 nuqtada ($R_1 > 0$) nuqtada esa uzoqlashuvchi bo'lsin. Ravshanki,

$$r_1 > R_1$$

bo'ladi. Agar $\sum_{n=0}^{\infty} a_n x^n$ darajali qator

$$\frac{r_1 + R_1}{2}$$

nuqtada yaqinlashuvchi bo'lsa,

$$r_2 = \frac{r_1 + R_1}{2}, R_2 = R_1$$

deb; uzoqlashuvchi bo'lsa,

$$r_2 = r_1, \quad R_2 = \frac{r_1 + R_1}{2}$$

deb r_2 va R_2 nuqtalarni olamiz. Ravshanki,

$$r_1 \leq r_2, \quad R_1 \geq R_2 \quad \text{va} \quad R_2 - r_2 = \frac{R_1 - r_1}{2}$$

bo'ladi. Bu munosabatdagi r_2 va R_2 sonlarga ko'ra r_3 va R_3 sonlarni yuqoridagiga o'xshash aniqlaymiz.

Agar $\sum_{n=0}^{\infty} a_n x^n$ darajali qator

$$\frac{r_1 + R_1}{2}$$

nuqtada yaqinlashuvchi bo'lsa,

$$r_3 = \frac{r_2 + R_2}{2}, \quad R_3 = R_2$$

deb; uzoqlashuvchi bo'lsa,

$$r_3 = r_2, \quad R_3 = \frac{r_2 + R_2}{2}$$

deb r_3 va R_3 nuqtalarni olamiz. Bunda quyidagicha bo'ladi.:

$$r_2 \leq r_3, \quad R_2 \geq R_3 \quad \text{va} \quad R_3 - r_3 = \frac{R_1 - r_1}{2^2}$$

Bu jarayonni davom ettirib borilsa, $\sum_{n=0}^{\infty} a_n x^n$ darajali qatorning

yaqinlashish nuqtalaridan iborat $\{r_n\}$, uzoqlashish nuqtalaridan iborat $\{R_n\}$ ketma-ketliklar hosil bo'ladi. Bunda

$$r_1 \leq r_2 \leq \dots \leq r_n \leq \dots, \quad R_1 \geq R_2 \geq \dots \geq R_n \geq \dots$$

va $n \rightarrow \infty$ da $R_n - r_n = \frac{R_1 - r_1}{2^{n-1}} \rightarrow 0$

bo'ladi. U holda [1], 3-bob, 8-§ da keltirilgan teorema ko'ra

$\lim_{n \rightarrow \infty} r_n$ va $\lim_{n \rightarrow \infty} R_n$ limitlar mavjud va

$$\lim_{n \rightarrow \infty} r_n = \lim_{n \rightarrow \infty} R_n$$

bo'ladi. Uni r bilan belgilaymiz:

$$\lim_{n \rightarrow \infty} r_n = \lim_{n \rightarrow \infty} R_n = r.$$

Endi x o'zgaruvchining $|x| < r$ tengsizlikni qanoatlantiruvchi ixtiyoriy qiymatini olaylik. U holda

$$\lim_{n \rightarrow \infty} r_n = r$$

bo'lishidan, shunday $n_0 \in \mathbb{N}$ topiladiki, bunda

$$|x| < r_{n_0} < r$$

bo'ladi. Binobarin, berilgan darajali qator r_{n_0} nuqtada, demak, qarayotgan x nuqtada yaqinlashuvchi bo'ladi.

x o'zgaruvchining $|x| > r$ tenglikni qanoatlantiruvchi ixtiyoriy qiymatini olaylik. Bunda

$$\lim_{n \rightarrow \infty} R_n = r$$

bo'lishidan, shunday $n_1 \in \mathbb{N}$ topiladiki,

$$|x| > R_{n_1} > r$$

bo'ladi. Binobarin, berilgan darajali qator R_{n_1} nuqtada, demak, qarayotgan x nuqtada uzoqlashuvchi bo'ladi.

Demak, 3- holda $\sum_{n=0}^{\infty} a_n x^n$ darajali qator uchun shunday musbat r soni mavjud bo'ladiki, $|x| < r$, ya'ni $\forall x \in (-r, r)$ da qator yaqinlashuvchi; $|x| > r$, ya'ni $\forall x \in (-\infty, -r) \cup (r, +\infty)$ da qator uzoqlashuvchi bo'ladi. $x = \pm r$ nuqtalarda $\sum_{n=0}^{\infty} a_n x^n$ darajali qator yaqinlashuvchi ham bo'lishi mumkin, uzoqlashuvchi ham bo'lishi mumkin.

1- ta'rif. Yuqorida keltirilgan r son $\sum_{n=0}^{\infty} a_n x^n$ darajali qatorning *yaqinlashish radiusi*, $(-r, r)$ interval esa darajali qatorning *yaqinlashish intervali* deyiladi.

Eslatma. 1- holda darajali qatorning yaqinlashish radiusi $r = +\infty$ deb, 2- holda darajali qatorning yaqinlashish radiusi $r = 0$ deb olinadi.

3°. Darajali qatorning yaqinlashish radiusini topish. Biror

$$\sum_{n=0}^{\infty} a_n x^n = a_0 + a_1 x + a_2 x^2 + \dots + a_n x^n + \dots$$

darajali qatorni qaraylik. Bu qator koeffitsiyentlaridan tuzilgan $\{a_n\}$, ($n = 0, 1, 2, \dots$) ketma-ketlik uchun

1) $\forall n \geq 0$ da $a_n \neq 0$,

2) $\lim_{n \rightarrow \infty} \left| \frac{a_n}{a_{n+1}} \right|$ mavjud bo'lsin. U holda $\sum_{n=0}^{\infty} a_n x^n$ darajali qatorning yaqinlashish radiusi quyidagicha bo'ladi:

$$r = \lim_{n \rightarrow \infty} \left| \frac{a_n}{a_{n+1}} \right|.$$

◀ Aytaylik, darajali qator uchun

$$\lim_{n \rightarrow \infty} \left| \frac{a_n}{a_{n+1}} \right| = L, \quad (a_n \neq 0, \quad n = 0, 1, 2, 3, \dots)$$

bo'lsin. Qaralayotgan $\sum_{n=0}^{\infty} a_n x^n$ darajali qatorda x ni parametr hisob-

lab, Dalamber alomatiga ko'ra uni yaqinlashishga tekshiramiz:

$$\lim_{n \rightarrow \infty} \left| \frac{a_{n+1} x^{n+1}}{a_n x^n} \right| = \lim_{n \rightarrow \infty} \left| \frac{a_{n+1}}{a_n} \right| \cdot |x| = |x| \lim_{n \rightarrow \infty} \left| \frac{1}{\frac{a_n}{a_{n+1}}} \right| = |x| \cdot \frac{1}{L}.$$

Demak, $\frac{|x|}{L} < 1$, ya'ni $|x| < L$

bo'lganda qator yaqinlashuvchi bo'ladi;

$$\frac{|x|}{L} > 1, \text{ ya'ni } |x| > L$$

bo'lganda darajali qator uzoqlashuvchi bo'ladi.

Bundan $\sum_{n=0}^{\infty} a_n x^n$ darajali qatorning yaqinlashish radiusi

$$r = L = \lim_{n \rightarrow \infty} \left| \frac{a_n}{a_{n+1}} \right| \quad (4)$$

bo'lishi kelib chiqadi. ►

1- misol. Ushbu

$$\sum_{n=0}^{\infty} \frac{n^n}{e^n n!} x^n, \quad (0! = 1)$$

darajali qatorning yaqinlashish radiusi topilsin.

◀ Bu qator uchun

$$a_n = \frac{n^n}{e^n n!}, \quad a_{n+1} = \frac{(n+1)^{n+1}}{e^{n+1} (n+1)!}$$

bo'ladi. Ravshanki,

$$\lim_{n \rightarrow \infty} \left| \frac{a_n}{a_{n+1}} \right| = \lim_{n \rightarrow \infty} \left| \frac{n^n}{e^n \cdot n!} \cdot \frac{e^{n+1} (n+1)!}{(n+1)^{n+1}} \right| = \lim_{n \rightarrow \infty} \frac{e}{\left(1 + \frac{1}{n}\right)^n} = 1.$$

Demak, berilgan darajali qatorning yaqinlashish radiusi $r = 1$ bo'ladi. ►

Ixtiyoriy darajali qatorning yaqinlashish radiusini aniqlab beradigan teoremani isbotsiz keltiramiz.

2- teorema. (Koshi–Adamar teoremasi.) Ushbu

$$\sum_{n=0}^{\infty} a_n x^n = a_0 + a_1 x + a_2 x^2 + \dots + a_n x^n + \dots$$

darajali qatorning yaqinlashish radiusi

$$r = \frac{1}{\lim_{n \rightarrow \infty} \sqrt[n]{|a_n|}} \quad (5)$$

bo'ladi. [1]

Eslatma. Agar $\lim_{n \rightarrow \infty} \sqrt[n]{|a_n|} = +\infty$ bo'lsa, $\sum_{n=0}^{\infty} a_n x^n$ darajali qatorning yaqinlashish radiusi $r = 0$ deb; $\lim_{n \rightarrow \infty} \sqrt[n]{|a_n|} = 0$ bo'lsa, $\sum_{n=0}^{\infty} a_n x^n$ darajali qatorning yaqinlashish radiusi $r = +\infty$ deb olinadi.

2- misol. Ushbu $\sum_{n=0}^{\infty} 2^n x^{5^n}$ darajali qatorning yaqinlashish radiusi topilsin.

◀ Avvalo $2x^5 = t$ deb olamiz. Natijada berilgan qator quyidagi

$$\sum_{n=0}^{\infty} t^n = 1 + t + t^2 + \dots + t^n + \dots$$

ko'rinishga keladi. Bu qatorning yaqinlashish radiusi (5) formulaga ko'ra

$$r = \frac{1}{\lim_{n \rightarrow \infty} \sqrt[n]{|a_n|}} = \frac{1}{\lim_{n \rightarrow \infty} \sqrt[5]{1}} = 1$$

bo'ladi. Demak, $|t| < 1$ da qator yaqinlashuvchi, $|t| > 1$ da qator uzoqlashuvchi. U holda

$|2x^5| < 1$, ya'ni $|x| < \frac{1}{\sqrt[5]{2}}$ da berilgan qator yaqinlashuvchi,

$|2x^5| > 1$, ya'ni $|x| > \frac{1}{\sqrt[5]{2}}$ da qator uzoqlashuvchi bo'ladi.

Berilgan darajali qatorning yaqinlashish radiusi $r = \frac{1}{\sqrt[5]{2}}$ bo'ladi. ▶

3- misol. Ushbu $\sum_{n=0}^{\infty} \frac{(-1)^n}{3^{n-1} \sqrt{n}} x^n$ darajali qatorning yaqinlashish to'plami topilsin.

◀ Ravshanki, $a_n = \frac{(-1)^n}{3^{n-1} \sqrt{n}}$, $a_{n+1} = \frac{(-1)^{n+1}}{3^n \sqrt{n+1}}$.

Berilgan darajali qatorning yaqinlashish radiusini (4) formulaga ko'ra topamiz:

$$r = \lim_{n \rightarrow \infty} \left| \frac{a_n}{a_{n+1}} \right| = \lim_{n \rightarrow \infty} \left| \frac{(-1)^n}{3^{n-1} \sqrt{n}} \cdot \frac{3^n \sqrt{n+1}}{(-1)^{n+1}} \right| = \lim_{n \rightarrow \infty} 3 \sqrt{\frac{n+1}{n}} = 3.$$

Darajali qator $x = -3$ nuqtada ushbu $\sum_{n=1}^{\infty} \frac{3}{\sqrt{n}}$ sonli qatorga aylanadi va bu sonli qator uzoqlashuvchi bo'ladi. $x = 3$ nuqtada esa

$\sum_{n=1}^{\infty} 3 \frac{(-1)^n}{\sqrt{n}}$ sonli qator hosil bo'ldi va bu qator Leybnits teoremasiga ko'ra yaqinlashuvchi bo'ldi. Demak, berilgan darajali qatorning yaqinlashish to'plami $E = (-3, 3]$ dan iborat. ►

Mashqlar

1. Agar $\sum_{n=0}^{\infty} a_n x^n$ darajali qatorning yaqinlashish radiusi $r > 0$ bo'lsa, ushbu

$$\sum_{n=0}^{\infty} (n^2 + 1) a_n x^n, \quad \sum_{n=0}^{\infty} \frac{1}{n+3} a_n x^n$$

darajali qatorlarning yaqinlashish radiuslari ham r ga teng bo'lishi isbotlansin.

2. Ushbu $\sum_{n=0}^{\infty} \frac{(n!)}{(2n)!} x^n$ darajali qatorning yaqinlashish intervali topilsin.

69- ma'ruza

Darajali qatorning tekis yaqinlashishi. Darajali qatorning xossalari

1°. Darajali qatorning tekis yaqinlashishi. Aytaylik, ushbu

$$\sum_{n=0}^{\infty} a_n x^n = a_0 + a_1 x + a_2 x^2 + \dots + a_n x^n + \dots \quad (1)$$

darajali qatorning yaqinlashish radiusi $r > 0$ bo'lsin.

1- teorema. (1) darajali qator $[\alpha, \beta] \subset (-r, r)$ da tekis yaqinlashuvchi bo'ldi, bunda $\alpha \in R, \beta \in R$.

◀ Ravshanki, (1) darajali qator $(-r, r)$ da absolut yaqinlashuvchi bo'ldi.

Aytaylik, $\alpha \in (0, r)$ bo'lsin. U holda $\forall n \geq 0$ va $\forall x \in [-\alpha, \alpha]$ da

$$|a_n x^n| \leq |a_n \alpha^n|$$

bo'lganligi uchun Veyershtrass alomatiga ko'ra, (1) qator $[-\alpha, \alpha]$ da tekis yaqinlashuvchi bo'ladi. ►

Demak, $\sum_{n=0}^{\infty} a_n x^n$ darajali qatorning yaqinlashish radiusi $r > 0$ bo'lsa,

yuqorida keltirilgan teorema ko'ra bu qator $[-c, c] \subset (-r, r)$ da tekis yaqinlashuvchi bo'ladi. Bunda c sonni r songa har qancha yaqin qilib olish mumkin bo'lsa-da, qator $(-r, r)$ da tekis yaqinlashmasdan qolishi mumkin. Masalan, ushbu

$$\sum_{n=0}^{\infty} x^n = 1 + x + x^2 + \dots + x^n + \dots$$

darajali qatorning yaqinlashish radiusi $r = 1$, biroq qator $(-1, 1)$ da tekis yaqinlashuvchi emas.

2°. Darajali qatorning xossalari. Ma'lumki, darajali qatorlar funksional qatorlarning xususiy holi. Binobarin, ular tekis yaqinlashuvchi funksional qatorlarning xossalari kabi xossalarga ega.

2- teorema. Agar

$$\sum_{n=0}^{\infty} a_n x^n = a_0 + a_1 x + a_2 x^2 + \dots + a_n x^n + \dots$$

darajali qatorning yaqinlashish radiusi $r > 0$ bo'lib, yig'indisi

$$S(x) = \sum_{n=0}^{\infty} a_n x^n$$

bo'lsa, $S(x)$ funksiya $(-r, r)$ da uzluksiz bo'ladi.

◀ Ravshanki, qaralayotgan darajali qator $(-r, r)$ da yaqinlashuvchi bo'ladi. Aytaylik, $x_0 \in (-r, r)$ bo'lsin. Ushbu

$$|x_0| < c < r$$

tengsizlikni qanoatlantiruvchi c sonni olaylik. U holda darajali qator $[-c, c]$ da tekis yaqinlashuvchi bo'ladi. Tekis yaqinlashuvchi funksional qatorning xossasiga ko'ra $\sum_{n=0}^{\infty} a_n x^n$ darajali qatorning yig'indisi $S(x)$

funksiya $[-c, c]$ da uzluksiz, jumladan, x_0 nuqtada uzluksiz. ►

3- teorema. Aytaylik, darajali qatorning yaqinlashish radiusi $r > 0$ bo'lib, yig'indisi $S(x)$ bo'lsin:

$$S(x) = \sum_{n=0}^{\infty} a_n x^n.$$

Bu qatorni $(-r, r)$ ga tegishli bo'lgan ixtiyoriy $[a, b]$ bo'yicha ($[a, b] \subset (-r, r)$) hadlab integrallash mumkin:

$$\int_a^b S(x) dx = \sum_{n=0}^{\infty} \left(\int_a^b a_n x^n dx \right).$$

Xususan, $\forall x \in (-r, r)$ uchun quyidagicha bo'ladi:

$$\int_0^x S(t) dt = \sum_{n=0}^{\infty} \frac{a_n}{n+1} x^{n+1}. \quad (2)$$

◀ Ravshanki, darajali qator $[a, b]$ da ($[a, b] \subset (-r, r)$) tekis yaqinlashuvchi bo'ladi. Tekis yaqinlashuvchi funksional qatorning xossasiga ko'ra uni hadlab integrallash mumkin. Ayni paytda, (2) qatorning yaqinlashish radiusi r ga teng bo'ladi. Haqiqatan ham, Koshi-Adamar teoremasiga ko'ra

$$\lim_{n \rightarrow \infty} \sqrt[n]{\left| \frac{a_n}{n+1} \right|} = \lim_{n \rightarrow \infty} \frac{\sqrt[n]{|a_n|}}{\sqrt[n]{n+1}} = \lim_{n \rightarrow \infty} \sqrt[n]{|a_n|} = r$$

ifodaga ega bo'lamiz. ►

Natija. Aytaylik, $\sum_{n=0}^{\infty} a_n x^n$ darajali qator berilgan bo'lib, uning yaqin-

lashish radiusi $r > 0$ bo'lsin. Bu qatorni $[0, x]$ bo'yicha ($\forall x_0 \in (-r, r)$) ixtiyoriy marta hadlab integrallash mumkin. Integrallash natijasida hosil bo'lgan darajali qatorning yaqinlashish radiusi ham r ga teng bo'ladi.

4- teorema. Faraz qilaylik,

$$\sum_{n=0}^{\infty} a_n x^n = a_0 + a_1 x + a_2 x^2 + \dots + a_n x^n + \dots$$

darajali qatorning yaqinlashish radiusi $r > 0$, yig'indisi $S(x)$ bo'lsin:

$$\sum_{n=0}^{\infty} a_n x^n = S(x).$$

U holda funksiya $(-r, r)$ da $S'(x)$ uzluksiz hosilaga ega va

$$S'(x) = \sum_{n=0}^{\infty} na_n x^{n-1} \quad (3)$$

bo'ladi, bunda (3) qatorning yaqinlashish radiusi ham r ga teng.

◀ Berilgan darajali qator $[-c, c]$ da $(0 < c < r)$ tekis yaqinlashuvchi bo'ladi. Tekis yaqinlashuvchi funksional qatorning xossasiga ko'ra darajali qatorni hadlab differensiallash mumkin. Demak, $\forall x_0 \in (-r, r)$ da

$$S'(x) = \sum_{n=0}^{\infty} (a_n x^n)' = \sum_{n=1}^{\infty} na_n x^{n-1}.$$

Bu darajali qatorning yaqinlashish radiusi ham r ga teng bo'lishi quyidagi munosabatdan kelib chiqadi:

$$\overline{\lim}_{n \rightarrow \infty} \sqrt[n]{|na_n|} = \overline{\lim}_{n \rightarrow \infty} (\sqrt[n]{n} \cdot \sqrt[n]{|a_n|}) = \overline{\lim}_{n \rightarrow \infty} \sqrt[n]{|a_n|}. \quad \blacktriangleright$$

Natija. Aytaylik, $\sum_{n=0}^{\infty} a_n x^n$ darajali qator berilgan bo'lib, uning yaqinlashish radiusi $r > 0$ bo'lsin. Bu qatorni $(-r, r)$ da ixtiyoriy marta hadlab differensiallash mumkin. Differensiallash natijasida hosil bo'lgan darajali qatorning yaqinlashish radiusi ham r ga teng bo'ladi.

5- teorema. Aytaylik,

$$\sum_{n=0}^{\infty} a_n x^n = a_0 + a_1 x + a_1 x^2 + \dots + a_n x^n + \dots$$

darajali qatorning yaqinlashish radiusi $r > 0$, yig'indisi $S(x)$ bo'lsin:

$$\sum_{n=0}^{\infty} a_n x^n = S(x). \quad (4)$$

U holda $\forall n \geq 0$ da

$$a_n = \frac{S^{(n)}(0)}{n!}$$

bo'ladi.

◀ (4) munosabatda $x = 0$ deb topamiz:

$$a_0 = S(0).$$

(4) qatorni hadlab differensiallaymiz:

$$S'(x) = \sum_{n=0}^{\infty} (a_n x^n)' = \sum_{n=0}^{\infty} n a_n x^{n-1}.$$

Bu tenglikda $x = 0$ deyilsa

$$a_0 = S'(0)$$

bo'lishi kelib chiqadi. Shu jarayonni davom ettirib

$$a_n = \frac{S^{(n)}(0)}{n!}, \quad (n = 2, 3, \dots)$$

bo'lishini topamiz. ►

1- misol. Ushbu
$$\sum_{n=1}^{\infty} n x^n = x + 2x^2 + 3x^3 + \dots + n x^n + \dots$$

darajali qator yig'indisi topilsin.

◀ Ma'lumki, $\sum_{n=1}^{\infty} x^n$ darajali qator $(-1, 1)$ da yaqinlashuvchi va uning yig'indisi $\frac{x}{1-x}$ ga teng:

$$\sum_{n=1}^{\infty} x^n = \frac{x}{1-x}.$$

Bu qatorni hadlab differensiallab topamiz:

$$\frac{d}{dx} \left(\sum_{n=1}^{\infty} x^n \right) = \frac{d}{dx} \left(\frac{x}{1-x} \right), \quad \sum_{n=1}^{\infty} n x^{n-1} = \frac{1}{(1-x)^2}.$$

Keyingi tenglikning har ikki tomonini x ga ko'paytirsak,

$$\sum_{n=1}^{\infty} n x^n = \frac{x}{(1-x)^2}$$

bo'lishi kelib chiqadi. ►

2- misol. Ushbu
$$\sum_{n=0}^{\infty} \frac{(-1)^n}{n+1} x^{n+1} = \ln(1+x)$$

tenglikning to'g'riligi isbotlansin.

◀ Ravshanki, $\sum_{n=0}^{\infty} x^n$ darajali qator $(-1, 1)$ da yaqinlashuvchi bo'lib, uning yig'indisi $\frac{1}{1-x}$ ga teng:

$$\sum_{n=0}^{\infty} x^n = \frac{1}{1-x}.$$

Bu tenglikda x ni $-x$ ga almashtirsak, natijada

$$\sum_{n=0}^{\infty} (-1)^n x^n = \frac{1}{1+x}$$

tenglik hosil bo'ladi. Uni $[0, x]$ bo'yicha ($0 < x < 1$) integrallab topamiz:

$$\begin{aligned} \int_0^x \sum_{n=0}^{\infty} (-1)^n t^n dt &= \int_0^x \frac{dt}{1+t}, \\ \sum_{n=0}^{\infty} (-1)^n \int_0^x t^n dt &= \ln(1+t)|_0^x, \\ \sum_{n=0}^{\infty} (-1)^n \frac{x^{n+1}}{n+1} &= \ln(1+x). \end{aligned}$$

3- misol. Ushbu
$$\sum_{n=0}^{\infty} \frac{(-1)^n}{2n+1} x^{2n+1}$$

darajali qator yig'indisi topilsin va undan foydalanib

$$\sum_{n=0}^{\infty} \frac{(-1)^n}{2n+1} = \frac{\pi}{4}$$

bo'lishi ko'rsatilsin.

◀ Ma'lumki,
$$\sum_{n=0}^{\infty} x^n = \frac{1}{1-x}, \quad (-1 < x < 1).$$

Bu tenglikda x ni $-x^2$ ga almashtiramiz. Natijada
$$\sum_{n=0}^{\infty} (-1)^n x^{2n} = \frac{1}{1+x^2}$$

hosil bo'ladi. Uni $[0, x]$ bo'yicha ($0 < x < 1$) integrallab topamiz:

$$\begin{aligned} \int_0^x \left(\sum_{n=0}^{\infty} (-1)^n t^{2n} \right) dt &= \int_0^x \frac{dt}{1+t^2}, \\ \sum_{n=0}^{\infty} (-1)^n \int_0^x t^{2n} dt &= \operatorname{arctg} t|_0^x, \end{aligned}$$

$$\sum_{n=0}^{\infty} (-1)^n \frac{x^{2n+1}}{2n+1} = \operatorname{arctg} x .$$

Keyingi tenglikda $x = 1$ deylik. U holda tenglikning chap tomoni

$$\sum_{n=0}^{\infty} \frac{(-1)^n}{2n+1}$$

sonli qatorga aylanib, u Leybnits teoremasiga ko'ra, yaqinlashuvchi bo'ladi. Demak,

$$\sum_{n=0}^{\infty} \frac{(-1)^n}{2n+1} = \operatorname{arctg} 1 = \frac{\pi}{4} . \blacktriangleright$$

Mashqlar

1. Hadlab differensiallash bilan ushbu

$$1 + \frac{x^2}{2!} + \frac{x^4}{4!} + \dots$$

darajali qatorning yig'indisi topilsin.

2. Hadlab integrallash bilan ushbu

$$x - 4x^2 + 9x^3 - 16x^4 + \dots$$

darajali qatorning yig'indisi topilsin.

70- ma'ruza

Taylor qatori

1°. **Funksiyaning Taylor qatori.** Aytaylik, $f(x)$ funksiya $x_0 \in R$ nuqtaning biror

$$U_{\delta}(x_0) = \{x \in R : x_0 - \delta < x < x_0 + \delta; \delta > 0\}$$

atrofida istalgan tartibdagi hosilaga ega bo'lsin. Bu hol $f(x)$ funksiyaning Taylor formulasini yozish imkonini beradi:

$$f(x) = f(x_0) + \frac{f'(x_0)}{1!}(x - x_0) + \frac{f''(x_0)}{2!}(x - x_0)^2 + \dots + \frac{f^{(n)}(x_0)}{n!}(x - x_0)^n + r_n(x),$$

bunda $r_n(x)$ — qoldiq had.

Modomiki, $f(x)$ funksiya $U_\delta(x_0)$ da istalgan tartibdagi hosilaga ega ekan, u holda

$$f(x_0) + \frac{f'(x_0)}{1!}(x-x_0) + \frac{f''(x_0)}{2!}(x-x_0)^2 + \dots + \frac{f^{(n)}(x_0)}{n!}(x-x_0)^n + \dots \quad (1)$$

darajali qatorni qarash mumkin bo'ladi.

(1) darajali qatorning koeffitsiyentlari sonlar bo'lib, ular $f(x)$ funksiya va uning hosilalarining x_0 nuqtadagi qiymatlari orqali ifodalangan.

(1) *darajali qator $f(x)$ funksiyaning Teylor qatori* deyiladi.

Xususan, $x_0 = 0$ bo'lganda (1) darajali qator ushbu

$$f(0) + \frac{f'(0)}{1!}x + \frac{f''(0)}{2!}x^2 + \dots + \frac{f^{(n)}(0)}{n!}x^n + \dots = \sum_{n=1}^{\infty} \frac{f^{(n)}(0)}{n!}x^n$$

ko'rinishga keladi. Faraz qilaylik, $f(x)$ funksiya biror $(-r, r)$ da ($r > 0$) istalgan tartibdagi hosilaga ega bo'lib, uning $x_0 = 0$ nuqtadagi Teylor qatori

$$f(0) + \frac{f'(0)}{1!}x + \frac{f''(0)}{2!}x^2 + \dots + \frac{f^{(n)}(0)}{n!}x^n + \dots \quad (2)$$

bo'lsin. Bu qatorning qoldiq hadini $r_n(x)$ deylik:

$$f(0) + \frac{f'(0)}{1!}x + \frac{f''(0)}{2!}x^2 + \dots + \frac{f^{(n)}(0)}{n!}x^n + r_n(x).$$

1- teorema. (2) darajali qator $(-r, r)$ da $f(x)$ ga yaqinlashishi uchun ushbu

$$f(x) = f(0) + \frac{f'(0)}{1!}x + \frac{f''(0)}{2!}x^2 + \dots + \frac{f^{(n)}(0)}{n!}x^n + r_n(x)$$

Teylor formulasida $\forall x \in (-r, r)$ uchun

$$\lim_{n \rightarrow \infty} r_n(x) = 0$$

bo'lishi zarur va yetarli.

◀ **Zarurligi.** Aytaylik, (2) darajali qator $(-r, r)$ da yaqinlashuvchi, yig'indisi $f(x)$ bo'lsin. Ta'rifga binoan

$$\lim_{n \rightarrow \infty} S_n(x) = f(x), \quad (x \in (-r, r))$$

bo'ladi, bunda

$$S_n(x) = f(0) + \frac{f'(0)}{1!}x + \frac{f''(0)}{2!}x^2 + \dots + \frac{f^{(n)}(0)}{n!}.$$

Ravshanki, $\forall x \in (-r, r)$ da $\lim_{n \rightarrow \infty} S_n(x) = f(x)$ bo'lishidan

$$\lim_{n \rightarrow \infty} [f(x) - S_n(x)] = \lim_{n \rightarrow \infty} r_n(x) = 0$$

bo'lishi kelib chiqadi.

Yetarlilik. Aytaylik, $\forall x \in (-r, r)$ da $\lim_{n \rightarrow \infty} r_n(x) = 0$ bo'lsin. U holda

$$\lim_{n \rightarrow \infty} [f(x) - S_n(x)] = \lim_{n \rightarrow \infty} r_n(x) = 0$$

bo'lib, undan

$$\lim_{n \rightarrow \infty} S_n(x) = f(x)$$

bo'lishi kelib chiqadi. Demak,

$$f(x) = f(0) + \frac{f'(0)}{1!}x + \frac{f''(0)}{2!}x^2 + \dots + \frac{f^{(n)}(0)}{n!} + \dots$$

bo'ladi. ►

Odatda, bu munosabat o'rinli bo'lsa, $f(x)$ funksiya Teylor qatoriga yoyilgan deyiladi.

2°. Funksiyani Teylor qatoriga yoyish. Faraz qilaylik, $f(x)$ funksiya biror $(-r, r)$ da istalgan tartibdagi hosilalarga ega bo'lsin.

2- teorema. Agar $\exists M > 0$, $\forall x \in (-r, r)$, $\forall n \geq 0$ da

$$|f^{(n)}(x)| \leq M$$

bo'lsa, $f(x)$ funksiya $(-r, r)$ da Teylor qatoriga yoyiladi:

$$f(x) = \sum_{n=0}^{\infty} \frac{f^{(n)}(0)}{n!} = f(0) + \frac{f'(0)}{1!}x + \frac{f''(0)}{2!}x^2 + \dots + \frac{f^{(n)}(0)}{n!}x^n + \dots \quad (3)$$

◄ Ma'lumki, $f(x)$ funksiyaning Lagranj ko'rinishidagi qoldiq hadli Teylor formulasi quyidagicha bo'ladi:

$$f(x) = f(0) + \frac{f'(0)}{1!}x + \frac{f''(0)}{2!}x^2 + \dots + \frac{f^{(n)}(0)}{n!}x^n + r_n(x),$$

bunda $r_n(x) = \frac{f^{(n)}(\theta x)}{(n+1)!}x^{n+1}$, $(0 < \theta < 1)$.

Teoremaning shartidan foydalanib topamiz:

$$|r_n(x)| = \left| \frac{f^{(n)}(\theta x)}{(n+1)!}x^{n+1} \right| \leq M \cdot \frac{r^{n+1}}{(n+1)!}, \quad (x \in (-r, r)).$$

Ravshanki, $\lim_{n \rightarrow \infty} \frac{r^{n+1}}{(n+1)!} = 0$.

Demak, $\forall x_0 \in (-r, r)$ da

$$\lim_{n \rightarrow \infty} r_n(x) = 0$$

bo'lib, undan qaralayotgan $f(x)$ funksiyaning Teylor qatoriga yoyilishi kelib chiqadi. ►

3°. Elementar funksiyalarni Teylor qatoriga yoyish.

a) Ko'rsatkichli va giperbolik funksiyalarning Teylor qatorlarini topamiz. Aytaylik,

$$f(x) = e^x$$

bo'lsin. Ravshanki, $f(0) = 1, f^{(n)}(0) = 1, (n \in N)$ bo'lib, $\forall x \in (-\alpha, \alpha)$ da ($\alpha > 0$)

$$0 < f(x) < e^\alpha, \quad 0 < f^{(n)}(x) < e^\alpha$$

bo'ladi. Binobarin, 2- teoreмага ko'ra $f(x) = e^x$ funksiya $(-\alpha, \alpha)$ da Teylor qatoriga yoyiladi va (3) formulada foydalanib topamiz:

$$e^x = \sum_{n=0}^{\infty} \frac{x^n}{n!} = 1 + \frac{x}{1!} + \frac{x^2}{2!} + \dots + \frac{x^n}{n!} + \dots, \quad (0! = 1). \quad (4)$$

$\alpha > 0$ ixtiyoriy musbat son. Demak, (4) darajali qatorning yaqinlashish radiusi $r = +\infty$ bo'ladi.

(4) munosabatda x ni $-x$ ga almashtirib topamiz:

$$e^{-x} = \sum_{n=0}^{\infty} \frac{(-x)^n}{n!} = 1 - \frac{x}{1!} + \frac{x^2}{2!} - \dots + (-1)^n \cdot \frac{x^n}{n!} + \dots$$

Ma'lumki, giperbolik sinus hamda giperbolik kosinus funksiyalari quyidagicha ta'riflanar edi:

$$\text{sh } x = \frac{e^x - e^{-x}}{2}, \quad \text{ch } x = \frac{e^x + e^{-x}}{2}.$$

Yuqoridagi

$$e^x = 1 + \frac{x}{1!} + \frac{x^2}{2!} + \dots + \frac{x^n}{n!} + \dots,$$
$$e^{-x} = 1 - \frac{x}{1!} + \frac{x^2}{2!} - \dots + (-1)^n \frac{x^n}{n!} + \dots$$

formulalardan foydalanib topamiz:

$$\begin{aligned} \operatorname{sh} x &= \frac{x}{1!} + \frac{x^3}{3!} + \dots + \frac{x^{2n+1}}{(2n+1)!} + \dots = \sum_{n=0}^{\infty} \frac{x^{2n+1}}{(2n+1)!} \\ \operatorname{ch} x &= 1 + \frac{x^2}{2!} + \frac{x^4}{4!} + \dots + \frac{x^{2n}}{(2n)!} + \dots = \sum_{n=0}^{\infty} \frac{x^{2n}}{(2n)!} \end{aligned}$$

Bu $\operatorname{sh} x$, $\operatorname{ch} x$ funksiyalarining Teylor qatorlari bo'lib, ular ifodalangan darajali qatorlarning yaqinlashish radiuslari $r = +\infty$ bo'ladi.

b) Trigonometrik funksiyalarning Teylor qatorlarini topamiz. Aytaylik, $f(x) = \sin x$ bo'lsin. Ravshanki, $\forall x \in R$, $\forall n \in N$ da

$$|f(x)| \leq 1, \quad |f^{(n)}(x)| \leq 1$$

bo'lib. $f(0) = 0$, $f'(0) = 1$, $f^{(2n)}(0) = 0$, $f^{(2n+1)}(0) = (-1)^n$, ($n \in N$) bo'ladi. Demak, 2- teoremaga ko'ra $f(x) = \sin x$ funksiya Teylor qatoriga yoyiladi va (3) formulaga binoan

$$\sin x = \sum_{n=0}^{\infty} \frac{(-1)^n}{(2n+1)!} x^{2n+1} = x - \frac{1}{3!} x^3 + \frac{1}{5!} x^5 - \dots \quad (5)$$

bo'ladi. Aytaylik,

$$f(x) = \cos x$$

bo'lsin. Bu funksiya uchun $\forall x \in R$, $\forall n \in N$ da

$$|f(x)| \leq 1, \quad |f^{(n)}(x)| \leq 1$$

bo'lib,

$$f(0) = 1, \quad f'(0) = 0, \quad f^{(2n)}(0) = (-1)^n, \quad f^{(2n+1)}(0) = 0, \quad (n \in N)$$

bo'ladi. U holda 2- teoremaga ko'ra $f(x) = \cos x$ funksiya Teylor qatoriga yoyiladi va (3) formulaga binoan

$$\cos x = \sum_{n=0}^{\infty} \frac{(-1)^n}{(2n)!} x^{2n} = 1 - \frac{1}{2!} x^2 + \frac{1}{4!} x^4 - \dots \quad (6)$$

bo'ladi.

(5) va (6) darajali qatorlarning yaqinlashish radiusi $r = +\infty$ bo'ladi.

d) Logarifmik funksiyaning Teylor qatorini topamiz. Aytaylik,

$$f(x) = \ln(1+x)$$

bo'lsin. Ma'lumki,

$$f^{(n)}(x) = \frac{(-1)^{n-1}(n-1)!}{(1+x)^n}, \quad (n \in N)$$

bo'lib,

$$\frac{f^{(n)}(0)}{n!} = \frac{(-1)^{n-1}}{n}$$

bo'ladi. Bu funksiyaning Teylor formulasi

$$\ln(1+x) = x - \frac{x^2}{2} + \frac{x^3}{3} - \frac{x^4}{4} + \dots + (-1)^{n-1} \frac{x^n}{n} + r_n(x) \quad (7)$$

ko'rinishga ega.

$f(x) = \ln(1+x)$ funksiyaning Teylor qatoriga yoyishda 1- teorema-dan foydalanamiz. Buning uchun (7) formulada $r_n(x)$ ning 0 ga intilishini ko'rsatish yetarli bo'ladi.

Aytaylik, $x \in [0, 1]$ bo'lsin. Bu holda Lagranj ko'rinishida yozilgan

$$r_n(x) = \frac{(-1)^n x^{n+1}}{(n+1)(1+\theta x)^{n+1}}, \quad (0 < \theta < 1)$$

qoldiq had uchun $|r_n(x)| \leq \frac{1}{n+1}$

bo'ladi va $\lim_{n \rightarrow \infty} r_n(x) = 0$

tenglik bajariladi. Aytaylik, $x \in [-\alpha, 0]$ bo'lsin ($0 < \alpha < 1$). Bu holda Koshi ko'rinishida yozilgan

$$r_n(x) = \frac{(-1)^n (1-\theta_1)^n x^{n+1}}{(1+\theta_1 x)^{n+1}}, \quad (0 < \theta_1 < 1)$$

qoldiq had uchun

$$|r_n(x)| \leq \frac{\alpha^{n+1}}{1-\alpha}$$

bo'lib, quyidagiga ega bo'lamiz:

$$\lim_{n \rightarrow \infty} r_n(x) = 0.$$

Demak, $\forall x \in (-1, 1]$

$$\lim_{n \rightarrow \infty} r_n(x) = 0.$$

U holda 1- teoremaga ko'ra

$$\ln(1+x) = \sum_{n=1}^{\infty} \frac{(-1)^{n-1}}{n} x^n = x - \frac{x^2}{2} + \frac{x^3}{3} - \dots + (-1)^{n-1} \frac{x^n}{n} + \dots \quad (8)$$

bo'ladi.

(8) darajali qatorning yaqinlashish radiusi $r = 1$ ga teng. Agar yuqoridagi $\ln(1+x)$ ning yoyilmasida x ni $-x$ ga almashtirilsa, u holda

$$\ln(1-x) = -\sum_{n=1}^{\infty} \frac{x^n}{n} = -x - \frac{x^2}{2} - \frac{x^3}{3} - \dots - \frac{x^n}{n} - \dots$$

formula kelib chiqadi.

e) Darajali funksiyaning Teylor qatorini topamiz.

Aytaylik,

$$f(x) = (1+x)^\alpha, \quad (\alpha \in R)$$

bo'lsin. Ma'lumki,

$$f^{(n)}(x) = \alpha(\alpha-1)(\alpha-2)\dots(\alpha-n+1)(1+x)^{\alpha-n}$$

bo'lib,

$$f^{(n)}(0) = \alpha(\alpha-1)(\alpha-2)\dots(\alpha-n+1)$$

bo'ladi. Bu funksiyaning Teylor formulasi ushbu

$$(1+x)^\alpha = 1 + \frac{\alpha}{1!}x + \frac{\alpha(\alpha-1)}{2!}x^2 + \dots + \frac{\alpha(\alpha-1)\dots(\alpha-n+1)}{n!}x^n + r_n(x)$$

ko'rinishga ega.

Endi $n \rightarrow \infty$ da $r_n(x) \rightarrow 0$ bo'lishini ko'rsatamiz.

Ma'lumki, Teylor formulasidagi qoldiq hadning Koschi ko'rinishi quyidagicha

$$r_n(x) = \frac{(\alpha-1)(\alpha-2)\dots[(\alpha-1)-(n-1)]}{n!} x^n \alpha \cdot x (1+\theta x)^{\alpha-1} \left(\frac{1-\theta}{1+\theta x}\right)^n,$$

($0 < \theta < 1$) bo'lar edi. Aytaylik, $x \in (-1, 1)$ bo'lsin. Bu holda:

$$1) \lim_{n \rightarrow \infty} \frac{1}{n!} (\alpha-1)(\alpha-2)\dots[(\alpha-1)-(n-1)] x^n = 0 \text{ bo'ladi,}$$

chunki limit ishorasi ostidagi ifoda yaqinlashuvchi ushbu

$$1 + \sum_{n=1}^{\infty} \frac{\alpha(\alpha-1)\dots(\alpha-n+1)}{n!} x^n$$

qatorning umumiy hadi;

$$2) |\alpha \cdot x| (1 - |x|)^{\alpha-1} < \alpha \cdot x (1 + \theta x)^{\alpha-1} < |\alpha \cdot x| (1 + |x|)^{\alpha-1};$$

$$3) \left| \frac{1-\theta}{1+\theta x} \right|^n \leq \left| \frac{1-\theta}{1+\theta x} \right| < 1 \text{ bo'ladi. Bu munosabatlardan foydalanib,}$$

$\forall x \in (-1, 1)$ da

$$\lim_{n \rightarrow \infty} r_n(x) = 0$$

bo'lishini topamiz. 1- teoreмага ko'ra

$$(1+x)^\alpha = 1 + \frac{\alpha}{1!} x + \frac{\alpha(\alpha-1)}{2!} x^2 + \dots + \frac{\alpha(\alpha-1)\dots(\alpha-n+1)}{n!} x^n + \dots \quad (9)$$

bo'ladi. Bu darajali qatorning yaqinlashish radiusi $\alpha \neq 0$, $\alpha \in \mathbb{N}$ bo'lganda 1 ga teng: $r = 1$.

(9) munosabatda $\alpha = -1$ deb olinsa, u holda ushbu

$$\frac{1}{1+x} = \sum_{n=0}^{\infty} (-1)^n x^n = 1 - x + x^2 - x^3 + x^4 - \dots + (-1)^n x^n + \dots$$

formula hosil bo'ladi. Bu formulada x ni $-x$ ga almashtirib topamiz:

$$\frac{1}{1-x} = \sum_{n=0}^{\infty} (-1)^n x^n = 1 + x + x^2 + \dots + x^n + \dots$$

1- misol. Ushbu $f(x) = \ln \frac{1+x}{1-x}$ funksiya Teylor qatoriga yoyilsin.

◀ Ma'lumki, $\ln \frac{1+x}{1-x} = \ln(1+x) - \ln(1-x)$ bo'ladi.

Biz yuqorida

$$\ln(1+x) = x - \frac{x^2}{2} + \frac{x^3}{3} - \dots + (-1)^{n-1} \frac{x^n}{n} + \dots,$$

$$\ln(1-x) = -x - \frac{x^2}{2} - \frac{x^3}{3} - \dots - \frac{x^n}{n} - \dots$$

bo'lishini ko'rgan edik. Bu munosabatlardan foydalanib topamiz:

$$\ln(1+x) - \ln(1-x) = x - \frac{x^2}{2} + \frac{x^3}{3} - \dots + (-1)^{n-1} \frac{x^n}{n} + \dots$$

$$-\left(-x - \frac{x^2}{2} - \frac{x^3}{3} - \dots - \frac{x^n}{n} - \dots\right) = 2x + \frac{2x^3}{3} + \frac{2x^5}{5} + \dots + \frac{2x^{2n-1}}{2n-1} + \dots$$

Demak,
$$\ln \frac{1+x}{1-x} = 2 \left(x + \frac{x^3}{3} + \frac{x^5}{5} + \dots + \frac{x^{2n-1}}{2n-1} + \dots \right). \quad (10)$$

(10) darajali qatorning yaqinlashish radiusi $r = 1$ bo'lib, yaqinlashish to'plami $(-1, 1)$ bo'ladi. ►

2- misol. Ushbu $f(x) = \int_0^x \frac{\sin t}{t} dt$ funksiya Teylor qatoriga yoyilsin.

◀ Ma'lumki,
$$\sin t = t - \frac{t^3}{3!} + \frac{t^5}{5!} - \dots + (-1)^{n-1} \frac{t^{2n-1}}{(2n-1)!} + \dots$$

U holda
$$\frac{\sin t}{t} = 1 - \frac{t^2}{3!} + \frac{t^4}{5!} - \dots + (-1)^{n-1} \frac{t^{2n-2}}{(2n-1)!} + \dots$$
 bo'ladi.

Bu darajali qatorni hadlab integrallab topamiz:

$$\int_0^x \frac{\sin t}{t} dt = \int_0^x \left(1 - \frac{t^2}{3!} + \frac{t^4}{5!} - \dots + (-1)^{n-1} \frac{t^{2n-2}}{(2n-1)!} + \dots \right) dt =$$

$$= x - \frac{x^3}{3! \cdot 3} + \frac{x^5}{5! \cdot 5} - \dots + (-1)^{n-1} \frac{x^{2n-1}}{(2n-1)! (2n-1)} + \dots$$

Keyingi darajali qatorning yaqinlashish radiusi $r = +\infty$ bo'ladi. ►

3- misol. Ushbu $f(x) = \frac{2x-1}{x^2+x-6}$ funksiya Teylor qatoriga yoyilsin

va bu qatorning yaqinlashish radiusi topilsin.

◀ Avvalo $f(x)$ funksiyani quyidagicha yozib olamiz:

$$f(x) = \frac{2x-1}{x^2+x-6} = \frac{1}{x+2} + \frac{1}{x-3} = \frac{1}{2\left(1+\frac{1}{2}x\right)} - \frac{1}{3\left(1-\frac{1}{3}x\right)}.$$

Ma'lumki,
$$\frac{1}{1+x} = \sum_{n=0}^{\infty} (-1)^n \cdot x^n, \quad \frac{1}{1-x} = \sum_{n=0}^{\infty} x^n.$$

Bu formulardan foydalanib topamiz:

$$\frac{1}{2\left(1+\frac{1}{2}x\right)} = \sum_{n=0}^{\infty} \frac{1}{2} (-1)^n \cdot \left(\frac{1}{2}x\right)^n = \sum_{n=0}^{\infty} \frac{(-1)^n}{2^{n+1}} x^n, \quad (r=2),$$

$$\frac{1}{3\left(1-\frac{1}{3}x\right)} = \sum_{n=0}^{\infty} \frac{1}{3} \left(\frac{1}{3}x\right)^n = \sum_{n=0}^{\infty} \frac{1}{3^{n+1}} x^n, \quad (r=3).$$

Demak, quyidagi Teylor qatorini olamiz:

$$\frac{2x-1}{x^2+x-6} = \sum_{n=0}^{\infty} \frac{(-1)^n}{2^{n+1}} x^n - \sum_{n=0}^{\infty} \frac{1}{3^{n+1}} x^n = \sum_{n=0}^{\infty} \left(\frac{(-1)^n}{2^{n+1}} - \frac{1}{3^{n+1}} \right) x^n.$$

Bu darajali qatorning yaqinlashish radiusi $r=2$ bo'ladi. ►

Mashqlar

1. Ushbu $f(x) = \sin^3 x$, $f(x) = \ln(1-x^2)$, $f(x) = \frac{1}{1+x+x^2}$

funksiyalar Teylor qatoriga yoyilsin.

2. Ushbu $\sum_{n=0}^{\infty} \frac{x^{3n}}{(3n)!}$, ($x \in R$) qatorning yig'indisi topilsin.

71- ma'ruza

Uzluksiz funksiyani ko'phad bilan yaqinlashtirish. Veyershtrass teoremasi

1°. **Bernshteyn ko'phadi.** Aytaylik, $f(x)$ funksiya $[0,1]$ segmentda berilgan bo'lsin. Ushbu

$$\sum_{k=0}^n f\left(\frac{k}{n}\right) C_n^k x^k (1-x)^{n-k} = f(0) \cdot (1-x)^n + f\left(\frac{1}{n}\right) C_n^1 x (1-x)^{n-1} + \dots + f(1) x^n$$

ko'phad $f(x)$ funksiyaning Bernshteyn ko'phadi deyiladi va $B_n(f; x)$ kabi belgilanadi:

$$B_n(f; x) = \sum_{k=0}^n f\left(\frac{k}{n}\right) C_n^k x^k (1-x)^{n-k}.$$

$$\text{Bunda } C_n^k = \frac{n(n-1)(n-2) \dots (n-k+1)}{k!}.$$

Demak, Bernshteyn ko'phadi n - darajali ko'phad bo'lib, uning koeffitsiyentlari $f(x)$ funksiyaning

$$\frac{k}{n}, \quad (k = 0, 1, 2, \dots, n)$$

nuqtalardagi qiymatlari orqali ifodalanadi. Masalan,

$$B_1(f; x) = f(0) + [f(1) - f(0)]x,$$

$$B_2(f; x) = f(0) + \left[2f\left(\frac{1}{2}\right) - 2f(0)\right]x + \left[f(0) + 2f\left(\frac{1}{2}\right) + f(1)\right]x^2$$

bo'ladi.

2°. Muhim lemma. Ushbu

$$\sum_{k=0}^n C_n^k x^k (1-x)^{n-k} = 1, \quad (1)$$

$$\sum_{k=0}^n \left(\frac{k}{n} - x\right)^2 C_n^k x^k (1-x)^{n-k} = \frac{x(1-x)}{n}, \quad (0 \leq x \leq 1) \quad (2)$$

ayniyatlar o'rinli.

◀ Nyuton binomi formulasi

$$\sum_{k=0}^n C_n^k a^k b^{n-k} = (a+b)^n$$

da $a = x$, $b = 1 - x$ deyilsa, u holda

$$\sum_{k=0}^n C_n^k x^k (1-x)^{n-k} = 1$$

bo'lishi kelib chiqadi.

(2) ayniyatni isbotlash uchun quyidagi

$$\sum_{k=0}^n \frac{k}{n} C_n^k x^k (1-x)^{n-k}, \quad \sum_{k=0}^n \frac{k^2}{n^2} C_n^k x^k (1-x)^{n-k}$$

yig'indilarni hisoblaymiz.

Bu yig'indini hisoblashda yuqorida keltirilgan C_n^k ning ifodasi va Nyuton binomi formulasidan foydalanamiz:

$$\begin{aligned} \sum_{k=0}^n \frac{k}{n} C_n^k x^k (1-x)^{n-k} &= \sum_{k=1}^n \frac{k}{n} C_n^k x^k (1-x)^{n-k} = \sum_{k=1}^n C_{n-1}^{k-1} x^k (1-x)^{n-k} = \\ &= x \cdot \sum_{k=1}^n C_{n-1}^{k-1} x^{k-1} (1-x)^{n-1-(k-1)} = x [x + (1-x)]^{n-1} = x. \end{aligned}$$

Demak,
$$\sum_{k=0}^n \frac{k}{n} C_n^k x^k (1-x)^{n-k} = x. \quad (3)$$

Endi
$$\sum_{k=0}^n \frac{k^2}{n^2} C_n^k x^k (1-x)^{n-k}$$

yig'indini hisoblaymiz:

$$\begin{aligned} \sum_{k=0}^n \frac{k^2}{n^2} C_n^k x^k (1-x)^{n-k} &= \sum_{k=1}^n \frac{k}{n} C_{n-1}^{k-1} x^k (1-x)^{n-k} = \\ &= \sum_{k=1}^n \frac{n-1}{n} \cdot \frac{k-1}{n-1} C_{n-1}^{k-1} x^k (1-x)^{n-k} + \sum_{k=1}^n \frac{1}{n} C_{n-1}^{k-1} x^k (1-x)^{n-k} = \\ &= \frac{n-1}{n} x^2 \sum_{k=2}^n C_{n-2}^{k-2} x^{k-2} (1-x)^{n-2-(k-2)} + \frac{1}{n} x \sum_{k=1}^n C_{n-1}^{k-1} x^{k-1} (1-x)^{n-1-(k-1)} = \\ &= \frac{n-1}{n} x^2 [x + (1-x)]^{n-2} + \frac{1}{n} x [x + (1-x)]^{n-1} = x^2 + \frac{x(1-x)}{n}. \end{aligned}$$

Demak,
$$\sum_{k=0}^n \frac{k^2}{n^2} C_n^k x^k (1-x)^{n-k} = x^2 + \frac{x(1-x)}{n}. \quad (4)$$

Yuqoridagi (1), (3) va (4) munosabatlardan foydalanib topamiz:

$$\begin{aligned} \sum_{k=0}^n \left(\frac{k}{n} - x \right)^2 C_n^k x^k (1-x)^{n-k} &= \sum_{k=0}^n \frac{k^2}{n^2} C_n^k x^k (1-x)^{n-k} - \\ &- 2x \sum_{k=0}^n \frac{k}{n} C_n^k x^k (1-x)^{n-k} + x^2 \sum_{k=0}^n C_n^k x^k (1-x)^{n-k} = \\ &= x^2 + \frac{x(1-x)}{n} - 2x \cdot x + x^2 = \frac{x(1-x)}{n}. \blacktriangleright \end{aligned}$$

Natija. $\forall x \in [0, 1], \forall n \in N$ uchun

$$\sum_{k=0}^n \left(\frac{k}{n} - x\right)^2 C_n^k x^k (1-x)^{n-k} \leq \frac{1}{4n} \quad (5)$$

tengsizlik o'rinli bo'ladi.

◀ Ravshanki, $\forall x \in [0, 1]$ uchun

$$x(1-x) \leq \frac{1}{4}$$

bo'ladi. Bu tengsizlik va (2) munosabatdan (5) tengsizlikning o'rinli bo'lishi kelib chiqadi. ▶

3°. Uzlüksiz funksiyani ko'phad bilan yaqinlashtirish.

1- teorema. (Bernshteyn teoremasi.) Agar $f(x)$ funksiya $[0, 1]$ segmentda uzlüksiz bo'lsa, u holda

$$\lim_{n \rightarrow \infty} \max_{0 \leq x \leq 1} |f(x) - B_n(f, x)| = 0$$

bo'ladi, bunda

$$B_n(f; x) = \sum_{k=0}^n f\left(\frac{k}{n}\right) C_n^k x^k (1-x)^{n-k}. \quad (6)$$

◀ (1) va (6) munosabatlardan foydalanib topamiz:

$$B_n(f; x) - f(x) = \sum_{k=0}^n \left[f\left(\frac{k}{n}\right) - f(x) \right] C_n^k x^k (1-x)^{n-k}.$$

Kantor teoremasiga ko'ra qaralayotgan $f(x)$ funksiya $[0, 1]$ da tekis uzlüksiz bo'ladi. U holda ta'rifga binoan

$$\forall \varepsilon > 0, \exists \delta > 0, \forall x', x'' \in [0, 1] \text{ uchun } |x' - x''| < \delta$$

bo'lganda $|f(x'') - f(x')| < \frac{\varepsilon}{2}$

tengsizlik bajariladi. Ma'lumki,

$$B_n(f; x) - f(x)$$

ayirmani ifodalovchi yig'indida $n+1$ ta had bo'lib, ular k ning $0, 1, 2, \dots, n$ qiymatlarida yuzaga keladi. Bu k ning ushbu

$$\left| \frac{k}{n} - x \right| < \delta, \quad (x \in [0, 1])$$

tengsizlikni qanoatlantiradigan qiymatlari to'plamini $E_n(k)$ bilan;

$$\left| \frac{k}{n} - x \right| \geq \delta, \quad (x \in [0, 1])$$

tengsizlikni qanoatlantiradigan qiymatlari to'plamini $F_n(k)$ bilan belgilaylik. Ravshanki,

$$E_n(k) \cup F_n(k) = \{0, 1, 2, \dots, n\}$$

bo'ladi. Shuni e'tiborga olib, yuqoridagi yig'indini ikki qismga ajratamiz:

$$\begin{aligned} \sum_{k=0}^n \left[f\left(\frac{k}{n}\right) - f(x) \right] C_n^k x^k (1-x)^{n-k} &= \sum_{E_n(k)} \left[f\left(\frac{k}{n}\right) - f(x) \right] C_n^k x^k (1-x)^{n-k} + \\ &+ \sum_{F_n(k)} \left[f\left(\frac{k}{n}\right) - f(x) \right] C_n^k x^k (1-x)^{n-k}. \end{aligned}$$

Endi bu yig'indilarni baholaymiz. $f(x)$ funksiyaning $[0, 1]$ da tekis uzluksizligidan hamda lemmadan foydalanib topamiz:

$$\begin{aligned} \left| \sum_{E_n(k)} \left[f\left(\frac{k}{n}\right) - f(x) \right] C_n^k x^k (1-x)^{n-k} \right| &\leq \sum_{E_n(k)} \left| f\left(\frac{k}{n}\right) - f(x) \right| C_n^k x^k (1-x)^{n-k} = \\ &= \sum_{k: \left| \frac{k}{n} - x \right| < \delta} \left| f\left(\frac{k}{n}\right) - f(x) \right| C_n^k x^k (1-x)^{n-k} < \frac{\varepsilon}{2} \sum_{E_n(k)} C_n^k x^k (1-x)^{n-k} \leq \\ &\leq \frac{\varepsilon}{2} \sum_{k=0}^n C_n^k x^k (1-x)^{n-k} = \frac{\varepsilon}{2}. \end{aligned}$$

Ravshanki, $f(x)$ funksiya $[0, 1]$ da chegaralangan. U holda $\max_{0 \leq x \leq 1} |f(x)| = M \in R$ bo'ladi. Shuni e'tiborga olib topamiz:

$$\begin{aligned} \left| \sum_{F_n(k)} \left[f\left(\frac{k}{n}\right) - f(x) \right] C_n^k x^k (1-x)^{n-k} \right| &\leq \\ &\leq \sum_{k: \left| \frac{k}{n} - x \right| \geq \delta} \left| f\left(\frac{k}{n}\right) - f(x) \right| C_n^k x^k (1-x)^{n-k} \leq \\ &\leq 2M \sum_{k: \left| \frac{k}{n} - x \right| \geq \delta} C_n^k x^k (1-x)^{n-k}. \end{aligned}$$

Agar $\left| \frac{k}{n} - x \right| \geq \delta \Rightarrow \left(\frac{k}{n} - x \right)^2 \cdot \frac{1}{\delta^2} \geq 1$

bo'lishini hisobga olsak, u holda lemmaga ko'ra

$$\begin{aligned} \sum_{k \left| \frac{k}{n} - x \right| \geq \delta} C_n^k x^k (1-x)^{n-k} &\leq \frac{1}{\delta^2} \sum_{k \left| \frac{k}{n} - x \right| \geq \delta} \left(\frac{k}{n} - x \right)^2 C_n^k x^k (1-x)^{n-k} \leq \\ &\leq \frac{1}{\delta^2} \sum_{k=0}^n \left(\frac{k}{n} - x \right)^2 C_n^k x^k (1-x)^{n-k} \leq \frac{1}{4n\delta^2} \end{aligned}$$

bo'ladi. Shunday qilib,

$$\begin{aligned} |B_n(f; x) - f(x)| &\leq \left| \sum_{E_n(k)} \left[f\left(\frac{k}{n}\right) - f(x) \right] C_n^k x^k (1-x)^{n-k} \right| + \\ &+ \left| \sum_{F_n(k)} \left[f\left(\frac{k}{n}\right) - f(x) \right] C_n^k x^k (1-x)^{n-k} \right| < \frac{\varepsilon}{2} + \frac{M}{2n\delta^2} \end{aligned}$$

bo'ladi. Agar $n > \frac{M}{2\delta^2\varepsilon}$ deyilsa, u holda

$$\frac{M}{2\delta^2 n} < \frac{1}{2} \varepsilon$$

bo'lib, natijada quyidagiga ega bo'lamiz:

$$|B_n(f; x) - f(x)| < \varepsilon$$

Bu munosabatdan esa

$$\lim_{n \rightarrow \infty} \max_{0 \leq x \leq 1} |B_n(f; x) - f(x)| = 0$$

bo'lishi kelib chiqadi. ►

Bu teoremdan $n \rightarrow \infty$ da

$$B_n(f; x) \rightarrow f(x), \quad (0 \leq x \leq 1)$$

bo'lishini topamiz. Demak, $[0, 1]$ da uzluksiz bo'lgan $f(x)$ funksiya $B_n(f; x)$ ko'phad bilan yaqinlashtirildi:

$$f(x) \approx \sum_{k=0}^n f\left(\frac{k}{n}\right) C_n^k x^k (1-x)^{n-k}, \quad (0 \leq x \leq 1).$$

Aytaylik, $f(x)$ funksiya $[a, b]$ segmentda uzluksiz bo'lsin. Ma'lumki, ushbu

$$t = \frac{1}{b-a} x - \frac{a}{b-a}$$

chiziqli almashtirish $[a, b]$ segmentni $[0, 1]$ segmentga almashtiradi. Bu almashtirishdan foydalanib ushbu

$$\varphi(t) = f(a + (b-a)t), \quad (0 \leq t \leq 1) \quad (7)$$

funksiyani hosil qilamiz. Ravshanki, $\varphi(t)$ funksiya $[0, 1]$ da uzluksiz bo'ladi. Yuqoridagi teoremadan foydalanib topamiz:

$$\lim_{n \rightarrow \infty} \max_{0 \leq t \leq 1} |B_n(\varphi; t) - \varphi(t)| = 0, \quad (8)$$

bunda

$$B_n(\varphi; t) = \sum_{k=0}^n \varphi\left(\frac{k}{n}\right) C_n^k t^k (1-t)^{n-k}.$$

(7) va (8) munosabatlardan

$$\lim_{n \rightarrow \infty} \max_{a \leq x \leq b} \left| B_n\left(f; \frac{x-a}{b-a}\right) - f(x) \right| = 0$$

bo'lishi kelib chiqadi, bunda

$$\begin{aligned} B_n\left(f; \frac{x-a}{b-a}\right) &= \sum_{k=0}^n f\left(a + \frac{b-a}{n} k\right) C_n^k \left(\frac{x-a}{b-a}\right)^k \left(1 - \frac{x-a}{b-a}\right)^{n-k} = \\ &= \sum_{k=0}^n f\left(a + \frac{b-a}{n} k\right) C_n^k \frac{(x-a)^k (b-x)^{n-k}}{(b-a)^n}. \end{aligned}$$

Shunday qilib quyidagi teoreмага kelamiz.

2- teorema (Veyershtross teoremasi.) Agar $f(x)$ funksiya $[a, b]$ segmentda uzluksiz bo'lsa,

$$\lim_{n \rightarrow \infty} \max_{a \leq x \leq b} \left| B_n\left(f; \frac{x-a}{b-a}\right) - f(x) \right| = 0$$

bo'ladi.

Mashqlar

1. Agar $f(x)$ funksiya $[0, 1]$ segmentda uzluksiz bo'lsa, $\forall x \in [0; 1]$ da

$$\lim_{n \rightarrow \infty} \sum_{k=0}^n (-1)^k f\left(\frac{k}{n}\right) C_n^k x^k (1-x)^{n-k} = 0$$

bo'lishi isbotlansin.

2. Agar $f(x)$ funksiya $[0, 1]$ segmentda uzluksiz bo'lsa,

$$\sup_{0 \leq x \leq 1} |B_n(f; x) - f(x)| \leq \frac{3}{2} \omega\left(\frac{1}{\sqrt{n}}\right)$$

bo'lishi isbotlansin, bunda $\omega(\delta)$ – funksiya $f(x)$ ning uzluksiz moduli.

72- ma'ruza

Furye qatori tushunchasi

1°. **Davriy funksiyalar haqida ba'zi ma'lumotlar.** $f(x)$ funksiya $R = (-\infty, +\infty)$ to'plamda berilgan bo'lsin. Ma'lumki, shunday $T \in R \setminus \{0\}$ son topilsaki, $\forall x \in R$ da

$$f(x + T) = f(x)$$

tenglik bajarilsa, $f(x)$ – davriy funksiya, $T \neq 0$ son esa uning davri deyilar edi.

Agar $f(x)$ davriy funksiya bo'lib, $T \neq 0$ son uning davri bo'lsa, kT sonlar ($k = \pm 1, \pm 2, \dots$) ham shu funksiyaning davri bo'ladi.

Agar $f(x)$ va $g(x)$ davriy funksiyalar bo'lib, $T \neq 0$ ularning davri bo'lsa,

$$f(x) \pm g(x), \quad f(x) \cdot g(x), \quad \frac{f(x)}{g(x)}, \quad (g(x) \neq 0)$$

funksiyalar ham davriy bo'lib, ularning davri T ga teng bo'ladi.

Aytaylik, $f(x)$ davriy funksiya bo'lib, uning davri T bo'lsin. Agar bu funksiya grafigining tasviri $[a, a+T]$ oraliqda ($a \in R$) ma'lum bo'lsa, uni birin-ketin

$$x = a + kT, \quad (k = \pm 1, \pm 2, \dots)$$

vertikal to'g'ri chiziqqa nisbatan simmetrik ko'chirish natijasida $f(x)$ ning $(-\infty, +\infty)$ dagi grafigi hosil bo'ladi (30- chizma).

Bu jarayonni $[a, a+T]$ da berilgan funksiyaning $(-\infty, +\infty)$ da davriy davom ettirish deb ham yuritiladi.

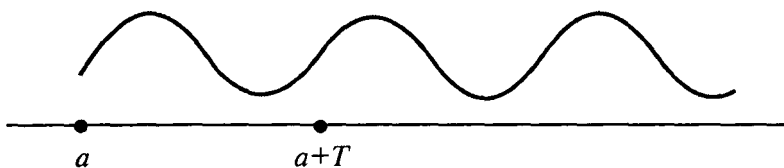

30- chizma.

Shuni ta'kidlash lozimki, T davrli $f(x)$ funksiya $[a, a+T]$ da uzluksiz bo'lsa, uni $(-\infty, +\infty)$ ga davriy davom ettirishdan hosil bo'lgan funksiya (uni ham $f(x)$ deymiz) $(-\infty, +\infty)$ da uzluksiz yoki bo'lakli uzluksiz (ya'ni $x = a + kT$ nuqtalarda ($k = \pm 1, \pm 2, \dots$) uzilishga ega bo'lib, boshqa barcha nuqtalarda uzluksiz) bo'lishi mumkin.

Masalan, $[0, 1]$ da berilgan

$$f(x) = 2\sqrt{x(1-x)}$$

funksiyani $(-\infty, +\infty)$ da davriy davom ettirishdan hosil bo'lgan funksiya $(-\infty, +\infty)$ da uzluksiz bo'ladi (31- chizma).

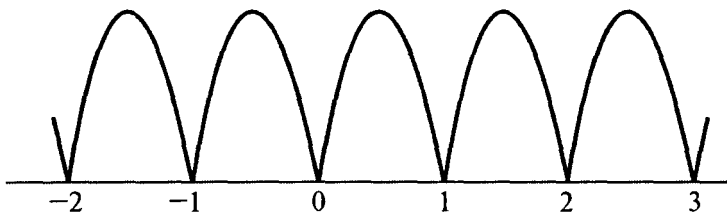

31- chizma.

$[-1, 2]$ da berilgan

$$f(x) = x^2$$

funksiyani $(-\infty, +\infty)$ da davriy davom ettirishdan hosil bo'lgan funksiya $(-\infty, +\infty)$ da bo'lakli uzluksiz bo'ladi (32- chizma):

Lemma. Agar $f(x)$ — davriy funksiya, uning davri T bo'lib, $[a, a+T]$ da integrallanuvchi bo'lsa, u holda

$$\int_a^{a+T} f(x) dx = \int_b^{b+T} f(x) dx, \quad (b \in \mathbb{R})$$

bo'ladi.

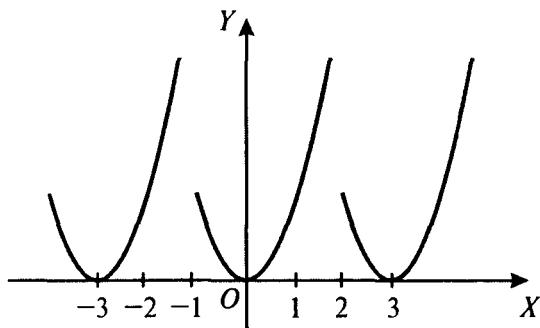

32- chizma.

◀ Aniq integral xossasidan foydalanib topamiz:

$$\int_a^{a+T} f(x) dx = \int_a^b f(x) dx + \int_b^{b+T} f(x) dx + \int_{b+T}^{a+T} f(x) dx. \quad (1)$$

Bu tenglikdagi $\int_{b+T}^{a+T} f(x) dx$

integralda $x = t + T$ almashtirish bajaramiz. Natijada

$$\int_{b+T}^{a+T} f(x) dx = \int_a^b f(t+T) dt = \int_a^b f(t) dt = - \int_a^b f(x) dx \quad (2)$$

bo'ladi. (1) va (2) munosabatlardan

$$\int_a^{a+T} f(x) dx = \int_b^{b+T} f(x) dx$$

bo'lishi kelib chiqadi. ▶

2°. Garmonikalar. Ushbu

$$f(x) = A \sin(\alpha x + \beta) \quad (3)$$

funksiyani qaraylik, bunda A , α , β — haqiqiy sonlar. Bu davriy funksiya bo'lib, uning davri

$$T = \frac{2\pi}{\alpha}, \quad (\alpha \neq 0)$$

ga teng bo'ladi.

◀ Haqiqatan ham,

$$\begin{aligned} f\left(x + \frac{2\pi}{\alpha}\right) &= A \sin\left(\alpha\left(x + \frac{2\pi}{\alpha}\right) + \beta\right) = A \sin(\alpha x + \beta + 2\pi) = \\ &= A \sin(\alpha x + \beta) = f(x). \quad \blacktriangleright \end{aligned}$$

Odatda, (3) funksiya *garmonika* deyiladi. Garmonikaning grafigi $y = \sin x$ funksiya grafigini OX va OY o'qlar bo'yicha siqish (cho'zish) hamda OX o'q bo'yicha surish natijasida hosil bo'ladi.

Garmonikani quyidagicha yozish ham mumkin:

$$\begin{aligned} f(x) &= A \sin(\alpha x + \beta) = A(\cos \alpha x \sin \beta + \sin \alpha x \cos \beta) = \\ &= A \sin \beta \cdot \cos \alpha x + A \cos \beta \cdot \sin \alpha x = a \cos \alpha x + b \sin \alpha x, \end{aligned}$$

bunda

$$a = A \sin \beta, \quad b = A \cos \beta.$$

Aksincha,

$$f(x) = a \cos \alpha x + b \sin \alpha x$$

funksiya garmonikani ifodalaydi:

$$\begin{aligned} f(x) &= a \cos \alpha x + b \sin \alpha x = \sqrt{a^2 + b^2} \left(\frac{a}{\sqrt{a^2 + b^2}} \cos \alpha x + \frac{b}{\sqrt{a^2 + b^2}} \sin \alpha x \right) = \\ &= A(\sin \beta \cos \alpha x + \cos \beta \sin \alpha x) = A \sin(\alpha x + \beta), \end{aligned}$$

bunda $\sqrt{a^2 + b^2} = A, \quad \frac{a}{\sqrt{a^2 + b^2}} = \sin \beta, \quad \frac{b}{\sqrt{a^2 + b^2}} = \cos \beta.$

3°. Furiye qatorining ta'rif. Har bir hadi

$$u_n(x) = a_n \cos nx + b_n \sin nx, \quad (n = 0, 1, 2, \dots)$$

garmonikadan iborat ushbu

$$a_0 + \sum_{n=1}^{\infty} (a_n \cos nx + b_n \sin nx) \quad (4)$$

funksional qator *trigonometrik qator* deyiladi. Bunda

$$a_0, a_1, b_1, a_2, b_2, \dots, a_n, b_n, \dots$$

sonlar *trigonometrik qatorning koeffitsiyentlari* deyiladi.

Odatda, (4) trigonometrik qatorning qisman yig'indisi

$$T_n(x) = a_0 + \sum_{k=1}^n (a_k \cos kx + b_k \sin kx)$$

trigonometrik ko'phad deyiladi.

Aytaylik, $f(x)$ funksiya $[-\pi, \pi]$ da berilgan bo'lib, u shu oraliqda integrallanuvchi bo'lsin.

Ravshanki,

$$f(x) \cos nx, \quad f(x) \sin nx, \quad (n = 1, 2, 3, \dots)$$

funksiyalar ham integrallanuvchi bo'ladi. Yuqorida keltirilgan funksiyalarning integrallarini quyidagicha belgilaymiz:

$$\begin{aligned} a_0 &= \frac{1}{\pi} \int_{-\pi}^{\pi} f(x) dx, \\ a_n &= \frac{1}{\pi} \int_{-\pi}^{\pi} f(x) \cos nxdx, \quad (n = 1, 2, \dots) \\ b_n &= \frac{1}{\pi} \int_{-\pi}^{\pi} f(x) \sin nxdx, \quad (n = 1, 2, \dots) \end{aligned} \quad (5)$$

$$\text{So'ng ushbu} \quad \frac{a_0}{2} + \sum_{n=1}^{\infty} (a_n \cos nx + b_n \sin nx) \quad (6)$$

trigonometrik qatorni tuzamiz.

Ravshanki, (6) trigonometrik qator (5) munosabatlardan topiladigan

$$a_0, a_1, b_1, a_2, b_2, \dots, a_n, b_n, \dots$$

sonlar bilan to'la aniqlanadi.

I-ta'rif. Koeffitsiyentlari (5) munosabatlar bilan aniqlangan (6) trigonometrik qator $f(x)$ funksiyaning Furye qatori deyiladi. Bunda

$$a_0, a_1, b_1, a_2, b_2, \dots, a_n, b_n, \dots$$

sonlar $f(x)$ funksiyaning Furye koeffitsiyentlari deyiladi.

Demak, $f(x)$ funksiyaning Furye qatori shunday trigonometrik qatorki, uning koeffitsiyentlari (5) formulalar yordamida aniqlanadi. Shuni e'tiborga olib, funksiyaning Furye qatori quyidagicha yoziladi:

$$f(x) \sim \frac{a_0}{2} + \sum_{n=1}^{\infty} (a_n \cos nx + b_n \sin nx).$$

1- misol. Ushbu

$$f(x) = e^{\alpha x}, \quad (-\pi \leq x \leq \pi, \alpha \neq 0)$$

funksiyaning Furye qatori topilsin.

◀ (5) formulalardan foydalanib, berilgan funksiyaning Furye koefitsiyentlarini hisoblaymiz:

$$a_0 = \frac{1}{\pi} \int_{-\pi}^{\pi} e^{\alpha x} dx = \frac{1}{\alpha\pi} (e^{\alpha\pi} - e^{-\alpha\pi}) = \frac{2}{\alpha\pi} \operatorname{sh} \alpha\pi,$$

$$\begin{aligned} a_n &= \frac{1}{\pi} \int_{-\pi}^{\pi} e^{\alpha x} \cos nx dx = \frac{1}{\pi} \cdot \frac{\alpha \cos nx + n \sin nx}{\alpha^2 + n^2} e^{\alpha x} \Big|_{-\pi}^{\pi} = \\ &= (-1)^n \frac{1}{\pi} \cdot \frac{2\alpha}{\alpha^2 + n^2} \operatorname{sh} \alpha\pi, \quad (n = 1, 2, \dots), \end{aligned}$$

$$\begin{aligned} b_n &= \frac{1}{\pi} \int_{-\pi}^{\pi} e^{\alpha x} \sin nx dx = \frac{1}{\pi} \cdot \frac{\alpha \sin nx - n \cos nx}{\alpha^2 + n^2} e^{\alpha x} \Big|_{-\pi}^{\pi} = \\ &= (-1)^{n-1} \frac{1}{\pi} \cdot \frac{2n}{\alpha^2 + n^2} \operatorname{sh} \alpha\pi, \quad (n = 1, 2, \dots). \end{aligned}$$

Demak,

$$f(x) = e^{\alpha x}$$

funksiyaning Furye qatori

$$\begin{aligned} f(x) &= e^{\alpha x} \sim \frac{a_0}{2} + \sum_{n=1}^{\infty} (a_n \cos nx + b_n \sin nx) = \\ &= \frac{2 \operatorname{sh} \alpha\pi}{\pi} \left[\frac{1}{2\alpha} + \sum_{n=1}^{\infty} \frac{(-1)^n}{\alpha^2 + n^2} (\alpha \cos nx - n \sin nx) \right] \end{aligned}$$

bo'ladi. ►

Aytaylik, ushbu shartlar bajarilsin:

1) Quyidagi

$$\frac{a_0}{2} + \sum_{n=1}^{\infty} (a_n \cos nx + b_n \sin nx) \quad (7)$$

trigonometrik qator $[-\pi, \pi]$ da yaqinlashuvchi va uning yig'indisi $f(x)$ ga teng:

$$f(x) = \frac{a_0}{2} + \sum_{n=1}^{\infty} (a_n \cos nx + b_n \sin nx); \quad (8)$$

2) (8) ifoda hamda uni $\cos kx$ va $\sin kx$ larga ($k=0,1,2,\dots$) ko'paytirishdan hosil bo'lgan

$$f(x) \cos kx = \frac{a_0}{2} \cos kx + \sum_{n=1}^{\infty} (a_n \cos nx \cos kx + b_n \sin nx \cos kx),$$

$$f(x) \sin kx = \frac{a_0}{2} \sin kx + \sum_{n=1}^{\infty} (a_n \cos nx \sin kx + b_n \sin nx \sin kx),$$

qatorlar $[-\pi, \pi]$ da hadlab integrallansin. U holda

$$a_0, a_1, b_1, a_2, b_2, \dots, a_n, b_n, \dots$$

sonlar $f(x)$ funksiyaning Furye koeffitsiyentlari bo'ladi, (7) trigonometrik qator esa $f(x)$ funksiyaning Furye qatori bo'ladi. Bu tasdiqning isboti quyidagi

$$\int_{-\pi}^{\pi} f(x) dx, \quad \int_{-\pi}^{\pi} f(x) \cos kx dx, \quad \int_{-\pi}^{\pi} f(x) \sin kx dx$$

integrallarni hisoblashdan kelib chiqadi.

4°. Juft va toq funksiyalarning Furye qatori. Faraz qilaylik, $f(x)$ funksiya $[-\pi, \pi]$ da berilgan juft funksiya bo'lib, u shu oraliqda integrallanuvchi bo'lsin. Bu funksiyaning Furye koeffitsiyentlarini topamiz:

$$\begin{aligned} a_n &= \frac{1}{\pi} \int_{-\pi}^{\pi} f(x) \cos nxdx = \frac{1}{\pi} \left[\int_{-\pi}^0 f(x) \cos nxdx + \int_0^{\pi} f(x) \cos nxdx \right] = \\ &= \frac{2}{\pi} \int_0^{\pi} f(x) \cos nxdx, \quad (n = 0, 1, 2, \dots), \end{aligned}$$

$$\begin{aligned} b_n &= \frac{1}{\pi} \int_{-\pi}^{\pi} f(x) \sin nxdx = \frac{1}{\pi} \left[\int_{-\pi}^0 f(x) \sin nxdx + \int_0^{\pi} f(x) \sin nxdx \right] = \\ &= \frac{1}{\pi} \left[- \int_0^{\pi} f(x) \sin nxdx + \int_0^{\pi} f(x) \sin nxdx \right] = 0, \quad (n = 1, 2, \dots). \end{aligned}$$

Demak, juft $f(x)$ funksiyaning Furiye koeffitsiyentlari

$$a_n = \frac{2}{\pi} \int_0^{\pi} f(x) \cos nx dx, \quad (n = 0, 1, 2, \dots)$$

$$b_n = 0, \quad (n = 1, 2, \dots)$$

bo'lib, Furiye qatori

$$f(x) \sim \frac{a_0}{2} + \sum_{n=1}^{\infty} a_n \cos nx$$

bo'ladi.

Aytaylik, $f(x)$ funksiya $[-\pi, \pi]$ da berilgan toq funksiya bo'lib, u shu oraliqda integrallanuvchi bo'lsin. Bu funksiyaning Furiye koeffitsiyentlarini topamiz:

$$\begin{aligned} a_n &= \frac{1}{\pi} \int_{-\pi}^{\pi} f(x) \cos nx dx = \frac{1}{\pi} \left[\int_{-\pi}^0 f(x) \cos nx dx + \int_0^{\pi} f(x) \cos nx dx \right] = \\ &= \frac{1}{\pi} \left[-\int_0^{\pi} f(x) \cos nx dx - \int_0^{\pi} f(x) \cos nx dx \right] = 0, \quad (n = 0, 1, 2, \dots), \end{aligned}$$

$$\begin{aligned} b_n &= \frac{1}{\pi} \int_{-\pi}^{\pi} f(x) \sin nx dx = \frac{1}{\pi} \left[\int_{-\pi}^0 f(x) \sin nx dx + \int_0^{\pi} f(x) \sin nx dx \right] = \\ &= \frac{2}{\pi} \left[\int_0^{\pi} f(x) \sin nx dx \right], \quad (n = 1, 2, \dots). \end{aligned}$$

Demak, $f(x)$ toq funksiyaning Furiye koeffitsiyentlari

$$a_n = 0, \quad (n = 0, 1, 2, \dots),$$

$$b_n = \frac{2}{\pi} \int_0^{\pi} f(x) \sin nx dx, \quad (n = 1, 2, \dots)$$

bo'lib, Furiye qatori quyidagidan iborat:

$$f(x) \sim \sum_{n=1}^{\infty} b_n \sin nx.$$

2- misol. Ushbu $f(x) = x^2$, $(-\pi \leq x \leq \pi)$ juft funksiyaning Furye qatori topilsin.

◀ Avvalo berilgan funksiyaning Furye koeffitsiyentlarini topamiz:

$$a_0 = \frac{2}{\pi} \int_0^{\pi} x^2 dx = \frac{2}{3} \pi^2,$$

$$\begin{aligned} a_n &= \frac{2}{\pi} \int_0^{\pi} x^2 \cos nx dx = \frac{2}{\pi} x^2 \frac{\sin nx}{n} \Big|_0^{\pi} - \frac{4}{\pi n} \int_0^{\pi} x \sin nx dx = \\ &= \frac{4}{\pi n} \left(\frac{x \cos nx}{n} \Big|_0^{\pi} - \frac{1}{n} \int_0^{\pi} \cos nx dx \right) = (-1)^n \cdot \frac{4}{n^2}, \quad (n = 1, 2, \dots). \end{aligned}$$

Demak, $f(x) = x^2$ funksiyaning Furye qatori

$$f(x) \sim x^2 - \frac{\pi^2}{3} + 4 \sum_{n=1}^{\infty} (-1)^n \frac{\cos nx}{n^2}$$

bo'ladi. ▶

3- misol. Ushbu $f(x) = x$, $(-\pi \leq x \leq \pi)$ toq funksiyaning Furye qatori topilsin.

◀ Berilgan funksiyaning Furye koeffitsiyentlarini hisoblaymiz:

$$b_n = \frac{2}{\pi} \int_0^{\pi} x \sin nx dx = \frac{2}{\pi} \left(-\frac{x \cos nx}{n} \Big|_0^{\pi} + \frac{1}{n} \int_0^{\pi} \cos nx dx \right) = \frac{2(-1)^{n-1}}{n}.$$

Demak, $f(x) = x$ funksiyaning Furye qatori

$$f(x) \sim \sum_{n=1}^{\infty} (-1)^{n-1} \frac{2}{n} \sin nx$$

bo'ladi. ▶

5°. $[-l, l]$ oraliqda berilgan funksiyaning Furye qatori. Faraz qilaylik, $f(x)$ funksiya $[-l, l]$ oraliqda ($l > 0$) berilgan bo'lib, u shu oraliqda integrallanuvchi bo'lsin.

Ravshanki, ushbu $t = \frac{\pi}{l} x$ almashtirish natijasida $[-l, l]$ oraliq $[-\pi, \pi]$ oraliqqa o'tadi. Agar

$$f(x) = f\left(\frac{1}{\pi}t\right) = \varphi(t)$$

deyilsa, $\varphi(t)$ funksiya $[-\pi, \pi]$ oraliqda berilgan va shu oraliqda integral-lanuvchi funksiya bo'ladi. Uning Furiye qatori

$$\varphi(t) \sim \frac{a_0}{2} + \sum_{n=1}^{\infty} (a_n \cos nt + b_n \sin nt)$$

bo'lib,
$$a_n = \frac{1}{\pi} \int_{-\pi}^{\pi} \varphi(t) \cos ntdt, \quad (n = 0, 1, 2, \dots)$$

$$b_n = \frac{1}{\pi} \int_{-\pi}^{\pi} \varphi(t) \sin ntdt, \quad (n = 1, 2, \dots)$$

bo'ladi. Endi $t = \frac{\pi}{l}x$ bo'lishini e'tiborga olib topamiz:

$$\varphi\left(\frac{\pi}{l}x\right) \sim \frac{a_0}{2} + \sum_{n=1}^{\infty} \left(a_n \cos n\frac{\pi}{l}x + b_n \sin n\frac{\pi}{l}x\right),$$

$$a_n = \frac{1}{l} \int_{-l}^l \varphi\left(\frac{\pi}{l}x\right) \cos n\frac{\pi}{l}x dx, \quad (n = 0, 1, 2, \dots),$$

$$b_n = \frac{1}{l} \int_{-l}^l \varphi\left(\frac{\pi}{l}x\right) \sin n\frac{\pi}{l}x dx, \quad (n = 1, 2, \dots).$$

Natijada berilgan $f(x)$ funksiyaning Furiye qatori quyidagicha

$$f(x) \sim \frac{a_0}{2} + \sum_{n=1}^{\infty} \left(a_n \cos \frac{n\pi x}{l} + b_n \sin \frac{n\pi x}{l}\right)$$

bo'lib, bunda:

$$a_n = \frac{1}{l} \int_{-l}^l f(x) \cos \frac{n\pi x}{l} dx, \quad (n = 0, 1, 2, \dots)$$

$$b_n = \frac{1}{l} \int_{-l}^l f(x) \sin \frac{n\pi x}{l} dx, \quad (n = 1, 2, \dots).$$

4- misol. Ushbu $f(x) = e^x$, $(-1 \leq x \leq 1)$ funksiyaning Furye qatori topilsin.

◀ Yuqoridagi formulalardan foydalanib, $f(x) = e^x$ funksiyaning Furye koefitsiyentlarini topamiz:

$$a_0 = \int_{-1}^1 e^x dx = e - e^{-1},$$

$$a_n = \int_{-1}^1 e^x \cos n\pi x dx = \frac{n\pi \sin n\pi x - \cos n\pi x}{1+n^2\pi^2} e^x \Big|_{-1}^1 =$$

$$= \frac{1}{1+n^2\pi^2} (e \cos n\pi - e^{-1} \cos n\pi) = (-1)^n \frac{e - e^{-1}}{1+n^2\pi^2}, \quad (n = 1, 2, \dots),$$

$$b_n = \int_{-1}^1 e^x \sin n\pi x dx = \frac{\sin n\pi x - n\pi \cos n\pi x}{1+n^2\pi^2} e^x \Big|_{-1}^1 =$$

$$= \frac{1}{1+n^2\pi^2} (en\pi \cos n\pi + n\pi e^{-1} \cos n\pi) = \frac{n\pi(-1)^n}{1+n^2\pi^2} (e^{-1} - e) =$$

$$= (-1)^{n+1} \frac{e - e^{-1}}{1+n^2\pi^2}, \quad (n = 1, 2, \dots).$$

Demak,

$$f(x) = e^x, \quad (-1 \leq x \leq 1)$$

funksiyaning Furye qatori quyidagicha

$$e^x - \frac{e - e^{-1}}{2} + (e - e^{-1}) \sum_{n=1}^{\infty} \left[\frac{(-1)^n}{1+n^2\pi^2} \cos n\pi x + \frac{(-1)^{n+1}}{1+n^2\pi^2} n\pi \sin n\pi x \right]$$

ko'inishda bo'ladi. ►

Mashqlar

1. Ushbu $f(x) = 2 \sin(2x + 2)$ garmonikaning grafigi topilsin.
2. Ushbu $f(x) = |x|$, $(-\pi \leq x \leq \pi)$ funksiyaning Furye qatori topilsin.

73- ma'ruza

Furye qatorining yaqinlashuvchanligi

1°. Lemmalar. Furye qatorining yaqinlashishini isbotlashda muhim bo'lgan lemmalarni keltiramiz.

1- lemma. Agar $\varphi(x)$ funksiya $[a, b]$ da integrallanuvchi bo'lsa,

$$\lim_{p \rightarrow \infty} \int_a^b \varphi(x) \sin px \, dx = 0, \quad \lim_{p \rightarrow \infty} \int_a^b \varphi(x) \cos px \, dx = 0$$

bo'ladi.

◀ Ravshanki, lemmaning shartidan

$$\varphi(x) \sin px, \quad \varphi(x) \cos px$$

funksiyalar $[a, b]$ da integrallanuvchi bo'ladi. $[a, b]$ segmentda

$x_0, x_1, \dots, x_{n-1}, x_n$, ($a = x_0 < x_1 < x_2 < \dots < x_{n-1} < x_n = b$) nuqtalarni olib,

$$\int_a^b \varphi(x) \sin px \, dx$$

ni quyidagicha yozib olamiz:

$$\begin{aligned} \int_a^b \varphi(x) \sin px \, dx &= \sum_{k=0}^{n-1} \int_{x_k}^{x_{k+1}} \varphi(x) \sin px \, dx = \\ &= \sum_{k=0}^{n-1} \int_{x_k}^{x_{k+1}} [\varphi(x) - m_k] \sin px \, dx + \sum_{k=0}^{n-1} m_k \int_{x_k}^{x_{k+1}} \sin px \, dx, \end{aligned} \quad (1)$$

bunda $m_k = \inf_{x \in [x_k, x_{k+1}]} \varphi(x)$, ($k = 0, 1, 2, \dots, n-1$).

Bu (1) tenglikning o'ng tomonidagi integrallarni baholaymiz:

$$\left| \sum_{k=0}^{n-1} \int_{x_k}^{x_{k+1}} [\varphi(x) - m_k] \sin px \, dx \right| \leq \sum_{k=0}^{n-1} \int_{x_k}^{x_{k+1}} \omega_k \, dx = \sum_{k=0}^{n-1} \omega_k \Delta x_k,$$

bunda ω_k – funksiya $\varphi(x)$ ning $[x_k, x_{k+1}]$ dagi tebranishi, $\Delta x_k = x_{k+1} - x_k$.

Modomiki, $\varphi(x)$ funksiya $[a, b]$ da integrallanuvchi ekan, u holda

$$\sum_{k=0}^{n-1} \varpi_k \Delta x_k < \frac{\varepsilon}{2} \quad (2)$$

qilib olinishi mumkin.

Endi (1) tenglikning o'ng tomonidagi ikkinchi integralni baholaymiz:

$$\left| \sum_{k=0}^{n-1} m_k \int_{x_k}^{x_{k+1}} \sin px \, dx \right| \leq \sum_{k=0}^{n-1} |m_k| \cdot \left| \frac{\cos px_k - \cos px_{k+1}}{p} \right| \leq \sum_{k=0}^{n-1} |m_k| \cdot \frac{2}{p} = \frac{2}{p} \sum_{k=0}^{n-1} |m_k|.$$

Ravshanki, p ni yetarlicha katta qilib olish hisobiga

$$\frac{2}{p} \sum_{k=0}^{n-1} |m_k| < \frac{\varepsilon}{2} \quad (3)$$

ga erishish mumkin. Natijada (1), (2) va (3) munosabatlardan

$$\left| \int_a^b \varphi(x) \sin px \, dx \right| < \varepsilon$$

bo'lishi va undan

$$\lim_{p \rightarrow \infty} \int_a^b \varphi(x) \sin px \, dx = 0$$

ifoda kelib chiqadi. Xuddi shunga o'xshash

$$\lim_{p \rightarrow \infty} \int_a^b \varphi(x) \cos px \, dx = 0$$

isbotlanadi. ►

Agar $[a, b]$ oraliqni shunday

$$[a_0, a_1], [a_1, a_2], \dots, [a_{n-1}, a_n], \quad (a_0 = a, a_n = b)$$

bo'laklarga ajratish mumkin bo'lsaki, har bir (a_k, a_{k+1}) da ($k = 0, 1, 2, \dots, n-1$) $f(x)$ funksiya uzluksiz bo'lib, $x = a_k$ nuqtalarida chekli o'ng

$$f(a_k + 0), \quad (k = 0, 1, 2, \dots, n-1),$$

va chap

$$f(a_k - 0), \quad (k = 0, 1, 2, \dots, n)$$

limitlarga ega bo'lsa, $f(x)$ funksiya $[a, b]$ da bo'lakli uzluksiz deyiladi.

Yuqoridagi lemma $\varphi(x)$ funksiya $[a, b]$ da bo'lakli uzluksiz funksiya bo'lgan holda ham o'rinli bo'ladi.

1- lemmadan quyidagi natija kelib chiqadi.

Natija. Agar $f(x)$ funksiya $[-\pi, \pi]$ oraliqda bo'lakli uzluksiz bo'lsa, uning Furye koeffitsiyentlari $n \rightarrow \infty$ da nolga intiladi:

$$\lim_{n \rightarrow \infty} a_n = \lim_{n \rightarrow \infty} \frac{1}{\pi} \int_{-\pi}^{\pi} f(x) \cos nx \, dx = 0,$$

$$\lim_{n \rightarrow \infty} b_n = \lim_{n \rightarrow \infty} \frac{1}{\pi} \int_{-\pi}^{\pi} f(x) \sin nx \, dx = 0.$$

2- lemma. Ushbu $\frac{1}{2} + \sum_{k=1}^n \cos ku = \frac{\sin(2n+1)\frac{u}{2}}{2 \sin \frac{u}{2}}$ tenglik o'rinli.

◀ Ravshanki,

$$\frac{1}{2} + \sum_{k=1}^n \cos ku = \frac{1}{2 \sin \frac{u}{2}} \left[\sin \frac{u}{2} + \sum_{k=1}^n 2 \sin \frac{u}{2} \cos ku \right]$$

bo'ladi. Agar

$$\sum_{k=1}^n 2 \sin \frac{u}{2} \cos ku = \sum_{k=1}^n \left[\sin \left(k + \frac{1}{2} \right) u - \sin \left(k - \frac{1}{2} \right) u \right] = \sin \left(n + \frac{1}{2} \right) u - \sin \frac{u}{2}$$

bo'lishini e'tiborga olsak, u holda yuqoridagi tenglikdan

$$\frac{1}{2} + \sum_{k=1}^n \cos ku = \frac{\sin(2n+1)\frac{u}{2}}{2 \sin \frac{u}{2}}$$

tenglikni keltirib chiqaramiz. ▶

2°. Furye qatorining qisman yig'indisi. Dirixle integrali. Funktsional qatorlar nazariyasidan ma'lumki, qatorning yaqinlashishini aniqlashda

avvalo uning qisman yig'indisi topilib, so'ngra bu qisman yig'indining limiti o'rganilar edi.

Funksiya Furiye qatorining yaqinlashishini aniqlashda ham avvalo uning qisman yig'indisi topiladi.

Aytaylik, $f(x)$ funksiya $[-\pi, \pi]$ oraliqda integrallanuvchi bo'lsin. Bu funksiyaning Furiye koeffitsiyentlarini topib, uning Furiye qatorini tuzamiz:

$$a_k = \frac{1}{\pi} \int_{-\pi}^{\pi} f(t) \cos kt \, dt, \quad (k = 0, 1, 2, \dots),$$

$$b_k = \frac{1}{\pi} \int_{-\pi}^{\pi} f(t) \sin kt \, dt, \quad (k = 1, 2, \dots),$$

$$f(x) \sim \frac{a_0}{2} + \sum_{k=1}^{\infty} (a_k \cos kx + b_k \sin kx).$$

Ravshanki, bu qatorning qisman yig'indisi

$$F_n(f; x) = \frac{a_0}{2} + \sum_{k=1}^n (a_k \cos kx + b_k \sin kx)$$

bo'ladi. Bu tenglikdagi a_k va b_k larning o'rniga ularning yuqorida keltirilgan ifodalarini qo'yib topamiz:

$$\begin{aligned} F_n(f; x) &= \frac{1}{2\pi} \int_{-\pi}^{\pi} f(t) \, dt + \sum_{k=1}^n \frac{1}{\pi} \int_{-\pi}^{\pi} f(t) [\cos kt \cos kx + \sin kt \sin kx] \, dt = \\ &= \frac{1}{\pi} \int_{-\pi}^{\pi} f(t) \left[\frac{1}{2} + \sum_{k=1}^n \cos k(t-x) \right] \, dt. \end{aligned}$$

Ma'lumki, 2- lemmaga ko'ra

$$\frac{1}{2} + \sum_{k=1}^n \cos k(t-x) = \frac{\sin(2n+1)\frac{t-x}{2}}{2 \sin \frac{t-x}{2}}$$

bo'ladi. U holda $F_n(f; x)$ yig'indi quyidagi ko'rinishga keladi:

$$F_n(f; x) = \frac{1}{2\pi} \int_{-\pi}^{\pi} f(t) \frac{\sin(2n+1)\frac{t-x}{2}}{2 \sin \frac{t-x}{2}} dt. \quad (4)$$

Odatda, (4) tenglikning o'ng tomonidagi integral $f(x)$ funksiyaning *Dirixle integrali* deyiladi.

$F_n(f; x)$ yig'indining bu ifodasini yanada o'zgartirib, $n \rightarrow \infty$ da $F_n(f; x)$ ning limitini topishga qulaylik keltiradigan ko'rinishga olib kelamiz.

Avvalo (4) integralda $t - x = u$ almashtirishni bajaramiz. Bunda integral ostidagi funksiya 2π davrli bo'lganligi sababli integrallash chegarasining o'zgaray qolishini e'tiborga olib topamiz:

$$F_n(f; x) = \frac{1}{2\pi} \int_{-\pi}^{\pi} f(x+u) \frac{\sin(2n+1)\frac{u}{2}}{2 \sin \frac{u}{2}} du.$$

Bu tenglikni ikki qismga ajratib:

$$F_n(f; x) = \frac{1}{2\pi} \left[\int_{-\pi}^0 f(x+u) \frac{\sin(2n+1)\frac{u}{2}}{2 \sin \frac{u}{2}} du + \int_0^{\pi} f(x+u) \frac{\sin(2n+1)\frac{u}{2}}{2 \sin \frac{u}{2}} du \right],$$

o'ng tomondagi birinchi integralda u ni $-u$ ga almashtirib topamiz:

$$F_n(f; x) = \frac{1}{\pi} \int_0^{\pi} [f(x+u) + f(x-u)] \frac{\sin(2n+1)\frac{u}{2}}{2 \sin \frac{u}{2}} du.$$

Xususan, $f(x) \equiv 1$ bo'lganda

$$F_n(1; x) = \frac{1}{\pi} \int_0^{\pi} \frac{\sin\left(n+\frac{1}{2}\right)u}{2 \sin \frac{u}{2}} du$$

bo'lib, u 1 ga teng bo'ladi.

Haqiqatan ham, 2- lemmadan foydalansak, u holda

$$\begin{aligned}
 F_n(1, x) &= \frac{1}{\pi} \int_0^{\pi} 2 \left[\frac{1}{2} + \sum_{k=1}^n \cos ku \right] du = 1 + \frac{2}{\pi} \sum_{k=1}^n \int_0^{\pi} \cos kudu = \\
 &= 1 + \frac{2}{\pi} \sum_{k=1}^n \frac{\sin ku}{k} \Bigg|_{u=0}^{u=\pi} = 1
 \end{aligned}$$

bo'lishi kelib chiqadi. Demak,

$$1 = \frac{1}{\pi} \int_0^{\pi} \frac{\sin\left(n + \frac{1}{2}\right)u}{2 \sin \frac{u}{2}} du. \quad (5)$$

3°. Lokallashtirish prinsipi. $f(x)$ funksiya Furye qatorining qismaniy yig'indisi

$$F_n(f; x) = \frac{1}{\pi} \int_0^{\pi} [f(x+u) + f(x-u)] \frac{\sin\left(n + \frac{1}{2}\right)u}{2 \sin \frac{u}{2}} du \quad (6)$$

ning bitta muhim xossasini keltiramiz.

Ixtiyoriy δ sonni ($0 < \delta < \pi$) olib, (6) integralni ikkita integralga ajratamiz:

$$\begin{aligned}
 F_n(f; x) &= \frac{1}{\pi} \int_0^{\delta} [f(x+u) + f(x-u)] \frac{\sin\left(n + \frac{1}{2}\right)u}{2 \sin \frac{u}{2}} du + \\
 &+ \frac{1}{\pi} \int_{\delta}^{\pi} [f(x+u) + f(x-u)] \frac{\sin\left(n + \frac{1}{2}\right)u}{2 \sin \frac{u}{2}} du = J_1(n, \delta) + J_2(n, \delta).
 \end{aligned} \quad (7)$$

1- teorema. $n \rightarrow \infty$ da $J_2(n, \delta)$ ning limiti nolga teng bo'ladi:

$$\lim_{n \rightarrow \infty} J_2(n, \delta) = 0.$$

◀ $f(x)$ funksiya $[-\pi, \pi]$ da integrallanuvchi bo'lganligi sababli

$$\varphi(u) = \frac{1}{2 \sin \frac{u}{2}} [f(x+u) + f(x-u)]$$

funksiya ham $[\delta, \pi]$ da integrallanuvchi bo'ladi. U holda 1- lemmaga ko'ra

$$\begin{aligned} \lim_{n \rightarrow \infty} J_2(n, \delta) &= \lim_{n \rightarrow \infty} \frac{1}{\pi} \int_{\delta}^{\pi} [f(x+u) + f(x-u)] \frac{\sin\left(n + \frac{1}{2}\right)u}{2 \sin \frac{u}{2}} du = \\ &= \frac{1}{\pi} \lim_{n \rightarrow \infty} \int_{\delta}^{\pi} \varphi(u) \sin\left(n + \frac{1}{2}\right)u du = 0 \end{aligned}$$

bo'ladi. ►

(7) munosabat va keltirilgan teoremdan muhim natija kelib chiqadi. Ushbu

$$J_1(n, \delta) = \frac{1}{\pi} \int_0^{\delta} [f(x+u) + f(x-u)] \frac{\sin\left(n + \frac{1}{2}\right)u}{2 \sin \frac{u}{2}} du$$

integralning $n \rightarrow \infty$ dagi limiti mavjud bo'lgandagina $F_n(f; x)$ ning limiti mavjud va

$$\lim_{n \rightarrow \infty} F_n(f, x) = \lim_{n \rightarrow \infty} J_1(n, \delta)$$

munosabat o'rinli bo'ladi.

Ma'lumki, $J_1(n, \delta)$ integralda f funksiyaning $[x - \delta, x + \delta]$ oralig'dagi qiymatlarigina qatnashadi.

Demak, $f(x)$ funksiya Furye qatorining x nuqtada yaqinlashuvchanligi yoki uzoqlashuvchanligi bu funksiyaning shu nuqta atrofi $(x - \delta, x + \delta)$ dagi qiymatlarigagina bog'liq bo'ladi. Buni *lokallash-tirish prinsipi* deb yuritiladi.

4°. Furye qatorining yaqinlashuvchanligi. Endi funksiya Furye qatorining yaqinlashishi haqidagi teoremani keltiramiz.

Agar har bir (a_k, a_{k+1}) da $(k = 0, 1, 2, \dots, n-1)$ $f(x)$ funksiya differensiallanuvchi bo'lib, $x = a_k$ nuqtalarda chekli o'ng

$$f'(a_k + 0), \quad (k = 0, 1, 2, \dots, n-1)$$

va chap

$$f'(a_k - 0), \quad (k = 0, 1, 2, \dots, n)$$

hosilalarga ega bo'lsa, $f(x)$ funksiya $[a, b]$ da *bo'lakli differensiallanuvchi* deyiladi.

2- teorema. 2π davrli $f(x)$ funksiya $[-\pi, \pi]$ oraliqda bo'lakli differensiallanuvchi bo'lsa, u holda bu funksiyaning Furye qatori

$$f(x) \sim \frac{a_0}{2} + \sum_{k=1}^{\infty} (a_k \cos kx + b_k \sin kx)$$

$[-\pi, \pi]$ da yaqinlashuvchi bo'lib, uning yig'indisi

$$\frac{f(x+0)+f(x-0)}{2}$$

ga teng bo'ladi.

◀ (5) tenglikning har ikki tomonini

$$\frac{1}{2} [f(x+0) + f(x-0)]$$

ga ko'paytirib, ushbu

$$F_n(f; x) - \frac{1}{2} [f(x+0) + f(x-0)]$$

ayirmani quyidagicha

$$\begin{aligned} & F_n(f; x) - \frac{1}{2} [f(x+0) + f(x-0)] = \\ & = \frac{1}{\pi} \int_0^{\pi} [f(x+u) + f(x-u) - f(x+0) - f(x-0)] \frac{\sin\left(n+\frac{1}{2}\right)u}{2 \sin \frac{u}{2}} du \end{aligned}$$

ko'rishda yozib olamiz. Bu tenglikning o'ng tomonidagi integralni ikkita

$$J_1 = \frac{1}{\pi} \int_0^{\pi} [f(x+u) - f(x+0)] \frac{\sin\left(n+\frac{1}{2}\right)u}{2 \sin \frac{u}{2}} du,$$

$$J_2 = \frac{1}{\pi} \int_0^{\pi} [f(x-u) - f(x-0)] \frac{\sin\left(n+\frac{1}{2}\right)u}{2 \sin \frac{u}{2}} du$$

integralga ajratamiz. Natijada

$$F_n(f; x) - \frac{1}{2}[f(x+0) + f(x-0)] = J_1 + J_2$$

bo'ladi.

Endi J_1 va J_2 integrallarni baholaymiz. J_1 integralni baholash uchun avvalo ixtiyoriy δ ($0 < \delta < \pi$) sonni olib, J_1 ni ikki qismga ajratib yozamiz:

$$J_1 = \frac{1}{\pi} \int_0^{\delta} [f(x+u) - f(x+0)] \frac{\sin\left(n+\frac{1}{2}\right)u}{2 \sin \frac{u}{2}} du + \frac{1}{\pi} \int_{\delta}^{\pi} [f(x+u) - f(x+0)] \frac{\sin\left(n+\frac{1}{2}\right)u}{2 \sin \frac{u}{2}} du. \quad (8)$$

Lokallashtirish prinsipiga asosan

$$\lim_{n \rightarrow \infty} \frac{1}{\pi} \int_{\delta}^{\pi} [f(x+u) - f(x+0)] \frac{\sin\left(n+\frac{1}{2}\right)u}{2 \sin \frac{u}{2}} du = 0.$$

Demak, $\forall \varepsilon > 0, \exists n_0 = n(\varepsilon, \delta) \in \mathbb{N}, \forall n > n_0$ da

$$\left| \frac{1}{\pi} \int_{\delta}^{\pi} [f(x+u) - f(x+0)] \frac{\sin\left(n+\frac{1}{2}\right)u}{2 \sin \frac{u}{2}} du \right| < \frac{\varepsilon}{2} \quad (9)$$

bo'ladi. Shartga ko'ra, $f(x)$ funksiya $[-\pi, \pi]$ da bo'lakli differensiallanuvchi. U holda $\forall x \in [-\pi, \pi]$ da

$$\lim_{u \rightarrow +0} \frac{f(x+u) - f(x+0)}{u} = f'(x+0)$$

mavjud bo'lib, $\exists \delta_1 > 0, 0 < u < \delta_1$ da

$$\left| \frac{f(x+u) - f(x+0)}{u} \right| \leq M_1, \quad (M_1 = \text{const})$$

tengsizlik o'rinli bo'ladi. Shuningdek, $\exists \delta_2 > 0$, $0 < u < \delta_2$ da

$$\frac{\frac{u}{2}}{\sin \frac{u}{2}} \leq M_2, \quad (M_2 = \text{const})$$

tengsizlik bajariladi.

Endi $\min \left\{ \delta_1, \delta_2, \frac{\pi \varepsilon}{2M_1M_2} \right\} = \delta$ deb olamiz. Natijada, $\forall n \in N$

bo'lganda (8) tenglikning o'ng tomonidagi birinchi integral uchun ushbu

$$\begin{aligned} & \left| \frac{1}{\pi} \int_0^{\delta} \left[\frac{f(x+u) - f(x+0)}{u} \right] \cdot \frac{\frac{u}{2}}{\sin \frac{u}{2}} \sin \left(n + \frac{1}{2} \right) u du \right| \leq \\ & \leq \frac{1}{\pi} \int_0^{\delta} \left[\left| \frac{f(x+u) - f(x+0)}{u} \right| \right] \cdot \frac{\frac{u}{2}}{\sin \frac{u}{2}} du \leq \frac{1}{\pi} M_1 M_2 \delta \leq \frac{\varepsilon}{2} \end{aligned} \quad (10)$$

bahoga ega bo'lamiz. (8), (9) va (10) munosabatlardan

$$|J_1| = \left| \frac{1}{\pi} \int_0^{\pi} [f(x+u) - f(x+0)] \frac{\sin \left(n + \frac{1}{2} \right) u}{2 \sin \frac{u}{2}} du \right| < \varepsilon$$

bo'lishi kelib chiqadi.

J_2 integral ham xuddi shunga o'xshash baholanadi va

$$|J_2| = \left| \frac{1}{\pi} \int_0^{\pi} [f(x-u) - f(x-0)] \frac{\sin \left(n + \frac{1}{2} \right) u}{2 \sin \frac{u}{2}} du \right| < \varepsilon$$

bo'lishi topiladi. Demak,

$$\left| F_n(f; x) - \frac{1}{2} [f(x+0) + f(x-0)] \right| < 2\varepsilon$$

bo'lib, undan

$$\lim_{n \rightarrow \infty} F_n(f; x) = \frac{1}{2} [f(x+0) + f(x-0)]$$

bo'lishi kelib chiqadi. Bu esa $f(x)$ funksiya Furye qatorining yaqinlashuvchi va

$$\frac{a_0}{2} + \sum_{k=1}^{\infty} (a_k \cos kx + b_k \sin kx) = \frac{1}{2} [f(x+0) + f(x-0)]$$

bo'lishini bildiradi. ►

Natija. Agar f funksiya yuqoridagi teoremaning shartlarini bajarib, x nuqtada uzluksiz bo'lsa, u holda quyidagi natijaga ega bo'lamiz:

$$\frac{a_0}{2} + \sum_{k=1}^{\infty} (a_k \cos kx + b_k \sin kx) = f(x).$$

Misol. Ushbu

$$f(x) = \cos ax, \quad (-\pi \leq x \leq \pi, \quad a \neq n \in \mathbb{Z})$$

funksiyaning Furye qatori topilsin va uni yaqinlashishga tekshirilsin.

◀ Bu funksiyaning Furye koeffitsiyentlarini topamiz. Qaralayotgan funksiya juft bo'lgani uchun

$$b_n = 0, \quad (n = 1, 2, 3, \dots)$$

bo'lib,

$$\begin{aligned} a_n &= \frac{2}{\pi} \int_0^{\pi} \cos ax \cos nxdx = \int_0^{\pi} [\cos(a-n)x + \cos(a+n)x] dx = \\ &= \frac{\sin a\pi}{\pi} (-1)^n \left[\frac{1}{a+n} + \frac{1}{a-n} \right] \end{aligned}$$

bo'ladi. Demak,

$$f(x) \sim \frac{\sin a\pi}{\pi} \left[\frac{1}{a} + \sum_{n=1}^{\infty} (-1)^n \left(\frac{1}{a+n} + \frac{1}{a-n} \right) \cos nx \right].$$

Agar $f(x) = \cos ax$ funksiya teoremaning hamda natijaning shartlarini bajarishini e'tiborga olsak, u holda

$$\cos ax = \frac{\sin a\pi}{\pi} \left[\frac{1}{a} + \sum_{n=1}^{\infty} (-1)^n \left(\frac{1}{a+n} + \frac{1}{a-n} \right) \cos nx \right]$$

bo'lishini topamiz. ►

Keyingi tenglikda $x = 0$ deyilsa,

$$\frac{\pi}{\sin a\pi} = \frac{1}{a} + \sum_{n=1}^{\infty} (-1)^n \left(\frac{1}{a+n} + \frac{1}{a-n} \right) \quad (11)$$

bo'lishi kelib chiqadi.

Mashqlar

1. Ushbu

$$f(x) = \begin{cases} -x, & \text{agar } -\pi \leq x \leq 0 \text{ bo'lsa,} \\ 0, & \text{agar } 0 < x < \pi \text{ bo'lsa} \end{cases}$$

funksiyaning Furiye qatori topilsin va uni yaqinlashishga tekshirilsin.

2. Ushbu

$$f(x) = -\ln \left| \sin \frac{x}{2} \right|, \quad (x \neq 2k\pi, \quad k \in Z)$$

funksiyaning Furiye qatori topilsin va uni yaqinlashishga tekshirilsin.

15- B O B
PARAMETRGA BOG'LIQ INTEGRALLAR

74- ma'ruza

**Ikki o'zgaruvchili funksiyaning bir o'zgaruvchisi
bo'yicha yaqinlashishi**

1°. Limit funksiya. Faraz qilaylik, $f(x,y)$ funksiya R^2 fazodagi

$$M = \{(x,y) \in R^2 : a \leq x \leq b, y \in E \subset R\}$$

to'plamda berilgan va $y_0 \in R$ nuqta E to'plamning limit nuqtasi bo'lsin.

Ravshanki, har bir tayin $x \in [a,b]$ da $f(x,y)$ funksiya y o'zgaruvchining funksiyasiga aylanadi. Aytaylik, bu funksiya $x \in [a,b]$ da

$$\lim_{y \rightarrow y_0} f(x,y)$$

limitga ega bo'lsin.

Har bir $x \in [a,b]$ ga $f(x,y)$ funksiyaning $y \rightarrow y_0$ dagi limitini mos qo'yish natijasida

$$\varphi : x \rightarrow \lim_{y \rightarrow y_0} f(x,y)$$

funksiya hosil bo'ladi.

Odatda, bu funksiya $f(x,y)$ funksiyaning $y \rightarrow y_0$ dagi *limit funksiyasi* deyiladi:

$$\lim_{y \rightarrow y_0} f(x,y) = \varphi(x), \quad (x \in [a,b]). \quad (1)$$

(1) munosabat quyidagicha tushuniladi: $\forall \varepsilon > 0$ son olinganda ham shunday $\delta = \delta(\varepsilon, x) > 0$ son topiladiki, bunda $0 < |y - y_0| < \delta$ tengsizlikni qanoatlantiruvchi $\forall y \in E$ uchun

$$|f(x,y) - \varphi(x)| < \varepsilon, \quad (x \in [a,b])$$

bo'ladi.

Endi $f(x,y)$ funksiya

$$M = \{(x,y) \in R^2; x \in [a,b], y \in E \subset R\}$$

to'plamda berilgan va ∞ «nuqta» E to'plamning limit nuqtasi bo'lsin.

Agar $\forall \varepsilon > 0$ son olinganda ham shunday $\delta = \delta(\varepsilon, x) > 0$ son topilsaki, $|y| > \delta$ tengsizlikni qanoatlantiruvchi $\forall y \in E$ uchun

$$|f(x, y) - \varphi(x)| < \varepsilon$$

tengsizlik bajarilsa, $\varphi(x)$ funksiya $f(x, y)$ ning $y \rightarrow \infty$ dagi limit funksiyasi deyiladi.

1- misol. Ushbu $f(x, y) = xy$ funksiyani

$$M = \{(x, y) \in R^2 : 0 \leq x \leq 1, y \in [0, 1]\}$$

to'plamda qaraylik. Bu funksiyaning $y \rightarrow y_0 = 1$ dagi limit funksiyasi $\varphi(x) = x$ bo'lishi ko'rsatilsin.

◀ Ixtiyoriy $\varepsilon > 0$ songa ko'ra, har bir $x \in [0, 1]$ uchun $\delta = \varepsilon$ deb olinsa, u holda $|y - y_0| = |y - 1| < \delta$ tengsizlikni qanoatlantiruvchi $y \in [0, 1]$ uchun

$$|f(x, y) - \varphi(x)| = |xy - x| = |x||y - 1| \leq |y - 1| < \delta = \varepsilon$$

bo'ladi. Demak,

$$\lim_{y \rightarrow 1} xy = x. \blacktriangleright$$

2- misol. Ushbu $f(x, y) = x^y$, ($0^0 = 0$) funksiyani

$$M = \{(x, y) \in R^2 : 0 \leq x \leq 1, y \in [0, 1]\}$$

to'plamda qaraymiz. Bu funksiyaning $y \rightarrow y_0 = 0$ dagi limit funksiyasi topilsin.

◀ Aytaylik, $x = 0$ bo'lsin. Bu holda $\forall y \in [0, 1]$ uchun

$$f(0, y) = 0$$

bo'lib, $y \rightarrow 0$ da $f(0, y) \rightarrow 0$ bo'ladi.

Aytaylik, $x \neq 0$ bo'lsin. Bu holda $y \rightarrow 0$ da

$$f(x, y) = x^y \rightarrow x^0 = 1$$

bo'ladi. Haqiqatan ham, ixtiyoriy $\varepsilon > 0$ songa ko'ra $\delta = \log_x(1 - \varepsilon)$ deyilsa ($x > 0$), u holda $|y - y_0| = |y - 0| = |y| < \delta$ tengsizlikni qanoatlantiruvchi $y \in [0, 1]$ uchun

$$|f(x, y) - \varphi(x)| = |x^y - 1| = 1 - x^y < 1 - x^{\log_x(1 - \varepsilon)} = 1 - (1 - \varepsilon) = \varepsilon$$

bo'ladi. Demak, $y \rightarrow 0$ da $f(x, y) = x^y$ funksiyaning limit funksiyasi

$$\varphi(x) = \begin{cases} 1, & \text{agar } x \in (0, 1] \text{ bo'lsa,} \\ 0, & \text{agar } x = 0 \text{ bo'lsa} \end{cases}$$

bo'ladi. ►

2°. Limit funksiyaga tekis yaqinlashish. Faraz qilaylik, $f(x,y)$ funksiya

$$M = \{(x,y) \in R^2 : a \leq x \leq b, y \in E \subset R\}$$

to'plamda berilgan bo'lib, $y_0 \in R$ nuqta E to'plamning limit nuqtasi bo'lsin. Bu funksiya har bir tayinlangan $x \in [a,b]$ da y o'zgaruvchining funksiyasi sifatida $y \rightarrow y_0$ da limit funksiyaga ega bo'lsin:

$$\lim_{y \rightarrow y_0} f(x,y) = \varphi(x).$$

$f(x,y)$ funksiyaning $\varphi(x)$ ga intilish xarakteri olingan x ga bog'liq, chunki x ning turli qiymatlarida $f(x,y)$ funksiya, umuman aytganda, y o'zgaruvchining turlicha funksiyalari bo'ladi. Bu vaziyat

$$\lim_{y \rightarrow y_0} f(x,y) = \varphi(x), \quad (x \in [a,b])$$

tushunchasidagi ixtiyoriy $\varepsilon > 0$ songa ko'ra topiladigan $\delta > 0$ sonning qaralayotgan x ga bog'liq yoki bog'liq emasligida namoyon bo'ladi.

Yuqorida keltirilgan misollarning birinchisida $\delta = \varepsilon$ bo'lib, u faqat $\varepsilon > 0$ gagina bog'liq, ikkinchisida esa $\delta = \log_x(1 - \varepsilon)$ bo'lib, u olingan $\varepsilon > 0$ bilan birga qaralayotgan x ga ham bog'liq ekanini ko'ramiz.

1-ta'rif. Agar $\forall \varepsilon > 0$ son olinganda ham shunday $\delta = \delta(\varepsilon) > 0$ son topilsaki, $|y - y_0| < \delta$ tengsizlikni qanoatlantiruvchi $y \in E$, $\forall x \in [a,b]$ uchun

$$|f(x,y) - \varphi(x)| < \varepsilon$$

tengsizlik bajarilsa, ya'ni

$$\forall \varepsilon > 0, \exists \delta = \delta(\varepsilon) > 0, |y - y_0| < \delta, y \in E,$$

$$\forall x \in [a,b]: |f(x,y) - \varphi(x)| < \varepsilon$$

bo'lsa, $f(x,y)$ funksiya $\varphi(x)$ ga $[a,b]$ da tekis yaqinlashadi deyiladi.

3-misol. Ushbu $f(x,y) = x \sin y$ funksiyaning

$$M = \{(x,y) \in R^2: 0 \leq x \leq 1, y \in [0,\pi]\}$$

to'plamda qaraylik. Bu funksiyaning $y \rightarrow y_0 = \frac{\pi}{3}$ da limit funksiyasi topilib, unga $[0, 1]$ da tekis yaqinlashishi ko'rsatilsin.

◀ Ravshanki,

$$\lim_{y \rightarrow \frac{\pi}{3}} x \sin y = \frac{\sqrt{3}}{2} x.$$

Demak, $\varphi(x) = \frac{\sqrt{3}}{2} x$.

Agar $\forall \varepsilon > 0$ ga ko'ra $\delta = \varepsilon$ deyilsa, u holda $|y - \frac{\pi}{3}| < \delta$ tengsizlikni qanoatlantiruvchi $y \in [0, \pi]$ va $\forall x \in [0, 1]$ uchun

$$\begin{aligned} |f(x, y) - \varphi(x)| &= \left| x \sin y - \frac{\sqrt{3}}{2} x \right| = |x| \left| \sin y - \frac{\sqrt{3}}{2} \right| = \\ &= |x| \left| \sin y - \sin \frac{\pi}{3} \right| \leq \left| y - \frac{\pi}{3} \right| < \delta = \varepsilon \end{aligned}$$

bo'ladi. Ta'rifga binoan, $y \rightarrow \frac{\pi}{3}$ da $f(x, y) = x \sin y$ funksiya $\varphi(x) = \frac{\sqrt{3}}{2} x$ limit funksiyaga $[0, 1]$ da tekis yaqinlashadi. ►

Eslatma. Aytaylik, $\lim_{y \rightarrow y_0} f(x, y) = \varphi(x)$ bo'lsin.

Agar $\forall \delta > 0$ son olinganda shunday $\varepsilon_0 > 0$, $x_0 \in [a, b]$ va $|y - y_0| < \delta$ tengsizlikni qanoatlantiruvchi $y_1 \in E$ topilsaki, bunda

$$|f(x_0, y_1) - \varphi(x_0)| \geq \varepsilon_0$$

bo'lsa, $f(x, y)$ funksiya $y \rightarrow y_0$ da limit funksiya $\varphi(x)$ ga tekis yaqinlashmaydi deyiladi. Masalan,

$$f(x, y) = x^y, \quad (0^0 = 0)$$

funksiya $y \rightarrow 0$ da limit funksiya

$$\varphi(x) = \begin{cases} 1, & \text{agar } x \in (0, 1] \text{ bo'lsa,} \\ 0, & \text{agar } x = 0 \text{ bo'lsa} \end{cases}$$

ga tekis yaqinlashmaydi. Haqiqatan ham, $\forall \delta > 0$ son olinganda, $\varepsilon_0 = \frac{1}{4}$, $0 < y_1 < \delta$ tengsizlikni qanoatlantiruvchi y_1 va $x_0 = 2^{-\frac{1}{y_1}}$ deb olinsa, u holda

$$|f(x_0, y_1) - \varphi(x_0)| = 1 - x_0^{y_1} = 1 - \frac{1}{2} = \frac{1}{2} > \varepsilon_0$$

bo'ladi. Faraz qilaylik, $f(x, y)$ funksiya R^2 fazodagi

$$M = \{(x, y) \in R^2 : a \leq x \leq b, y \in E \subset R\}$$

to'plamda berilgan va $y_0 \in R$ nuqta E to'plamning limit nuqtasi bo'lsin.

Agar E to'plam y_0 ga intiluvchi $\{y_n\}$ ketma-ketlikdan iborat bo'lsa, $f(x, y)$ funksiyani $[a, b]$ da aniqlangan

$$f_n(x) = f(x, y_n)$$

funksional ketma-ketlik sifatida qarash mumkin. Masalan,

$$f(x, y) = \frac{2xy}{x^2 + y^2}$$

funksiyani $M_0 = \{(x, y) \in R^2 : x \in [0, 1], y \in E = \{1, \frac{1}{2}, \frac{1}{3}, \dots\}\}$ to'plamda qarasaq, u quyidagi

$$f_n(x) = \frac{2xn}{1+n^2x^2}$$

funksional ketma-ketlikka aylanadi.

1- teorema. Agar $y \rightarrow y_0$ da $f(x, y)$ funksiya $\varphi(x)$ ga $[a, b]$ da tekis yaqinlashsa, u holda E to'plamdagi y_0 ga intiluvchi har bir $\{y_n\}$ ketma-ketlikda ($y_n \in E$)

$$f_n(x) = f(x, y_n)$$

funksional ketma-ketlik ham $[a, b]$ da $\varphi(x)$ ga tekis yaqinlashadi.

◀ Aytaylik, $f(x, y)$ funksiya $y \rightarrow y_0$ da $\varphi(x)$ funksiyaga $[a, b]$ da tekis yaqinlashsin. U holda ta'rifga binoan $\forall \varepsilon > 0$, $\exists \delta = \delta(\varepsilon) > 0$, $0 < |y - y_0| < \delta$ tengsizlikni qanoatlantiruvchi ixtiyoriy $y \in E$, $\forall x \in [a, b]$: $|f(x, y) - \varphi(x)| < \varepsilon$ bo'ladi.

Modomiki, $\{y_n\}$ ketma-ketlik y_0 ga intilar ekan,

$$\forall \delta > 0, \exists n_0 \in N, \forall n > n_0: |y_n - y_0| < \delta$$

tengsizlik bajariladi. Demak,

$$\forall \varepsilon > 0, \exists \delta > 0, |y_n - y_0| < \delta, y_n \in E, \forall x \in [a, b]: |f(x, y_n) - \varphi(x)| < \varepsilon,$$

ya'ni,

$$|f_n(x) - \varphi(x)| < \varepsilon$$

bo'ladi. Bu esa $f_n(x)$ funksional ketma-ketlikning $[a, b]$ da $\varphi(x)$ funksiyaga tekis yaqinlashishini bildiradi. ►

Endi $f(x, y)$ funksiyaning limit funksiyaga ega bo'lish va unga tekis yaqinlashishi haqidagi teoremani keltiramiz.

2- teorema. $f(x, y)$ funksiya $y \rightarrow y_0$ da limit funksiya $\varphi(x)$ ga ega bo'lishi va unga tekis yaqinlashishi uchun $\forall \varepsilon > 0$ olinganda ham x ga bog'liq bo'lmagan shunday $\exists \delta = \delta(\varepsilon) > 0$ topilib, $|y - y_0| < \delta$, $|y' - y_0| < \delta$ tengsizliklarni qanoatlantiruvchi ixtiyoriy $y, y' \in E$ hamda $\forall x \in [a, b]$ da

$$|f(x, y) - f(x, y')| < \varepsilon \quad (2)$$

tengsizlikning bajarilishi zarur va yetarli.

◀ **Zarurligi.** Aytaylik, $f(x, y)$ funksiya $y \rightarrow y_0$ da limit funksiya $\varphi(x)$ ga $[a, b]$ da tekis yaqinlashsin. U holda ta'rifga binoan

$$\forall \varepsilon > 0, \exists \delta > 0, |y - y_0| < \delta, \forall y \in E,$$

$$\forall x \in [a, b]: |f(x, y) - \varphi(x)| < \frac{\varepsilon}{2}, \quad (3)$$

jumladan, $|y' - y_0| < \delta$, $y' \in E$ uchun ham

$$|f(x, y') - \varphi(x)| < \frac{\varepsilon}{2} \quad (4)$$

bo'ladi. (3) va (4) munosabatlardan

$$|f(x, y) - f(x, y')| < \varepsilon$$

bo'lishi kelib chiqadi.

Yetarliligi. Aytaylik, (2) shart bajarilsin. Modomiki, har bir tayinlangan $\forall x \in [a, b]$ va $|y - y_0| < \delta$, $|y' - y_0| < \delta$, $y \in E$, $y' \in E$ da

$$|f(x, y) - f(x, y')| < \varepsilon$$

tengsizlik bajarilar ekan, u holda Koshi teoremasiga ko'ra $y \rightarrow y_0$ da $f(x, y)$ funksiya limitga ega bo'ladi. Uni $\varphi(x)$ bilan belgilaylik:

$$\lim_{y \rightarrow y_0} f(x, y) = \varphi(x).$$

Endi y o'zgaruvchining $|y' - y_0| < \delta$ tengsizlikni qanoatlantiradigan qiymatida (2) tengsizlikda $y' \rightarrow y_0$ da limitga o'tib topamiz:

$$|f(x, y) - \varphi(x)| \leq \varepsilon.$$

Bu esa $y \rightarrow y_0$ da $f(x, y)$ funksiyaning $\varphi(x)$ ga $[a, b]$ da tekis yaqinlashishini bildiradi. ►

3- teorema. $f(x, y)$ funksiya uchun quyidagi shartlar bajarilsin:

1) har bir tayin $y \in E$ da $f(x, y)$ funksiya $[a, b]$ da x o'zgaruvchining funksiyasi sifatida uzluksiz;

2) $y \rightarrow y_0$ da $f(x, y)$ funksiya $[a, b]$ da $\varphi(x)$ ga tekis yaqinlashsin.

U holda $\varphi(x)$ funksiya $[a, b]$ da uzluksiz bo'ladi.

◀ E to'plamda y_0 ga intiluvchi ixtiyoriy $\{y_n\}$ ketma-ketlik olib ($y_n \in E, n = 1, 2, \dots, y_n \rightarrow y_0$) $[a, b]$ segmentda aniqlangan ushbu

$$f_n(x) = f(x, y_n)$$

funksional ketma-ketlikni hosil qilamiz. Teoremaning shartlariga ko'ra:

1) $f_n(x)$ funksional ketma-ketlikning har bir hadi $[a, b]$ da uzluksiz bo'ladi;

2) mazkur ma'ruzadagi 2- teoreмага binoan $y \rightarrow y_0$ da $f_n(x)$ funksional ketma-ketlik $\varphi(x)$ funksiyaga $[a, b]$ da tekis yaqinlashadi.

U holda $\varphi(x)$ funksiya $[a, b]$ segmentda uzluksiz bo'ladi (qaralsin, 65- ma'ruza). ►

Mashqlar

1. Ushbu
$$f(x, y) = n \left(\sqrt{x + \frac{1}{n}} - \sqrt{x} \right)$$

funksiyani $M = \{(x, n) \in R^2: x \in (0, \infty), n \in N\}$ to'plamda qarab, uning $n \rightarrow \infty$ dagi limit funksiyasi topilsin.

2. Ushbu
$$f(x, y) = \frac{1}{y} \left(1 - x^y\right) x^{\frac{1}{y}}$$

funksiyani $M = \left\{ (x, y) \in R^2 : x \in \left[\frac{1}{2}, 1 \right], y \in (0, 1] \right\}$ to'plamda qarang. Bu funksiya uchun quyidagi tenglik o'rinli bo'lishi isbotlansin:

$$\lim_{y \rightarrow +0} f(x, y) = 0.$$

3. Aytaylik, $f(x, y)$ funksiya

$$M = \{ (x, y) \in R^2 : x \in [a, b], y \in E \subset R \}$$

to'plamda berilgan va $y_0 \in R$ esa E ning limit nuqtasi bo'lsin. $y \rightarrow y_0$ da $f(x, y)$ funksiyaning $\varphi(x)$ ga $[a, b]$ da tekis yaqinlashishi uchun E to'plamdagi y_0 ga intiluvchi ixtiyoriy $\{y_n\}$ ketma-ketlikda

$$f_n(x) = f(x, y_n)$$

funksional ketma-ketlikning $[a, b]$ da $\varphi(x)$ ga tekis yaqinlashishi zarur va yetarli ekani isbotlansin.

75- ma'ruza

Parametrga bog'liq integrallar

1^o. Parametrga bog'liq integral tushunchasi. Aytaylik, $f(x, y)$ funksiya

$$M = \{ (x, y) \in R^2 : a \leq x \leq b, y \in E \subset R \}$$

to'plamda berilgan bo'lsin. Bu funksiya har bir tayinlangan $y \in E$ da x o'zgaruvchining funksiyasi sifatida $[a, b]$ da integrallanuvchi, ya'ni

$$\int_a^b f(x, y) dx$$

mavjud deylik. Qaralayotgan integralning qiymati tayinlangan y ga bog'liq bo'ladi:

$$J(y) = \int_a^b f(x, y) dx. \quad (1)$$

Masalan, $y \neq 0$ bo'lganda

$$\int_0^1 e^{yx} dx = \frac{e^{yx}}{y} \Big|_0^1 = \frac{e^y - 1}{y},$$

$y = 0$ bo'lganda

$$\int_0^1 e^{0x} dx = 1$$

bo'ladi. Demak,

$$J(y) = \int_0^1 e^{yx} dx = \begin{cases} \frac{e^y - 1}{y}, & \text{agar } y \neq 0 \text{ bo'lsa,} \\ 1, & \text{agar } y = 0 \text{ bo'lsa.} \end{cases}$$

Odatda, (1) integral parametrغا bog'liq integral, y esa *parametr* deyiladi.

Ravshanki, $J(y)$ funksiya (parametrغا bog'liq integral) berilgan $f(x,y)$ funksiya orqali aniqlanib, unga bog'liq bo'ladi.

Parametrغا bog'liq integral mavzusida $f(x,y)$ funksiyaning funksional xossalariga ko'ra $J(y)$ funksiyaning funksional xossalari (limiti, uzluksizligi, differensiallanuvchanligi, integrallanuvchanligi) o'rganiladi.

2°. $J(y)$ funksiyaning limiti. Aytaylik, $f(x,y)$ funksiya

$$M = \{(x, y) \in R^2 : a \leq x \leq b, y \in E \subset R\}$$

to'plamda berilgan bo'lib, $y_0 \in R$ esa E to'plamning limit nuqtasi bo'lsin. Bu funksiya uchun har bir tayin $y \in E$ da

$$J(y) = \int_a^b f(x, y) dx$$

mavjud bo'lsin.

1- teorema. Faraz qilaylik, $f(x,y)$ funksiya quyidagi shartlarni bajarsin:

1) har bir tayin $y \in E$ da $f(x,y)$ funksiya x o'zgaruvchining funksiyasi sifatida $[a,b]$ da uzluksiz;

2) $y \rightarrow y_0$ da $f(x,y)$ funksiya limit funksiya $\varphi(x)$ ga $[a,b]$ da tekis yaqinlashsin.

U holda $y \rightarrow y_0$ da $J(y)$ funksiya limitga ega bo'lib,

$$\lim_{y \rightarrow y_0} J(y) = \int_a^b \varphi(x) dx \quad (2)$$

bo'ladi.

◀ Keltirilgan teorema shartlarining bajarilishidan, 74- ma'ruzadagi 3- teoreмага ko'ra, limit funksiya $\varphi(x)$ ning $[a, b]$ da uzluksiz bo'lishi kelib chiqadi. Demak,

$$\int_a^b \varphi(x) dx$$

integral mavjud.

Ayni paytda, $y \rightarrow y_0$ da $f(x, y)$ funksiyaning $[a, b]$ da $\varphi(x)$ funksiyaga tekis yaqinlashuvchi bo'lishidan, ta'rifga binoan,

$$\forall \varepsilon > 0, \exists \delta > 0, |y - y_0| < \delta, \forall y \in E, \forall x \in [a, b]: |f(x, y) - \varphi(x)| < \frac{\varepsilon}{b-a}$$

bo'lishini topamiz. Ushbu

$$\left| J(y) - \int_a^b \varphi(x) dx \right|$$

ayirmani qaraylik.

Ravshanki, $|y - y_0| < \delta$ tengsizlikni qanoatlantiruvchi ixtiyoriy $y \in E$ uchun

$$\begin{aligned} \left| J(y) - \int_a^b \varphi(x) dx \right| &= \left| \int_a^b f(x, y) dx - \int_a^b \varphi(x) dx \right| \leq \\ &\leq \int_a^b |f(x, y) - \varphi(x)| dx < \frac{\varepsilon}{b-a} \int_a^b dx = \varepsilon \end{aligned}$$

bo'ladi. Keyingi munosabatdan

$$\lim_{y \rightarrow y_0} J(y) = \int_a^b \varphi(x) dx$$

bo'lishi kelib chiqadi. ►

(2) munosabatni quyidagicha

$$\lim_{y \rightarrow y_0} \int_a^b f(x, y) dx = \int_a^b \left[\lim_{y \rightarrow y_0} f(x, y) \right] dx$$

ko'rinishda ham yozish mumkin. Bu integral belgisi ostida limitga o'tish qoidasini ifodalaydi.

3°. $J(y)$ funksiyaning uzluksizligi. $J(y)$ funksiyaning uzluksizligini quyidagi teorema ifodalaydi.

2- teorema. Agar $f(x, y)$ funksiya

$$M_0 = \{(x, y) \in R^2 : a \leq x \leq b, c \leq y \leq d\}$$

to'plamda uzluksiz bo'lsa, $J(y)$ funksiya $[c, d]$ da uzluksiz bo'ladi.

◀ Ixtiyoriy $y_0 \in [c, d]$ va $y_0 + \Delta y \in [c, d]$ nuqtalarni olib, $J(y)$ funksiyaning orttirmasini topamiz:

$$\Delta J(y_0) = J(y_0 + \Delta y) - J(y_0) = \int_a^b [f(x, y_0 + \Delta y) - f(x, y_0)] dx.$$

$f(x, y)$ funksiya M_0 to'plamda tekis uzluksiz. Unda $\forall \varepsilon > 0$ uchun shunday $\delta > 0$ topiladiki, $|\Delta y| < \delta$ bo'lganda, $\forall x \in [a, b]$ uchun

$$|f(x, y_0 + \Delta y) - f(x, y_0)| < \varepsilon$$

bo'ladi. Demak, $|\Delta y| < \delta$ bo'lganda

$$|\Delta J(y_0)| = \left| \int_a^b [f(x, y_0 + \Delta y) - f(x, y_0)] dx \right| < \varepsilon(b - a)$$

bo'ladi. Keyingi munosabatdan

$$\lim_{\Delta y \rightarrow 0} \Delta J(y_0) = 0$$

bo'lishi kelib chiqadi. Bu esa $J(y)$ funksiyaning ixtiyoriy y_0 nuqtada, binobarin, $[c, d]$ da uzluksiz bo'lishini bildiradi. ►

4°. $J(y)$ funksiyani differensiallash. Aytaylik, $f(x, y)$ funksiya M_0 to'plamda berilgan bo'lsin.

3- teorema. Faraz qilaylik, $f(x, y)$ funksiya quyidagi shartlarni bajarsin:

1) har bir tayin $y \in [c, d]$ da $f(x, y)$ funksiya $[a, b]$ da x o'zgaruvchining funksiyasi sifatida uzluksiz;

2) $f(x, y)$ funksiya M_0 to'plamda $f'_y(x, y)$ xususiy hosilaga ega va $f'_y(x, y)$ funksiya M_0 da uzluksiz.

U holda $J(y)$ funksiya $[c, d]$ da hosilaga ega va

$$J'(y) = \int_a^b f'_y(x, y) dx \quad (3)$$

bo'ladi.

◀ $y \in [c, d]$, $y + \Delta y \in [c, d]$ nuqtalarni olib, topamiz:

$$\frac{J(y+\Delta y) - J(y)}{\Delta y} = \int_a^b \frac{f(x, y+\Delta y) - f(x, y)}{\Delta y} dx.$$

Lagranj teoremasiga ko'ra

$$\frac{f(x, y+\Delta y) - f(x, y)}{\Delta y} = f'_y(x, y + \theta \Delta y), \quad (0 < \theta < 1)$$

bo'lib,

$$\frac{J(y+\Delta y) - J(y)}{\Delta y} = \int_a^b f'_y(x, y + \theta \Delta y) dx, \quad (0 < \theta < 1) \quad (4)$$

bo'ladi.

$f'_y(x, y)$ funksiya M_0 to'plamda tekis uzluksiz bo'lganligi sababli $\forall \varepsilon > 0, \exists \delta > 0, |\Delta y| < \delta, \forall x \in [a, b]: |f'_y(x, y + \theta \Delta y) - f'_y(x, y)| < \frac{\varepsilon}{b-a}$ tengsizlik bajariladi. (4) munosobatdan foydalanib

$$\left| \frac{J(y+\Delta y) - J(y)}{\Delta y} - \int_a^b f'_y(x, y) dx \right| \leq \int_a^b |f'_y(x, y + \theta \Delta y) - f'_y(x, y)| dx < \varepsilon$$

bo'lishini topamiz. Demak,

$$\lim_{\Delta y \rightarrow 0} \frac{J(y+\Delta y) - J(y)}{\Delta y} = \int_a^b f'_y(x, y) dx.$$

Bu esa $J'(y) = \int_a^b f'_y(x, y) dx$ ekanini bildiradi. ▶

(3) munosabatni quyidagicha

$$\frac{d}{dy} \int_a^b f(x, y) dx = \int_a^b \frac{d}{dy} f(x, y) dx$$

ko'rinishda ham yozish mumkin. Bu differensiallash amalini integral belgisi ostiga o'tkazish qoidasini ifodalaydi.

5°. $J(y)$ funksiyani integrallash. Faraz qilaylik, $f(x, y)$ funksiya M_0 to'plamda berilgan va uzluksiz bo'lsin. U holda 2- teorema ko'ra

$$J(y) = \int_a^b f(x, y) dx$$

funksiya $[c, d]$ da uzluksiz bo'ladi. Binobarin, bu funksiya $[c, d]$ da integrallanuvchi, ya'ni

$$\int_c^d J(y) dy$$

mavjud bo'ladi.

4- teorema. Agar $f(x, y)$ funksiya M_0 to'plamda uzluksiz bo'lsa, u holda quyidagi ifoda o'rinli bo'ladi:

$$\int_c^d J(y) dy = \int_c^d \left[\int_a^b f(x, y) dx \right] dy = \int_a^b \left[\int_c^d f(x, y) dy \right] dx.$$

◀ $\forall t \in [c, d]$ nuqtani olib, ushbu

$$F(t) = \int_c^t \left[\int_a^b f(x, y) dx \right] dy, \quad \Phi(t) = \int_a^b \left[\int_c^t f(x, y) dy \right] dx$$

funksiyalarni qaraymiz. Ravshanki,

$$F'(t) = \left(\int_c^t \left[\int_a^b f(x, y) dx \right] dy \right)' = \int_a^b f(x, t) dx,$$

$$\Phi'(t) = \left(\int_a^b \left[\int_c^t f(x, y) dy \right] dx \right)' = \int_a^b \left[\int_c^t f(x, y) dy \right]'_t dx = \int_a^b f(x, t) dx.$$

Demak,
$$F'(t) = \Phi'(t) = \int_a^b f(x, t) dx$$

bo'lib, undan

$$F(t) = \Phi(t) + C, \quad (C = \text{const})$$

bo'lishi kelib chiqadi. Agar $t = c$ deyilsa,

$$F(c) = \Phi(c) = 0$$

bo'ladi va keyingi tenglikdan $C = 0$ bo'lishini topamiz. Demak,

$$F(t) = \Phi(t).$$

Xususan, $t = d$ bo'lganda $F(d) = \Phi(d)$ bo'lib,

$$\int_c^d \left[\int_a^b f(x, y) dx \right] dy = \int_a^b \left[\int_c^d f(x, y) dy \right] dx$$

bo'ladi. ►

Mashqlar

1. Ushbu
$$f(x, y) = \frac{1}{y} \left(1 - x^{\frac{1}{y}}\right) x^{\frac{1}{y}}$$

funksiyani
$$\left\{ (x, y) \in \mathbb{R}^2 : x \in \left[\frac{1}{2}, 1\right], y \in (0, 1) \right\}$$

to'plamda qaraylik. Bu funksiya uchun

$$\lim_{y \rightarrow +0} \int_{\frac{1}{2}}^1 f(x, y) dx \neq \int_{\frac{1}{2}}^1 \left(\lim_{y \rightarrow +0} f(x, y) \right) dx$$

bo'lishi isbotlansin.

2. Agar $f(x)$ funksiya $[0, 1]$ segmentda uzluksiz hosilaga ega bo'lsa,

$$J(y) = \int_0^1 f(x) \text{sign} \sin(xy) dx, \quad (y > 0)$$

funksiyaning hosilasi topilsin.

3. Agar $J_0(y) = \frac{1}{\pi} \int_0^{\pi} \cos(y \cos x) dx, \quad (y \in R)$

bo'lsa, u quyidagi $yJ_0''(y) + J_0'(y) + yJ_0(y) = 0$ tenglamani qanoatlantirishi ko'rsatilsin.

76- ma'ruza

Chegaralari o'zgaruvchi parametrga bog'liq integrallar

Faraz qilaylik, $f(x,y)$ funksiya

$$M_0 = \{(x,y) \in R^2 : a \leq x \leq b, \quad c \leq y \leq d\}$$

to'plamda berilgan va har bir tayin $y \in [c,d]$ da $f(x,y)$ funksiya x o'zgaruvchining funksiyasi sifatida $[a,b]$ da integrallanuvchi bo'lsin. $\alpha(y)$ va $\beta(y)$ funksiyalarning har biri $[c,d]$ da berilgan va $\forall y \in [c,d]$ uchun

$$a \leq \alpha(y) \leq \beta(y) \leq b \quad (1)$$

tengsizliklar bajarilsin. Ushbu

$$\int_{\alpha(y)}^{\beta(y)} f(x,y) dx$$

integral, ravshanki, y o'zgaruvchiga bog'liq bo'ladi:

$$J_1(y) = \int_{\alpha(y)}^{\beta(y)} f(x,y) dx. \quad (2)$$

2) integral *chegaralari ham parametrga bog'liq integral* deyiladi.

1°. $J_1(y)$ **funksiyaning uzluksizligi.** $J_1(y)$ funksiyaning uzluksizligini quyidagi teorema ifodalaydi.

1- teorema. Faraz qilaylik, $f(x,y)$ funksiya M_0 to'plamda uzluksiz bo'lib, $\alpha(y)$ va $\beta(y)$ funksiyalar esa $[c,d]$ segmentda uzluksiz bo'lsin. U holda

$$J_1(y) = \int_{\alpha(y)}^{\beta(y)} f(x,y) dx$$

funksiya $[c,d]$ da uzluksiz bo'ladi.

◀ Ixtiyoriy $y_0 \in [c, d]$ nuqtani olaylik. Integralning ma'lum xossalardan foydalanib topamiz:

$$J_1(y) = \int_{\alpha(y)}^{\beta(y)} f(x, y) dx = \int_{\alpha(y)}^{\alpha(y_0)} f(x, y) dx + \int_{\alpha(y_0)}^{\beta(y_0)} f(x, y) dx + \int_{\beta(y_0)}^{\beta(y)} f(x, y) dx + \int_{\beta(y_0)}^{\beta(y)} f(x, y) dx = \int_{\beta(y_0)}^{\beta(y)} f(x, y) dx - \int_{\alpha(y_0)}^{\alpha(y)} f(x, y) dx. \quad (3)$$

Ravshanki,
$$\int_{\alpha(y_0)}^{\beta(y_0)} f(x, y) dx$$

integral chegarasi o'zgaras bo'lgan parametrnga bog'liq integral. Bu funksiya 75- ma'ruzada keltirilgan 2- teoreмага muvofiq y o'zgaruvchining uzluksiz funksiyasi bo'ladi. Demak,

$$y \rightarrow y_0 \text{ da } \int_{\alpha(y_0)}^{\beta(y_0)} f(x, y) dx \rightarrow \int_{\alpha(y_0)}^{\beta(y_0)} f(x, y_0) dx = J_1(y_0) \quad (4)$$

bo'ladi.

$f(x, y)$ funksiya M_0 to'plamda uzluksiz bo'lganligi sababli y shu to'plamda chegaralangan bo'ladi:

$$|f(x, y)| \leq C, \quad (C = \text{const}).$$

Shartga ko'ra $\alpha(y)$ va $\beta(y)$ funksiyalar $[c, d]$ segmentda uzluksiz. Demak:

$$y \rightarrow y_0 \text{ da } \alpha(y) \rightarrow \alpha(y_0), \\ y \rightarrow y_0 \text{ da } \beta(y) \rightarrow \beta(y_0).$$

Endi
$$\left| \int_{\beta(y_0)}^{\beta(y)} f(x, y) dx \right| \leq C |\beta(y) - \beta(y_0)|, \\ \left| \int_{\alpha(y_0)}^{\alpha(y)} f(x, y) dx \right| \leq C |\alpha(y) - \alpha(y_0)|$$

munosabatlardan

$$y \rightarrow y_0 \text{ da } \int_{\beta(y_0)}^{\beta(y)} f(x, y) dx \rightarrow 0, \quad y \rightarrow y_0 \text{ da } \int_{\alpha(y_0)}^{\beta(y)} f(x, y) dx \rightarrow 0$$

bo'lishini topamiz.

(3) tenglikda, $y \rightarrow y_0$ da limitga o'tish va unda (4) va (5) munosabatlarni hisobga olish natijasida

$$y \rightarrow y_0 \text{ da } J_1(y) \rightarrow J_1(y_0)$$

bo'lishi kelib chiqadi. Demak, $J_1(y)$ funksiya $[c, d]$ da uzluksiz. ►

2°. $J_1(y)$ funksiyani differensiallash. Faraz qilaylik, $f(x, y)$ funksiya

$$M_0 = \{(x, y) \in R^2 : a \leq x \leq b, c \leq y \leq d\}$$

to'plamda, $\alpha(y)$ va $\beta(y)$ funksiyalar esa $[c, d]$ segmentda berilgan bo'lib, $\alpha(y)$, $\beta(y)$ funksiyalar (1) shartni bajarsin, ya'ni $\forall y \in [c, d]$ uchun

$$a \leq \alpha(y) \leq \beta(y) \leq b$$

bo'lsin.

2- teorema. Aytaylik, $f(x, y)$, $\alpha(y)$ va $\beta(y)$ funksiyalar quyidagi shartlarni bajarsin:

- 1) $f(x, y)$ funksiya M_0 to'plamda uzluksiz;
- 2) $f(x, y)$ funksiya M_0 to'plamda uzluksiz $f'_y(x, y)$ xususiy hosilaga ega;
- 3) $\alpha(y)$ va $\beta(y)$ funksiyalar $[c, d]$ da $\alpha'(y)$ va $\beta'(y)$ hosilalarga ega. U holda

$$J_1(y) = \int_{\alpha(y)}^{\beta(y)} f(x, y) dx$$

funksiya $[c, d]$ segmentda $J'_1(y)$ hosilaga ega bo'lib,

$$J'_1(y) = \int_{\alpha(y)}^{\beta(y)} f'_y(x, y) dx + \beta'(y) f(\beta(y), y) - \alpha'(y) f(\alpha(y), y)$$

bo'ladi.

◀ $y_0 \in [c, d]$, $y_0 + \Delta y \in [c, d]$ nuqtalarni olib, topamiz:

$$\frac{J_1(y_0 + \Delta y) - J_1(y_0)}{\Delta y} = \frac{1}{\Delta y} \left[\int_{\alpha(y_0 + \Delta y)}^{\beta(y_0 + \Delta y)} f(x, y_0 + \Delta y) dx - \int_{\alpha(y_0)}^{\beta(y_0)} f(x, y_0) dx \right].$$

Agar

$$\begin{aligned} \int_{\alpha(y_0 + \Delta y)}^{\beta(y_0 + \Delta y)} f(x, y_0 + \Delta y) dx &= \int_{\alpha(y_0)}^{\beta(y_0)} f(x, y_0 + \Delta y) dx + \\ &+ \int_{\beta(y_0)}^{\beta(y_0 + \Delta y)} f(x, y_0 + \Delta y) dx - \int_{\alpha(y_0)}^{\alpha(y_0 + \Delta y)} f(x, y_0 + \Delta y) dx \end{aligned}$$

bo'lishini e'tiborga olsak, u holda

$$\begin{aligned} \frac{J_1(y_0 + \Delta y) - J_1(y_0)}{\Delta y} &= \int_{\alpha(y_0)}^{\beta(y_0)} \frac{[f(x, y_0 + \Delta y) - f(x, y_0)]}{\Delta y} dx + \\ &+ \frac{1}{\Delta y} \int_{\beta(y_0)}^{\beta(y_0 + \Delta y)} f(x, y_0 + \Delta y) dx - \frac{1}{\Delta y} \int_{\alpha(y_0)}^{\alpha(y_0 + \Delta y)} f(x, y_0 + \Delta y) dx \quad (6) \end{aligned}$$

bo'lishi kelib chiqadi. 75- ma'ruzadagi 1- teoremda ko'ra

$$\begin{aligned} \lim_{\Delta y \rightarrow 0} \int_{\alpha(y_0)}^{\beta(y_0)} \frac{[f(x, y_0 + \Delta y) - f(x, y_0)]}{\Delta y} dx &= \\ = \int_{\alpha(y_0)}^{\beta(y_0)} \lim_{\Delta y \rightarrow 0} \frac{[f(x, y_0 + \Delta y) - f(x, y_0)]}{\Delta y} dx &= \int_{\alpha(y_0)}^{\beta(y_0)} f'_y(x, y_0) dx \quad (7) \end{aligned}$$

bo'ladi. O' rta qiymat haqidagi teoremdan foydalanib, topamiz:

$$\begin{aligned} \int_{\alpha(y_0)}^{\beta(y_0 + \Delta y)} f(x, y_0 + \Delta y) dx &= f(x', y_0 + \Delta y) [\beta(y_0 + \Delta y) - \beta(y_0)], \\ \int_{\alpha(y_0)}^{\alpha(y_0 + \Delta y)} f(x, y_0 + \Delta y) dx &= f(x'', y_0 + \Delta y) [\alpha(y_0 + \Delta y) - \alpha(y_0)]. \end{aligned}$$

Bunda x' nuqta $\beta(y_0)$, $\beta(y_0 + \Delta y)$ nuqtalar orasida, x'' esa $\alpha(y_0)$, $\alpha(y_0 + \Delta y)$ nuqtalar orasida joylashgan. $y \rightarrow y_0$ da limitga o'tishi bilan quyidagi tengliklarga kelamiz:

$$\begin{aligned} \lim_{\Delta y \rightarrow 0} \frac{1}{\Delta y} \int_{\beta(y_0)}^{\beta(y_0 + \Delta y)} f(x, y_0 + \Delta y) dx &= \\ = \lim_{\Delta y \rightarrow 0} f(x', y_0 + \Delta y) \frac{[\beta(y_0 + \Delta y) - \beta(y_0)]}{\Delta y} &= f(\beta(y_0), y_0) \beta'(y_0), \\ \lim_{\Delta y \rightarrow 0} \frac{1}{\Delta y} \int_{\alpha(y_0)}^{\alpha(y_0 + \Delta y)} f(x, y_0 + \Delta y) dx &= \quad (8) \\ = \lim_{\Delta y \rightarrow 0} f(x'', y_0 + \Delta y) \frac{[\alpha(y_0 + \Delta y) - \alpha(y_0)]}{\Delta y} &= f(\alpha(y_0), y_0) \alpha'(y_0). \end{aligned}$$

Yuqoridagi (6) munosabatda $\Delta y \rightarrow 0$ da limitga o'tib, (7) va (8) tengliklarni e'tiborga olib, ushbu

$$\begin{aligned} \lim_{\Delta y \rightarrow 0} \frac{J_1(y_0 + \Delta y) - J_1(y_0)}{\Delta y} &= \int_{\alpha(y_0)}^{\beta(y_0)} f'_y(x, y_0) dx + \\ &+ f(\beta(y_0), y_0) \beta'(y_0) - f(\alpha(y_0), y_0) \alpha'(y_0) \end{aligned}$$

tenglikka kelamiz. Demak,

$$J'_1(y_0) = \int_{\alpha(y_0)}^{\beta(y_0)} f'_y(x, y_0) dx + f(\beta(y_0), y_0) \beta'(y_0) - f(\alpha(y_0), y_0) \alpha'(y_0). \blacktriangleright$$

Misol. Ushbu $J_1(y) = \int_0^1 e^x |y - x| dx$ funksiyaning hosilasi topilsin.

◀ Aytaylik, $y \in (-\infty, 0)$ bo'lsin. Bu holda

$$J_1(y) = -y \int_0^1 e^x dx + \int_0^1 x e^x dx = y(1 - e) + [e - (e - 1)] = (1 - e)y + 1$$

bo'lib, $J'_1(y) = 1 - e$ ga ega bo'lamiz.

Aytaylik, $y \in (0,1)$ bo'lsin. Bu holda

$$J_1(y) = \int_0^y (y-x)e^x dx - \int_y^1 (y-x)e^x dx = \int_0^y ye^x dx - \int_0^y xe^x dx - \int_y^1 ye^x dx + \int_y^1 xe^x dx = 2e^y - (e+1)y - 1$$

bo'lib, $J_1'(y) = 2e^y - e - 1$ bo'ladi.

Aytaylik, $y \in [1, +\infty)$ bo'lsin. Bu holda

$$J_1(y) = y \int_0^1 e^x dx - \int_0^1 xe^x dx = y(e-1) - [e - (e-1)] = (e-1)y - 1$$

va $J_1'(y) = e - 1$ bo'ladi. Demak,

$$J_1'(y) = \begin{cases} 1 - e, & \text{agar } -\infty < y \leq 0, \\ 2e^y - e - 1, & \text{agar } 0 < y < 1, \\ e - 1, & \text{agar } 1 \leq y < +\infty \end{cases}$$

bo'ladi. ►

Mashqlar

1. Agar $J_1(y) = \int_0^y \frac{e^x dx}{\sqrt{y-x}}$, ($0 \leq x \leq 1$)

bo'lsa, u holda $0 < y < 1$ uchun

$$J_1'(y) = \frac{1}{\sqrt{y}} + \int_0^y \frac{e^x dx}{\sqrt{y-x}}$$

bo'lishi isbotlansin.

2. Agar $J_1(y) = \int_y^{1+y} \frac{dx}{1+x^2+y^2}$ bo'lsa, $\lim_{y \rightarrow 0} J_1(y)$ topilsin.

77- ma'ruza

Parametrga bog'liq xosmas integrallar

1°. Parametrga bog'liq xosmas integral tushunchasi. Faraz qilaylik, $f(x,y)$ funksiya

$$M = \{(x,y) \in R^2 : x \in [a, +\infty), y \in E \subset R\}$$

to'plamda berilgan bo'lsin. Bu funksiya har bir tayin $y \in E$ da x o'zgaruvchining funksiyasi sifatida $[a, +\infty)$ da integrallanuvchi, ya'ni

$$\int_a^{+\infty} f(x,y) dx$$

xosmas integral yaqinlashuvchi. Ravshanki, integralning qiymati y o'zgaruvchiga bog'liq bo'ladi:

$$F(y) = \int_a^{+\infty} f(x,y) dx. \quad (1)$$

Masalan, $y > 1$ bo'lganda

$$\int_1^{+\infty} \frac{dx}{x^y} = \lim_{t \rightarrow \infty} \int_1^t \frac{dx}{x^y} = \lim_{t \rightarrow \infty} \frac{1}{1-y} (t^{1-y} - 1) = \frac{1}{y-1}$$

bo'ladi. Demak, bu holda

$$F(y) = \frac{1}{y-1}$$

ifoda kelib chiqadi.

(1) integral parametrga bog'liq chegarasi cheksiz xosmas integral, y esa parametr deyiladi.

Xuddi shunga o'xshash

$$F_1(y) = \int_{-\infty}^a f(x,y) dx, \quad F_2(y) = \int_{-\infty}^{+\infty} f(x,y) dx$$

parametrga bog'liq xosmas integrallar tushunchalari kiritiladi.

Aytaylik, $f(x,y)$ funksiya

$$M = \{(x,y) \in R^2 : x \in [a,b), y \in E \subset R\}$$

to'plamda berilgan bo'lsin. Bu funksiya har bir tayin $y \in E$ da x o'zgaruvchining funksiyasi sifatida qaralganda uning uchun b maxsus nuqta bo'lib, u $[a, b]$ da integrallanuvchi, ya'ni

$$\int_a^b f(x, y) dx$$

xosmas integral yaqinlashuvchi bo'lsin. Ravshanki, bu holda ham integralning qiymati y o'zgaruvchiga bog'liq bo'ladi:

$$\Phi(y) = \int_a^b f(x, y) dx. \quad (2)$$

Masalan, $0 < y < 1$ bo'lganda

$$\int_1^2 \frac{dx}{(2-x)^y} = \lim_{t \rightarrow 2-0} \int_1^t (2-x)^{-y} dx = \lim_{t \rightarrow 2-0} \frac{1}{y-1} [(2-t)^{1-y} - 1] = \frac{1}{1-y}$$

bo'ladi. Demak, bu holda

$$\Phi(y) = \frac{1}{1-y}$$

bo'ladi.

(2) integral parametrga bog'liq, chegaralanmagan funksiyaning xosmas integrali, y esa parametr deyiladi.

Umumiy holda, parametrga bog'liq, chegaralanmagan funksiyaning chegarasi cheksiz integrali tushunchasi ham yuqoridagidek kiritiladi.

Parametrga bog'liq xosmas integrallarning funksional xossalari (limiti, uzluksizligi, differensiallanishi, integrallanishi)ni

$$F(y) = \int_a^{+\infty} f(x, y) dx$$

integral uchun keltirish bilan kifoyalanamiz.

2°. Integralning tekis yaqinlashishi. Aytaylik, $f(x, y)$ funksiya

$$M = \{(x, y) \in R^2 : x \in [a, +\infty), y \in E \subset R\}$$

to'plamda berilgan bo'lib, har bir tayin $y \in E$ da

$$F(y) = \int_a^{+\infty} f(x, y) dx$$

xosmas integral yaqinlashuvchi bo'lsin. Ta'rifga binoan

$$F(y) = \int_a^{+\infty} f(x, y) dx = \lim_{t \rightarrow +\infty} \int_a^t f(x, y) dx, \quad (a < t < \infty)$$

bo'ladi. Natijada berilgan $f(x, y)$ funksiya yordamida

$$G(y, t) = \int_a^t f(x, y) dx, \quad (a < t < \infty)$$

$$F(y) = \int_a^{+\infty} f(x, y) dx$$

funksiyalar yuzaga keladi va

$$\lim_{t \rightarrow +\infty} G(y, t) = F(y), \quad (y \in E)$$

munosabat bajariladi.

Demak, $G(y, t)$ funksiya $t \rightarrow +\infty$ da limit funksiya $F(y)$ ga ega bo'ladi.

I-ta'rif. Agar $t \rightarrow +\infty$ da $G(y, t)$ funksiya limit funksiya $F(y)$ ga E to'plamda tekis yaqinlashsa,

$$F(y) = \int_a^{+\infty} f(x, y) dx$$

integral E to'plamda tekis yaqinlashuvchi deyiladi.

Integralning E to'plamda tekis yaqinlashuvchanligini quyidagicha anglash lozim:

1) har bir tayin $y \in E$ da $\int_a^{+\infty} f(x, y) dx$ xosmas integral yaqin-

lashuvchi;

2) $\forall \varepsilon > 0$ olinganda ham shunday $\delta = \delta(\varepsilon) > 0$ topiladiki, bunda $\forall t > \delta$ va $\forall y \in E$ uchun

$$\left| \int_t^{+\infty} f(x, y) dx \right| < \varepsilon$$

tengsizlik bajariladi.

1- misol. Ushbu $\int_0^{+\infty} e^{-x} \cos xy \, dx$

xosmas integralning $(-\infty, +\infty)$ da tekis yaqinlashuvchi ekani ko'rsatilsin.

◀ Har bir tayin $y \in (-\infty, +\infty)$ da qaralayotgan xosmas integralning yaqinlashuvchi ekanligi ravshan.

$\forall \varepsilon > 0$ ga ko'ra $\delta = \ln \frac{2}{\varepsilon}$ deyilsa, u holda $\forall t > \delta$ va $\forall y \in (-\infty, +\infty)$ uchun

$$\left| \int_t^{+\infty} e^{-x} \cos xy \, dx \right| \leq \int_t^{+\infty} e^{-x} \, dx = e^{-t} \leq e^{-\delta} = e^{-\ln \frac{2}{\varepsilon}} = \frac{\varepsilon}{2} < \varepsilon$$

bo'ladi. Demak, berilgan integral $(-\infty, +\infty)$ da tekis yaqinlashuvchi. ▶

2- ta'rif. Agar $t \rightarrow +\infty$ da $G(y, t)$ funksiya limit funksiya $F(y)$ ga E to'plamda tekis yaqinlashmasa,

$$F(y) = \int_a^{+\infty} f(x, y) \, dx$$

integral E to'plamda tekis yaqinlashmaydi deyiladi.

Integral E to'plamda yaqinlashuvchi, ammo u shu to'plamda tekis yaqinlashmaydi degani quyidagini anglatadi:

1) har bir tayin $y \in E$ da $\int_a^{+\infty} f(x, y) \, dx$ xosmas integral yaqinlashuvchi;

2) $\forall \delta > 0$ olinganda ham shunday $\varepsilon_0 > 0$, $y_0 \in E$ va $t_1 > \delta$ bo'lgan $t_1 \in [a, +\infty)$ topiladiki, bunda quyidagi ifoda o'rinli bo'ladi:

$$\left| \int_{t_1}^{+\infty} f(x, y_1) \, dx \right| \geq \varepsilon_0.$$

2- misol. Ushbu

$$\int_0^{+\infty} ye^{-xy} \, dx$$

xosmas integralning $(0, +\infty)$ da tekis yaqinlashmasligi ko'rsatilsin.

◀ Ravshanki,

$$\int_0^{+\infty} ye^{-xy} dx = \lim_{t \rightarrow +\infty} \int_0^t ye^{-xy} dx = \lim_{t \rightarrow +\infty} (1 - e^{-ty}) = 1.$$

Demak, berilgan xosmas integral yaqinlashuvchi. Aytaylik, $y \in E = (0, +\infty)$ bo'lsin. Ixtiyoriy musbat δ sonni olaylik. Agar $\varepsilon_0 = \frac{1}{3}$, $t_0 > \delta$ va $y_0 = \frac{1}{t_0}$ deb olsak, u holda

$$\left| \int_{t_0}^{+\infty} y_0 e^{-xy_0} dx \right| = e^{-t_0 y_0} = e^{-1} > \frac{1}{3} = \varepsilon_0$$

bo'ladi. Bu esa $\int_0^{+\infty} ye^{-xy} dx$ integral $E = (0, +\infty)$ da tekis yaqinlashmasligini bildiradi. ▶

Yuqoridagi
$$F(y) = \int_a^{+\infty} f(x, y) dx$$

parametrga bog'liq xosmas integralning parametr y bo'yicha E to'plamda tekis yaqinlashishini quyidagicha ham ta'riflasha bo'ladi.

3-ta'rif. Agar

$$\lim_{t \rightarrow +\infty} \sup_{y \in E} \left| F(y) - \int_a^t f(x, y) dx \right| = \lim_{t \rightarrow +\infty} \sup_{y \in E} \left| \int_t^{+\infty} f(x, y) dx \right| = 0$$

($a < t < +\infty$) bo'lsa,

$$F(y) = \int_a^{+\infty} f(x, y) dx$$

xosmas integral to'plamda tekis yaqinlashuvchi deyiladi.

3-misol. Ushbu $F(y) = \int_1^{+\infty} \frac{dx}{x^y}$ xosmas integralning $E = [2, +\infty)$

to'plamda tekis yaqinlashuvchi ekani ko'rsatilsin.

◀ Ravshanki, $1 < t < +\infty$ uchun

$$0 \leq \sup_{y \in [2, +\infty)} \left| \int_t^{+\infty} \frac{dx}{x^y} \right| = \sup_{y \in [2, +\infty)} \frac{1}{(y-1)t^{y-1}} \leq \frac{1}{t}$$

bo'lib,

$$\lim_{t \rightarrow +\infty} \sup_{y \in [2, +\infty)} \left| \int_t^{+\infty} \frac{dx}{x^y} \right| = 0$$

bo'ladi. Demak, berilgan xosmas integral $E = [2, +\infty)$ to'plamda tekis yaqinlashuvchi. ►

Endi integralning tekis yaqinlashishini ifodalovchi teoremani keltiramiz.

1- teorema. Ushbu $F(y) = \int_a^{+\infty} f(x, y) dx$

integralning E to'plamda tekis yaqinlashuvchi bo'lishi uchun $\forall \varepsilon > 0$ olinganda ham y ga bog'liq bo'lmagan shunday $\delta = \delta(\varepsilon) > 0$ topilib, $t' > \delta$, $t'' > \delta$ tengsizliklarni qanoatlantiruvchi $\forall t', t''$ va $\forall y \in E$ da

$$\left| \int_{t'}^{t''} f(x, y) dx \right| < \varepsilon$$

tengsizlikning bajarilishi zarur va yetarli.

Bu teoremaning isboti ravshan.

3°. Parametrga bog'liq xosmas integrallarning parametr bo'yicha tekis yaqinlashish alomatlari.

2- teorema. (Veyershtross alomati.) Aytaylik, $f(x, y)$ funksiya

$$M = \{(x, y) \in R^2 : x \in [a, +\infty), y \in E \subset R\}$$

to'plamda berilgan va har bir tayin $y \in E$ da $f(x, y)$ funksiya $[a, +\infty)$ da integrallanuvchi bo'lsin.

Agar $[a, +\infty)$ da aniqlangan shunday $\varphi(x)$ funksiya topilsaki,

1) $\forall x \in [a, +\infty), \forall y \in E$ uchun $|f(x, y)| \leq \varphi(x)$ bo'lsa,

2) ushbu $\int_a^{+\infty} \varphi(x) dx$ xosmas integral yaqinlashuvchi bo'lsa, u holda

$$F(y) = \int_a^{+\infty} f(x, y) dx$$

integral E to'plamda tekis yaqinlashuvchi bo'ladi.

◀ Modomiki, $\int_a^{+\infty} \varphi(x) dx$ yaqinlashuvchi ekan, u holda $\forall \varepsilon > 0$ olinganda ham shunday $\delta = \delta(\varepsilon) > 0$ topiladiki, $t' > \delta$, $t'' > \delta$ bo'lganda

$$\left| \int_{t'}^{t''} f(x, y) dx \right| < \varepsilon$$

tengsizlik bajariladi. Ayni paytda,

$$\left| \int_{t'}^{t''} f(x, y) dx \right| \leq \int_{t'}^{t''} |f(x, y)| dx \leq \int_{t'}^{t''} \varphi(x) dx, \quad (t' < t'')$$

bo'lganligi sababli

$$\left| \int_{t'}^{t''} f(x, y) dx \right| < \varepsilon$$

bo'ladi. Yuqorida keltirilgan 1- teoreмага muvofiq

$$F(y) = \int_a^{+\infty} f(x, y) dx$$

integral E to'plamda tekis yaqinlashuvchi bo'ladi. ▶

4- misol. Ushbu $\int_0^{+\infty} \frac{\cos xy}{1+x^2} dx$, ($y \in E = (-\infty, +\infty)$)

integralning tekis yaqinlashuvchi ekani ko'rsatilsin.

◀ Ravshanki, $\forall x \in [0, +\infty)$ va $\forall y \in (-\infty, +\infty)$ uchun

$$|f(x, y)| = \left| \frac{\cos xy}{1+x^2} \right| \leq \frac{1}{1+x^2}$$

bo'ladi. Ayni paytda,

$$\int_0^{+\infty} \frac{1}{1+x^2} dx$$

xosmas integral yaqinlashuvchi bo'lganligi sababli Veyershtrass alomatiga ko'ra berilgan integral $E = (-\infty, +\infty)$ da tekis yaqinlashuvchi bo'ladi. ►

Integrallarning tekis yaqinlashishini aniqlashda ko'p foydalaniladigan Abel hamda Dirixle alomatlarini isbotsiz keltiramiz.

3- teorema. (Abel alomati.) $f(x,y)$ va $g(x,y)$ funksiyalar

$$M = \{(x,y) \in R^2 : x \in [a, +\infty), y \in E \subset R\}$$

to'plamda berilgan bo'lib, quyidagi shartlar bajarilsin:

- 1) har bir tayin $y \in E$ da $g(x,y)$ funksiya $[a, +\infty)$ da monoton bo'lsin;
- 2) $\forall (x,y) \in M$ uchun $|g(x,y)| \leq c$, ($c = \text{const}$) bo'lsin;

- 3) ushbu $\int_a^{+\infty} f(x,y) dx$ integral E to'plamda tekis yaqinlashuvchi

bo'lsin. U holda

$$\int_a^{+\infty} f(x,y) g(x,y) dx$$

integral E to'plamda tekis yaqinlashuvchi bo'ladi.

4- teorema. (Dirixle alomati.) $f(x,y)$ va $g(x,y)$ funksiyalar M to'plamda berilgan bo'lib, quyidagi shartlar bajarilsin:

- 1) $\forall t \geq a$ hamda $\forall t \in E$ da

$$\left| \int_a^t f(x,y) dx \right| \leq c, \quad (c = \text{const})$$

tengsizlik bajarilsin;

2) har bir tayin $y \in E$ da $g(x,y)$ funksiya limit funksiya $\varphi(x)=0$ ga tekis yaqinlashsin. U holda

$$\int_a^{+\infty} f(x,y) g(x,y) dx$$

integral E to'plamda tekis yaqinlashuvchi bo'ladi.

5- misol. Ushbu

$$\int_0^{+\infty} \frac{\sin xy}{x} dx, \quad (y \in E = [1, 2])$$

integral tekis yaqinlashuvchanlikka tekshirilsin.

◀ Berilgan integralda

$$f(x, y) = \sin xy, \quad g(x, y) = \frac{1}{x}$$

deyilsa, u holda

1) $\forall t > 0, \forall y \in [1, 2]$ uchun

$$\left| \int_0^t f(x, y) dx \right| = \left| \int_0^t \sin xy dx \right| = \left| \frac{1 - \cos ty}{y} \right| \leq 2,$$

2) $x \rightarrow +\infty$ da $g(x, y) = \frac{1}{x}$ funksiya $E = [1, 2]$ da nolga tekis yaqinlashuvchi.

Dirixle alomatiga ko'ra berilgan integral $E = [1, 2]$ da tekis yaqinlashuvchi bo'ladi. ▶

Mashqlar

1. Ushbu $\int_0^{+\infty} \frac{y \cos xy^2 dx}{y+x^y}$ integralning $E = [2, 10]$ to'plamda tekis yaqinlashishi isbotlansin.

2. Ushbu $\int_0^{+\infty} \frac{dx}{1+x^y}$, ($y > 1$) integral tekis yaqinlashishga tekshirilsin.

3. Aytaylik, $f(x)$ funksiya R da uzluksiz bo'lib, $\forall x \in R$ da $f(x) \geq 0$ bo'lsin. Ushbu

$$\int_0^{+\infty} f(y-x) dx, \quad \int_{-\infty}^0 f(y-x) dx$$

integrallarning y parametr bo'yicha ixtiyoriy chekli $[a, b] \subset R$ segmentda tekis yaqinlashuvchi bo'lishi isbotlansin.

78- ma'ruza

Parametrga bog'liq xosmas integrallarning funksional xossalari

Ushbu ma'ruzada parametrga bog'liq xosmas integral

$$F(y) = \int_a^{+\infty} f(x, y) dx$$

ning limiti, uzluksizligi, differensiallanishi hamda integrallanishi masalalarini bayon etamiz.

1°. $F(y)$ funksiyaning limiti. Aytaylik, $f(x, y)$ funksiya

$$M = \{(x, y) \in R^2 : x \in [a, +\infty), y \in E \subset R\}$$

to'plamda berilgan, $y_0 \in R$ esa E to'plamning limit nuqtasi bo'lsin.

1- teorema. $f(x, y)$ funksiya quyidagi shartlarni bajarsin:

1) har bir tayin $y \in E$ da $f(x, y)$ funksiya x o'zgaruvchining funksiyasi sifatida $[a, +\infty)$ da uzluksiz;

2) $y \rightarrow y_0$ da $f(x, y)$ funksiya ixtiyoriy $[a, t]$ da ($a < t < \infty$) limit funksiya $\varphi(x)$ ga tekis yaqinlashsin;

3) ushbu $F(y) = \int_a^{+\infty} f(x, y) dx$ integral E to'plamda tekis yaqinlashuvchi bo'lsin. U holda $y \rightarrow y_0$ da $F(y)$ funksiya limitga ega va

$$\lim_{y \rightarrow y_0} F(y) = \int_a^{+\infty} \varphi(x) dx$$

bo'ladi.

◀ Teoremaning 1- va 2- shartlarining bajarilishidan $\varphi(x)$ funksiyaning $[a, +\infty)$ da uzluksiz bo'lishini topamiz. Binobarin, $\varphi(x)$ ixtiyoriy $[a, t]$ da ($a < t < \infty$) integrallanuvchi bo'ladi. Modomiki,

$$F(y) = \int_a^{+\infty} f(x, y) dx$$

integral E to'plamda tekis yaqinlashuvchi ekan, u holda 77- ma'ruzadagi 1- teoreмага ko'ra

$\forall \varepsilon > 0, \exists \delta = \delta(\varepsilon) > 0, t' > \delta, t'' > \delta, \forall t', t'', \forall y \in E :$

$$\left| \int_{t'}^{t''} f(x, y) dx \right| < \varepsilon$$

bo'ladi. Keyingi tengsizlikda, $y \rightarrow y_0$ da limitga o'tsak, u holda

$$\left| \int_{t'}^{t''} \varphi(x) dx \right| \leq \varepsilon$$

tengsizlik hosil bo'ladi. Bundan $\varphi(x)$ funksiyaning $[a, +\infty)$ da integ-rallanuvchanligi kelib chiqadi. Ushbu

$$\left| \int_a^{+\infty} f(x, y) dx - \int_a^{+\infty} \varphi(x) dx \right|$$

ayirmani qaraymiz. Uning uchun quyidagi tengsizlik bajariladi:

$$\begin{aligned} & \left| \int_a^{+\infty} f(x, y) dx - \int_a^{+\infty} \varphi(x) dx \right| \leq \\ & \leq \int_a^t |f(x, y) - \varphi(x)| dx + \left| \int_t^{+\infty} f(x, y) dx \right| + \left| \int_t^{+\infty} \varphi(x) dx \right|, \quad (a < t < \infty). \quad (1) \end{aligned}$$

Bu tengsizlikning o'ng tomonidagi qo'shiluvchilarni baholaymiz.

$\int_a^{+\infty} f(x, y) dx$ integral E to'plamda tekis yaqinlashuvchi bo'lganligi sababli,

$\forall \varepsilon > 0, \exists \delta_1 = \delta_1(\varepsilon) > 0, \forall t > \delta_1, \forall y \in E :$

$$\left| \int_t^{+\infty} f(x, y) dx \right| < \frac{\varepsilon}{3} \quad (2)$$

bo'ladi.

$$\int_a^{+\infty} \varphi(x) dx$$

integral yaqinlashuvchi bo'lganligi sababli

$$\forall \varepsilon > 0, \exists \delta_2 = \delta_2(\varepsilon) > 0, \quad \forall t > \delta_2: \left| \int_t^{+\infty} \varphi(x) dx \right| < \frac{\varepsilon}{3} \quad (3)$$

ifodaga ega bo'lamiz.

Ravshanki, $\forall t > \delta_0$ ($\delta_0 = \max(\delta_1, \delta_2)$) da (2) va (3) tensizliklar bir yo'la bajariladi. Funktsiya $f(x, y)$ $y \rightarrow y_0$ da $[a, t]$ segmentda ($t > \delta_0$) limit funksiya $\varphi(x)$ ga tekis yaqinlashuvchi bo'lganligi sababli

$$\forall \varepsilon > 0, \exists \delta' = \delta'(\varepsilon) > 0, \quad |y - y_0| < \delta', \quad \forall y \in E, \quad \forall x \in [a, t], \quad (a < t < \infty)$$

$$|f(x, y) - \varphi(x)| < \frac{\varepsilon}{3(t-a)} \quad (4)$$

bo'ladi. (1), (2), (3) va (4) munosabatlardan

$$\left| \int_a^{+\infty} f(x, y) dx - \int_a^{+\infty} \varphi(x) dx \right| < \varepsilon$$

bo'lishi kelib chiqadi. Demak

$$\lim_{y \rightarrow y_0} F(y) = \lim_{y \rightarrow y_0} \int_a^{+\infty} f(x, y) dx = \int_a^{+\infty} \varphi(x) dx. \quad \blacktriangleright$$

Keyingi tenglikni quyidagicha ham yozish mumkin:

$$\lim_{y \rightarrow y_0} \int_a^{+\infty} f(x, y) dx = \int_a^{+\infty} \left[\lim_{y \rightarrow y_0} f(x, y) \right] dx.$$

1- misol. Ushbu $\lim_{y \rightarrow +0} \int_a^{+\infty} e^{-xy} \frac{\sin x}{x} dx = \int_a^{+\infty} \frac{\sin x}{x} dx$ tenglik isbot-

lansin.

◀ Agar $\varphi(x) = \frac{\sin x}{x}$ funksiyaning $x=0$ nuqtadagi qiymatini $\varphi(0)=1$ deb olinsa, u holda

$$f(x, y) = e^{-xy} \frac{\sin x}{x}$$

funksiya $\{(x, y) \in R^2 : x \in [0, +\infty), y \in [0, +\infty)\}$ to'plamda uzluksiz bo'ladi.

Ravshanki, har bir tayin $y \in [0, +\infty)$ da $f(x, y)$ funksiya x o'zgaruvchining funksiyasi sifatida $[0, +\infty)$ da uzluksiz bo'lib, $y \rightarrow +\infty$ da bu funksiya ixtiyoriy $[0, t]$ da ($0 < t < \infty$) $\varphi(x) = \frac{\sin x}{x}$ funksiyaga tekis yaqinlashadi. Endi

$$\int_0^{+\infty} e^{-xy} \frac{\sin x}{x} dx$$

xosmas integralni parametr y bo'yicha $[0, +\infty)$ da tekis yaqinlashuvchi bo'lishini ko'rsatamiz.

Agar 77- ma'ruzada keltirilgan Abel alomatida $f(x, y)$ funksiya sifatida $\frac{\sin x}{x}$; $g(x, y)$ funksiya sifatida e^{-xy} funksiyalar olinsa, ular uchun Abel alomati barcha shartlarining o'rinli bo'lishini ko'rsatish qiyin emas. Demak, alomatga ko'ra

$$\int_0^{+\infty} e^{-xy} \frac{\sin x}{x} dx$$

integral tekis yaqinlashuvchi.

Yuqorida keltirilgan 1- teorema binoan

$$\lim_{y \rightarrow +0} \int_0^{+\infty} e^{-xy} \frac{\sin x}{x} dx = \int_0^{+\infty} \left(\lim_{y \rightarrow +0} e^{-xy} \frac{\sin x}{x} \right) dx$$

bo'lib, undan $\lim_{y \rightarrow +0} \int_0^{+\infty} e^{-xy} \frac{\sin x}{x} dx = \int_0^{+\infty} \frac{\sin x}{x} dx$ bo'lishi kelib chiqadi. ►

2°. $F(y)$ funksiyaning uzluksizligi. Aytaylik, $f(x, y)$ funksiya

$$M_0 = \{(x, y) \in R^2 : x \in [a, +\infty), y \in [c, d]\}$$

to'plamda berilgan bo'lsin.

2- teorema. Agar $f(x, y)$ funksiya M_0 to'plamda uzluksiz bo'lib,

$$F(y) = \int_a^{+\infty} f(x, y) dx$$

integral $[c, d]$ da tekis yaqinlashuvchi bo'lsa, u holda $F(y)$ funksiya $[c, d]$ da uzluksiz bo'ladi.

◀ Ixtiyoriy $y_0 \in [c, d]$, $y_0 + \Delta y \in [c, d]$ nuqtalarni olib, $F(y)$ funksiyaning orttirmasini topamiz:

$$\Delta F(y_0) = F(y_0 + \Delta y) - F(y_0) = \int_a^{+\infty} [f(x, y_0 + \Delta y) - f(x, y_0)] dx.$$

Shartga ko'ra $\int_a^{+\infty} f(x, y) dx$ integral $[c, d]$ da tekis yaqinlashuvchi.

U holda

$$\forall \varepsilon > 0, \exists \delta = \delta(\varepsilon) > 0, \forall t_0 > \delta, \forall y \in [c, d]: \left| \int_{t_0}^{+\infty} f(x, y) dx \right| < \frac{\varepsilon}{3} \quad (5)$$

bo'ladi. Ravshanki, $f(x, y)$ funksiya

$$M_{t_0} = \{(x, y) \in R^2 : x \in [a, t_0], y \in [c, d]\}, \quad (a < t_0 < +\infty)$$

to'plamda tekis uzluksiz bo'ladi. U holda

$$\forall \varepsilon > 0, \exists \delta_1 = \delta_1(\varepsilon) > 0, \Delta y < \delta_1(\varepsilon) :$$

$$|f(x, y_0 + \Delta y) - f(x, y_0)| < \frac{\varepsilon}{3(t_0 - a)} \quad (6)$$

ga ega bo'lamiz. Agar $\delta_0 = \max\{\delta, \delta_1\}$ deyilsa, uning uchun (5) va (6) tengsizliklar bir yo'la bajariladi. (5) va (6) munosabatlarni e'tiborga olib topamiz:

$$\begin{aligned} |\Delta F(y_0)| &= \left| \int_a^{+\infty} [f(x, y_0 + \Delta y) - f(x, y_0)] dx \right| \leq \\ &\leq \int_a^{t_0} |f(x, y_0 + \Delta y) - f(x, y_0)| dx + \left| \int_{t_0}^{+\infty} f(x, y_0 + \Delta y) dx \right| + \left| \int_{t_0}^{+\infty} f(x, y_0) dx \right| < \varepsilon. \end{aligned}$$

Demak, $\lim_{\Delta y \rightarrow 0} \Delta F(y_0) = 0.$

Bu esa $F(y)$ funksiyaning $[c, d]$ oraliqda uzluksizligini bildiradi. ►

2- misol. Ushbu $F(y) = \int_0^{+\infty} e^{-(x-y)^2} dx$ integral y parametrning uz-

luksiz funksiyasi bo'lishi ko'rsatilsin.

◀ Berilgan integralda $x - y = t$ almashtirish bajaramiz. U holda

$$F(y) = \int_{-y}^{+\infty} e^{-t^2} dt = \int_{-y}^0 e^{-t^2} dt + \int_0^{+\infty} e^{-t^2} dt = \int_0^y e^{-t^2} dt + \int_0^{+\infty} e^{-t^2} dt$$

bo'lib, bu yig'indining har bir qo'shiluvchisi y ning uzluksiz funksiyasi bo'lgani uchun berilgan integral y parametrlning uzluksiz funksiyasi bo'ladi. ▶

3°. $F(y)$ funksiyani differensiallash. Faraz qilaylik, $f(x, y)$ funksiya M_0 to'plamda berilgan bo'lsin.

3- teorema. $f(x, y)$ funksiya quyidagi shartlarni qanoatlantirsin:

- 1) $f(x, y)$ funksiya M_0 to'plamda uzluksiz;
- 2) $f'_y(x, y)$ xususiy hosila mavjud va u M_0 to'plamda uzluksiz;
- 3) Har bir tayin $y \in [c, d]$ da

$$F(y) = \int_a^{+\infty} f(x, y) dx$$

integral yaqinlashuvchi;

- 4) Ushbu $\int_a^{+\infty} f'_y(x, y) dx$ integral $[c, d]$ da tekis yaqinlashuvchi.

U holda $F(y)$ funksiya $[c, d]$ da $F'(y)$ hosilaga ega va

$$F'(y) = \int_a^{+\infty} f'_y(x, y) dx$$

bo'ladi.

◀ $y_0 \in [c, d]$, $y_0 + \Delta y \in [c, d]$ nuqtalarni olib, topamiz:

$$\frac{F(y_0 + \Delta y) - F(y_0)}{\Delta y} = \int_a^{+\infty} \frac{f(x, y_0 + \Delta y) - f(x, y_0)}{\Delta y} dx.$$

Lagranj teoremasiga ko'ra

$$\frac{f(x, y_0 + \Delta y) - f(x, y_0)}{\Delta y} = f'_y(x, y_0 + \theta \Delta y), \quad (0 < \theta < 1),$$

$$\frac{F(y_0 + \Delta y) - F(y_0)}{\Delta y} = \int_a^{+\infty} f'_y(x, y_0 + \theta \Delta y) dx$$

bo'ladi. Demak,

$$\lim_{\Delta y \rightarrow 0} \frac{F(y_0 + \Delta y) - F(y_0)}{\Delta y} = \lim_{\Delta y \rightarrow 0} \int_a^{+\infty} f'_y(x, y_0 + \theta \Delta y) dx. \quad (7)$$

Shartga ko'ra $f'_y(x, y)$ funksiya M_0 to'plamda uzluksiz. Kantor teoremasiga binoan u

$$M_t = \{(x, y) \in R^2 : x \in [a, t], y \in [c, d]\}, \quad (a < t < \infty)$$

to'plamda tekis uzluksiz bo'ladi. U holda

$$\forall \varepsilon > 0, \exists \delta = \delta(\varepsilon) > 0, |\Delta y| < \delta(\varepsilon), \forall x \in [a, t],$$

$$|f'_y(x, y_0 + \theta \Delta y) - f'_y(x, y_0)| < \varepsilon$$

bo'ladi. Demak, $\Delta y \rightarrow 0$ da $f'_y(x, y_0 + \theta \Delta y)$ funksiya $f'_y(x, y_0)$ ga tekis yaqinlashadi. Shartga ko'ra

$$\int_a^{+\infty} f'_y(x, y_0) dx$$

integral tekis yaqinlashuvchi. U holda

$$\forall \varepsilon > 0, \exists \delta = \delta(\varepsilon) > 0, t' > \delta, t'' > \delta, \forall t', t'', \forall y \in [c, d]:$$

$$\left| \int_{t'}^{t''} f'_y(x, y) dx \right| < \varepsilon,$$

jumladan,

$$\left| \int_{t'}^{t''} f'_y(x, y_0 + \theta \Delta y) dx \right| < \varepsilon$$

bo'ladi. Keyingi tengsizlikning bajarilishidan esa

$$\int_a^{+\infty} f'_y(x, y_0 + \theta \Delta y) dx$$

integralning tekis yaqinlashuvchanligi kelib chiqadi. Ushbu ma'ruzada keltirilgan 1- teoremani (7) tenglikning o'ng tomoniga qo'llab, to-pamiz:

$$\begin{aligned} \lim_{\Delta y \rightarrow 0} \int_a^{+\infty} f'_y(x, y_0 + \theta \Delta y) dx &= \int_a^{+\infty} \left[\lim_{\Delta y \rightarrow 0} f'_y(x, y_0 + \theta \Delta y) \right] dx = \\ &= \int_a^{+\infty} f'_y(x, y_0) dx. \end{aligned} \quad (8)$$

(7) va (8) munosabatlardan

$$F'(y_0) = \int_a^{+\infty} f'_y(x, y_0) dx \quad (9)$$

bo'lishi kelib chiqadi.

(9) munosabatni quyidagicha ham yozish mumkin:

$$\frac{d}{dy} \int_a^{+\infty} f(x, y) dx = \int_a^{+\infty} \frac{\partial f(x, y)}{\partial y} dx .$$

Bu differensiallash amalini integral ostiga o'tkazish qoidasini ifodalaydi. ►

4°. $F(y)$ funksiyani integrallash. Aytaylik, $f(x, y)$ funksiya

$$M_0 = \{(x, y) \in R^2 : x \in [a, +\infty), y \in [c, d]\}$$

to'plamda berilgan bo'lsin.

4- teorema. Agar $f(x, y)$ funksiya M_0 to'plamda uzluksiz va

$F(y) = \int_a^{+\infty} f(x, y) dx$ integral $[c, d]$ da tekis yaqinlashuvchi bo'lsa, u

holda $F(y)$ funksiya $[c, d]$ da integrallanuvchi va

$$\int_c^d F(y) dy = \int_c^d \left[\int_a^{+\infty} f(x, y) dx \right] dy = \int_a^{+\infty} \left[\int_c^d f(x, y) dy \right] dx$$

bo'ladi.

◀ Ravshanki, $F(y)$ funksiya $[c, d]$ da uzluksiz bo'ladi. Binobarin, u $[c, d]$ da integrallanuvchi. Shartga ko'ra

$$F(y) = \int_a^{+\infty} f(x, y) dx$$

integral $[c, d]$ da tekis yaqinlashuvchi. U holda

$$\forall \varepsilon > 0, \exists \delta = \delta(\varepsilon) > 0, \forall t > \delta, \forall y \in [c, d]: \left| \int_t^{+\infty} f(x, y) dx \right| < \varepsilon$$

bo'ladi. Shu tengsizlik bajariladigan t ni olib topamiz:

$$\int_a^{+\infty} f(x, y) dx = \int_a^t f(x, y) dx + \int_t^{+\infty} f(x, y) dx.$$

Natijada

$$\begin{aligned} \int_c^d \left[\int_a^{+\infty} f(x, y) dx \right] dy &= \int_c^d \left[\int_a^t f(x, y) dx \right] dy + \int_c^d \left[\int_t^{+\infty} f(x, y) dx \right] dy = \\ &= \int_a^t \left[\int_c^d f(x, y) dy \right] dx + \int_c^d \left[\int_t^{+\infty} f(x, y) dx \right] dy \end{aligned}$$

bo'ladi. Agar

$$\left| \int_c^d F(y) dy - \int_c^d \left[\int_a^t f(x, y) dy \right] dx \right| \leq \int_c^d \left| \int_t^{+\infty} f(x, y) dx \right| dy < \varepsilon(d - c)$$

bo'lishini e'tiborga olsak, u holda

$$\int_c^d F(y) dy = \lim_{t \rightarrow \infty} \int_a^t \left[\int_c^d f(x, y) dy \right] dx = \int_a^{\infty} \left[\int_c^d f(x, y) dy \right] dx$$

bo'lib,

$$\int_c^d \left[\int_a^{+\infty} f(x, y) dx \right] dy = \int_a^{\infty} \left[\int_c^d f(x, y) dy \right] dx$$

ekanligi kelib chiqadi. ►

Mashqlar

1. Agar $f(x)$ funksiya $(0, \infty)$ da integrallanuvchi bo'lib,

$$F(y) = \int_0^{\infty} e^{-yx} f(x) dx$$

bo'lsa,
$$\lim_{y \rightarrow +0} F(y) = \lim_{y \rightarrow +0} \int_0^{\infty} e^{-yx} f(x) dx = \int_0^{\infty} f(x) dx$$

bo'lishi isbotlansin.

2. Ushbu $F(y) = \int_0^{\infty} e^{-y^2 x} y dx$, ($-\infty < y < +\infty$) funksiya uzluksizlikka tekshirilsin.

79- ma'ruza

Ba'zi xosmas integrallarni hisoblash

Parametrga bog'liq integrallar va ularning funksional xossalardan foydalanib, ba'zi xosmas integrallarni hisoblaymiz.

1°. $\int_0^{+\infty} \frac{\sin x}{x} dx$ integralni hisoblash. Bu integralning yaqinlashuv-

chiligi 77- ma'ruzada keltirilgan.

Ma'lumki,
$$\int_0^{+\infty} e^{-xy} \sin x dx = \frac{1}{1+y^2}. \quad (1)$$

Bu tenglikdagi

$$F(y) = \int_0^{+\infty} e^{-xy} \sin x dx$$

parametrga bog'liq integral y parametr bo'yicha ixtiyoriy $[t, A]$ da ($t > 0$) tekis yaqinlashuvchi bo'ladi. Bu tasdiq

$$|e^{-xy} \sin x| < e^{-ty}, \quad \int_0^{+\infty} e^{-ty} dx = \frac{1}{t}$$

bo'lishi hamda Veyershtrass alomatini qo'llashdan kelib chiqadi. (1) tenglikni integrallab topamiz:

$$\int_t^A \left[\int_0^{+\infty} e^{-xy} \sin x dx \right] dy = \int_t^A \frac{1}{1+y^2} dy = \arctg A - \arctg t.$$

Bu tenglikning chap tomonidagi integral uchun

$$\int_t^A \left[\int_0^{+\infty} e^{-xy} \sin x dx \right] dy = \int_0^{+\infty} \left[\int_t^A e^{-xy} \sin x dy \right] dx = \int_0^{+\infty} \frac{e^{-tx} - e^{-Ax}}{x} \sin x dx$$

va $\forall x \geq 0$ da $|\sin x| \leq x$ bo'lib,

$$\left| \int_0^{+\infty} \frac{e^{-Ax}}{x} \sin x dx \right| \leq \int_0^{+\infty} e^{-Ax} dx = \frac{1}{A}$$

bo'ladi. Natijada $A \rightarrow +\infty$ da

$$\frac{\pi}{2} - \operatorname{arctg} t = \int_0^{+\infty} e^{-tx} \frac{\sin x}{x} dx \quad (2)$$

bo'lishi kelib chiqadi. Endi

$$\lim_{t \rightarrow +0} \int_0^{+\infty} e^{-ty} \frac{\sin x}{x} dx = \int_0^{+\infty} \frac{\sin x}{x} dx$$

tenglikning o'rinli ekanini (qaralsin, 78- ma'ruza) e'tiborga olib (2) da $t \rightarrow +0$ da limitga o'tib topamiz:

$$\int_0^{+\infty} \frac{\sin x}{x} dx = \frac{\pi}{2}.$$

2°. $\int_0^{+\infty} \frac{\sin yx}{x} dx$ **integralni hisoblash.** Bu integralning $(-\infty, +\infty)$ da

yaqinlashuvchi bo'lishi ravshan. Aytaylik, $y > 0$ bo'lsin. Bu holda integralda $yx = t$ almashtirish bajarib topamiz:

$$\int_0^{+\infty} \frac{\sin yx}{x} dx = \int_0^{+\infty} \frac{\sin t}{t} dt = \frac{\pi}{2}.$$

Aytaylik, $y < 0$ bo'lsin. Bu holda qaralayotgan integralda $yx = -t$ almashtirish bajarib topamiz:

$$\int_0^{+\infty} \frac{\sin yx}{x} dx = - \int_0^{+\infty} \frac{\sin t}{t} dt = - \frac{\pi}{2}.$$

Aytaylik, $y = 0$ bo'lsin. Bu holda

$$\int_0^{+\infty} \frac{\sin 0x}{x} dx = 0$$

bo'ladi. Demak,

$$\int_0^{+\infty} \frac{\sin yx}{x} dx = \begin{cases} \frac{\pi}{2}, & \text{agar } y > 0, \\ 0, & \text{agar } y = 0, \\ -\frac{\pi}{2}, & \text{agar } y < 0, \end{cases}$$

ya'ni $\int_0^{+\infty} \frac{\sin yx}{x} dx = \frac{\pi}{2} \text{sign}y$ bo'ladi.

3°. $\int_0^{+\infty} \frac{x^{a-1}}{1+x} dx$ **integralni hisoblash.** Avvalo bu parametr ga bog'liq

liq xosmas integralni yaqinlashuvchanlikka tekshiramiz. Buning uchun berilgan integralni quyidagicha yozib olamiz:

$$F(a) = \int_0^{+\infty} \frac{x^{a-1}}{1+x} dx = \int_0^1 \frac{x^{a-1}}{1+x} dx + \int_1^{+\infty} \frac{x^{a-1}}{1+x} dx. \quad (3)$$

Aytaylik, $0 < x < 1$ bo'lsin. Bu holda

$$\frac{x^{a-1}}{1+x} < x^{a-1}$$

bo'lib, $a > 0$ da ushbu

$$\int_0^1 x^{a-1} dx$$

integralning yaqinlashuvchi bo'lganligidan, $a > 0$ da

$$\int_0^1 \frac{x^{a-1}}{1+x} dx$$

integralning ham yaqinlashuvchi bo'lishi kelib chiqadi.

Aytaylik, $x \geq 1$ bo'lsin. Bu holda

$$\frac{x^{a-1}}{1+x} < x^{a-2}$$

bo'lib, $a < 1$ da ushbu

$$\int_1^{+\infty} x^{a-2} dx$$

integralning yaqinlashuvchi bo'lganligidan, $a < 1$ da

$$\int_1^{+\infty} \frac{x^{a-1}}{1+x} dx$$

integralning ham yaqinlashuvchi bo'lishi kelib chiqadi.

Demak, qaralayotgan

$$F(a) = \int_0^{+\infty} \frac{x^{a-1}}{1+x} dx$$

integral $0 < a < 1$ da yaqinlashuvchi bo'ladi.

Endi $F(a)$ integralni hisoblaymiz. Ma'lumki, $0 < x < 1$ da

$$\frac{1}{1+x} = \sum_{k=0}^{\infty} (-1)^k x^k.$$

Bu tenglikdan

$$\frac{x^{a-1}}{1+x} = \sum_{k=0}^{\infty} (-1)^k x^{a+k-1}$$

bo'lishini topamiz. Tenglikning o'ng tomonidagi qator $[a_0, b_0]$ da ($0 < a_0 \leq x \leq b_0 < 1$) tekis yaqinlashuvchi bo'lib, uning qisman yig'indisi

$$S_n(x) = \sum_{k=0}^{n-1} (-1)^k x^{a+k-1} = \frac{x^{a-1}(1-(-x)^n)}{1+x}$$

bo'ladi. Agar $\forall n \in \mathbb{N}$, $\forall x \in (0, 1)$ uchun

$$\frac{x^{a-1}(1-(-x)^n)}{1+x} < x^{a-1}$$

tengsizlikni hamda $\int_0^1 x^{a-1} dx$, ($0 < a < 1$) integralning yaqinlashuvchi ekanligini e'tiborga olsak, u holda Veyershtrass alomatiga ko'ra

$$\int_0^1 S_n(x) dx$$

tekis yaqinlashuvchi bo'ladi. Demak,

$$\lim_{n \rightarrow \infty} \int_0^1 S_n(x) dx = \int_0^1 \left(\lim_{n \rightarrow \infty} S_n(x) \right) dx ,$$

ya'ni

$$\lim_{n \rightarrow \infty} \int_0^1 \left(\sum_{k=0}^{n-1} (-1)^k x^{a+k-1} \right) dx = \int_0^1 \left(\lim_{n \rightarrow \infty} \sum_{k=0}^{n-1} (-1)^k x^{a+k-1} \right) dx = \int_0^1 \frac{x^{a-1}}{1+x} dx$$

bo'ladi. Demak,

$$\begin{aligned} \int_0^1 \frac{x^{a-1}}{1+x} dx &= \lim_{n \rightarrow \infty} \int_0^1 \left(\sum_{k=0}^{n-1} (-1)^k x^{a+k-1} \right) dx = \\ &= \sum_{k=0}^{n-1} \int_0^1 \left((-1)^k x^{a+k-1} \right) dx = \sum_{k=0}^{n-1} \frac{(-1)^k}{a+k}. \end{aligned} \quad (4)$$

Endi $\int_1^{+\infty} \frac{x^{a-1}}{1+x} dx$ integralda $x = \frac{1}{t}$ almashtirish bajarsak, u holda

$$\int_1^{+\infty} \frac{x^{a-1}}{1+x} dx = \int_0^1 \frac{t^{-a}}{1+t} dt = \int_0^1 \frac{t^{(1-a)-1}}{1+t} dt$$

bo'lib, yuqoridagi (4) munosabatga ko'ra

$$\int_1^{+\infty} \frac{x^{a-1}}{1+x} dx = \sum_{k=1}^{\infty} \frac{(-1)^k}{a-k} \quad (5)$$

bo'ladi. (3), (4) va (5) munosabatlardan

$$\int_1^{+\infty} \frac{x^{a-1}}{1+x} dx = \frac{1}{a} + \sum_{k=1}^{\infty} (-1)^k \left[\frac{1}{a+k} + \frac{1}{a-k} \right]$$

bo'lishi kelib chiqadi. Ma'lumki,

$$\frac{1}{a} + \sum_{k=1}^{\infty} (-1)^k \left[\frac{1}{a+k} + \frac{1}{a-k} \right] = \frac{\pi}{\sin a\pi}, \quad (0 < a < 1)$$

(qaralsin, 76-ma'ruza). Demak, quyidagi ifoda kelib chiqadi:

$$\int_0^{+\infty} \frac{x^{a-1}}{1+x} dx = \frac{\pi}{\sin a\pi}, \quad (0 < a < 1).$$

4°. $\int_0^{+\infty} \frac{f(ax)-f(bx)}{x} dx$ **integralni hisoblash.** Bunda $f(x)$ funksiya

$[0, +\infty]$ da uzluksiz, istalgan $A > 0$ da $\int_A^{+\infty} \frac{f(x)}{x} dx$ integral yaqinlashuvchi va $a > 0, b > 0$.

Berilgan integralni quyidagi ikkita integralning limiti deb qaraymiz:

$$\int_0^{+\infty} \frac{f(ax)-f(bx)}{x} dx = \lim_{\delta \rightarrow 0} \left[\int_{\delta}^{+\infty} \frac{f(ax)}{x} dx - \int_{\delta}^{+\infty} \frac{f(bx)}{x} dx \right].$$

Bu tenglikning o'ng tomonidagi birinchi integralda $ax = t$, ikkinchi integralda $bx = t$ almashtirishlarni bajarib topamiz:

$$\int_0^{+\infty} \frac{f(ax)-f(bx)}{x} dx = \lim_{\delta \rightarrow 0} \int_{a\delta}^{+\infty} \frac{f(t)}{t} dt - \lim_{\delta \rightarrow 0} \int_{b\delta}^{+\infty} \frac{f(t)}{t} dt = \lim_{\delta \rightarrow 0} \int_{a\delta}^{b\delta} \frac{f(t)}{t} dt.$$

Ravshanki, $f(t)$ – uzluksiz funksiya, $\frac{1}{t}$ funksiya esa ishora saqlaydi (chunki $a > 0, b > 0, x \in (0, +\infty)$). Demak,

$$\int_{a\delta}^{b\delta} \frac{f(t)}{t} dt$$

integralda o'rta qiymat haqidagi teoremani qo'llash mumkin:

$$\int_{a\delta}^{b\delta} \frac{f(t)}{t} dt = f(\xi) \int_{a\delta}^{b\delta} \frac{dt}{t}.$$

Natijada $\lim_{\delta \rightarrow 0} \int_{a\delta}^{b\delta} \frac{f(t)}{t} dt = \lim_{\delta \rightarrow 0} f(\xi) \int_{a\delta}^{b\delta} \frac{1}{t} dt = \lim_{\delta \rightarrow 0} f(\xi) \ln \frac{b}{a}$ (7)

bo'ladi. Modomiki, ξ nuqta $a\delta$ bilan $b\delta$ orasida ekan, $\delta \rightarrow 0$ da $\xi \rightarrow 0$ va

$$\lim_{\xi \rightarrow 0} f(\xi) = f(0)$$
 (8)

bo'ladi. (6), (7) va (8) munosabatlardan

$$\int_0^{+\infty} \frac{f(ax) - f(bx)}{x} dx = f(0) \ln \frac{b}{a}$$

bo'lishi kelib chiqadi.

5°. Ba'zi xosmas integrallarning qiymatlari. Quyida ba'zi xosmas integrallarning qiymatlarini keltiramiz:

$$1. \int_0^{+\infty} e^{-x^2} dx = \frac{\sqrt{\pi}}{2}.$$

$$2. \int_0^{+\infty} \sin x^2 dx = \frac{\sqrt{2}}{2}.$$

$$3. \int_0^{+\infty} \cos x^2 dx = \frac{\sqrt{2}}{2}.$$

$$4. \int_0^{+\infty} \frac{\cos xy}{1+x^2} dx = \frac{\pi}{2} e^{-|y|}.$$

$$5. \int_0^{+\infty} \frac{x \sin xy}{1+x^2} dx = \frac{\pi}{2} \operatorname{sign} y e^{-|y|}.$$

$$6. \int_0^{+\infty} \frac{\sin x^2}{x} dx = \frac{\pi}{4}.$$

$$7. \int_0^{+\infty} \frac{\sin^4 ax - \sin^4 bx}{x} dx = \frac{3}{8} \ln \frac{a}{b}.$$

$$8. \int_0^{+\infty} \frac{e^{-ax} - e^{-bx}}{x} \sin nx dx = \operatorname{arctg} \frac{b}{n} - \operatorname{arctg} \frac{a}{n}, \quad (a > 0, b > 0, n \neq 0).$$

$$9. \int_0^{+\infty} \frac{e^{-ax} - e^{-bx}}{x} \cos nx dx = \frac{1}{2} \ln \frac{b^2 + n^2}{a^2 + n^2}.$$

Mashqlar

1. Ushbu $\int_0^{+\infty} \frac{1 - \cos xy}{x} e^{-kx} dx = \frac{1}{2} \ln \left(1 + \frac{y^2}{k^2} \right)$, ($y > 0, k > 0$) tenglik

isbotlansin.

2. Ushbu $\int_0^{+\infty} \frac{\ln(1+a^2x^2)}{b^2+x^2} dx$, ($a > 0, b > 0$) integral hisoblansin.

3. Ushbu $\int_0^{+\infty} \frac{dx}{x^2+a} = \frac{\pi}{2\sqrt{a}}$, ($a > 0$) tenglikdan foydalanib,

$$\int_0^{+\infty} \frac{dx}{(x^2+a)^{n+1}}, \quad (n \in \mathbb{N})$$

integral hisoblansin.

80- ma'ruza

Eyler integrallari

Biz 48- ma'ruzada ushbu

$$\int_0^1 x^{a-1} (1-x)^{b-1} dx$$

xosmas integralning $a > 0, b > 0$ bo'lganda yaqinlashuvchi ekanligini,

$$\int_0^{+\infty} x^{a-1} e^{-x} dx$$

xosmas integralning esa $a > 0$ bo'lganda yaqinlashuvchiligini isbotlagan edik.

Ravshanki, bu xosmas integrallar a va b larga bog'liq, ya'ni parametrga bog'liq xosmas integrallar bo'ladi.

1°. Beta funksiya va uning tekis yaqinlashuvchanligi. Ushbu

$$\int_0^1 x^{a-1} (1-x)^{b-1} dx$$

parametrga bog'liq xosmas integral *beta funksiya (1- tur Eylar integrali)* deyiladi va $B(a, b)$ kabi belgilanadi:

$$B(a, b) = \int_0^1 x^{a-1} (1-x)^{b-1} dx, \quad (a > 0, b > 0).$$

Demak, beta funksiya

$$\{(a, b) \in R^2 : a \in (0, +\infty), b \in (0, +\infty)\}$$

to'plamda aniqlangan funksiya.

1- teorema. Ushbu

$$B(a, b) = \int_0^1 x^{a-1} (1-x)^{b-1} dx$$

integral $M_0 = \{(a, b) \in R^2 : a \in [a_0, +\infty), b \in [b_0, +\infty), a_0 > 0, b_0 > 0\}$ to'plamda tekis yaqinlashuvchi bo'ladi.

◀ $B(a, b)$ funksiyani ifodalovchi integralni ikki qismga

$$\int_0^1 x^{a-1} (1-x)^{b-1} dx = \int_0^{\frac{1}{2}} x^{a-1} (1-x)^{b-1} dx + \int_{\frac{1}{2}}^1 x^{a-1} (1-x)^{b-1} dx$$

ko'rinishda ajratib, har bir integralni tekis yaqinlashishga tekshiramiz.

Parametr $a \geq a_0, (a_0 > 0), \forall b > 0, \forall x \in \left(0, \frac{1}{2}\right]$ da

$$x^{a-1} (1-x)^{b-1} \leq x^{a_0-1} (1-x)^{b-1} \leq 2x^{a_0-1}$$

va $a > 0$ bo'lganda

$$\int_0^{\frac{1}{2}} x^{a-1} dx$$

integralning yaqinlashuvchi bo'lishidan Veyershtrass alomatiga ko'ra

$$\int_0^{\frac{1}{2}} x^{a-1} (1-x)^{b-1} dx$$

integralning $a \geq a_0$, ($a_0 > 0$) da tekis yaqinlashuvchanligini topamiz. Shuningdek, parametr $b \geq b_0$, ($b_0 > 0$), $\forall a > 0$, $\forall x \in \left(\frac{1}{2}, 1\right]$ da

$$x^{a-1}(1-x)^{b-1} \leq x^{a-1}(1-x)^{b_0-1} \leq 2(1-x)^{b_0-1}$$

va $b > 0$ bo'lganda
$$\int_{\frac{1}{2}}^1 (1-x)^{b-1} dx$$

integralning yaqinlashuvchi bo'lishidan Veyershtross alomatiga ko'ra

$$\int_{\frac{1}{2}}^1 x^{a-1}(1-x)^{b-1} dx$$

integralning $b \geq b_0$, ($b_0 > 0$) da tekis yaqinlashuvchi bo'lishini topamiz. Demak,

$$B(a, b) = \int_0^1 x^{a-1}(1-x)^{b-1} dx$$

integral $M_0 = \{(a, b) \in \mathbb{R}^2 : a \in [a_0, +\infty), b \in [b_0, +\infty), a_0 > 0, b_0 > 0\}$ to'plamda tekis yaqinlashuvchi bo'ladi. ►

Natija. $B(a, b)$ funksiya

$$M = \{(a, b) \in \mathbb{R}^2 : a \in (0, +\infty), b \in (0, +\infty)\}$$

to'plamda uzluksiz bo'ladi.

◀ Bu tasdiq
$$\int_0^1 x^{a-1}(1-x)^{b-1} dx$$

integralning tekis yaqinlashuvchanligi hamda integral ostidagi funksiyaning M to'plamda uzluksiz bo'lishidan kelib chiqadi. ►

2°. $B(a, b)$ funksiyaning xossalari. Endi

$$B(a, b) = \int_0^1 x^{a-1}(1-x)^{b-1} dx$$

funksiyaning xossalarini keltiramiz.

1) $B(a, b)$ funksiya a va b argumentlariga nisbatan simmetrik funksiya, ya'ni:

$$B(a, b) = B(b, a), \quad (a > 0, b > 0).$$

◀ $B(a, b)$ ni ifodalovchi integralda $x = 1 - t$ almashtirish bajarib topamiz:

$$\begin{aligned} B(a, b) &= \int_0^1 x^{a-1} (1-x)^{b-1} dx = -\int_1^0 (1-t)^{a-1} t^{b-1} dt = \\ &= \int_0^1 t^{b-1} (1-t)^{a-1} dt = B(b, a). \quad \blacktriangleright \end{aligned}$$

2) $B(a, b)$ funksiyaning quyidagicha ifodalash ham mumkin:

$$B(a, b) = \int_0^{+\infty} \frac{t^{a-1}}{(1+t)^{a+b}} dt. \quad (1)$$

◀ $B(a, b)$ ni ifodalovchi integralda $x = \frac{t}{1+t}$ almashtirish bajarib topamiz:

$$B(a, b) = \int_0^1 x^{a-1} (1-x)^{b-1} dx = \int_0^{+\infty} \left(\frac{t}{1+t}\right)^{a-1} \left(1 - \frac{t}{1+t}\right)^{b-1} \frac{dt}{(1+t)^2} = \int_0^{+\infty} \frac{t^{a-1}}{(1+t)^{a+b}} dt. \quad \blacktriangleright$$

Agar (1) da $b = 1 - a$, ($0 < a < 1$) deyilsa, u holda

$$B(a, 1-a) = \int_0^{+\infty} \frac{t^{a-1}}{1+t} dt = \frac{\pi}{\sin \pi a}$$

bo'ladi. Xususan: $B\left(\frac{1}{2}, \frac{1}{2}\right) = \pi$.

3) $B(a, b)$ funksiya uchun ushbu

$$B(a+1, b) = \frac{a}{a+b} B(a, b), \quad (a > 0, b > 0)$$

formula o'rinli bo'ladi.

◀ Ravshanki, $B(a+1, b) = \int_0^1 x^a (1-x)^{b-1} dx$.

Bu integralni bo‘laklab integrallaymiz:

$$\begin{aligned}
 B(a+1, b) &= \int_0^1 x^a (1-x)^{b-1} dx = -\frac{1}{b} \int_0^1 x^a d((1-x)^b) = \\
 &= -\frac{1}{b} x^a (1-x)^b \Big|_0^1 + \frac{a}{b} \int_0^1 x^{a-1} (1-x)^b dx = \\
 &= \frac{a}{b} \int_0^1 x^{a-1} (1-x)^b dx = \frac{a}{b} \left[\int_0^1 x^{a-1} (1-x)^{b-1} dx - \int_0^1 x^a (1-x)^{b-1} dx \right] = \\
 &= \frac{a}{b} B(a, b) - \frac{a}{b} B(a+1, b).
 \end{aligned}$$

Natijada

$$B(a+1, b) = \frac{a}{b} B(a, b) - \frac{a}{b} B(a+1, b) \quad (2)$$

bo‘lib, undan

$$B(a+1, b) = \frac{a}{a+b} B(a, b)$$

bo‘lishi kelib chiqadi. ►

$B(a, b)$ funksiya simmetrik bo‘lganligidan

$$B(a, b+1) = \frac{b}{a+b} B(a, b) \quad (3)$$

ifodani yozish mumkin.

Natija. $B(m, n)$ funksiyaga ($m \in N, n \in N$) (2) va (3) formulalarni takror qo‘llash natijasida

$$B(m, n) = \frac{(m-1)!(n-1)!}{(m+n-1)!}$$

bo‘lishi kelib chiqadi.

3^o. Gamma funksiya va uning yaqinlashuvchanligi. Ushbu

$$\int_0^{+\infty} x^{a-1} e^{-x} dx$$

parametrga bog‘liq xosmas integral *gamma funksiya* (2- tur Eylerni integrali) deyiladi va $\Gamma(a)$ kabi belgilanadi:

$$\Gamma(a) = \int_0^{+\infty} x^{a-1} e^{-x} dx.$$

Demak, gamma funksiya $(0, +\infty)$ da aniqlangan funksiya.

2- teorema. Ushbu $\Gamma(a) = \int_0^{+\infty} x^{a-1} e^{-x} dx$

integral $[a_0, b_0]$ da $(0 < a_0 < b_0 < +\infty)$ tekis yaqinlashuvchi bo'ladi.

◀ $\Gamma(a)$ funksiyani ifodalovchi integralni ikki integral yig'indisi sifatida yozib olamiz:

$$\Gamma(a) = \int_0^1 x^{a-1} e^{-x} dx + \int_1^{+\infty} x^{a-1} e^{-x} dx.$$

So'ngra ikkala integralning ixtiyoriy $[a_0, b_0]$ segmentda $(0 < a_0 < b_0 < +\infty)$ tekis yaqinlashuvchi bo'lishini ko'rsatamiz. Parametr $a \geq a_0$ ($a_0 > 0$), $\forall x \in (0, 1]$ da

$$x^{a-1} e^{-x} \leq x^{a_0-1}$$

va $a_0 > 0$ da $\int_0^1 x^{a_0-1} dx$

integralning yaqinlashuvchi bo'lishidan Veyershtress alomatiga ko'ra

$$\int_0^1 x^{a-1} e^{-x} dx$$

integralning $a \geq a_0$ da tekis yaqinlashuvchi bo'lishi kelib chiqadi. Shuningdek, parametr $a \leq b_0$, $\forall x \in [1, +\infty)$ da

$$x^{a-1} e^{-x} \leq x^{b_0-1} e^{-x} \quad \text{va} \quad \int_1^{+\infty} x^{b_0-1} e^{-x} dx$$

integralning yaqinlashuvchi bo'lishidan yana Veyershtress alomatiga ko'ra

$$\int_1^{+\infty} x^{a-1} e^{-x} dx$$

integralning $a \leq b_0$ da tekis yaqinlashuvchi bo'lishini topamiz. Demak,

$$\Gamma(a) = \int_0^{+\infty} x^{a-1} e^{-x} dx$$

xosmas integral $[a_0, b_0]$ da tekis yaqinlashuvchi bo'ladi. ►

Natija. $\Gamma(a)$ funksiya $(0, +\infty)$ da uzluksiz bo'ladi.

◀ Bu tasdiq

$$\int_0^{+\infty} x^{a-1} e^{-x} dx$$

integralning tekis yaqinlashuvchiligi hamda integral ostidagi funksiyaning $M = \{(x, a) \in R^2 : x \in (0, +\infty), a \in (0, +\infty)\}$ da uzluksiz bo'lishidan kelib chiqadi. ►

4°. $\Gamma(a)$ funksiyaning xossalari. 1) Gamma funksiya $(0, +\infty)$ da barcha tartibdagi uzluksiz hosilalarga ega va

$$\Gamma^{(n)}(a) = \int_0^{+\infty} x^{a-1} e^{-x} (\ln x)^n dx, \quad (n = 1, 2, 3, \dots)$$

bo'ladi.

◀ Ravshanki,
$$\Gamma(a) = \int_0^{+\infty} x^{a-1} e^{-x} dx$$

integral ostidagi $f(x, a) = x^{a-1} e^{-x}$ funksiya

$$M = \{(x, a) \in R^2 : x \in (0, +\infty), a \in (0, +\infty)\}$$

to'plamda uzluksiz bo'lib, uzluksiz

$$f'_a(x, a) = x^{a-1} e^{-x} \ln x$$

hosilaga ega bo'ladi. Yuqorida aytganimizdek,

$$\Gamma(a) = \int_0^1 x^{a-1} e^{-x} dx + \int_1^{+\infty} x^{a-1} e^{-x} dx$$

tenglikning o'ng tomonidagi integrallar ixtiyoriy $[a_0, b_0]$ da $(0 < a_0 < b_0 < +\infty)$ tekis yaqinlashuvchi.

Ushbu $\int_0^1 x^{a-1} \ln x \cdot e^{-x} dx$, $\int_1^{+\infty} x^{a-1} \ln x \cdot e^{-x} dx$ integrallarni qaray-

lik. Bu integrallardan birinchisi, $a \geq a_0 > 0$ da

$$|x^{a-1} \ln x \cdot e^{-x}| \leq x^{a_0-1} |\ln x| \quad \text{va} \quad \int_0^1 x^{a_0-1} |\ln x| dx$$

integral yaqinlashuvchi bo'lganligidan Veyershtrass alomatiga ko'ra tekis yaqinlashuvchi bo'ladi. Shuningdek, ikkinchi integral ham $a \leq b_0 < +\infty$ da

$$|x^{a-1} \ln x \cdot e^{-x}| \leq x^{b_0-1} \ln x \cdot e^{-x} = x^{b_0} \cdot e^{-x} \quad \text{va} \quad \int_1^{+\infty} x^{b_0-1} \ln x \cdot e^{-x} dx$$

integral yaqinlashuvchi bo'lganligidan yana Veyershtrass alomatiga ko'ra tekis yaqinlashuvchi bo'ladi. Parametrga bog'liq xosmas integralning parametr bo'yicha differensiallash haqidagi teoremadan foydalanib topamiz:

$$\begin{aligned} \frac{d}{da} \Gamma(a) &= \frac{d}{da} \left[\int_0^1 x^{a-1} e^{-x} dx + \int_1^{+\infty} x^{a-1} e^{-x} dx \right] = \int_0^1 \frac{d}{da} (x^{a-1} e^{-x}) dx + \\ &+ \int_1^{+\infty} \frac{d}{da} (x^{a-1} e^{-x}) dx = \int_1^{+\infty} x^{a-1} \cdot \ln x \cdot e^{-x} dx. \end{aligned}$$

Demak,
$$\Gamma'(a) = \int_0^{+\infty} x^{a-1} \cdot \ln x \cdot e^{-x} dx.$$

$\Gamma'(a)$ funksiyaning $[a_0, b_0]$ da uzluksiz bo'lishi ravshan.

Xuddi shu yo'l bilan funksiyaning ikkinchi, uchinchi va hokazo tartibdagi hosilalarining mavjudligi, uzluksizligi hamda

$$\Gamma^{(n)}(a) = \int_0^{+\infty} x^{a-1} e^{-x} (\ln x)^n dx$$

bo'lishi ko'rsatiladi. ►

2) $\Gamma(a)$ funksiya uchun ushbu

$$\Gamma(a+1) = a\Gamma(a) \quad (4)$$

formula o'rinli bo'ladi.

◀ Ravshanki,
$$\Gamma(a) = \int_0^{+\infty} x^{a-1} e^{-x} dx.$$

Bu integralni bo'laklab integrallaymiz. Natijada

$$\Gamma(a+1) = \int_0^{+\infty} x^a e^{-x} dx = - \int_0^{+\infty} x^a d(e^{-x}) = -x^a e^{-x} \Big|_0^{+\infty} + a \int_0^{+\infty} x^{a-1} e^{-x} dx = a\Gamma(a)$$

bo'ladi. ▶

Ma'lumki, $a \in (0, 1]$ bo'lsa, $a+1 \in (1, 2]$ bo'ladi. $\Gamma(a)$ funksiyaning bu xossasini ifodalovchi (4) munosabat $\Gamma(a)$ funksiyaning $(0, 1]$ dagi qiymatlariga ko'ra uning $(1, 2]$ oraliqdagi qiymatlarini, umuman, ixtiyoriy $(n, n+1]$ dagi qiymatlarini topish imkonini beradi.

Natija. $\Gamma(n)$ funksiyaga ($n \in \mathbb{N}$) (4) formulani takror qo'llash natijasida ($\Gamma(1)=1$)

$$\Gamma(n) = (n-1)!$$

bo'lishi kelib chiqadi.

3) $\Gamma(a)$ funksiyaning o'zgarish xarakteri. Ravshanki,

$$\Gamma(1) = \int_0^{+\infty} e^{-x} dx = 1.$$

Yuqoridagi (4) formulaga ko'ra

$$\Gamma(2) = 1 \cdot \Gamma(1) = 1$$

bo'ladi. Roll teoremasiga muvofiq, shunday a_0 ($1 < a_0 < 2$) nuqta topiladiki,

$$\Gamma'(a_0) = 0$$

bo'ladi. Ayni paytda, $\forall a \in (0, +\infty)$ da

$$\Gamma''(a) = \int_0^{+\infty} x^{a-1} e^{-x} \ln^2 x dx > 0$$

bo'lganligi uchun $\Gamma'(a)$ funksiya $(0, +\infty)$ da qat'iy o'suvchi bo'ladi.

Binobarin, $\Gamma'(a)$ funksiya a_0 nuqtadan boshqa nuqtalarda nolga aylanmaydi. Demak,

$$\Gamma'(a) = \int_0^{+\infty} x^{a-1} e^{-x} \ln x dx = 0$$

tenglama $(0, +\infty)$ oraliqda yagona yechimga ega. U holda

$$0 < a < a_0 \text{ da } \Gamma'(a) < 0,$$

$$a_0 < a < +\infty \text{ da } \Gamma'(a) > 0$$

bo'lib, $\Gamma(a)$ funksiya a_0 nuqtada minimumga ega bo'ladi. ($a_0 = 1,4616\dots$, $\Gamma(a_0) = \min \Gamma(a) = 0,8856\dots$ bo'lishi topilgan).

$\Gamma(a)$ funksiya $a > a_0$ da o'suvchi bo'lganligi sababli $a > n+1$ bo'lganda $\Gamma(a) > \Gamma(n+1) = n!$ bo'lib, undan

$$\lim_{a \rightarrow +\infty} \Gamma(a) = +\infty$$

bo'lishi kelib chiqadi. Agar $a \rightarrow +0$ da $\Gamma(a+1) \rightarrow \Gamma(1) = 1$ hamda

$$\Gamma(a) = \frac{\Gamma(a+1)}{a}$$

bo'lishini e'tiborga olsak, u holda

$$\lim_{a \rightarrow +0} \Gamma(a) = +\infty$$

ekanligini topamiz.

5°. Beta va gamma funksiyalar orasidagi bog'lanish. Beta va gamma funksiyalar orasidagi bog'lanishni quyidagi teorema ifodalaydi.

3- teorema. $\forall (a, b) \in \{(a, b) \in \mathbb{R}^2 : a \in (0, +\infty), b \in (0, +\infty)\}$ uchun

$$B(a, b) = \frac{\Gamma(a) \cdot \Gamma(b)}{\Gamma(a+b)} \quad (5)$$

formula o'rinli bo'ladi.

$$\leftarrow \text{Ushbu} \quad \Gamma(s) = \int_0^{+\infty} x^{s-1} e^{-x} dx$$

integralda $x = (1+u)t$, ($t > 0$) almashtirish bajarib, s ni $a+b$ ga almashtiramiz. Natijada

$$\Gamma(a+b) = \int_0^{+\infty} (1+u)^{a+b-1} t^{a+b-1} e^{-(1+u)t} (1+u) dt$$

bo'lib,

$$\frac{\Gamma(a+b)}{(1+u)^{a+b}} = \int_0^{+\infty} t^{a+b-1} e^{-(1+u)t} dt$$

bo'ladi.

Endi bu tenglikning har ikki tomonini u^{a-1} ga ko'paytirib, so'ngra $(0, +\infty)$ oraliq bo'yicha integrallab topamiz:

$$\Gamma(a+b) \int_0^{+\infty} \frac{u^{a-1}}{(1+u)^{a+b}} du = \int_0^{+\infty} \left[\int_0^{+\infty} t^{a+b-1} e^{-(1+u)t} dt \right] u^{a-1} du,$$

ya'ni
$$\Gamma(a+b) \cdot B(a, b) = \int_0^{+\infty} \left[\int_0^{+\infty} t^{a+b-1} e^{-(1+u)t} dt \right] u^{a-1} du.$$

[1], 17- bob, 8- §da keltirilgan teoremdan foydalanib, keyingi tenglikning o'ng tomonidagi integrallarning o'rinlarini almashtiramiz.
Natijada

$$\Gamma(a+b) \cdot B(a, b) = \int_0^{+\infty} \left[\int_0^{+\infty} u^{a-1} e^{-(1+u)t} du \right] t^{a+b-1} dt$$

bo'ladi. Integralda $ut = y$ almashtirish bajarib topamiz:

$$\begin{aligned} \Gamma(a+b) \cdot B(a, b) &= \int_0^{+\infty} \left[\int_0^{+\infty} y^{a-1} t^{b-1} e^{-t} e^{-y} dy \right] dt = \\ &= \int_0^{+\infty} t^{b-1} e^{-t} dt \cdot \int_0^{+\infty} y^{a-1} e^{-y} dy = \Gamma(b) \cdot \Gamma(a). \end{aligned}$$

Demak,
$$B(a, b) = \frac{\Gamma(a) \cdot \Gamma(b)}{\Gamma(a+b)}. \blacktriangleright$$

Natija. $\forall a \in (0, 1)$ uchun

$$\Gamma(a)\Gamma(1-a) = \frac{\pi}{\sin \pi a} \quad (6)$$

bo'ladi.

◀ (5) tenglikda $b = 1 - a$ ($0 < a < 1$) deb olinsa, unda

$$B(a, 1 - a) = \frac{\Gamma(a) \cdot \Gamma(1 - a)}{\Gamma(1)}$$

bo'ladi. Ma'lumki,

$$B(a, 1 - a) = \frac{\pi}{\sin a\pi}, \quad \Gamma(1) = 1.$$

Demak, $\Gamma(a)\Gamma(1 - a) = \frac{\pi}{\sin a\pi}$, ($0 < a < 1$). ▶

Agar (6) formulada $a = \frac{1}{2}$ deyilsa,

$$\Gamma\left(\frac{1}{2}\right) = \sqrt{\pi}$$

bo'lishi kelib chiqadi.

1- misol. Ushbu $\int_0^{+\infty} e^{-x^2} dx$ integral hisoblansin.

◀ Bu integralda $x^2 = t$ almashtirish bajaramiz. U holda

$$dx = \frac{1}{2\sqrt{t}} dt = \frac{1}{2} t^{-\frac{1}{2}} dt$$

bo'lib,

$$\int_0^{+\infty} e^{-x^2} dx = \frac{1}{2} \int_0^{+\infty} t^{-\frac{1}{2}} e^{-t} dt = \frac{1}{2} \int_0^{+\infty} t^{\frac{1}{2}-1} e^{-t} dt = \frac{1}{2} \Gamma\left(\frac{1}{2}\right) = \frac{\sqrt{\pi}}{2}$$

bo'ladi. ▶

2- misol. Ushbu $\int_0^{+\infty} \frac{dx}{1+x^3}$ integral hisoblansin.

◀ Bu integralda $1 + x^3 = \frac{1}{y}$ almashtirish bajaramiz. U holda

$$x = \left(\frac{1-y}{y}\right)^{\frac{1}{3}}, \quad dx = \frac{1}{3} \left(\frac{1-y}{y}\right)^{-\frac{2}{3}} \cdot \left(-\frac{dy}{y^2}\right),$$

$$\int_0^{+\infty} \frac{dx}{1+x^3} = -\frac{1}{3} \int_1^0 y^{\frac{1}{3}} \left(\frac{1-y}{y}\right)^{-\frac{2}{3}} \cdot \frac{dy}{y^2} = \frac{1}{3} \int_0^1 y^{-\frac{1}{3}} (1-y)^{-\frac{2}{3}} dy =$$

$$= \frac{1}{3} B\left(\frac{2}{3}, \frac{1}{3}\right) = \frac{1}{3} \cdot \frac{\Gamma\left(\frac{1}{3}\right)\Gamma\left(\frac{2}{3}\right)}{\Gamma(1)} = \frac{1}{3} \cdot \frac{\pi}{\sin\frac{1}{3}\pi} = \frac{\pi}{3 \cdot \frac{\sqrt{3}}{2}} = \frac{2\pi}{3\sqrt{3}}$$

bo'lad. ►

Mashqlar

1. $\forall a \in \mathbb{R} \setminus \{0, -1, \dots, -n, \dots\}$ da $\Gamma(a) = \lim_{n \rightarrow \infty} \frac{n^a \cdot n!}{a(a+1)\dots(a+n)}$ bo'lishi isbotlansin.

2. Ushbu $\int_0^{+\infty} \frac{x^m dx}{(a+bx^n)^p}$, ($a > 0$, $b > 0$, $n > 0$) integral beta funksiya orqali ifodalansin.

3. Quyidagi $(\Gamma'(a))^2 < \Gamma(a) \cdot \Gamma''(a)$ tengsizlik isbotlansin.

16- B O B

KARRALI INTEGRALLAR

81- ma'ruza

Tekis shaklning yuzi hamda fazodagi jismning hajmi haqida ba'zi ma'lumotlar

Aniq integralning tatbiqlari mavzusida tekis shaklning yuzi hamda jismning hajmi haqida ma'lumotlar keltirilgan edi. Bu tushunchalar karrali integrallar nazariyasida muhimligini inobatga olib, ular to'g'ri-sidagi ta'rif va tasdiqlarni talab darajasida bayon etishni lozim topdik.

1°. **Tekis shaklning yuzi va uning mavjudligi.** Tekislikda Dekart koordinatalari sistemasini berilgan bo'lsin. Bu tekislikda sodda yopiq chiziq bilan chegaralangan tekislik qismidan tashkil topgan Q shaklni (tekislik nuqtalari to'plamini) qaraylik. Q shaklning chegarasini (sodda yopiq chiziqni) ∂Q bilan, $Q \cup \partial Q$ ni esa \bar{Q} bilan belgilaymiz:

$$\bar{Q} = Q \cup \partial Q.$$

Masalan, koordinatalari ushbu

$$x > 0, y > 0, x + y < 1$$

tengsizliklarni qanoatlantiruvchi (x, y) nuqtalardan tashkil topgan

$$\Delta = \{(x, y) : x > 0, y > 0, x + y < 1\}$$

to'plam 33- chizmada tasvirlangan uchburchak shaklini ifodalaydi.

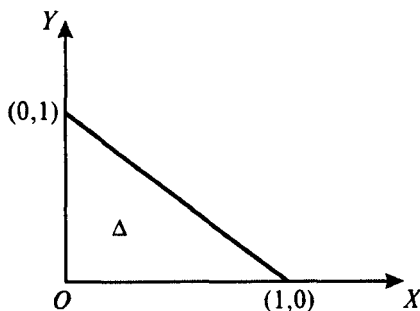

33- chizma.

OX o'qdagi birlik kesma ($0 \leq x \leq 1$) OY o'qdagi birlik kesma ($0 \leq y \leq 1$) hamda $(1,0)$ va $(0,1)$ nuqtalarni birlashtiruvchi to'g'ri chiziq kesmalari birgalikda uchburchak shaklining chegarasi $\partial \Delta$ ni tashkil etadi.

Tekislikda uchburchaklar, yopiq sinq chiziq bilan chegaralangan tekislik qismidan tashkil topgan ko'pburchaklar yuzaga ega va ularni topish o'quvchiga maktab matematika kursidan ma'lum.

Tekislikda Q shakl bilan birga A va B ko'pburchaklarni olaylik. Agar A ko'pburchakning har bir nuqtasi \bar{Q} ga tegishli bo'lsa, A ko'pburchak Q shaklning ichiga chizilgan deyiladi (bunda $A \subset \bar{Q}$ bo'ladi). Agar \bar{Q} ning har bir nuqtasi B ko'pburchakka tegishli bo'lsa, B ko'pburchak Q shaklni o'z ichiga oladi deyiladi (bunda $\bar{Q} \subset B$ bo'ladi).

Agar μA va μB lar mos ravishda A va B ko'pburchaklarning yuzalari bo'lsa, u holda

$$\mu A \leq \mu B \quad (1)$$

tengsizlik bajariladi.

Aytaylik, Q shaklning ichiga chizilgan ko'pburchaklardan iborat to'plam $\{A\}$, Q shaklni o'z ichiga olgan ko'pburchaklardan iborat to'plam $\{B\}$ bo'lib, ularning yuzalaridan iborat to'plam esa mos ravishda $\{\mu A\}$ va $\{\mu B\}$ bo'lsin.

Ravshanki, $\{\mu A\}$ va $\{\mu B\}$ lar sonlar to'plami bo'lib, $\{\mu A\}$ yuqoridan, $\{\mu B\}$ esa quyidan chegaralangan to'plamlar bo'ladi. U holda to'plamning aniq chegaralari haqidagi teoremaga ko'ra

$$\sup \{\mu A\} = \mu_* Q, \quad \inf \{\mu B\} = \mu^* Q$$

lar mavjud. Odatda, $\mu_* Q$ son shaklning quyi yuzasi, $\mu^* Q$ son esa Q shaklning yuqori yuzasi deyiladi.

Tasdiq. $\mu_* Q$ va $\mu^* Q$ miqdorlar uchun

$$\mu_* Q \leq \mu^* Q \quad (2)$$

tengsizlik bajariladi.

Aytaylik, $\mu_* Q > \mu^* Q$ bo'lsin. Bu holda, ravshanki, $\mu_* Q - \mu^* Q$ ayirma musbat bo'ladi. Aniq chegara ta'riflariga ko'ra $\forall \varepsilon > 0$, jumladan,

$$\varepsilon = \frac{1}{2} (\mu_* Q - \mu^* Q) > 0$$

uchun shunday $A_0 \subset \bar{Q}$, $\bar{Q} \subset B_0$ ko'pburchaklar topiladiki,

$$\mu A_0 > \mu_* Q - \varepsilon, \quad \mu B_0 < \mu^* Q + \varepsilon$$

tengsizliklar bajariladi. Bu tengsizliklardan foydalanib topamiz:

$$\begin{aligned} \mu B_0 - \mu A_0 &< \mu^* Q + \varepsilon - (\mu_* Q - \varepsilon) = \mu^* Q - \mu_* Q + 2\varepsilon = \\ &= \mu^* Q - \mu_* Q + (\mu_* Q - \mu^* Q) = 0. \end{aligned}$$

Keyingi tengsizlikdan $\mu A_0 > \mu B_0$ bo'lishi kelib chiqadi. Bu esa (1) munosabatga zid. Demak, (2) tengsizlik o'rinli bo'ladi. ►

1- ta'rif. Agar $\mu_*Q = \mu^*Q$ tenglik o'rinli bo'lsa, Q shakl yuzaga ega deyiladi. Ushbu $\mu_*Q = \mu^*Q$ miqdor Q shaklning yuzi deyiladi. Uni μQ kabi belgilanadi:

$$\mu Q = \mu_*Q = \mu^*Q.$$

1- teorema. Tekislikdagi shakl yuzaga ega bo'lishi uchun $\forall \varepsilon > 0$ soni olinganda ham Q shaklni ichiga joylashgan shunday A ko'pburchak, Q shaklni ichiga olgan shunday B ko'pburchak topilib, ular uchun

$$\mu A - \mu B < \varepsilon \quad (3)$$

tengsizlikning bajarilishi zarur va yetarli.

◀ **Zarurligi.** Aytaylik, tekislikdagi Q shakl yuzaga ega bo'lsin:

$$\mu Q = \mu_*Q = \mu^*Q.$$

Aniq chegara ta'riflariga ko'ra, $\forall \varepsilon > 0$ uchun shunday

$$A \subset \bar{Q}, \quad \bar{Q} \subset B$$

ko'pburchak topiladiki, bunda

$$\mu A > \mu_*Q - \frac{\varepsilon}{2}, \quad \mu B < \mu^*Q + \frac{\varepsilon}{2},$$

ya'ni
$$\mu A > \mu Q - \frac{\varepsilon}{2}, \quad \mu B < \mu Q + \frac{\varepsilon}{2}$$

bo'ladi. Bu tengsizlikdan

$$\mu B - \mu A < \varepsilon$$

bo'lishi kelib chiqadi.

Yetarliligi. Aytaylik, $A \subset \bar{Q}$, $\bar{Q} \subset B$ ko'pburchaklar uchun

$$\mu B - \mu A < \varepsilon$$

tengsizlik bajarilsin. Ravshanki,

$$\mu A \leq \mu_*Q, \quad \mu B \geq \mu^*Q.$$

Yuqoridagi (2) munosabatdan foydalanib topamiz:

$$\mu A \leq \mu_*Q \leq \mu^*Q \leq \mu B.$$

Bu va (3) tengsizlikka ko'ra

$$\mu^*Q - \mu_*Q \leq \mu B - \mu A < \varepsilon$$

bo'ladi. Demak, $\mu_*Q = \mu^*Q$. ►

Faraz qilaylik, tekislikda l chiziq (u yopiq yoki yopiq bo'lmisligi mumkin) berilgan bo'lsin.

2- tarif. Agar shunday A_0 ko'pburchak topilsaki,

1) $l \subset A_0$,

2) $\forall \varepsilon > 0$ uchun $\mu A_0 < \varepsilon$ bo'lsa, l nol yuzali chiziq deyiladi.

Masalan, l chiziq $y = f(x) \in C[a, b]$ funksiyaning grafigidan iborat bo'lsa, u nol yuzali chiziq bo'ladi.

◀ $\forall \varepsilon > 0$ sonni olib $[a, b]$ segmentni shunday $[x_k, x_{k+1}]$ ($k = 0, 1, 2, \dots, n-1$; $x_0 = a, x_n = b$) bo'laklarga ajratamizki, har bir $[x_k, x_{k+1}]$ da $f(x)$ funksiyaning tebranishi

$$\omega_k < \frac{\varepsilon}{b-a}$$

bo'lsin. U holda l chiziqni o'z ichiga olgan A_0 ko'pburchakning yuzi

$$\mu A_0 = \sum_{k=0}^{n-1} (M_k - m_k)(x_{k+1} - x_k)$$

bo'ladi, bunda

$$M_k = \sup f(x), \quad x \in [x_k, x_{k+1}], \quad (k = 0, 1, \dots, n-1),$$

$$m_k = \inf f(x), \quad x \in [x_k, x_{k+1}], \quad (k = 0, 1, \dots, n-1).$$

Ravshanki,
$$\mu A_0 = \sum_{k=0}^{n-1} \omega_k \Delta x_k < \frac{\varepsilon}{b-a} \sum_{k=0}^{n-1} \Delta x_k = \varepsilon.$$

Demak, l – nol yuzali chiziq. ▶

Bu tushuncha yordamida yuqoridagi 1- teoremani quyidagicha ifodalasa bo'ladi.

2- teorema. Tekislikdagi Q shakl yuzaga ega bo'lishi uchun uning chegarasi ∂Q nol yuzali chiziq bo'lishi zarur va yetarli.

Natija. Agar tekislikdagi Q shaklning chegarasi ∂Q , har biri

$$y = f(x) \in C[a, b] \quad \text{yoki} \quad x = g(y) \in C[a, b]$$

funksiyalar tasvirlangan bir necha egri chiziqlardan tashkil topgan bo'lsa, u holda Q shakl yuzaga ega bo'ladi.

Odatda, uzunlikka ega bo'lgan egri chiziq *to'g'rilanuvchi chiziq* deyiladi. Quyida Q tekis shaklning yuzaga ega bo'lishining yetarli shartini ifodalovchi teoremani isbotsiz keltiramiz.

3- teorema. Agar Q tekis shaklning chegarasi ∂Q to'g'rilanuvchi egri chiziq bo'lsa, u Q yuzaga ega bo'ladi.

2°. Yuzaning xossalari. Endi yuzaning asosiy xossalari keltiramiz.

1) Agar tekislikdagi Q_1 va Q_2 shakllar yuzaga ega bo'lib, $\bar{Q}_1 \subset \bar{Q}_2$ bo'lsa, u holda

$$\mu Q_1 \leq \mu Q_2$$

bo'ladi.

2) Agar Q_1 va Q_2 tekis shakllar yuzaga ega bo'lsa, u holda $Q_1 \cup Q_2$ ham yuzaga ega va

$$\mu(Q_1 \cup Q_2) \leq \mu Q_1 + \mu Q_2$$

bo'ladi. Agar bu Q_1 va Q_2 shakllar chegaralaridan boshqa umumiy nuqtaga ega bo'lmasa, ya'ni $Q_1 \cap Q_2 = \emptyset$ bo'lsa, u holda $\mu(Q_1 \cup Q_2) = \mu Q_1 + \mu Q_2$ bo'ladi. Bu *yuzaning additivlik xossasi* deyiladi.

3°. Tekis shaklni bo'laklash. Tekislikda biror yuzaga ega bo'lgan Q shakl berilgan bo'lib,

$$Q_1 Q_2 \dots Q_n$$

shakllar uning yuzaga ega bo'lgan qisman shakllari, yani

$$Q_k \in \bar{Q}, \quad (k = 1, 2, \dots, n)$$

bo'lsin. Agar $Q_1 Q_2 \dots Q_n$ lar uchun

$$1) Q_1 \cup Q_2 \cup \dots \cup Q_n = \bar{Q},$$

2) ixtiyoriy Q_k va Q_i lar ($k = 1, 2, \dots, n; i = 1, 2, \dots, n$) umumiy nuqtaga (chegaralaridagi nuqtalardan boshqa) ega bo'lmasa, u holda $Q_1 Q_2 \dots Q_n$ lar Q da bo'laklash bajaradi yoki Q shakl $Q_1 Q_2 \dots Q_n$ shakllarga bo'laklangan deyiladi.

Q shaklni $Q_1 Q_2 \dots Q_n$ larga bo'laklashni P bilan belgilanadi:

$$P = \{Q_1 Q_2 \dots Q_n\}.$$

Ushbu

$$d(Q_k) = \sup \rho((x', y'), (x'', y'')),$$

$$(x', y') \in Q_k, (x'', y'') \in Q_k, \quad (k = 1, 2, \dots, n)$$

miqdorlarning eng kattasi P bo'laklashning diametri deyiladi va λ_p kabi belgilanadi:

$$\lambda_p = \max_{1 \leq k \leq n} d(Q_k).$$

Masalan, ushbu

$$Q_{ki} = \{(x, y) \in R^2 : x_k \leq x \leq x_{k+1}, y_i \leq y \leq y_{i+1}\}$$

$$(k = 0, 1, \dots, n-1; i = 0, 1, \dots, m-1; x_0 = a, x_n = b, y_0 = c, y_m = d)$$

to'g'ri to'rtburchaklar

$$Q = \{(x, y) \in R^2 : a \leq x \leq b, c \leq y \leq d\}$$

tekis shaklning P bo'laklashini hosil qiladi. Bunda

$$\lambda_p = \max_{\substack{1 \leq k \leq n-1 \\ 0 \leq i \leq m-1}} \sqrt{\Delta x_k^2 + \Delta y_i^2}$$

bo'ladi.

4°. R^3 fazoda jismning hajmi. R^3 fazoda Dekart koordinatalar sistemasi berilgan bo'lsin. Bu fazoda, chegaralangan yopiq sirt bilan (yoki bunday sirtlarning bir nechtasi bilan) o'ralgan V jismni (R^3 fazo qismini) qaraylik. V jismni o'rab turuvchi sirtini — V , jismning chegarasini ∂V bilan, $V \cup \partial V$ ni \bar{V} bilan belgilaymiz:

$$\bar{V} = V \cup \partial V.$$

Masalan, koordinatalari ushbu

$$x^2 + y^2 + z^2 < 1$$

tengsizlikni qanoatlantiruvchi (x, y, z) nuqtalardan tashkil topgan

$$S = \{(x, y, z) \in R^3 : x^2 + y^2 + z^2 < 1\}$$

to'plam, markazi $(0, 0, 0)$, radiusi 1 ga teng bo'lgan sharni — jismni ifodalaydi. Uning chegarasi esa

$$\partial S = \{(x, y, z) \in R^3 : x^2 + y^2 + z^2 = 1\}$$

sfera bo'ladi. Bunday jism — shar hajmga ega va quyidagiga teng:

$$\mu V = \frac{4}{3} \pi.$$

Umuman, fazoda ko'pyoqliklarning hajmga ega bo'lishi va uni topish qoidalari o'quvchiga o'rta maktab matematika kursidan ma'lum.

Endi R^3 fazoda V jism bilan birga F va G ko'pyoqliklarni qaraylik.

Agar F ko'pyoqlikning har bir nuqtasi \bar{V} ga tegishli bo'lsa, F ko'pyoqlik V jismning ichiga joylashgan deyiladi (bunda $F \subset \bar{V}$ bo'ladi). Agar \bar{V} ning har bir nuqtasi G ko'pyoqlikka tegishli bo'lsa, G ko'pyoqlik V jismni o'z ichiga oladi deyiladi (bunda $\bar{V} \subset G$).

Agar μF va μG lar mos ravishda F va G ko'pyoqliklarning hajmlari bo'lsa, u holda

$$\mu F \leq \mu G$$

tengsizlik bajariladi.

Aytaylik, V jismda joylashgan ko'pyoqliklar hajmlaridan iborat $\{\mu F\}$ to'plam, V jismni o'z ichiga olgan ko'pyoqliklar hajmlaridan iborat $\{\mu G\}$ to'plam bo'lsin. U holda

$$\sup\{\mu E\} = \mu \cdot V, \quad \inf\{\mu G\} = \mu^* V$$

lar mavjud.

3- ta'rif. Agar

$$\mu \cdot V = \mu^* V$$

tenglik o'rinli bo'lsa, jism hajmga ega deyiladi. Ushbu

$$\mu \cdot V = \mu^* V$$

miqdor V jismning hajmi deyiladi. Uni μV kabi belgilanadi:

$$\mu \cdot V = \mu^* V = \mu V.$$

Tekis shaklning yuzi, fazodagi jismning hajmi tushunchalarida bir-biriga o'xshashlik borligini inobatga olib, jism hajmining mavjudligi haqidagi teoremani keltirish bilan kifoyalanamiz.

4- teorema. Fazodagi V jism hajmga ega bo'lishi uchun $\forall \varepsilon > 0$ son olinganda ham V jismning ichida joylashgan shunday F ko'pyoqlik, V jismni o'z ichiga olgan shunday G ko'pyoqlik topilib, ular uchun $\mu G - \mu F < \varepsilon$ tengsizlikning bajarilishi zarur va yetarli.

Mashqlar

1. Aytaylik, $f(x) \in C[a, b]$ bo'lib, $\forall x \in [a, b]$ da $f(x) \geq 0$ bo'lsin. Bu funksiya grafigi — $x = a$, $x = b$ chiziqlar hamda $[a, b]$ kesma bilan chegaralangan shakl yuzaga ega bo'lishi isbotlansin.

2. Tekislikda Q shakl berilgan bo'lib, $\{A_n\}$ va $\{B_n\}$ ko'pburchaklar ketma-ketligi uchun $A_n \subset \bar{Q}$, $B_n \subset \bar{Q}$ ($n = 1, 2, \dots$) bo'lsin. U holda Q shakl yuzaga ega bo'lishi $\lim_{n \rightarrow \infty} A_n = \lim_{n \rightarrow \infty} B_n$ tenglikning bajarilishi

orqali ifodalanishi mumkinmi?

82- ma'ruza

Ikki karrali integral tushunchasi va uning mavjudligi

1°. Funksiyaning integral va Darbu yig'indilari. Faraz qilaylik, tekislikda yuzaga ega bo'lgan D shakl (to'plam) berilgan bo'lsin. Bu to'plamda $f(x, y)$ funksiya aniqlangan va chegaralangan:

$$\exists M = \text{const}, \exists m = \text{const}, \forall (x, y) \in D, m \leq f(x, y) \leq M.$$

D ning biror

$$P = \{D_1, D_2, \dots, D_n\}$$

bo'laklanishi va har bir D_k da ixtiyoriy $(\xi_k, \eta_k) \in D_k$ nuqtani ($k = 1, 2, \dots, n$) olib quyidagi

$$\sum_{k=1}^n f(\xi_k, \eta_k) \mu D_k$$

yig'indini tuzamiz.

1- ta'rif. Ushbu
$$\sigma = \sum_{k=1}^n f(\xi_k, \eta_k) \mu D_k$$

yig'indi $f(x, y)$ funksiyaning integral yig'indisi (Riman yig'indisi) deyiladi.

Keltirilgan ta'rifdan ko'rinadiki, integral yig'indi $f(x, y)$ funksiya, D to'plam va uni bo'laklash usuliga hamda har bir $(\xi_k, \eta_k) \in D_k$ nuqtalarga bog'liq bo'ladi:

$$\sigma = \sigma_p(f, \xi_k, \eta_k).$$

Modomiki, $f(x, y)$ funksiya D da chegaralangan ekan, u har bir D_k da ($k = 1, 2, \dots, n$) ham chegaralangan bo'ladi. Demak,

$$m_k = \inf\{f(x, y) : (x, y) \in D_k\},$$

$$M_k = \sup\{f(x, y) : (x, y) \in D_k\}$$

mavjud. Ayni paytda, $\forall (x, y) \in D_k$ uchun

$$m_k \leq f(x, y) \leq M_k \tag{1}$$

tengsizliklar bajariladi.

2- ta'rif. Ushbu

$$s = \sum_{k=1}^n m_k \mu D_k, \quad S = \sum_{k=1}^n M_k \mu D_k$$

yig'indilar mos ravishda *Darbutning quyi* hamda *yuqori yig'indilari* deyiladi.

Funksiyaning Darbu yig'indilari $f(x,y)$ funksiyaga, D to'plam va uning bo'laklashiga bog'liq:

$$s = s_p(f), \quad S = S_p(f)$$

bo'lib, har doim $s \leq S$ tengsizlik bajariladi. (1) tengsizlikdan foydalanib topamiz:

$$\sum_{k=1}^n m_k \mu D_k \leq \sum_{k=1}^n f(\xi_k, \eta_k) \mu D_k \leq \sum_{k=1}^n M_k \mu D_k.$$

Demak, $s \leq \sigma \leq S$.

2°. Ikki karrali integral ta'riflari. Aytaylik, $f(x,y)$ funksiya yuzaga ega bo'lgan D to'plamda aniqlangan va chegaralangan bo'lsin. D ning

$$P = \{D_1, D_2, \dots, D_n\}$$

bo'laklashini olib, berilgan funksiyaning integral yig'indisini tuzamiz:

$$\sigma = \sum_{k=1}^n f(\xi_k, \eta_k) \mu D_k.$$

3- ta'rif. Agar $\forall \varepsilon > 0$ son olinganda ham shunday $\delta > 0$ son topilsaki, D ning diametri $\lambda_p < \delta$ bo'lgan har qanday P bo'laklash hamda har bir D_k da olingan ixtiyoriy (ξ_k, η_k) lar uchun

$$|\sigma - J| < \varepsilon$$

tengsizlik bajarilsa, J son σ yig'indining $\lambda_p \rightarrow 0$ dagi limiti deyiladi va

$$\lim_{\lambda_p \rightarrow 0} \sigma = J$$

kabi belgilanadi.

4- ta'rif. Agar $\lambda_p \rightarrow 0$ da $f(x,y)$ funksiyaning integral yig'indisi limiti mavjud va chekli J ga teng bo'lsa, $f(x,y)$ funksiya D da integrallanuvchi deyiladi. J soniga esa $f(x,y)$ funksiyaning D bo'yicha ikki karrali integrali deyiladi. Uni quyidagicha

$$\iint_D f(x,y) dx dy$$

kabi belgilanadi. Demak,

$$\iint_D f(x, y) dx dy = \lim_{\lambda_p \rightarrow 0} \sigma = \lim_{\lambda_p \rightarrow 0} \sum_{k=1}^n f(\xi_k, \eta_k) \mu D_k.$$

Masalan, $f(x, y) = C = \text{const}$ bo'lsin. Bu funksiyaning integral yig'indisi

$$\sigma = \sum_{k=1}^n C \mu D_k = C \mu D$$

bo'lib, uning ikki karrali integrali

$$\iint_D C dx dy = \lim_{\lambda_p \rightarrow 0} C \mu D = C \mu D$$

bo'ladi. Xususan, $C = 1$ bo'lganda quyidagiga ega bo'lamiz:

$$\iint_D 1 dx dy = \mu D.$$

Funksiyaning ikki karrali integrali yuqori hamda quyi integrallar yordamida ham ta'riflanishi mumkin.

Faraz qilaylik, $f(x, y)$ funksiya yuzaga ega bo'lgan D to'plamda berilgan va chegaralangan bo'lsin. D ning turli bo'laklashlaridan tashkil topgan to'plamni $\{P\}$ deylik: $P = \{D_1, D_2, \dots, D_n\}$.

Har bir $P \in \{P\}$ bo'laklashga nisbatan $f(x, y)$ funksiyaning Darbu yig'indilarini tuzib, ushbu $\{s_p(f)\}$, $\{S_p(f)\}$ to'plamlarni hosil qilamiz. Bu to'plamlar chegaralangan bo'ladi.

5- ta'rif. $\{s_p(f)\}$ to'plamning aniq yuqori chegarasi $f(x, y)$ funksiyaning quyi ikki karrali integrali deyiladi va

$$\underline{J} = \iint_D f(x, y) dx dy$$

kabi belgilanadi. Demak,

$$\underline{J} = \iint_D f(x, y) dx dy = \sup_{P \in \{P\}} (s_p(f)) = \sup_{P \in \{P\}} \left(\sum_{k=1}^n m_k \mu D_k \right).$$

6- ta'rif. $\{S_p(f)\}$ to'plamning aniq quyi chegarasi $f(x, y)$ funksiyaning yuqori ikki karrali integrali deyiladi va

$$\bar{J} = \iint_D f(x, y) dx dy$$

kabi belgilanadi. Demak,

$$\bar{J} = \iint_D f(x, y) dx dy = \inf_{P \in \{P\}} (S_p(f)) = \inf_{P \in \{P\}} \left(\sum_{k=1}^n M_k \mu D_k \right).$$

Demak, chegaralangan $f(x, y)$ funksiyaning har doim quyi hamda yuqori integrali mavjud bo'ladi.

7- ta'rif. Agar $\bar{J} = \underline{J}$

bo'lsa, $f(x, y)$ funksiya D to'plamda integrallanuvchi, ularning umumiy qiymati $J = \bar{J} = \underline{J}$ esa $f(x, y)$ funksiyaning D bo'yicha ikki karrali integrali deyiladi. Demak,

$$\iint_D f(x, y) dx dy = \bar{J} = \underline{J}.$$

Eslatma. Agar $\bar{J} \neq \underline{J}$ bo'lsa, $f(x, y)$ funksiya D da integrallanmaydi.

3°. Darbu yig'indilarining xossalari. Aytaylik, $f(x, y)$ funksiya yuzaga ega bo'lgan D to'plamda berilgan va chegaralangan bo'lsin. D to'plamning bo'laklashlari to'plami $\mathcal{P} = (P)$ dagi $P = \{D_1, D_2, \dots, D_n\}$ bo'laklashga nisbatan $f(x, y)$ funksiyaning integral hamda Darbu yig'indilarini kiritamiz:

$$\sigma_p(f; \xi_k, \eta_k) = \sum_{k=1}^n f(\xi_k, \eta_k) \mu D_k,$$

$$s_p(f) = \sum_{k=1}^n m_k \mu D_k, \quad S_p(f) = \sum_{k=1}^n M_k \mu D_k,$$

bunda $m_k = \inf \{f(x, y) : (x, y) \in D_k\}$,

$$M_k = \sup \{f(x, y) : (x, y) \in D_k\}$$

bo'lib, $\forall (x, y) \in D_k$ uchun quyidagi ifoda o'rinli:

$$m_k \leq f(x, y) \leq M_k.$$

Ma'lumki, 33- ma'ruzada $f(x)$ funksiya Darbu yig'indilarining xossalari keltirilib, ular batafsil isbotlangan edi.

Xuddi shunday xossalalar $f(x,y)$ funksiya Darbu yig'indilari uchun ham o'rinli bo'ladi. Ular avvalgidek mulohaza asosida isbotlanishini e'tiborga olib, mos xossalarni keltirish bilan kifoyalanamiz.

1) $\forall \varepsilon > 0$ olinganda ham $(\xi_k, \eta_k) \in D_k$ nuqtalarni ($k=1,2,\dots,n$) shunday tanlab olish mumkinki,

$$0 \leq S_p(f) - \sigma_p(f; \xi_k, \eta_k) < \varepsilon,$$

shuningdek, $(\xi_k, \eta_k) \in D_k$ nuqtalarni yana shunday tanlab olish mumkinki,

$$0 \leq \sigma_p(f; \xi_k, \eta_k) - s_p(f) < \varepsilon$$

bo'ladi. Bu xossa Darbu yig'indilari integral yig'indi uchun aniq yuqori va aniq quyi chegara bo'lishini bildiradi.

2) Aytaylik, $P_1 = \{D_1, D_2, \dots, D_{k-1}, D_k, D_{k+1}, \dots, D_n\}$,

$$P_2 = \{D_1, D_2, \dots, D_{k-1}, D'_k, D''_k, D_{k+1}, \dots, D_n\}$$

lar D to'plamning bo'laklashlari bo'lib,

$$D_k = D'_k \cup D''_k, \quad D'_k \cap D''_k = \emptyset$$

bo'lsin. U holda

$$s_{p_1} \leq s_{p_2}(f), \quad S_{p_2}(f) \leq S_{p_1}(f)$$

bo'ladi. Bu xossa D ning bo'laklashdagi bo'laklar soni orta borganda ularga mos Darbuning quyi yig'indisining kamaymasligi, yuqori yig'indisining esa oshmasligini bildiradi.

3) Agar P_1 va P_2 lar D ning ikki bo'laklashi bo'lib, $s_{p_1}(f)$, $S_{p_1}(f)$ va $s_{p_2}(f)$, $S_{p_2}(f)$ lar $f(x,y)$ funksiyaning shu bo'laklashlarga nisbatan Darbu yig'indilari bo'lsa, u holda

$$s_{p_1} \leq S_{p_2}, \quad s_{p_2}(f) \leq S_{p_1}(f)$$

bo'ladi.

Bu xossa, D ning bo'laklashlariga nisbatan tuzilgan quyi yig'indilar to'plami $\{s_p(f)\}$ ning har bir elementi (yuqori yig'indilar to'plami $\{S_p(f)\}$ ning har bir elementi) yuqori yig'indilari to'plami $\{S_p(f)\}$ ning istalgan elementidan (quyi yig'indilar to'plami $\{s_p(f)\}$ ning istalgan elementidan) katta (kichik) emasligini bildiradi.

4) Ushbu

$$\sup \{s_p(f)\} \leq \inf \{S_p(f)\}$$

munosabat o'rinli. Bu xossa $f(x,y)$ funksiyaning quyi ikki karrali integrali, uning yuqori ikki karrali integralidan katta emasligini bildiradi:

$$\underline{J} \leq \bar{J}.$$

5) $\forall \varepsilon > 0$ olinganda ham shunday $\delta > 0$ topiladiki, D ning diametri $\lambda_p < \delta$ bo'lgan barcha bo'laklari uchun

$$0 \leq S_p(f) - \bar{J} < \varepsilon, \quad 0 \leq \underline{J} - s_p(f) < \varepsilon$$

bo'ladi. Bu xossa $f(x,y)$ funksiyaning yuqori hamda quyi integrallari $\lambda_p \rightarrow 0$ da mos ravishda Darbuning yuqori hamda quyi yig'indilari ning limiti ekanligini bildiradi.

4°. Ikki karrali integralning mavjudligi. $f(x,y)$ funksiyaning Darbu yig'indilari va ularning xossalardan foydalanib, ikki karrali integralning mavjudligi haqidagi teoremani keltiramiz.

Aytaylik, yuzaga ega bo'lgan D to'plamda $f(x,y)$ funksiya berilgan va chegaralangan bo'lsin.

1- teorema. $f(x,y)$ funksiya to'plamda integrallanuvchi bo'lishi uchun, $\forall \varepsilon > 0$ son olinganda ham, shunday $\delta > 0$ soni topilib, D ning diametri $\lambda_p > \delta$ bo'lgan har qanday P bo'laklashiga nisbatan Darbu yig'indilari ushbu

$$S_p(f) - s_p(f) < \varepsilon \quad (2)$$

tengsizlikni qanoatlantirishi zarur va yetarli.

◀ **Zarurligi.** Faraz qilaylik, $f(x,y)$ funksiya D da integrallanuvchi bo'lsin. Ta'rifga ko'ra $J = \bar{J} = \underline{J}$ bo'ladi, bunda

$$\underline{J} = \sup_P (s_p(f)) = \sup_P \left(\sum_{k=q}^n m_k \mu D_k \right),$$

$$\bar{J} = \inf_P (S_p(f)) = \inf_P \left(\sum_{k=q}^n M_k \mu D_k \right).$$

Ayni paytda, Darbu yig'indilarining 5- xossasiga ko'ra

$$\forall \varepsilon > 0, \quad \exists \delta > 0, \quad \lambda_p < \delta, \quad \forall p \in (P):$$

$$S_p(f) - \bar{J} < \frac{\varepsilon}{2}, \quad \underline{J} - s_p(f) < \frac{\varepsilon}{2}$$

va $J = \bar{J} = \underline{J}$ bo'lgani uchun

$$S_p(f) - J < \frac{\varepsilon}{2}, \quad J - s_p(f) < \frac{\varepsilon}{2}$$

tengsizliklar o'rinli bo'ladi. Keyingi tengsizliklardan

$$S_p(f) - s_p(f) < \varepsilon$$

bo'lishi kelib chiqadi.

Yetarliliigi. Aytaylik, $\forall \varepsilon > 0, \exists \delta > 0, \lambda_p < \delta, \forall p \in (P)$:

$$S_p(f) - s_p(f) < \varepsilon$$

bo'lsin, $f(x,y)$ funksiya D da chegaralanganligi uchun

$$\sup \{s_p(f)\} = \underline{J}, \quad \inf \{S_p(f)\} = \bar{J}$$

mavjud bo'lib, Darbu yig'indilarining 4- xossasiga ko'ra $\underline{J} \leq \bar{J}$ bo'ladi. Demak,

$$s_p(f) \leq \underline{J} \leq \bar{J} \leq S_p(f).$$

Bu tengsizliklar va (2) shartdan foydalanib topamiz:

$$0 \leq \bar{J} - \underline{J} \leq S_p(f) - s_p(f) < \varepsilon.$$

Demak, $\underline{J} \leq \bar{J}$. $f(x,y)$ funksiya D da integrallanuvchi. ►

Aytaylik, D ning $P = \{D_1, D_2, \dots, D_n\}$ bo'laklashning D_k bo'lagida ($k = 1, 2, \dots, n$) $f(x,y)$ funksiyaning tebranishi

$$\omega_k = \sup \{f(x,y) : (x,y) \in D_k\} - \inf \{f(x,y) : (x,y) \in D_k\}$$

bo'lsin. Unda $f(x,y)$ funksiyaning D da integrallanuvchi bo'lish sharti

$$\sum_{k=1}^n \omega_k \mu D_k < \varepsilon, \quad (3)$$

ya'ni

$$\lim_{\lambda_p \rightarrow 0} \sum_{k=1}^n \omega_k \mu D_k = 0 \quad (4)$$

ko'rinishlarga keladi.

Demak, $f(x,y)$ funksiyaning D to'plamda integrallanuvchi bo'lishini isbotlash uchun (2), (3), (4) shartlardan birining bajarilishini ko'rsatish yetarli bo'ladi.

Mashqlar

1. Ushbu $D = \{(x, y) \in R^2 : 0 \leq x \leq 1, 0 \leq y \leq 1\}$ to'plam (tekislikdagi kvadrat)

$$x = x_i = \frac{i}{n}, \quad i = 1, 2, 3, \dots, n, \quad y = y_k = \frac{k}{n}, \quad k = 1, 2, 3, \dots, n$$

chiziqlar yordamida D_{ik} larga bo'laklangan. Shu bo'laklashning diametri topilsin.

2. Yuqoridagi D to'plam va uning $P = \{D_{ik}; i, k = 1, 2, \dots, n\}$ bo'laklashga nisbatan $f(x, y) = x^2 + y^2$ funksiyaning

a) Darbu yig'indilari,

b) har bir D_{ik} da $\xi_i = \frac{i}{n}$, $\eta_k = \frac{k}{n}$ deb, integral yig'indisi topilsin.

3. Aytaylik, D – tekislikdagi yuzaga ega bo'lgan to'plam bo'lsin. Ushbu

$$g(x, y) = \begin{cases} 1, & \text{agar } (x, y) \in D, x \in Q, y \in Q \text{ bo'lsa,} \\ 0, & \text{agar } (x, y) \in D, x \text{ va } y \end{cases}$$

larning kamida bittasi irratsional bo'lsa, funksiyaning D da integrallanuvchi bo'lmasligi isbotlansin.

4. $f(x, y)$ funksiya yuzaga ega bo'lgan D to'plamda chegaralangan bo'lib, \bar{J} va \underline{J} lar mos ravishda funksiyaning yuqori va quyi ikki karrali integrallari bo'lsa, $\underline{J} \leq \bar{J}$ bo'lishi isbotlansin.

5. $f(x, y)$ funksiyaning Darbu yig'indilari uchun

$$\lim_{\lambda_p \rightarrow 0} S_p(f) = \bar{J}, \quad \lim_{\lambda_p \rightarrow 0} s_p(f) = \underline{J}$$

bo'lishi isbotlansin.

83- ma'ruza

Integrallanuvchi funksiyalar sinfi. Integralning asosiy xossalari

1°. Uzlüksiz funksiyalarning integrallanuvchi bo'lishi. Uzlüksiz funksiyalarning integrallanuvchi bo'lishini quyidagi teorema ifodalaydi.

1- teorema. Agar $f(x, y)$ funksiya chegaralangan yopiq D to'plamda uzlüksiz bo'lsa, u shu to'plamda integrallanuvchi bo'ladi.

◀ Ixtiyoriy $\varepsilon > 0$ sonni olaylik. $f(x,y)$ funksiya chegaralangan yopiq D da uzluksiz. Binobarin, funksiya D da tekis uzluksiz. U holda

$$\frac{\varepsilon}{\mu D} > 0$$

songa ko'ra, shunday $\delta > 0$ son topiladiki, D ning diametri $\lambda_p > \delta$ bo'lgan

$$P = \{D_1, D_2, \dots, D_n\}$$

bo'laklashning har bir D_k bo'lagida ($k = 1, 2, \dots, n$) $f(x,y)$ funksiyaning tebranishi ω_k uchun

$$\omega_k < \frac{\varepsilon}{\mu D}$$

tengsizlik bajariladi.

Shunday P bo'laklashlarga nisbatan

$$S_p(f) - s_p(f) = \sum_{k=1}^n \omega_k \mu D_k < \frac{\varepsilon}{\mu D} \sum_{k=1}^n \mu D_k = \varepsilon$$

bo'ladi. Demak, $f(x,y)$ funksiya D da integrallanuvchi.

2°. Uzilishga ega bo'lgan funksiyaning integrallanuvchi bo'lishi.

Ba'zi bir uzilishga ega bo'lgan funksiyaning integrallanuvchi bo'lishi haqidagi teoremani keltirishdan avval bitta sodda tasdiqni bayon etamiz.

Aytaylik, tekislikda yuzaga ega bo'lgan D to'plam berilgan bo'lib, l esa shu to'plamga tegishli nol yuzali chiziq bo'lsin.

Tasdiq. $\forall \varepsilon > 0$ son olinganda ham shunday $\delta > 0$ topiladiki, D ning diametri $\lambda_p > \delta$ bo'lgan $\forall P \in \mathcal{P}$ bo'laklash olinganda, bu bo'laklashning l chiziq bilan umumiy nuqtaga ega bo'lgan bo'lakchalari yuzalarining yig'indisi ε dan kichik bo'ladi.

◀ l chiziq nol yuzali bo'lganligi uchun shunday A ko'pburchak topiladiki,

1) $l \subset A$,

2) $\forall \varepsilon > 0$ uchun $\mu A < \varepsilon$ bo'ladi. Aytaylik, $l \cap \partial A = \emptyset$ bo'lsin. l chiziq nuqtalari bilan ∂A nuqtalari orasidagi masofaning eng kichigini δ ($\delta > 0$) deylik. U holda $\lambda_p > \delta$ bo'lgan $\forall P \in \mathcal{P}$ bo'laklashning l chiziq bilan umumiy nuqtaga ega bo'lgan burchaklari A ko'pburchakka tegishli bo'ladi. Binobarin, bunday bo'lakchalar yuzalarining yig'indisi ε dan kichik bo'ladi. ▶

2- teorema. Agar $f(x,y)$ chegaralangan yopiq D da berilgan bo'lib, bu to'plamga tegishli chekli sondagi nol yuzali chiziqalarda uzilishga ega, qolgan barcha nuqtalarda uzluksiz bo'lsa, $f(x,y)$ funksiya D da integrallanuvchi bo'ladi.

◀ Sodda uchun $f(x,y)$ funksiya D dagi bitta nol yuzali l chiziqda uzilishga ega, qolgan barcha nuqtalarda uzluksiz deylik.

Ixtiyoriy $\varepsilon > 0$ sonni olamiz. U holda $l \subset A$, $\mu A < \varepsilon$ bo'lgan A ko'pburchak ($A \subset D$) D ni A va $D \setminus A$ qismlarga ajratadi.

Ravshanki, $f(x,y)$ funksiya $D \setminus A$ da tekis uzluksiz. U holda $\forall \varepsilon > 0$ ga ko'ra shunday $\delta_1 > 0$ topiladiki, D ning diametri $\lambda_p > \delta_1$ bo'lgan P bo'laklashining har bir bo'lakchasida $f(x,y)$ funksiyaning tebranishi quyidagicha bo'ladi:

$$\omega_k < \varepsilon .$$

Yuqoridagi tasdiqqa binoan va $\forall \varepsilon > 0$ ga ko'ra shunday $\delta_2 > 0$ topiladiki, D ning diametri $\lambda_p > \delta_2$ bo'lgan P bo'laklashining A ko'pburchak bilan umumiy nuqtaga ega bo'lgan bo'lakchalari yuzalari yig'indisi ε dan kichik bo'lishini topamiz.

$$\text{Endi} \quad \delta = \min \{ \delta_1, \delta_2 \}$$

deb, diametri $\lambda_p > \delta$ bo'lgan D ning

$$P = \{ D_1, D_2, \dots, D_n \}$$

bo'laklashini olib, unga nisbatan tuzilgan Darbu yig'indilari ayirmasi

$$S_p(f) - s_p(f) = \sum_{k=1}^n \omega_k \mu D_k \quad (1)$$

ni qaraymiz.

(1) tenglikning o'ng tomonidagi yig'indi n ta haddan iborat. Uni ikki qismga ajratamiz:

$$\sum_{k=1}^n \omega_k \mu D_k = \sum' \omega_k \mu D_k + \sum'' \omega_k \mu D_k ,$$

bunda $\sum' \omega_k \mu D_k$ ifoda — P bo'laklash bo'lakchasi D_k larning A ko'pburchakdan tashqarisida joylashganlariga mos (1) ning hadlaridan

iborat yig'indi, $\sum'' \omega_k \mu D_k$ esa (1) ning qolgan barcha hadlaridan tashkil topgan yig'indi.

Yuqorida aytilganlarni e'tiborga olib topamiz:

$$S_p(f) - s_p(f) \leq \varepsilon \sum' \mu D_k + \sum'' \Omega \mu D_k \leq \varepsilon \sum_{k=1}^n \mu D_k + \Omega \cdot 2\varepsilon = \varepsilon(\mu D + 2\Omega).$$

Bunda Ω – funksiya $f(x,y)$ ning D dagi tebranishi. Keyingi tengsizlikdan

$$\lim_{\lambda_p \rightarrow 0} \sum_{k=1}^n \omega_k \mu D_k = 0$$

bo'lishi kelib chiqadi. Demak, $f(x,y)$ funksiya D da integrallanuvchi. ►

3'. Ikki karrali integralning xossalari. Ikki karrali integral ham [1], 35- ma'ruzada batafsil bayon etilgan aniq integralning xossalari singari qator xossalarga ega. Shuni ham aytish kerakki, ularni isbotlash jarayonlaridagi mulohazalar bir-biriga o'xshash bo'ladi. Shularni e'tiborga olib, quyida keltiriladigan xossalarning ba'zilarini isbotlash yo'l-yo'riqlarini, ba'zilarini esa isbotsiz keltirish bilan kifoyalnamiz.

1) Faraz qilaylik, $f(x,y)$ funksiya D to'plamda integrallanuvchi bo'lsin. Agar D nol yuzali l chiziq bilan umumiy ichki nuqtaga ega bo'lmagan bog'lamlari D_1 va D_2 to'plamlarga ajralgan bo'lsa, $f(x,y)$ funksiya har bir D_1 va D_2 larda integrallanuvchi va

$$\iint_D f(x,y) dx dy = \iint_{D_1} f(x,y) dx dy + \iint_{D_2} f(x,y) dx dy \quad (2)$$

bo'ladi.

◀ Aytaylik,

$$P_1 = \{D_1^{(1)}, D_1^{(2)}, \dots, D_1^{(n)}\}, \quad P_2 = \{D_2^{(1)}, D_2^{(2)}, \dots, D_2^{(m)}\}$$

lar mos ravishda D_1 va D_2 larning bo'laklashlari bo'lsin. Bu bo'laklashlar D to'plamning

$$P = \{D_1^{(1)}, D_2^{(1)}, D_1^{(2)}, D_2^{(2)}, \dots, D_1^{(n)}, D_2^{(m)}\}$$

bo'laklashlarini hosil qiladi. Agar

$$s_{p_1}(f), S_{p_1}(f), s_{p_2}(f), S_{p_2}(f), s_p(f), S_p(f)$$

lar $f(x,y)$ funksiyaning P_1, P_2, P bo'laklashlariga nisbatan Darbu yig'indilari bo'lsa, u holda

$$D_1 \subset D \Rightarrow S_{p_1}(f) - s_{p_1}(f) \leq S_p(f) - s_p(f),$$

$$D_2 \subset D \Rightarrow S_{p_2}(f) - s_{p_2}(f) \leq S_p(f) - s_p(f)$$

bo'lib, quyidagi ifodaga ega bo'lamiz:

$$S_p(f) - s_p(f) < \varepsilon \Rightarrow S_{p_1}(f) - s_{p_1}(f) < \varepsilon, S_{p_2}(f) - s_{p_2}(f) < \varepsilon.$$

Demak, $f(x,y)$ funksiya D_1 va D_2 to'plamlarda integrallanuvchi. Ushbu

$$S_p(f) = S_{p_1}(f) + S_{p_2}(f), \quad s_p(f) = s_{p_1}(f) + s_{p_2}(f)$$

tengliklarni e'tiborga olib,

$$\iint_D f(x,y) dx dy = \iint_{D_1} f(x,y) dx dy + \iint_{D_2} f(x,y) dx dy$$

bo'lishini topamiz. ►

Yuqoridagi xossaning aksi ham o'rinli, ya'ni $f(x,y)$ funksiya har bir D_1 va D_2 to'plamlarda integrallanuvchi bo'lsa, u D da integrallanuvchi bo'lib, (2) tenglik o'rinli bo'ladi.

2) Agar $f(x,y)$ funksiya D da integrallanuvchi bo'lsa, $cf(x,y)$ funksiya ($c = \text{const}$) ham D da integrallanuvchi va

$$\iint_D cf(x,y) dx dy = c \iint_D f(x,y) dx dy$$

bo'ladi. Bu xossaning isboti ushbu

$$\lim_{\lambda_p \rightarrow 0} \sum_{k=1}^n cf(\xi_k, \eta_k) \mu D_k = c \lim_{\lambda_p \rightarrow 0} \sum_{k=1}^n f(\xi_k, \eta_k) \mu D_k$$

tenglikdan kelib chiqadi.

3) Agar $f(x,y)$ va $g(x,y)$ funksiyalar D da integrallanuvchi bo'lsa, $f(x,y) \pm g(x,y)$ funksiya ham D da integrallanuvchi va

$$\iint_D [f(x,y) \pm g(x,y)] dx dy = \iint_D f(x,y) dx dy \pm \iint_D g(x,y) dx dy$$

bo'ladi.

4) Agar $f(x,y)$ funksiya D da integrallanuvchi bo'lib, $\forall (x,y) \in D$ da $f(x,y) \geq 0$ bo'lsa,

$$\iint_D f(x,y) dx dy \geq 0$$

ga ega bo'lamiz. Bu xossaning isboti

$$\lim_{\lambda_p \rightarrow 0} \sum_{k=1}^n f(\xi_k, \eta_k) \mu D_k \geq 0$$

bo'lishidan kelib chiqadi.

5) Agar $f(x,y)$ va $g(x,y)$ funksiyalar D da integralanuvchi bo'lib, $\forall (x,y) \in D$ uchun $f(x,y) \leq g(x,y)$ bo'lsa, u holda

$$\iint_D f(x,y) dx dy \leq \iint_D g(x,y) dx dy$$

bo'ladi.

◀ Bu xossaning isboti $g(x,y) - f(x,y)$ funksiyaga 5- xossani tatbiq etish va 3- xossadan foydalanish natijasida kelib chiqadi. ▶

6) Agar $f(x,y)$ funksiya D da integrallanuvchi bo'lsa, u holda $|f(x,y)|$ funksiya ham D da integrallanuvchi va quyidagi ifoda o'rinni bo'ladi:

$$\left| \iint_D f(x,y) dx dy \right| \leq \iint_D |f(x,y)| dx dy .$$

4°. O'rta qiymat haqidagi teoremlar. Aytaylik, $f(x,y)$ funksiya yuzaga ega bo'lgan D to'plamda berilgan va chegaralangan bo'lsin:

$$\exists M = \text{const}, \exists m = \text{const}, \forall (x,y) \in D: m \leq f(x,y) \leq M .$$

3- teorema. Agar $f(x,y)$ funksiya D da integrallanuvchi bo'lsa, u holda, shunday α son ($m \leq \alpha \leq M$) topiladiki, bunda

$$\iint_D f(x,y) dx dy = \alpha \mu D$$

bo'ladi.

◀ Yuqorida keltirilgan ikki karrali integralning xossalardan foydalanib topamiz:

$$m \leq f(x,y) \leq M \Rightarrow \frac{1}{\mu D} \iint_D f(x,y) dx dy = \alpha \Rightarrow \iint_D f(x,y) dx dy = \alpha \mu D,$$

$$(m \leq \alpha \leq M) . \blacktriangleright$$

Bu teoremdan quyidagi natija kelib chiqadi.

Natija. Agar $f(x,y)$ funksiya bog'lamli yopiq D to'plamda uzluksiz bo'lsa, u holda shunday $(\xi, \eta) \in D$ nuqta topiladiki,

$$\iint_D f(x,y) dx dy = f(\xi, \eta) \mu D$$

bo'ladi.

4- teorema. Agar $f(x,y)$ va $g(x,y)$ funksiyalar D to'plamda integrallanuvchi bo'lib, $\forall (x,y) \in D$ uchun $g(x,y) \geq 0$ (yoki $g(x,y) \leq 0$) bo'lsa, u holda shunday α son ($m \leq \alpha \leq M$) topiladiki, bunda

$$\iint_D f(x,y)g(x,y)dxdy = \alpha \iint_D g(x,y)dxdy$$

bo'ladi.

Mashqlar

1. Agar $f(x,y)$ funksiya chegaralangan yopiq $D \subset R^2$ to'plamda chegaralanmagan bo'lsa, uning D da integrallanuvchi bo'lmisligi isbotlansin.

2. Agar $f(x,y)$ funksiya $D \subset R^2$ da integrallanuvchi bo'lsa, $|f(x,y)|$ funksiyaning ham D da integrallanuvchi bo'lishi ko'rsatilsin.

3. Ma'lumki, ushbu

$$M[f] = \frac{1}{\mu D} \iint_D f(x,y)dxdy$$

miqdor $f(x,y)$ funksiyaning D dagi o'rta qiymati deyiladi.

Quyidagi

$$f(x,y) = \sin^2 x \sin^2 y$$

funksiyaning $D = \{(x,y) \in R^2 : 0 \leq x \leq \pi, 0 \leq y \leq \pi\}$ dagi o'rta qiymati topilsin.

4. Ushbu $-\frac{\pi}{2} < \iint_D (x^2 - y^2) dxdy < 4\pi$ tengsizliklar isbotlansin,

bunda $D = \{(x,y) \in R^2 : x^2 + y^2 - 2x \leq 0\}$.

84- ma'ruza

Ikki karrali integralni hisoblash

1°. To'g'ri to'rtburchak to'plam bo'yicha ikki karrali integrallarni hisoblash. $f(x,y)$ funksiya tekislikdagi $D = \{(x,y) \in R^2 : a \leq x \leq b, c \leq y \leq d\}$ to'plamda berilgan bo'lsin. Bu $f(x,y)$ funksiyaning D bo'yicha ikki karrali integralini hisoblash masalasini qaraymiz.

1- teorema. $f(x,y)$ funksiya quyidagi shartlarni bajarsin:

1) $f(x,y)$ funksiya D da integrallanuvchi;

2) Har bir tayin $x \in [a, b]$ da

$$J(x) = \int_a^b f(x, y) dy$$

integral mavjud.

U holda $J(x)$ funksiya $[a, b]$ da integrallanuvchi, ya'ni

$$\int_a^b J(x) dx = \int_a^b \left[\int_c^d f(x, y) dy \right] dx$$

mavjud va

$$\iint_D f(x, y) dx dy = \int_a^b \left[\int_c^d f(x, y) dy \right] dx$$

bo'ladi.

◀ $[a, b]$ segmentning

$$a = x_0 < x_1 < x_2 < \dots < x_n = b,$$

$[c, d]$ segmentning

$$c = y_0 < y_1 < y_2 < \dots < y_m = d$$

nuqtalari yordamida D uchun ushbu

$$P = \{D_{ik}\} = \{(x, y) \in R^2 : x_i \leq x \leq x_{i+1}, y_k \leq y \leq y_{k+1}\},$$

$$(i = 0, 1, 2, \dots, n-1; k = 0, 1, 2, \dots, m-1)$$

bo'laklashni hosil qilamiz. Uning diametri

$$\lambda_p = \max \sqrt{\Delta x_i^2 + \Delta y_k^2},$$

$$(\Delta x_i = x_{i+1} - x_i, \Delta y_k = y_{k+1} - y_k; i = 0, 1, 2, \dots, n-1; k = 0, 1, 2, \dots, m-1)$$

bo'ladi. Aytaylik,

$$m_{ik} = \inf \{f(x, y) : (x, y) \in D_{ik}\},$$

$$M_{ik} = \sup \{f(x, y) : (x, y) \in D_{ik}\},$$

$$(i = 0, 1, 2, \dots, n-1; k = 0, 1, 2, \dots, m-1)$$

bo'lsin. Ravshanki, $\forall (x, y) \in D_{ik}$ uchun

$$m_{ik} \leq f(x, y) \leq M_{ik}$$

bo'lib,
$$\int_{y_k}^{y_{k+1}} m_{ik} dy \leq \int_{l_k}^{y_{k+1}} f(x, y) dy \leq \int_{y_k}^{y_{k+1}} M_{ik} dy,$$

ya'ni
$$m_{ik} \Delta y_k \leq \int_{l_k}^{y_{k+1}} f(x, y) dy \leq M_{ik} \Delta y_k$$

bo'ladi.

Keyingi tengsizlikni k ning $k = 0, 1, 2, \dots, m-1$ qiymatlari uchun yozish, so'ngra ularni hadlab qo'shish natijasida

$$\sum_{k=0}^{m-1} m_{ik} \Delta y_k \leq \int_c^d f(x, y) dy \leq \sum_{k=0}^{m-1} M_{ik} \Delta y_k \quad (2)$$

hosil bo'ladi. Ushbu
$$\int_c^d f(x, y) dy$$

integral x ning
$$F(x) = \int_c^d f(x, y) dy$$

funksiyasi bo'lib, bu funksiya $[a, b]$ da, jumladan, $[x_i, x_{i+1}]$ da chegaralangan bo'ladi. Agar

$$m_i = \inf \{F(x), x \in [x_i, x_{i+1}]\},$$

$$M_i = \sup \{F(x), x \in [x_i, x_{i+1}]\}, \quad (i = 0, 1, 2, 3, \dots, n-1)$$

deyilsa, (2) munosabatga ko'ra

$$\sum_{k=0}^{m-1} m_{ik} \Delta y_k \leq m_i \leq M_i \leq \sum_{k=0}^{m-1} M_{ik} \Delta y_k$$

bo'lib, undan

$$0 \leq M_i - m_i \leq \sum_{k=0}^{m-1} (M_{ik} - m_{ik}) \Delta y_k$$

bo'lishi kelib chiqadi. Bu tengsizlikni Δx_k ga ko'paytirib, so'ngra

hosil bo'lgan tengsizlikni i ning $i = 0, 1, \dots, n-1$ qiymatlarida yozib, ularni hadlab qo'shib topamiz:

$$0 \leq \sum_{i=0}^{n-1} (M_i - m_i) \Delta x_k \leq \sum_{i=0}^{n-1} \sum_{k=0}^{m-1} (M_{ik} - m_{ik}) \mu D_k = S_p(f) - s_p(f).$$

Modomiki, $f(x, y)$ funksiya D da integrallanuvchi ekan, u holda $\lambda_p \rightarrow 0$ da $(\max_i \Delta x_k \rightarrow 0)$ da

$$\sum_{i=0}^{n-1} (M_i - m_i) \Delta x_k \rightarrow 0$$

bo'ladi. Bu esa $F(x) = \int_c^d f(x, y) dy$

funksiyaning $[a, b]$ da integrallanuvchi ekanini bildiradi.

$$\text{Demak, } \int_a^b F(x, y) dx = \int_a^b \left[\int_c^d f(x, y) dy \right] dx$$

integral mavjud.

(2) tengsizlikni $[x_i, x_{i+1}]$ oraliq bo'yicha hadlab integrallab topamiz:

$$\begin{aligned} \int_{x_i}^{x_{i+1}} \sum_{k=0}^{m-1} m_{ik} \Delta y_k dx &\leq \int_{x_i}^{x_{i+1}} \left[\int_c^d f(x, y) dy \right] dx \leq \int_{x_i}^{x_{i+1}} \sum_{k=0}^{m-1} M_{ik} \Delta y_k dx \Rightarrow \\ \sum_{i=0}^{n-1} \sum_{k=0}^{m-1} m_{ik} \Delta x_i \Delta y_k &\leq \int_a^b \left[\int_c^d f(x, y) dy \right] dx \leq \sum_{i=0}^{n-1} \sum_{k=0}^{m-1} M_{ik} \Delta x_i \Delta y_k, \end{aligned}$$

$$\text{ya'ni } s_p(f) \leq \int_a^b \left[\int_c^d f(x, y) dy \right] dx \leq S_p(f) \quad (3)$$

munosabatga kelamiz. Ravshanki,

$$s_p(f) \leq \iint_D f(x, y) dx dy \leq S_p(f) \quad (4)$$

$$\text{va } S_p(f) - s_p(f) < \varepsilon.$$

U holda (3) va (4) munosabatlardan

$$\iint_D f(x, y) dx dy = \int_a^b \left[\int_c^d f(x, y) dy \right] dx$$

bo'lishi kelib chiqadi. ►

2- teorema. $f(x, y)$ funksiya quyidagi shartlarni bajarsin:

- 1) $f(x, y)$ funksiya D da integrallanuvchi,
- 2) har bir tayin $y \in [c, d]$ da

$$J(y) = \int_a^b f(x, y) dx$$

integral mavjud.

U holda $J(y)$ funksiya $[c, d]$ da integrallanuvchi, ya'ni

$$\int_c^d J(y) dy = \int_c^d \left[\int_a^b f(x, y) dx \right] dy$$

mavjud va $\iint_D f(x, y) dx dy = \int_c^d \left[\int_a^b f(x, y) dx \right] dy$ bo'ladi.

◀ Bu teoremaning isboti yuqoridagi teoremaning isboti kabidir. ►

1- natija. $f(x, y)$ quyidagi shartlarni qanoatlantirsin:

- 1) $f(x, y)$ funksiya D da integrallanuvchi;

- 2) har bir tayin $x \in [a, b]$ da $\int_c^d f(x, y) dy$ integral mavjud;

- 3) har bir tayin $y \in [c, d]$ da $\int_a^b f(x, y) dx$ integral mavjud. U

holda

$$\int_a^b \left[\int_c^d f(x, y) dy \right] dx, \quad \int_c^d \left[\int_a^b f(x, y) dx \right] dy$$

integrallar mavjud va

$$\iint_D f(x, y) dx = \int_a^b \left[\int_c^d f(x, y) dy \right] dx = \int_c^d \left[\int_a^b f(x, y) dx \right] dy$$

bo'ladi.

2- natija. Agar $f(x, y)$ funksiya D da uzluksiz bo'lsa, u holda

$$\iint_D f(x, y) dx dy, \quad \int_a^b \left[\int_c^d f(x, y) dy \right] dx, \quad \int_c^d \left[\int_a^b f(x, y) dx \right] dy$$

integrallar mavjud va ular bir-biriga teng bo'ladi. Demak, integrallash to'plami

$$D = \{(x, y) \in R^2 : a \leq x \leq b, c \leq y \leq d\}$$

bo'lgan holda $f(x, y)$ funksiyaning D bo'yicha integrali avval birinchi argumenti (ikkinchi argumentini o'zgarimas deb hisoblab), so'ngra ikkinchi argumenti bo'yicha integrallab topiladi.

1- misol. Ushbu $\iint_D x^2 y dx dy$ integral hisoblansin, bunda $D = \{(x, y) \in R^2 : 2 \leq x \leq 5, 1 \leq y \leq 3\}$.

◀ Integrallanayotgan $f(x, y) = x^2 y$ funksiya 1- va 2- teoremlar shartlarini bajaradi. Ulardan foydalanib topamiz:

$$\begin{aligned} \iint_D x^2 y dx dy &= \int_1^3 \left[\int_2^5 x^2 y dx \right] dy = \int_1^3 \left(\frac{x^3 y}{3} \right)_{x=2}^{x=5} dy = \\ &= \frac{1}{3} \int_1^3 (125y - 8y) dy = \frac{117}{3} \left(\frac{y^2}{2} \right)_1^3 = 156. \end{aligned}$$

Shuningdek,

$$\begin{aligned} \iint_D x^2 y dx dy &= \int_2^5 \left[\int_1^3 x^2 y dy \right] dx = \int_2^5 \left(\frac{x^2 y^2}{2} \right)_{y=1}^{y=3} dx = \\ &= \frac{1}{2} \int_2^5 (9x^2 - x^2) dx = 4 \left(\frac{x^3}{3} \right)_2^5 = 156 \end{aligned}$$

bo'ladi. ►

2°. Egri chiziqli trapesiya bo'yicha ikki karrali integrallarni hisoblash. $f(x,y)$ funksiya tekislikdagi

$$D_1 = \{(x,y) \in R^2 : a \leq x \leq b, \varphi_1(x) \leq y \leq \varphi_2(x)\}$$

to'plamda berilgan bo'lsin, bunda $\varphi_1(x)$, $\varphi_2(x)$ funksiyalar $[a,b]$ da uzluksiz va $\forall x \in (a,b)$ da $\varphi_1(x) < \varphi_2(x)$.

3- teorema. $f(x,y)$ funksiya quyidagi shartlarni bajarsin:

- 1) $f(x,y)$ funksiya D da integrallanuvchi;
- 2) har bir tayin $x \in [a,b]$ da

$$\int_{\varphi_1(x)}^{\varphi_2(x)} f(x,y) dy$$

integral mavjud. U holda

$$\int_a^b \left[\int_{\varphi_1(x)}^{\varphi_2(x)} f(x,y) dy \right] dx$$

mavjud va quyidagi ifoda o'rinli bo'ladi:

$$\iint_{D_1} f(x,y) dx dy = \int_a^b \left[\int_{\varphi_1(x)}^{\varphi_2(x)} f(x,y) dy \right] dx.$$

◀ Aytaylik, $D = \{(x,y) \in R^2 : a \leq x \leq b, c \leq y \leq d\}$ to'g'ri to'rt-burchak D_1 ni o'z ichiga joylashtirsin: $D_1 \subset D$ (34- chizma).

Ushbu

$$F(x,y) = \begin{cases} f(x,y), & \text{agar } (x,y) \in D_1 \text{ bo'lsa,} \\ 0, & \text{agar } (x,y) \in D \setminus D_1 \text{ bo'lsa} \end{cases}$$

funksiya uchun, ravshanki,

$$\iint_{D_1} f(x,y) dx dy = \iint_D F(x,y) dx dy \quad (5)$$

tenglik bajariladi.

Agar $F(x,y)$ funksiya har bir tayin $x \in [a,b]$ da y o'zgaruvchining funksiyasi sifatida qaralsa, u holda teoremaning 2- sharti hamda $F(x,y)$ funksiyaning tuzilishidan

$$\int_c^d F(x, y) dy$$

integralning mavjudligini topamiz.
Unda 1- teoreмага ko'ra

$$\begin{aligned} \iint_D F(x, y) dx dy &= \\ &= \int_a^b \left[\int_c^d F(x, y) dy \right] dx \end{aligned}$$

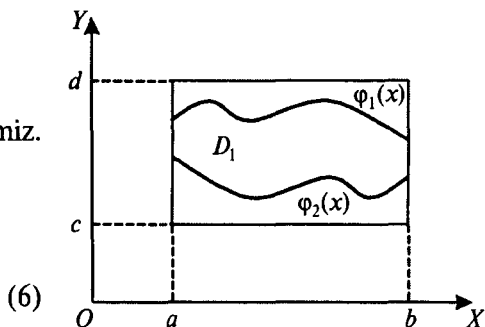

34- chizma.

bo'ladi. Ayni paytda, har bir tayin $x \in [a, b]$ da

$$\begin{aligned} \int_c^d F(x, y) dy &= \int_c^{\varphi_1(x)} F(x, y) dy + \int_{\varphi_1(x)}^{\varphi_2(x)} F(x, y) dy + \int_{\varphi_2(x)}^d F(x, y) dy = \\ &= \int_{\varphi_1(x)}^{\varphi_2(x)} F(x, y) dy = \int_{\varphi_1(x)}^{\varphi_2(x)} f(x, y) dy \end{aligned} \quad (7)$$

bo'ladi. (5), (6) va (7) munosabatlardan

$$\iint_{D_1} F(x, y) dx dy = \int_a^b \left[\int_{\varphi_1(x)}^{\varphi_2(x)} f(x, y) dy \right] dx$$

bo'lishi kelib chiqadi. ►

Aytaylik, $f(x, y)$ funksiya tekislikdagi

$$D_2 = \{(x, y) \in R^2 : \psi_1(y) \leq x \leq \psi_2(y), c \leq y \leq d\}$$

to'plamda berilgan bo'lsin, bunda $\psi_1(y)$ va $\psi_2(y)$ funksiyalar $[c, d]$ da uzluksiz va $\forall y \in (c, d)$ da $\psi_1(y) < \psi_2(y)$.

4- teorema. $f(x, y)$ funksiya quyidagi shartlarni bajarsin:

- 1) $f(x, y)$ funksiya D_2 da integrallanuvchi;
- 2) har bir tayin $y \in [c, d]$ da

$$\int_{\psi_1(y)}^{\psi_2(y)} f(x, y) dx$$

integral mavjud. U holda

$$\int_c^d \left[\int_{\psi_1(y)}^{\psi_2(y)} f(x, y) dx \right] dy$$

mavjud va quyidagi ifoda o'rinli bo'ladi:

$$\iint_{D_2} f(x, y) dx dy = \int_c^d \left[\int_{\psi_1(y)}^{\psi_2(y)} f(x, y) dx \right] dy.$$

◀ Bu teoremaning isboti 3-teoremaning isboti kabidir. ▶

Agar $f(x, y)$ funksiya D^* da kerakli shartlarni bajarib, integrallash to'plami D^* esa nol yuzali chiziqlar yordamida o'zaro bir-biri bilan ichki umumiy nuqtaga ega bo'lmasa hamda yuqoridagi teoremalardagi kabi

$$D^* = D_1^* \cup D_2^* \cup \dots \cup D_k^*$$

bo'lsa, u holda quyidagi tenglik kelib chiqadi:

$$\begin{aligned} \iint_{D^*} f(x, y) dx dy &= \iint_{D_1^*} f(x, y) dx dy + \iint_{D_2^*} f(x, y) dx dy + \dots \\ &+ \iint_{D_k^*} f(x, y) dx dy. \end{aligned}$$

2- misol. Ushbu $J = \iint_D \sqrt{x+y} dx dy$

integrallar hisoblansin, bunda D – quyidagi

$$x = 0, \quad y = 0, \quad x + y = 1$$

chiziqlar bilan chegaralangan to'plam.

◀ Bu chiziqlar bilan chegaralangan to'plam 35- chizmada tasvirlangan.

$f(x, y) = \sqrt{x+y}$ funksiya va D to'plam 3- teoremaning shartlarini bajaradi. Endi

$$D = \{(x, y) \in R^2: 0 \leq x \leq 1, 0 \leq y \leq 1 - x\}$$

ekanini e'tiborga olib topamiz:

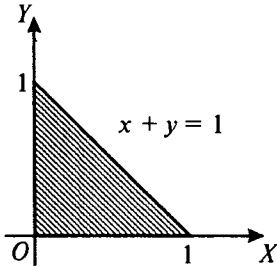

35- chizma.

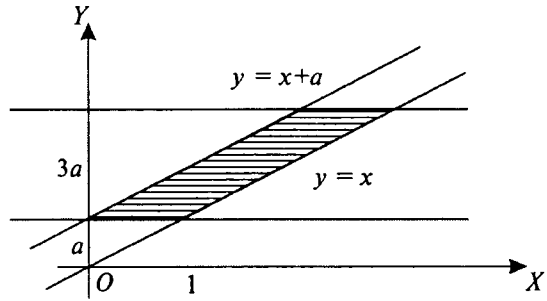

36- chizma.

$$\begin{aligned}
 J &= \int_0^1 \left[\int_0^{1-x} \sqrt{x+y} dy \right] dx = \int_0^1 \frac{2}{3} \left[(x+y)^{\frac{3}{2}} \right]_{y=0}^{y=1-x} dx = \frac{2}{3} \int_0^1 \left(1 - x^{\frac{3}{2}} \right) dx = \\
 &= \frac{2}{3} \left(x - \frac{2}{5} x^{\frac{5}{2}} \right) \Big|_0^1 = \frac{2}{3} \left(1 - \frac{2}{5} \right) = \frac{2}{5}. \blacktriangleright
 \end{aligned}$$

3- misol. Ushbu $J = \iint_D (x^2 + y^2) dx dy$

integral hisoblansin, bunda D quyidagi

$$y = x, y = x + a, y = a, y = 3a, (a > 0)$$

chiziqlar bilan chegaralangan to'plam.

◀ Bu chiziqlar bilan chegaralangan to'plam 36- chizmada tasvirlangan.

Berilgan integralni hisoblashda 4- teoremdan foydalanamiz:

$$\begin{aligned}
 J &= \int_a^{3a} \left[\int_{y-a}^y (x^2 + y^2) dx \right] dy = \int_a^{3a} \left(\frac{y^2}{3} - \frac{(y-a)^3}{3} + y^2 (y-a) \right) dy = \\
 &= \frac{81a^4}{12} - \frac{16a^4}{12} + \frac{27a^4}{3} - \frac{a^4}{12} - \frac{a^4}{3} = 14a^4. \blacktriangleright
 \end{aligned}$$

4- misol. Ushbu $J = \iint_D dx dy$ integral hisoblansin, bunda D — quyidagi chiziqlar:

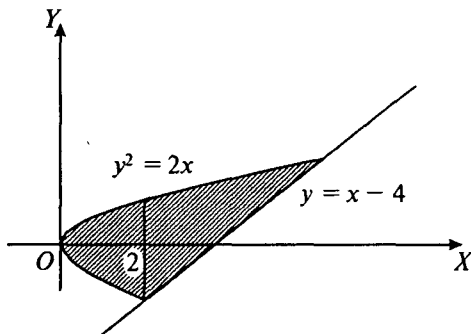

37- chizma.

$y^2 = 2x$ parabola va uning $(2; -2)$ va $(8; 4)$ nuqtalarini birlashtiruvchi vatar bilan chegaralangan to'plam.

◀ $y^2 = 2x$ parabolaning $(2; -2)$ va $(8; 4)$ nuqtalarini birlashtiruvchi vatar tenglamasi

$$y = x - 4$$

ko'rinishda bo'ladi. $y^2 = 2x$ va $y = x - 4$ chiziqlar bilan chegaralangan D to'plam 37- chizmada tasvirlangan.

$x = 2$ to'g'ri chiziq yordamida D to'plamni ikkita D_1 va D_2 larga ajratamiz. Bunda:

$$D_1 = \{(x, y) \in R^2 : 0 \leq x \leq 2, -\sqrt{2x} \leq y \leq \sqrt{2x}\},$$

$$D_2 = \{(x, y) \in R^2 : 2 \leq x \leq 8, x - 4 \leq y \leq \sqrt{2x}\}.$$

Ikki karrali integralning xossalaridan foydalanib topamiz:

$$\iint_D dx dy = \iint_{D_1} dx dy + \iint_{D_2} dx dy.$$

Bu integrallarni hisoblaymiz:

$$\begin{aligned} \iint_D dx dy &= \iint_{D_1} dx dy + \iint_{D_2} dx dy = \int_0^2 \left[\int_{-\sqrt{2x}}^{\sqrt{2x}} dy \right] dx + \int_2^8 \left[\int_{x-4}^{\sqrt{2x}} dy \right] dx = \\ &= \int_0^2 2\sqrt{2x} dx + \int_2^8 (\sqrt{2x} - x + 4) dx = 18. \quad \blacktriangleright \end{aligned}$$

Mashqlar

1. Ushbu $\iint_D \sin \frac{x^2 - y + 1}{x^2 + y^2 + 1} dx dy$ integral baholansin, bunda

$$D = \{(x, y) \in \mathbb{R}^2 : x^2 + y^2 \leq 9\}.$$

2. Ushbu $\iint_D f(x, y) dx dy$ integral takroriy integralga keltirilsin,

bunda D to'plam $x^2 + y^2 = 4$ va $x^2 - 2x + y^2 = 0$ aylanalar bilan chegaralangan.

3. Ushbu $\iint_D \frac{dx dy}{(1 + x^2 + y^2)^2}$ integral hisoblansin, bunda

$$D = \{(x, y) \in \mathbb{R}^2 : 0 \leq x \leq 1, 0 \leq y \leq 1 - x\}.$$

85- ma'ruza

Ikki karrali integralda o'zgaruvchilarni almashtirish

Ikki karrali integrallarni hisoblashda ancha qiyinchiliklarga duch kelinadi. Bu qiyinchiliklar:

1) integrallanuvchi funksiyalarning murakkabligi;

2) integrallash to'plamining murakkabligi hisobiga sodir bo'ladi.

Ba'zan o'zgaruvchilarni almashtirish natijasida integrallanuvchi funksiya ham, integrallash to'plami ham soddaroq ko'rinishga (integrallash uchun qulay ko'rinishga) keladi va integralni hisoblash osonlashadi.

1°. Tekislikda to'plamlarni akslantirish haqida. Faraz qilaylik, tekislikda XOY dekart koordinatalar sistemasiga nisbatan chegaralangan D to'plam, uOv dekart koordinatalar sistemasiga nisbatan esa chegaralangan Δ to'plam berilgan bo'lib, ularning chegaralari ∂D va $\partial \Delta$ lar bo'lakli-silliqlik yopiq chiziqlardan iborat bo'lsin (38- chizma).

Aytaylik,

$$\begin{cases} x = \varphi(u, v), \\ y = \psi(u, v) \end{cases} \quad (1)$$

sistema Δ ni D ga akslantirsin. Bu akslantirish quyidagi shartlarni bajarsin:

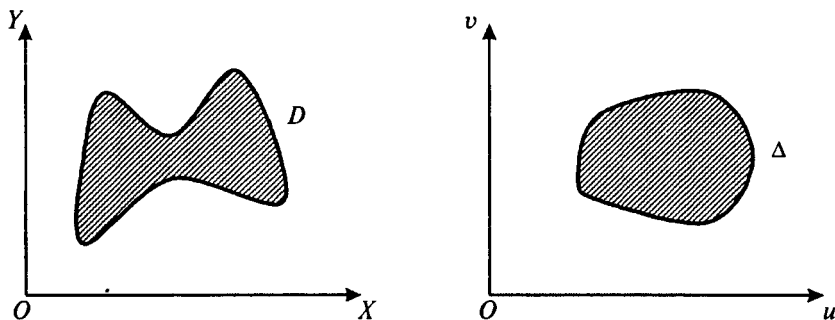

38- chizma.

- 1) bu o'zaro bir qiymatli akslantirish;
- 2) $\varphi(u, v)$ va $\psi(u, v)$ funksiyalar Δ to'plamda uzluksiz va uzluksiz barcha xususiy hosilalarga ega;
- 3) xususiy hosilalardan tuzilgan

$$J(u, v) = \begin{vmatrix} \frac{\partial x}{\partial u} & \frac{\partial x}{\partial v} \\ \frac{\partial y}{\partial u} & \frac{\partial y}{\partial v} \end{vmatrix}$$

funktional determinant Δ da ishora saqlasin va $\forall (u, v) \in \Delta$ da $J(u, v) \neq 0$ bo'lsin.

Odatda, $J(u, v)$ *determinant (1) sistemaning yakobiani* deyiladi. Ravshanki, bunday holda (1) akslantirishga teskari

$$\begin{cases} u = \varphi(x, y), \\ v = \psi(x, y) \end{cases}$$

akslantirish mavjud va u D ni Δ ga bir qiymatli akslantiradi.

Tasdiq. D to'plamning yuzi

$$\mu D = \iint_{\Delta} |J(u, v)| du dv$$

bo'ladi (qaralsin, [1], 19- bob, 3- §).

2°. Ikki karrali integrallarda o'zgaruvchilarni almashtirish. $f(x, y)$ funksiya D to'plamda berilgan va uzluksiz bo'lsin. Ushbu

$$\begin{cases} x = \varphi(u, v), \\ y = \psi(u, v) \end{cases} \quad (2)$$

sistema Δ ni D ga akslantirib, u 1° da keltirilgan 1–3- shartlarni bajarsin.
 D ning biror

$$P_{\Delta} = (\Delta_1, \Delta_2, \dots, \Delta_n)$$

bo‘laklanishi olaylik. Bu bo‘laklash (1) akslantirish yordamida D to‘p-
lamning

$$P_D = (D_1, D_2, \dots, D_n)$$

bo‘laklashlarini hosil qiladi.

Ikki karrali integral ta’rifiga ko‘ra

$$\sigma = \sum_{k=1}^n f(\xi_k, \eta_k) \mu D_k, \quad ((\xi_k, \eta_k) \in D_k)$$

bo‘lib,

$$\lim_{\lambda_{pD} \rightarrow 0} \sigma = \lim_{\lambda_{pD} \rightarrow 0} \sum_{k=1}^n f(\xi_k, \eta_k) \mu D_k = \iint_D f(x, y) dx dy \quad (3)$$

bo‘ladi.

1° da keltirilgan tasdiqdan foydalanib topamiz:

$$\mu D_k = \iint_{\Delta_k} |J(u, v)| du dv.$$

O‘rta qiymat haqidagi teorema binoan, shunday

$$(u_k^*, v_k^*) \in \Delta_k$$

nuqta topiladiki, bunda

$$\int_D |J(u, v)| du dv = |J(u_k^*, v_k^*)| \mu D_k$$

tenglik bajariladi.

Natijada $f(x, y)$ funksiyaning integral yig‘indisi quyidagi

$$\sigma = \sum_{k=1}^n f(\xi_k, \eta_k) |J(u_k^*, v_k^*)| \mu \Delta_k$$

ko‘rinishga keladi. $(\xi_k, \eta_k) \in D_k$ nuqtaning ixtiyoriyligidan

$$\xi_k = (u_k^*, v_k^*), \quad \eta_k = (u_k^*, v_k^*)$$

deb olish mumkin. U holda

$$\sigma = \sum_{k=1}^n f(\varphi(u_k^*, v_k^*), \psi(u_k^*, v_k^*)) |J(u_k^*, v_k^*)| \mu \Delta_k$$

bo'ladi. $f(\varphi(u, v), \psi(u, v)) |J(u, v)|$ funksiya Δ da uzluksiz, bino-
barin, integrallanuvchi. Demak,

$$\begin{aligned} \lim_{\lambda_{\rho\Delta} \rightarrow 0} \sigma &= \lim_{\lambda_{\rho\Delta} \rightarrow 0} \sum_{k=1}^n f(\varphi(u_k^*, v_k^*), \psi(u_k^*, v_k^*)) |J(u_k^*, v_k^*)| \mu \Delta_k = \\ &= \iint_{\Delta} f(\varphi(u, v), \psi(u, v)) |J(u, v)| dudv \end{aligned} \quad (4)$$

bo'ladi. (2) va (3) munosabatlardan

$$\iint_D f(x, y) = \iint_{\Delta} f(\varphi(u, v), \psi(u, v)) |J(u, v)| dudv \quad (5)$$

bo'lishi kelib chiqadi.

(5) ifoda ikki karrali integrallarda o'zgaruvchilarni almashtirish
formulasidir.

1- misol. Ushbu
$$\iint_D y^3 dx dy$$

integral hisoblansin. D quyidagi $y = x^2$, $y = 2x^2$, $xy = 1$, $xy = 2$
chiziqlar bilan chegaralangan.

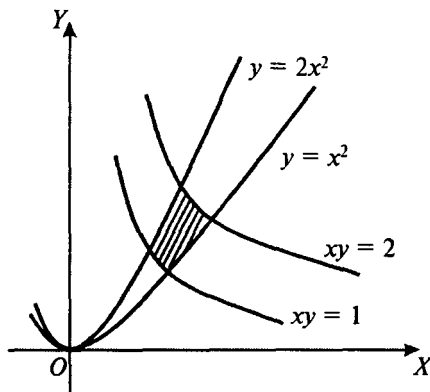

39- chizma.

◀ Berilgan chiziqlar bilan che-
garalangan D to'plam 39- chiz-
mada tasvirlangan.

Ushbu

$$\begin{cases} u = \frac{y}{x^2}, \\ v = xy, \end{cases} \quad (x > 0) \quad (6)$$

akslantirishda \bar{D} ning aksi:

$$\Delta = \{(u, v) \in \mathbb{R}^2 : 1 \leq u \leq 2, 1 \leq v \leq 2\}.$$

Ravshanki, (5) akslantirish o'zaro bir qiymatli akslantirish bo'lib, unga teskari akslantirish quyidagicha:

$$\begin{cases} x = u^{-\frac{1}{3}}v^{\frac{1}{3}}, \\ y = u^{\frac{1}{3}}v^{\frac{2}{3}}. \end{cases} \quad (6')$$

(6) sistemaning yakobianini topamiz:

$$J(u, v) = \begin{vmatrix} \frac{\partial x}{\partial u} & \frac{\partial x}{\partial v} \\ \frac{\partial y}{\partial u} & \frac{\partial y}{\partial v} \end{vmatrix} = \begin{vmatrix} -\frac{1}{3}u^{-\frac{4}{3}}v^{\frac{1}{3}} & \frac{1}{3}u^{-\frac{2}{3}}v^{\frac{2}{3}} \\ \frac{2}{3}u^{\frac{1}{3}}v^{-\frac{2}{3}} & \frac{2}{3}u^{\frac{1}{3}}v^{-\frac{1}{3}} \end{vmatrix} = -\frac{1}{3u}, \quad |J(u, v)| = \frac{1}{3|u|}.$$

Endi $y^3 = uv^2$ ekanini e'tiborga olib, berilgan integralda (6') almashtirish bajarsak, u holda (5) formulaga ko'ra

$$\iint_D y^3 dx dy = \iint_D uv^2 |J(u, v)| du dv$$

bo'ladi. Keyingi integralni hisoblaymiz:

$$\iint_D uv^2 |J(u, v)| du dv = \frac{1}{3} \iint_D v^2 du dv = \frac{1}{3} \int_1^2 \left(\int_1^2 v^2 dv \right) du = \frac{1}{3} \left(\frac{8}{3} - \frac{1}{3} \right) = \frac{7}{9}.$$

Demak,
$$\iint_D y^3 dx dy = \frac{7}{9}. \blacktriangleright$$

3°. Ikki karrali integralning qutb koordinatalarida ifodalanishi. Yuqoridagi (1) sistema sifatida ushbu

$$\begin{cases} x = r \cos \varphi, \\ y = r \sin \varphi \end{cases} \quad (7)$$

akslantirishni olaylik. Bu tekislikdagi qutb koordinatalari sistemasi bo'yicha (r, φ) nuqtani dekart koordinatalari sistemasi bo'yicha (x, y) nuqtaga akslantirishni ifodalaydi.

(7) sistemaning yakobiani

$$J(u, v) = \begin{vmatrix} \cos \varphi & -r \sin \varphi \\ -r \sin \varphi & r \cos \varphi \end{vmatrix} = r$$

bo'ladi. XOY tekisligidagi yuzaga ega D to'plamni olaylik.

Bu D ning (7) akslantirish yordamida asli (proobrazi) $\Delta \subset \{(r, \varphi) \in R^2 : r \geq 0, 0 \leq \varphi \leq 2\pi\}$ bo'ladi.

Agar O nuqta (koordinata boshi) D ga tegishli bo'lmasa, u holda Δ ni D ga akslantirish o'zaro bir qiymatli bo'lib, sistemaning yakobiani 0 dan farqli bo'ladi.

Agar O nuqta D ga tegishli bo'lsa, u holda (7) akslantirishning o'zaro bir qiymatligi hamda $J(r, \varphi) \neq 0$ shart nol yuzali chiziqlar-dagina bajarilmaydi.

Demak, $f(x, y)$ funksiya $D \cup \partial D$ da uzluksiz bo'lsa u holda

$$\iint_D f(x, y) = \iint_D f(\cos \varphi, r \sin \varphi) r dr d\varphi \quad (8)$$

formula o'rinli bo'ladi.

2- misol. Ushbu $J = \iint_D \frac{1}{(x^2 + y^2)} dx dy$

integral hisoblansin, bunda D – quyidagi $x = 0, y = 0, x + y = a, x + y = b$ ($0 < a < b$) chiziqlar bilan chegaralangan to'plam.

◀ Berilgan integralda o'zgaruvchilarni quyidagicha

$$x = r \cos \varphi, \quad y = r \sin \varphi$$

ko'rinsihda almashtiramiz. Unda $x^2 + y^2 = r^2$ bo'lib, (8) formulaga ko'ra

$$J = \iint_D \frac{1}{r^3} r dr d\varphi = \iint_{\Delta} \frac{1}{r^2} dr d\varphi$$

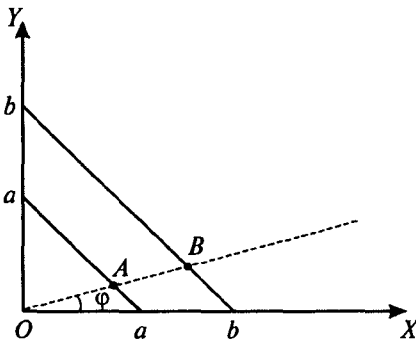

40- chizma.

bo'ladi. Endi Δ ni topamiz. D ning tekislikdagi tasviri 40- chizmada ko'rsatilgan.

Ravshanki, qutb burchagi φ ning o'zgarishi 0 bilan $\frac{\pi}{2}$ orasida bo'-

ladi: $0 \leq \varphi \leq \frac{\pi}{2}$. (r, φ) nuqta D da

bo'lishi uchun r qutb radiusi chiz-mada ko'rsatilgan A nuqta bilan B nuqta orasida bo'lishi kerak.

A nuqtada $x + y = a$ bo'lgani uchun $r \cos \varphi + r \sin \varphi = a$, ya'ni

$$r_A = \frac{a}{\cos \varphi + \sin \varphi},$$

B nuqtada $x + y = b$ bo'lgani uchun $r \cos \varphi + r \sin \varphi = b$, ya'ni

$$r_B = \frac{b}{\cos \varphi + \sin \varphi}$$

bo'lib,

$$r_A \leq r \leq r_B$$

bo'ladi. Demak, $\Delta = \left\{ (r, \varphi) \in R^2 : r_A \leq r \leq r_B, 0 \leq \varphi \leq \frac{\pi}{2} \right\}$.

Natijada
$$\iint_D \frac{1}{r^2} dr d\varphi = \int_0^{\frac{\pi}{2}} \left(\int_{r_A}^{r_B} \frac{1}{r^2} dr \right) d\varphi$$

ga ega bo'lamiz. Integrallarni hisoblab topamiz:

$$\begin{aligned} \int_0^{\frac{\pi}{2}} \left(\int_{r_A}^{r_B} \frac{1}{r^2} dr \right) d\varphi &= \int_0^{\frac{\pi}{2}} \left(-\frac{1}{r} \right)_{r_A}^{r_B} d\varphi = \int_0^{\frac{\pi}{2}} \left(\frac{1}{r_A} - \frac{1}{r_B} \right) d\varphi = \\ &= \int_0^{\frac{\pi}{2}} \left(\frac{\cos \varphi + \sin \varphi}{a} - \frac{\cos \varphi + \sin \varphi}{b} \right) d\varphi = \frac{b-a}{ab} \int_0^{\frac{\pi}{2}} (\cos \varphi + \sin \varphi) d\varphi = 2 \frac{b-a}{ab}. \blacktriangleright \end{aligned}$$

3- misol. Ushbu $J = \iint_D (x + y) dx dy$ integral hisoblansin, bunda D to'plam $x^2 + y^2 = 1$, $x^2 + y^2 = 4$, $y = 0$ (D da $y > 0$) chiziqlar bilan chegaralangan (41- chizma).

(8) formuladan foydalanib topamiz:

$$J = \iint_D (x + y) dx dy = \iint_D (r \cos \varphi + r \sin \varphi) dr d\varphi.$$

Ravshanki,

$$\Delta = \{ (r, \varphi) \in R^2 : 1 \leq r \leq 2, 0 \leq \varphi \leq \pi \}.$$

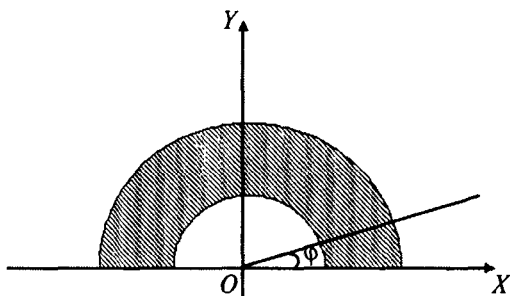

41- chizma.

Natijada
$$J = \iint_D r^2 (\cos \varphi + \sin \varphi) dr d\varphi =$$

$$= \int_0^{\pi} \left(\int_1^2 r^2 (\cos \varphi + \sin \varphi) dr \right) d\varphi = \frac{7}{3} \int_0^{\pi} (\cos \varphi + \sin \varphi) d\varphi = \frac{14}{3}$$

ga ega bo'lamiz. ►

Mashqlar

1. Ushbu $xy = 1$, $xy = 2$, $x - y - 1 = 0$ ($x > 0$, $y > 0$) chiziqlar bilan chegaralangan to'plamni tomonlari koordinatalar o'qiga parallel bo'lgan to'g'ri to'rtburchakka o'tkazuvchi akslantirish topilsin.

2. Ushbu $\iint_D \frac{dx dy}{(x^2 + y^2)^2}$ integral hisoblansin, bunda D quyidagi

$$x^2 + y^2 = 4x, \quad x^2 + y^2 = 8x, \quad y = x, \quad y = 2x$$

chiziqlar bilan chegaralangan.

86- ma'ruza

Ikki karrali integralning ba'zi bir tatbiqlari

1°. **Tekis shaklning yuzi.** Tekislikda yuzaga ega bo'lgan D shakl berilgan bo'lsin. Bu shaklning yuzi

$$\mu D = \iint_D dx dy \tag{1}$$

bo'ladi. Bu tenglikning isboti ikki karrali integral ta'rifidan kelib chiqadi.

Misol. Tekislikning birinchi chora-gida ushbu

$$x^2 + y^2 = 2ax, \quad y^2 = 2ax,$$

$$x = 2a \quad (a > 0)$$

chiziqlar bilan chegaralangan shaklning yuzi topilsin.

◀ Bu shakl 42-chizmada tasvirlangan.

(1) formulaga ko'ra qaralayotgan shaklning yuzi

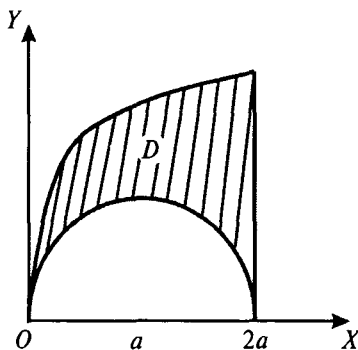

42- chizma.

$$\mu D = \iint_D dx dy$$

bo'lib, bunda

$$D = \{(x, y) \in R^2 : 0 \leq x \leq 2a, \sqrt{2ax - x^2} \leq y \leq \sqrt{2ax}\}.$$

Integralni hisoblab, topamiz:

$$\begin{aligned} \mu D &= \int_0^{2a} \left(\int_{\sqrt{2ax-x^2}}^{\sqrt{2ax}} dy \right) dx = \int_0^{2a} (\sqrt{2ax} - \sqrt{2ax-x^2}) dx = \\ &= \frac{8}{3} a^2 - \frac{\pi}{2} a^2 = \frac{16-3\pi}{6} a^2. \quad \blacktriangleright \end{aligned}$$

2'. Jismning hajmi. 81- ma'ruzada fazodagi jismning hajmi tushunchasi va uning mavjudligi sharti bayon etilgan edi.

Endi jism hajmining ikki karrali integral orqali ifodalanishini ko'rsatamiz.

R^3 fazoda Dekart koordinatalar sistemasi va unga nisbatan joylashgan V jismni qaraylik. Bu jism yuqoridan $z = f(x, y)$ ifodalagan sirt, yon tomondan yasovchilari OZ o'qiga parallel silindrik sirt hamda pastdan XOY tekisligidagi chegaralangan yopiq D to'plam bilan chegaralangan jism bo'lsin. Bunda $f(x, y)$ funksiyani D da uzluksiz deb qaraymiz.

D to'plamning

$$P = \{D_1, D_2, \dots, D_n\}$$

bo'laklashlarini olaylik. U holda

$$m_k = \inf \{f(x, y) : (x, y) \in D_k\},$$

$$M_k = \sup \{f(x, y) : (x, y) \in D_k\}$$

mavjud bo'ladi. Ushbu

$$\mu A = \sum_{k=1}^n m_k \mu D_k, \quad \mu B = \sum_{k=1}^n M_k \mu D_k$$

yig'indilar mos ravishda V jismning ichiga joylashgan A ko'pyoqlikning hajmi va V jismni o'z ichiga olgan B ko'pyoqlikning hajmi bo'lib,

$$\mu A \leq \mu B$$

bo'ladi.

D to'plamni turli bo'laklashlar natijasida hosil bo'lgan $\{\mu A\}$ va $\{\mu B\}$ to'plamlarning chegaralanganligidan $\sup\{\mu A\}$, $\inf\{\mu B\}$ larning mavjud bo'lishi kelib chiqadi.

$f(x, y)$ funksiya yopiq D to'plamda uzluksiz. Demak, u D da tekis uzluksiz. U holda $\forall \varepsilon > 0$ olinganda ham shunday $\delta > 0$ topiladiki, D to'plamning $\lambda_p < \delta$ bo'lgan ixtiyoriy

$$P = \{D_1, D_2, \dots, D_n\}$$

bo'laklash uchun har bir D_k da ($k=1, 2, \dots, n$) funksiyaning tebranishi

$$M_k - m_k < \frac{\varepsilon}{\mu D}$$

tengsizlikni qanoatlantiradi. Shularni e'tiborga olib topamiz:

$$\begin{aligned} \inf \{\mu B\} - \sup \{\mu A\} &\leq \mu B - \mu A = \sum_{k=1}^n M_k \mu D_k - \sum_{k=1}^n m_k \mu D_k = \\ &= \sum_{k=1}^n (M_k - m_k) \mu D_k < \frac{\varepsilon}{\mu D} D_k = \frac{\varepsilon}{\mu D} \mu D = \varepsilon. \end{aligned}$$

Demak, $0 \leq \inf \{\mu B\} - \sup \{\mu A\} \leq \varepsilon$.

Keyingi munosabatdan

$$\inf \{\mu B\} = \sup \{\mu A\}$$

bo'lishi kelib chiqadi. Bu esa V jism hajmga ega bo'lishi va uning hajmi μV ning

$$\mu V = \inf \{\mu B\} = \sup \{\mu A\} \quad (2)$$

ekanligini bildiradi. Ayni paytda,

$$\sup \{\mu B\} = \iint_{\bar{D}} f(x, y) dx dy, \quad \inf \{\mu A\} = \iint_D f(x, y) dx dy$$

va (2) tenglikka ko'ra

$$\iint_{\bar{D}} f(x, y) dx dy = \iint_D f(x, y) dx dy = \iint_D f(x, y) dx dy \quad (3)$$

bo'ladi. (2) va (3) munosabatlardan

$$\mu V = \iint_D f(x, y) dx dy \quad (4)$$

bo'lishi kelib chiqadi.

2- misol. Fazodagi

$$x^2 + y^2 + z - 4 = 0$$

sirt (paraboloid) hamda tekislik bilan chegaralangan jismning hajmi topilsin.

◀ Bu jism 43- chizmada tasvirlangan bo'lib, D to'plam XOY tekislikdagi $x^2 + y^2 \leq 4$ doiradan iborat.

Sirtning tenglamasini $z = 4 - x^2 - y^2$ ko'rinishda yozib, (4) formuladan foydalanib topamiz:

$$\mu V = \iint_D (4 - x^2 - y^2) dx dy, \quad (5)$$

bunda $D = \{(x, y) \in R^2 : x^2 + y^2 \leq 4\}$,

(5) integralda o'zgaruvchilarni quyidagicha

$$\begin{cases} x = r \cos \varphi, \\ y = r \sin \varphi \end{cases}$$

ko'rinishda almashtirib hisoblaymiz:

$$4 - x^2 - y^2 = 4 - r^2, \quad J(r, \varphi) = r, \quad 0 \leq r \leq 2, \quad 0 \leq \varphi \leq 2\pi,$$

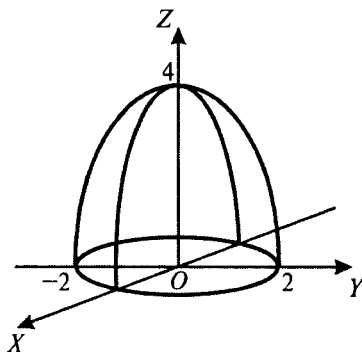

43- chizma.

$$\iint_D (4 - x^2 - y^2) dx dy = \int_0^{2\pi} \left(\int_0^2 (4 - r^2) r dr \right) d\varphi = \int_0^{2\pi} \left(2r^2 - \frac{r^4}{4} \right)_0^2 d\varphi = 8\pi.$$

Demak, jismning hajmi $\mu V = 8\pi$ ga teng.

3°. Sirtning yuzi. Faraz qilaylik, tekislikda yuzaga ega bo'lgan D to'plamda $z = f(x, y)$ funksiya berilgan bo'lib, u shu to'plamda uzluksiz $f'_x(x, y)$, $f'_y(x, y)$ hosilalarga ega bo'lsin. Bu funksiyaning grafigi R^3 fazoda S sirtini ifodalasin (44- chizma).

Bunday sirtning yuzasi ikki karrali integral orqali quyidagicha ifodalanadi:

$$\mu S = \iint_{(D)} \sqrt{1 + f_x'^2(x, y) + f_y'^2(x, y)} dx dy. \quad (6)$$

3- misol. Asosining radiusi r , balandligi h ga teng doiraviy konusning yon sirti topilsin.

◀ Ma'lumki, konus sirt $z = \frac{h}{r} \sqrt{x^2 + y^2}$ tenglama bilan ifodalanadi. (6) formulaga ko'ra konusning yon sirti

$$\mu S = \iint_D \sqrt{1 + (z'_x(x, y))^2 + (z'_y(x, y))^2} dx dy$$

bo'ladi, bunda $D = \{(x, y) \in R^2 : x^2 + y^2 \leq r^2\}$.

Agar
$$z'_x = \frac{h}{r} \frac{x}{\sqrt{x^2 + y^2}}, \quad z'_y = \frac{h}{r} \frac{y}{\sqrt{x^2 + y^2}},$$

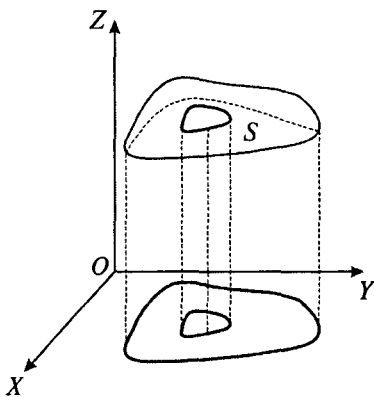

44- chizma.

$$\begin{aligned} & \sqrt{1 + (z'_x(\xi_k, \eta_k))^2 + (z'_y(\xi_k, \eta_k))^2} = \\ & = \sqrt{1 + \frac{h^2}{r^2} \frac{x^2}{x^2 + y^2} + \frac{h^2}{r^2} \frac{y^2}{x^2 + y^2}} = \sqrt{1 + \frac{h^2}{r^2}} \end{aligned}$$

bo'lishini e'tiborga olsak, u holda

$$\begin{aligned} \mu S &= \iint_D \sqrt{1 + \frac{h^2}{r^2}} dx dy = \\ &= \sqrt{1 + \frac{h^2}{r^2}} \iint_D dx dy = \pi r \sqrt{r^2 + h^2} \end{aligned}$$

ekanini topamiz. ▶

4°. Ikki karrali integralning mexanikaga tatbiqlari. Aytaylik, tekislikda massaga ega bo'lgan moddiy D shaklning har bir $(x, y) \in D$ nuqtasidagi zichligi $\rho(x, y)$ bo'lib, u D da uzluksiz bo'lsin. D shaklning massasini topish talab etilsin.

Ravshanki, $\rho(x, y) = C - \text{const}$ bo'lsa, u holda D shaklning massasi

$$m = C\mu D$$

ga teng bo'ladi. Agar $\rho(x, y)$ ixtiyoriy ($k=1, 2, \dots, n$) uzluksiz funksiya bo'lsa, D shaklning massasini topish uchun D ning

$$P = \{D_1, D_2, \dots, D_n\}$$

bo'laklashini va har bir D_k da ($k=1, 2, \dots, n$) ixtiyoriy (ξ_k, ζ_k) nuqtani olamiz: $(\xi_k, \zeta_k) \in D_k$. Har bir D_k da $\rho(x, y)$ ni o'zgarimas va uni $\rho(\xi_k, \eta_k)$ ga teng deyilsa, u holda D_k ning massasi taxminan

$$\rho(\xi_k, \eta_k)\mu D_k$$

ga teng bo'lib, D shaklning massasi esa taxminan

$$\sum_{k=1}^n \rho(\xi_k, \eta_k)\mu D_k \quad (7)$$

ga teng bo'ladi.

P bo'laklashning diametri $\lambda_p \rightarrow 0$ da (7) yig'indining limiti izlanayotgan shaklning massasini ifodalaydi.

Ayni paytda, (7) yig'indi funksiyaning integral yig'indisi va $\rho(x, y)$ funksiya D da uzluksiz bo'lganligi sababli bu yig'indining limiti

$$\iint_D \rho(x, y) dx dy$$

bo'ladi. Demak, D shaklning massasi

$$m = \iint_D \rho(x, y) dx dy \quad (8)$$

tenglik bilan aniqlanar ekan.

4- misol. Tekislikda a radiusli doiraviy plastinka berilgan bo'lib, uning har bir $A(x, y)$ nuqtadagi zichligi shu nuqtadan koordinatalar boshigacha bo'lgan masofaga proporsional. Doiraviy plastinkaning massasi topilsin.

◀ Dekart koordinatalar sistemasining koordinatalar boshiga doiraviy plastinkaning markazini joylashtiramiz. U holda plastinkaning $A(x,y)$ nuqtasidan koordinatalar boshigacha bo'lgan masofa

$$d = \sqrt{x^2 + y^2}$$

bo'lib, plastinka zichligi

$$\rho(x, y) = k\sqrt{x^2 + y^2}$$

bo'ladi, bunda k – proporsionallik koeffitsiyenti.

(8) formulaga ko'ra plastinka massasi

$$m = \iint_D k\sqrt{x^2 + y^2} dx dy$$

bo'ladi, bunda $D = \{(x, y) \in R^2 : x^2 + y^2 \leq r^2\}$.

Ikki karrali integralda

$$\begin{cases} x = r \cos \varphi, \\ y = r \sin \varphi \end{cases}$$

almashtirish bajarib, uni hisoblaymiz:

$$m = \iint_D k\sqrt{x^2 + y^2} dx dy = \int_0^{2\pi} \left(\int_0^a k \cdot r \cdot r dr \right) d\varphi = k \int_0^{2\pi} \left(\frac{r^3}{3} \right)_0^a d\varphi = \frac{2}{3} k\pi a^3. \blacktriangleright$$

Ikki karrali integrallar yordamida statistik momentlar:

$$M_x = \iint_D y\rho(x, y) dx dy, \text{ (OX o'qiga nisbatan),}$$

$$M_y = \iint_D x\rho(x, y) dx dy, \text{ (OY o'qiga nisbatan),}$$

og'irlik markazining koordinatalari:

$$x_0 = \frac{1}{\iint_D dx dy} \iint_D x dx dy, \quad y_0 = \frac{1}{\iint_D dx dy} \iint_D y dx dy,$$

inersiya momentlari:

$$J_x = \iint_D y^2 \rho(x, y) dx dy, \text{ (OX o'qiga nisbatan),}$$

$$J_y = \iint_D x^2 p(x, y) dx dy, \text{ (OY o'qiga nisbatan).}$$

$$J_0 = \iint_D (x^2 + y^2) p(x, y) dx dy \text{ (koordinatalar boshiga nisbatan)}$$

topiladi.

Mashqlar

1. Tekislikda ushbu

$$x = \frac{y^2 + a^2}{2a}, \quad x = \frac{y^2 + b^2}{2b}, \quad (0 < a < b)$$

parabolalar bilan chegaralangan shaklning yuzi topilsin.

2. Fazoda quyidagi

$$x^2 + y^2 = 4x, \quad z = x, \quad z = 2x$$

sirtlar bilan chegaralangan jismning hajmi topilsin.

87- ma'ruza

Uch karrali integrallar

Matematik analiz kursi davomida $f(x)$ funksiyaning $[a, b] \subset R$ segment bo'yicha aniq integrali, $f(x, y)$ funksiyaning $D \subset R^2$ to'plam bo'yicha ikki karrali integrali tushunchalari kiritilib, ular batafsil o'rganildi.

Xuddi shunga o'xshash bu tushuncha uch o'zgaruvchili $f(x, y, z)$ funksiya uchun ham kiritiladi. Unda, avvalgi hollarda keltirilgan ma'lumotlar va ularni isbotlashda yuritilgan mulohozalar qaytariladi.

Shuni e'tiborga olib, uch karrali integral haqida tushuncha va tasdiqlarni keltirish bilan chegaralanamiz.

1⁰. Uch karrali integral tushunchasi. Faraz qilaylik, R^3 fazoda chegaralangan hamda hajmga ega bo'lgan V jism (to'plam) da $f(x, y, z)$ funksiya aniqlangan va chegaralangan bo'lsin.

$$m \leq f(x, y, z) \leq M, \quad ((x, y, z) \in V).$$

V to'plamning biror

$$P = \{V_1, V_2, \dots, V_n\}$$

bo'laklashini va har bir V_k da ixtiyoriy $(\xi_k, \eta_k, \zeta_k) \in V_k$ nuqtani ($k = 1, 2, \dots, n$) olib, ushbu

$$\sigma = \sum_{k=1}^n f(\xi_k, \eta_k, \zeta_k) \mu V_k$$

yig'indini tuzamiz. U $f(x, y, z)$ funksiyaning integral yig'indisi deyiladi.

1- ta'rif. Agar $\forall \varepsilon > 0$ son olinganda ham shunday $\delta > 0$ son topilsaki, V to'plamning diametri $\lambda_p > \delta$ bo'lgan har qanday P bo'laklash hamda har bir V_k da olingan ixtiyoriy (ξ_k, η_k, ζ_k) lar uchun

$$|\sigma - J| < \varepsilon$$

tengsizlik bajarilsa, J son σ yig'indining $\lambda_p > \delta$ dagi limiti deyiladi va quyidagicha belgilanadi:

$$\lim_{\lambda_p \rightarrow 0} \sigma = J.$$

2- ta'rif. Agar $\lambda_p > \delta$ da $f(x, y, z)$ funksiyaning integral yig'indisi chekli limitga ega bo'lsa, $f(x, y, z)$ funksiya V to'plamda integrallanuvchi, J songa esa $f(x, y, z)$ funksiyaning V to'plam bo'yicha uch karrali integrali deyiladi va quyidagicha

$$\iiint_V f(x, y, z) dx dy dz$$

ko'rinishda belgilanadi. Demak,

$$\iiint_V f(x, y, z) dx dy dz = \lim_{\lambda_p \rightarrow 0} \sum_{k=1}^n f(\xi_k, \eta_k, \zeta_k) \mu V_k.$$

$f(x, y, z)$ funksiya V da chegaralanganligi uchun

$$m_k = \inf\{f(x, y, z) : (x, y, z) \in V_k\},$$

$$M_k = \sup\{f(x, y, z) : (x, y, z) \in V_k\}$$

mavjud. Ushbu $s = \sum_{k=1}^n m_k \mu V_k$, $S = \sum_{k=1}^n M_k \mu V_k$

yig'indilar mos ravishda Darbuning quyi hamda yuqori yig'indilari deyiladi.

$$\text{Ravshanki, } s = s_p(f), \quad S = S_p(f)$$

bo'lib, $\{s = s_p(f)\}$, $\{S = S_p(f)\}$ to'plamlar chegaralangan bo'ladi.

3- ta'rif. $\{s_p(f)\}$ to'plamning aniq yuqori chegarasi $f(x,y,z)$ funksiyaning quyi uch karrali integrali deyiladi va

$$\underline{J} = \iiint_V f(x, y, z) dx dy dz$$

kabi belgilanadi.

4- ta'rif. $\{S_p(f)\}$ to'plamning aniq quyi chegarasi $f(x,y,z)$ funksiyaning yuqori uch karrali integrali deyiladi va

$$\bar{J} = \iiint_V f(x, y, z) dx dy dz$$

kabi belgilanadi.

5- ta'rif. Agar $\underline{J} = \bar{J}$ bo'lsa, $f(x,y,z)$ funksiya V to'plamda integrallanuvchi, ularning umumiy qiymati

$$J = \underline{J} = \bar{J}$$

$f(x,y,z)$ funksiyaning V to'plam bo'yicha uch karrali integrali deyiladi.

2°. Uch karrali integralning mavjudligi. Quyidagi teorema uch karrali integralning mavjudligini ifodalaydi.

1- teorema. $f(x,y,z)$ funksiyaning V to'plamda integrallanuvchi bo'lishi uchun $\forall \varepsilon > 0$ son olinganda ham shunday $\delta > 0$ son topilib, V to'plamning diametri $\lambda_p > \delta$ bo'lgan har qanday P bo'laklashiga nisbatan Darbu yig'indilari ushbu

$$S_p(f) - s_p(f) < \varepsilon \quad (1)$$

tengsizlikni qanoatlantirishi zarur va yetarli.

Agar $f(x,y,z)$ funksiyaning V_k dagi tebranishini ω_k desak, u holda

$$S_p(f) - s_p(f) = \sum_{k=1}^n (M_k - m_k) \mu V_k = \sum_{k=1}^n \omega_k \mu V_k$$

bo'lib, (1) shart ushbu

$$\sum_{k=1}^n \omega_k \mu V_k < \varepsilon$$

ko'rinishni oladi. Bu holda

$$\lim_{\lambda_p \rightarrow 0} \sum_{k=1}^n \omega_k \mu V_k = 0$$

deyish mumkin.

3°. Integrallanuvchi funksiyalar sinfi. Uch o'zgaruvchili $f(x,y,z)$ funksiyalar ma'lum shartlarni qanoatlantirganda ularning integrallanuvchi bo'lishini ifodalaydigan teoremlarni keltiramiz.

2- teorema. Agar $f(x,y,z)$ funksiya chegaralangan yopiq V to'plamda uzluksiz bo'lsa, u shu to'plamda integrallanuvchi bo'ladi.

Aytaylik, R^3 fazoda S sirt berilgan bo'lsin.

6- ta'rif. Agar R^3 da shunday V_0 ko'pyoqlik topilsaki,

$$1) S \subset V_0,$$

2) $\forall \varepsilon > 0$ uchun $\mu V_0 < \varepsilon$ bo'lsa, S nol hajmli sirt deyiladi.

3- teorema. Agar $f(x,y,z)$ funksiya chegaralangan yopiq V to'plamdagi chekli sonda nol hajmli sirtlarda uzilishga ega, qolgan barcha nuqtalarda uzluksiz bo'lsa, $f(x,y,z)$ funksiya V to'plamda integrallanuvchi bo'ladi.

4°. Uch karrali integralning xossalari. Uch karrali integrallar ham ikki karrali integralning xossalari kabi xossalarga ega.

1) $f(x,y,z)$ funksiya V da ($V \subset R^3$) integrallanuvchi bo'lsin. Agar V to'plam nol hajmli S sirt bilan umumiy ichki nuqtaga ega bo'lmagan bog'lamli V_1 va V_2 to'plamlarga ajralgan bo'lsa, $f(x,y,z)$ funksiya har bir V_1 va V_2 to'plamlarda integrallanuvchi va quyidagicha bo'ladi:

$$\iiint_V f(x,y,z) dx dy dz = \iiint_{V_1} f(x,y,z) dx dy dz + \iiint_{V_2} f(x,y,z) dx dy dz.$$

2) Agar $f(x,y,z)$ funksiya V to'plamda integrallanuvchi bo'lsa, $c \cdot f(x,y,z)$ funksiya ($c = \text{const}$) ham V to'plamda integrallanuvchi va

$$\iiint_V cf(x,y,z) dx dy dz = c \iiint_V f(x,y,z) dx dy dz$$

bo'ladi.

3) Agar $f(x,y,z)$ va $g(x,y,z)$ funksiyalar V da integrallanuvchi bo'lsa, $f(x,y,z) \pm g(x,y,z)$, $f(x,y,z) \cdot g(x,y,z)$ funksiyalar integrallanuvchi va

$$\begin{aligned} & \iiint_V [f(x,y,z) \pm g(x,y,z)] dx dy dz = \\ & = \iiint_V f(x,y,z) dx dy dz \pm \iiint_V g(x,y,z) dx dy dz \end{aligned}$$

bo'ladi.

4) Agar $f(x,y,z)$ funksiya V to'plamda integrallanuvchi bo'lib, $\forall(x,y,z) \in V$ da $f(x,y,z) \geq 0$ bo'lsa,

$$\iiint_V f(x,y,z) dx dy dz \geq 0$$

bo'ladi.

5) Agar $f(x,y,z)$ funksiya V to'plamda integrallanuvchi bo'lsa, u holda $|f(x,y,z)|$ funksiya ham V da integrallanuvchi va

$$\left| \iiint_V f(x,y,z) dx dy dz \right| \leq \iiint_V |f(x,y,z)| dx dy dz$$

bo'ladi.

6) Agar $f(x,y,z)$ funksiya V to'plamda integrallanuvchi bo'lsa, u holda shunday α son ($m \leq \alpha \leq M$) topiladiki, bunda

$$\iiint_V f(x,y,z) dx dy dz = \alpha \mu V \quad (\forall(x,y,z) \in V : m \leq f(x,y,z) \leq M)$$

bo'ladi (o'rta qiymat haqidagi teorema).

5°. Uch karrali integrallarni hisoblash. Uch karrali integrallarni hisoblash formulalari integrallash to'plamining ko'rinishiga qarab turlicha bo'ladi.

a) Aytaylik, $f(x,y,z)$ funksiya R^3 fazodagi to'plam

$$V = \{(x,y,z) \in R^3 : a \leq x \leq b, c \leq y \leq d, p \leq z \leq q\}$$

da (parallelepipedda) uzluksiz bo'lsin. U holda quyidagicha bo'ladi:

$$\iiint_V f(x,y,z) dx dy dz = \int_a^b \left[\int_c^d \left(\int_p^q f(x,y,z) dz \right) dy \right] dx. \quad (2)$$

b) Aytaylik, R^3 fazodagi V to'plam pastdan $z = \psi_1(x,y)$, yuqoridan $z = \psi_2(x,y)$ sirt (bunda $D \subset R^2$ to'plam V jismning XOY tekislikdagi proyeksiyasi) bilan chegaralangan bo'lsin. Agar bu V da $f(x,y,z)$ uzluksiz, $\psi_1(x,y)$ va $\psi_2(x,y)$ funksiyalar D da uzluksiz bo'lsa, u holda quyidagicha bo'ladi.:

$$\iiint_V f(x,y,z) dx dy dz = \iint_D \left(\int_{\psi_1(x,y)}^{\psi_2(x,y)} f(x,y,z) dz \right) dx dy. \quad (3)$$

d) Aytaylik, b) holdagi D to'plam quyidagicha

$$D = \{(x, y) \in R^2 : a \leq x \leq b, \varphi_1(x) \leq y \leq \varphi_2(x)\}$$

bo'lib, φ_1 va φ_2 funksiyalar $[a, b]$ da uzluksiz bo'lsin. U holda

$$\iiint_V f(x, y, z) dx dy dz = \int_a^b \left[\int_{\varphi_1(x)}^{\varphi_2(x)} \left(\int_{\psi_1(x, y)}^{\psi_2(x, y)} f(x, y, z) dz \right) dy \right] dx$$

bo'ladi.

1- misol. Ushbu $J = \iiint_V (x + y + z) dx dy dz$ integral hisoblansin,

bunda $V = \{(x, y, z) \in R^3 : 0 \leq x \leq 1, 0 \leq y \leq 3, 0 \leq z \leq 2\}$.

◀ Yuqoridagi (2) formuladan foydalanib berilgan integralni hisoblaymiz:

$$\begin{aligned} & \int_0^1 \left[\int_0^3 \left(\int_0^2 (x + y + z) dz \right) dy \right] dx = \int_0^1 \left[\int_0^3 \left(xz + yz + \frac{z^2}{2} \right)_{z=0}^{z=2} dy \right] dx = \\ & = \int_0^1 \left[\int_0^3 2(x + y + 1) dy \right] dx = \int_0^1 2 \left(xy + \frac{y^2}{2} + y \right)_{y=0}^{y=3} dx = \int_0^1 (6x + 15) dx = 18. \blacktriangleright \end{aligned}$$

2- misol. Ushbu $\iiint_{(V)} z^2 dx dy dz$ integral hisoblansin, bunda V –

konus ($z = \sqrt{x^2 + y^2}$) va $z = h$ tekislik bilan chegaralangan to'plam.

◀ V ning XOY tekislikdagi proyeksiyasi

$$D = \{(x, y) \in R^2 : x^2 + y^2 \leq h^2\}$$

bo'ladi. (3) formuladan foydalanib topamiz:

$$J = \iint_D \left(\int_{\sqrt{x^2+y^2}}^h z^2 dz \right) dx dy = \iint_D \left[\frac{h^3}{3} - \frac{1}{3} (x^2 + y^2)^{\frac{3}{2}} \right] dx dy.$$

Keyingi integralda

$$\begin{cases} x = r \cos \varphi, \\ y = r \sin \varphi \end{cases}$$

almashtirish bajarib, uni hisoblaymiz:

$$J = \int_0^{2\pi} \left[\int_0^h \left(\frac{h^3}{3} - \frac{1}{3} r^3 \right) r dr \right] d\varphi = \frac{1}{5} \pi h^5 . \blacktriangleright$$

6°. Uch karrali integrallarda o'zgaruvchilarni almashtirish.
Aytaylik, $f(x,y,z)$ funksiya $V \subset R^3$ to'plamda berilgan va uzluksiz bo'lsin. Ushbu

$$\begin{cases} x = \varphi(u, v, w), \\ y = \psi(u, v, w), \\ z = \chi(u, v, w) \end{cases}$$

sistema $\Delta \subset R^3$ to'plamni V to'plamga akslantirish bo'lib, bu akslantirish 85- ma'ruzada keltirilgan 1– 3- shartlarni bajarsin. U holda

$$\begin{aligned} & \iiint_V f(x, y, z) dz dy dx = \\ & = \iiint_{\Delta} f(\varphi(u, v, w), \psi(u, v, w), \chi(u, v, w)) |J| du dv dw \end{aligned}$$

bo'ladi, bunda

$$J = \begin{vmatrix} \frac{dx}{du} & \frac{dx}{dv} & \frac{dx}{dw} \\ \frac{dy}{du} & \frac{dy}{dv} & \frac{dy}{dw} \\ \frac{dz}{du} & \frac{dz}{dv} & \frac{dz}{dw} \end{vmatrix}$$

bo'ladi.

Ko'p hollarda dekart koordinatalaridan silindrik hamda sferik koordinatalarga o'tish bilan uch karrali integrallar hisoblanadi.

a) Dekart koordinatalari x, y, z dan silindrik koordinatalar ρ, φ, z ga o'tish

$$x = \rho \cos \varphi, \quad y = \rho \sin \varphi, \quad z = z$$

($0 \leq \rho \leq +\infty, 0 \leq \varphi \leq 2\pi, -\infty < z < +\infty$) formulalar yordamida amalga oshiriladi (45- chizma).

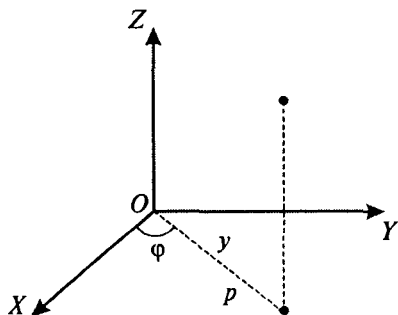

45- chizma.

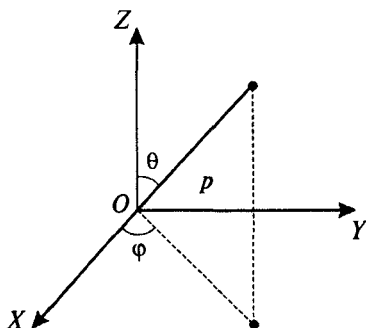

46- chizma.

Bu almashtirishning yakobiani $J = p$ bo'lib,

$$\iiint_V f(x, y, z) dx dy dz = \iiint_{\Delta} f(p \cos \varphi, p \sin \varphi, z) p dp d\varphi dz$$

ga ega bo'lamiz.

b) Dekart koordinatalari x, y, z dan sferik koordinatalar p, φ, θ ga o'tish

$$x = p \sin \theta \cdot \cos \varphi, \quad y = p \sin \theta \cdot \sin \varphi, \quad z = p \cos \theta$$

($0 \leq p \leq +\infty, 0 \leq \varphi \leq 2\pi, 0 \leq \theta \leq \pi$) formulalar yordamida amalga oshiriladi (46- chizma).

Almashtirish yakobiani $J = p^2 \sin \theta$ bo'lib,

$$\begin{aligned} \iiint_V f(x, y, z) dx dy dz &= \\ &= \iiint_V f(p \sin \theta \cos \varphi, p \sin \theta \sin \varphi, p \cos \theta) p^2 \sin \theta dp d\varphi d\theta \end{aligned}$$

bo'ladi.

3- misol. Ushbu $\iiint_V z dz dy dz$

integral hisoblansin. Bunda quyidagi

$$\frac{x^2 + y^2}{r^2} = \frac{z^2}{h^2}, \quad (h > 0)$$

konusning yuqori qismi va $z = h$ tekislik bilan chegaralangan to'plam.

◀ Berilgan integralda o'zgaruvchini quyidagicha

$$x = p \cos \varphi, \quad y = p \sin \varphi, \quad z = z$$

ko'rinishda almashtirib topamiz:

$$\frac{x^2 + y^2}{r^2} = \frac{z^2}{h^2} \Rightarrow \frac{p^2}{r^2} = \frac{z^2}{h^2} \Rightarrow z = \pm \frac{h}{r} p,$$

$$(0 \leq p \leq r, \quad 0 \leq \varphi \leq 2\pi, \quad 0 \leq \theta \leq \pi).$$

Natijada

$$\iiint_V z dx dy dz = \int_0^r \left[\int_0^{2\pi} \left(\int_{\frac{h}{r}p}^h p z dz \right) d\varphi \right] dp$$

bo'ladi. Keyingi integralni hisoblaymiz:

$$\begin{aligned} \int_0^r \left[\int_0^{2\pi} \left(p \frac{z^2}{2} \right)_{z=\frac{h}{r}p}^{z=h} d\varphi \right] dp &= \int_0^r \left[\int_0^{2\pi} \left(\frac{h^2}{2} - \frac{h^2}{2r^2} p^2 \right) p d\varphi \right] dp = \\ &= \frac{\pi h^2 r^2}{r^2} \int_0^r (r^2 - p^2) p dp = \pi h^2 \left(\frac{p^2}{2} \right)_0^r = \frac{\pi h^2 r^2}{4}. \end{aligned}$$

Demak, $J = \frac{\pi h^2 r^2}{4}$. ▶

4- misol. Ushbu $J = \iiint_V (x^2 + y^2 + z^2) dx dy dz$

integral hisoblansinki, bunda V to'plam

$$x^2 + y^2 + z^2 \leq r^2$$

shardan iborat.

◀ Bu intervalda

$$x = p \sin \theta \cdot \cos \varphi, \quad y = p \sin \theta \cdot \sin \varphi, \quad z = p \cos \theta$$

almashtirish bajaramiz. U holda

$$x^2 + y^2 + z^2 = p^2, \quad J = p^2 \sin \theta$$

bo'lib,

$$0 \leq p \leq r, \quad 0 \leq \varphi \leq 2\pi, \quad 0 \leq \theta \leq \pi$$

bo'ladi. Natijada berilgan integral

$$J = \iiint_V (x^2 + y^2 + z^2) dx dy dz = \int_0^r \left[\int_0^\pi \left(\int_0^{2\pi} p^2 p^2 \sin \theta d\varphi \right) d\theta \right] dp$$

ko'rinishga keladi. Keyingi integralni hisoblaymiz:

$$\int_0^r \left[\int_0^\pi \left(\int_0^{2\pi} p^4 \sin \theta d\varphi \right) d\theta \right] dp = \int_0^r \left[\int_0^\pi (p^4 \sin \theta \cdot 2\pi) d\theta \right] dp = 4\pi \int_0^r p^4 dp = \frac{4\pi r^5}{5}.$$

Demak, $J = \frac{4\pi r^5}{5}$. ►

7°. Uch karrali integrallarning ba'zi tatbiqlari. Uch karrali integral yordamida R^3 fazodagi jismlarning hajmini, massali jismning massasini, og'irlik markazini, inersiya momentlarini topish mumkin.

Mashqlar

1. Ushbu

$$\iiint_V \sqrt{x^2 + y^2} dx dy dz$$

integral hisoblansin, bunda V – fazoda quyidagi

$$x^2 + y^2 = z^2, \quad z = 1$$

sirtlar bilan chegaralangan jism (to'plam).

2. Sferik koordinatalarga o'tib, ushbu

$$\iiint_V \sqrt{x^2 + y^2 + z^2} dx dy dz$$

integral hisoblansin, bunda V – fazoda

$$x^2 + y^2 = z^2 = z$$

sirt bilan chegaralangan jism (to'plam).

17- B O B

EGRI CHIZIQLI INTEGRALLAR

88- ma'ruza

Egri chiziqlar va ularning uzunliklari haqida

1°. Egri chiziq tushunchasi. Oliy matematikaning dastlabki qismini o'rganish mobaynida o'quvchi egri chiziq va uning tenglamalari, egri chiziqning uzunligi kabi ma'lumotlar, shuningdek, ba'zi egri chiziqning tasvirlari bilan tanishgan. Egri chizikli integrallar nazariyasida (shuningdek, keyinchalik o'rganiladigan kompleks analiz kursida) egri chiziqning muhimligini e'tiborga olib, ular haqida ba'zi ma'lumotlarni keltirish lozim topildi. Hozirgi zamon matematikasida egri chiziq turlicha ta'riflangan bo'lib, ular orasida Jordan tomonidan keltirilgan ta'rif birmuncha tabiiyroq hisoblanadi. U egri chiziqni nuqtaning uzluksiz harakati natijasida qoldirgan izi sifatida qaragan.

$x(t)$, $y(t)$ funksiyalar $[\alpha, \beta]$ segmentda aniqlangan va uzluksiz bo'lsin. Bu funksiyalardan tuzilgan ushbu

$$\begin{cases} x = x(t), \\ y = y(t) \end{cases} \quad (\alpha \leq t \leq \beta) \quad (1)$$

sistemani qaraylik. Tekislikda dekart koordinatalar sistemasini olib, x va y larni shu tekislikdagi biror M nuqtaning koordinatalari sifatida qaraymiz: $M = M(x, y)$. Ravshanki, M nuqta $[\alpha, \beta]$ dan olingan t ga bog'liq. Ayni paytda, M nuqta argument t ning (1) akslantirishdagi aksi (obrazi), t ning o'zi bu akslantirishdagi M nuqtaning asli (proobrazi) bo'ladi. Shunday qilib, (1) akslantirish yordamida $[\alpha, \beta]$ segmentning aksi tekislikda ushbu

$$\Gamma = \{(x, y) : x = x(t), y = y(t), t \in [\alpha, \beta]\}$$

to'plamni hosil qiladi. Bu Γ to'plamga *tekislikdagi egri chiziq* deyiladi. Demak, egri chiziq $[\alpha, \beta]$ da uzluksiz bo'lgan 2 ta $x(t)$, $y(t)$ funksiyalar yordamida ta'riflanar ekan. Odatda, egri chiziqning bunday berilishi uning parametrik ko'rinishda berilishi deyiladi. Bunda t – parametr. Masalan:

$$\begin{cases} x = r \cos t, \\ y = r \sin t \end{cases} \quad (0 \leq t \leq 2\pi, r > 0) \quad (2)$$

sistema tekislikda markazi koordinatalar boshida, radiusi r ga teng bo'lgan aylananing ifodalaydi. Demak, (2) – aylananing parametrik tenglamasi.

Ba'zi hollarda egri chiziqning ta'rifini ifodalaydigan Γ to'plam murakkab bo'lib, hatto u biz tasavvur etadigan egri chiziqqa butunlay o'xshamay qolishi mumkin. Masalan, Peano tomonidan $[0,1]$ segmentda uzluksiz bo'lgan shunday $x(t)$, $y(t)$ funksiyalar tuzilgan: Γ to'plam uchlari $(0,0)$, $(1,0)$, $(1,1)$, $(0,1)$, nuqtalarda bo'lgan kvadratdan iborat bo'ladi. Boshqacha qilib aytganda, «Egri chiziq» kvadratning har bir nuqtasidan o'tadi. Bu «Egri chiziq» shu bilan xarakterlanadiki, bunda parametrning cheksiz ko'p turli qiymatlarida $x(t)$ va $y(t)$ funksiyalar bir xil qiymatni qabul qiladi.

$$\text{Aytaylik,} \quad \begin{cases} x = x(t), \\ y = y(t) \end{cases} \quad (\alpha \leq t \leq \beta) \quad (3)$$

tenglamalar sistemasi biror egri chiziqni aniqlasin, bunda $x(t)$, $y(t)$ funksiyalar $[\alpha, \beta]$ da uzluksiz. Agar $t_1, t_2 \in [\alpha, \beta]$ da $t_1 \neq t_2$ bo'lganda

$$x(t_1) = x(t_2), \quad y(t_1) = y(t_2)$$

bo'lsa, u holda egri chiziqning $(x(t_1), y(t_1))$ va $(x(t_2), y(t_2))$ nuqtalari uning karrali nuqtalari deyiladi (bu nuqtada egri chiziq o'zini o'zi kesib o'tadi). Karrali nuqtalarga ega bo'lmagan egri chiziq *sodda Jordan egri chizig'i* deyiladi. Bu holda t parametrning turli t_1, t_2 ($t_1 \neq t_2$) qiymatlariga mos keluvchi egri chiziqning $(x(t_1), y(t_1))$, $(x(t_2), y(t_2))$ nuqtalari turlicha bo'ladi. Masalan, $[a, b]$ segmentda uzluksiz bo'lgan $y = f(x)$ funksiya grafigi sodda Jordan egri chizig'i bo'ladi. Haqiqatan ham,

$$\begin{cases} x = t, \\ y = f(t), \end{cases} \quad (y = f(x), \quad a \leq x \leq b)$$

deyilsa, u holda turli t_1, t_2 ($t_1 \neq t_2$) uchun $x_1 \neq x_2$ ($x_1 = t_1, x_2 = t_2$) bo'lishi ravshan. Agar (3) sistema bilan aniqlanadigan egri chiziqda t parametrning turli t_1, t_2 ($t_1 \neq t_2$) qiymatlariga mos keluvchi egri

chiziqning $(x(t_1), y(t_1)), (x(t_2), y(t_2))$ nuqtalari ham turlicha bo'lib,

$$x(\alpha) = x(\beta), \quad y(\alpha) = y(\beta)$$

bo'lsa, egri chiziq *sodda yopiq egri chiziq* deyiladi. Masalan, ushbu

$$\begin{cases} x = a \cos t, \\ y = b \sin t \end{cases} \quad (0 \leq t \leq 2\pi, \quad a > 0, \quad b > 0)$$

sistema bilan aniqlangan egri chiziq (ellips) sodda yopiq egri chiziq bo'ladi.

Biror sodda egri chiziq ushbu

$$\begin{cases} x = x(t), \\ y = y(t) \end{cases} \quad (\alpha \leq t \leq \beta)$$

tenglamalar sistemasi bilan aniqlanadigan bo'lsin. $(x(\alpha), y(\alpha)) = A$, $(x(\beta), y(\beta)) = B$ nuqtalar bu egri chiziqning mos ravishda boshi va oxirgi nuqtalari deyiladi. Bu holda egri chiziqni AB yoy deb ham yuritiladi.

Parametr $t \in [\alpha, \beta]$ ning t_1, t_2 ($t_1 \neq t_2$) qiymatlari uchun $t_1 < t_2$ bo'lganda egri chiziqning $(x(t_2), y(t_2))$ nuqtasi $(x(t_1), y(t_1))$ nuqtadan keyin kelishi bilan AB yoyda yo'nalish o'rnatiladi. Bunday yo'nalish A dan B ga qarab bo'ladi. Agar (3) sistemadagi

$$x = x(t), \quad y = y(t)$$

funksiyalar $[\alpha, \beta]$ da uzluksiz $x'(t)$, $y'(t)$ hosilalarga ega bo'lib, $x'^2(t) + y'^2(t) > 0$ bo'lsa, (3) sistema aniqlagan egri chiziq *silliqlik egri chiziq* deyiladi. Agar AB egri chiziq chekli sondagi sillikli egri chiziq-lardan tashkil topgan bo'lsa, uni *bo'lakli sillikli egri chiziq* deyiladi. Silliqlik egri chiziq har bir nuqtasi urinmaga (chetki nuqtalarda bir tomonli urinmalarga) ega bo'ladi. Bo'lakli sillikli egri chiziq-lar esa chekli sondagi nuqtalarda bir tomonli urinmalarga ega bo'lishi mumkin. Masalan

$$\begin{cases} x = a \cos t, \\ y = b \sin t \end{cases} \quad (0 \leq t \leq 2\pi)$$

ellips — sillikli egri chiziq, siniqlik chiziq esa bo'lakli sillikli egri chiziq bo'ladi.

2°. Egri chiziqning mavjudligi va uning uzunligi. Faraz qilaylik, AB egri chiziq

$$\begin{cases} x = x(t), \\ y = y(t) \end{cases} \quad (\alpha \leq t \leq \beta)$$

tenglamalar sistemasi bilan aniqlangan bo'lsin, bunda $A = (x(\alpha), y(\alpha))$, $B = (x(\beta), y(\beta))$, $[\alpha, \beta]$ segmentning ixtiyoriy bo'laklanishi

$$P = \{t_0, t_1, \dots, t_{n-1}, t_n\}, \quad (t_0 = \alpha, t_n = \beta)$$

ni olamiz. P bo'laklashning bo'luvchi t_k ($k = 0, 1, 2, \dots, n$) nuqtalari AB egri chiziqda

$$A_k = (x(t_k), y(t_k)); \quad (k = 0, 1, 2, 3, \dots, n, A_0 = A, A_n = B)$$

nuqtalarni hosil qiladi. Bu nuqtalarni bir-biri bilan to'g'ri chiziq kesmalari yordamida birlashtirib, AB egri chiziqqa chizilgan siniq chiziqni topamiz. Ravshanki, siniq chiziq uzunlikka ega (odatda, siniq chiziq uzunligi uning perimetri deyiladi). Uni L bilan belgilaylik. Siniq chiziq perimetri L $[\alpha, \beta]$ ning bo'laklanishi P ga bog'liq bo'ladi: $L = L(P)$. $[\alpha, \beta]$ segmentning barcha bo'laklashlari to'plami $P = \{P\}$ ning har bir bo'laklashiga nisbatan egri chiziqqa siniq chiziq chiziladi. Bunday siniq chiziqlarning perimetrlari $\{L(P)\}$ to'plamni hosil qiladi.

I-ta'rif. Agar $\{L(P)\}$ to'plam chegaralangan bo'lsa, AB egri chiziq uzunlikka ega deyiladi. Agar $\{L(P)\}$ to'plam chegaralanmagan bo'lsa, AB egri chiziq uzunlikka ega emas deyiladi.

Endi egri chiziqning uzunlikka ega bo'lishini ifodalaydigan teoremlarni isbotsiz keltiramiz.

Aytaylik, AB egri chiziq ushbu

$$\begin{cases} x = x(t), \\ y = y(t) \end{cases} \quad (\alpha \leq t \leq \beta)$$

tenglamalar sistemasi bilan aniqlangan bo'lsin. $[\alpha, \beta]$ segmentning ixtiyoriy

$$P = \{t_0, t_1, \dots, t_{n-1}, t_n\}, \quad (t_0 = \alpha, t_n = \beta)$$

bo'laklashini olib, quyidagi

$$S_1 = \sum_{k=0}^{n-1} |x(t_{k+1}) - x(t_k)|, \quad S_2 = \sum_{k=0}^{n-1} |y(t_{k+1}) - y(t_k)|$$

yig'indilarni tuzamiz. Ravshanki, bu yig'indilar P bo'laklashga bog'liq bo'ladi:

$$S_1 = S_1(P), \quad S_2 = S_2(P).$$

1- teorema. \widehat{AB} egri chiziq uzunlikka ega bo'lishi uchun $[\alpha, \beta]$ segmentning barcha turli bo'laklashlari bo'yicha tuzilgan $\{S_1(P), S_2(P)\}$ to'plamlarning chegaralangan bo'lishi zarur va yetarli.

Xususan, egri chiziq

$$y = f(x), \quad (a \leq x \leq b) \quad (4)$$

tenglama bilan aniqlangan bo'lib, $f(x)$ funksiya $[a, b]$ segmentda uzluksiz bo'lsin. $[a, b]$ segmentning ixtiyoriy

$$P = \{x_0, x_1, \dots, x_{n-1}, x_n\}, \quad (x_0 = a, x_n = b)$$

bo'laklashini olib, unga nisbatan ushbu

$$S(P) = \sum_{k=0}^{n-1} |f(x_{k+1}) - f(x_k)|$$

yig'indini hosil qilamiz.

2- teorema. (4) egri chiziq uzunlikka ega bo'lishi uchun $[a, b]$ segmentning barcha turli bo'laklashlari bo'yicha tuzilgan

$$S(P) = \sum_{k=0}^{n-1} |f(x_{k+1}) - f(x_k)|$$

to'plamning chegaralangan bo'lishi zarur va yetarli.

1- misol. 1. Ushbu

$$f(x) = \begin{cases} x \cos \frac{\pi}{x}, & \text{agar } 0 < x \leq 1, \\ 0, & \text{agar } x = 0 \end{cases}$$

tenglamalar bilan aniqlangan egri chiziq uzunlikka ega emasligi isbotlansin.

◀ Bu funksiya $[0, 1]$ segmentda uzluksiz bo'ladi. segmentning

$$P = \{x_0, x_1, \dots, x_{n-1}, x_n\}$$

bo'laklashini olaylik, bunda

$$x_0 = 0, \quad x_1 = \frac{1}{n}, \quad x_2 = \frac{1}{n-1}, \quad \dots, \quad x_{n-1} = \frac{1}{2}, \quad x_n = 1$$

bo'lsin. Ravshanki,

$$k = 0 \text{ da } f(x_0) = f(0) = 0,$$

$$k \neq 0 \text{ da } f(x_k) = x_k \cos \frac{\pi}{x_k} = \frac{1}{n-k+1} \cos(n-k+1)\pi = \frac{(-1)^{n-k+1}}{n-k+1}$$

bo'lib,

$$|f(x_{k+1}) - f(x_k)| = \frac{1}{n-k} + \frac{1}{n-k+1}$$

bo'ladi. Natijada

$$\begin{aligned} S(P) &= \sum |f(x_{k+1}) - f(x_k)| = |f(x_1)| + |f(x_2) - f(x_1)| + \dots + |f(x_n) - f(x_{n-1})| = \\ &= \frac{1}{n} + \frac{1}{n-1} + \frac{1}{n} + \dots + \frac{1}{2} + 1 \end{aligned}$$

bo'lib, bundan $S(P) > 1 + \frac{1}{2} + \frac{1}{3} + \dots + \frac{1}{n}$ bo'lishligi kelib chiqadi.

Keyingi tengsizlikdan esa $S(P)$ ning chegaralanmaganligini topamiz. ►

2- misol. Ushbu

$$f(x) = \begin{cases} x^2 \cos \frac{\pi}{x}, & \text{agar } 0 < x \leq 1, \\ 0, & \text{agar } x = 0 \end{cases}$$

tenglama bilan aniqlangan egri chiziq uzunlikka ega bo'lishi isbotlansin.

◀ Bu funksiya $[0, 1]$ segmentda uzluksiz bo'ladi. $[0, 1]$ segmentning ixtiyoriy

$$P = \{x_0, x_1, \dots, x_{n-1}, x_n\}$$

bo'laklashini olib,

$$S(P) = \sum_{k=0}^{n-1} |f(x_{k+1}) - f(x_k)|$$

yig'indini qaraymiz. Lagranj teoremasidan foydalanib topamiz:

$$S(P) = \sum_{k=0}^{n-1} |f'(\xi_k)|(x_{k+1} - x_k).$$

$$\text{Agar } |f'(x)| = \left| 2x \cos \frac{\pi}{x} + \pi \sin \frac{\pi}{x} \right| < 6, \quad (0 < x \leq 1)$$

bo'lishini e'tiborga olsak, keyingi munosabatdan

$$S(P) \leq 6 \sum_{k=0}^{n-1} (x_{k+1} - x_k) = 6$$

bo'lishi kelib chiqadi. Demak, qaralayotgan egri chiziq uzunlikka ega. ►

Eslatma. Egri chiziqning uzunlikka ega bo'lishi va uning uzunligini limit orqali ta'riflash mumkin.

Aytaylik, ushbu

$$\begin{cases} x = x(t), \\ y = y(t) \end{cases} \quad (\alpha \leq t \leq \beta)$$

tenglamalar sistemasi Jordan chizig'ining ifodasi bo'lsin, bunda $x(t)$, $y(t)$ funksiyalar $[\alpha, \beta]$ da uzluksiz.

$[\alpha, \beta]$ segmentning

$$P = \{t_0, t_1, \dots, t_{n-1}, t_n\}$$

bo'laklashini olib, so'ngra egri chiziqning

$$(x(t_0), y(t_0)), (x(t_1), y(t_1)), \dots, (x(t_n), y(t_n)))$$

nuqtalarini to'g'ri chiziq kesmalari yordamida birlashtirib, egri chiziqqa chizilgan siniq chiziqni hosil qilamiz. Uning perimetri

$$L = \sum_{k=0}^{n-1} \sqrt{[x(t_{k+1}) - x(t_k)]^2 + [y(t_{k+1}) - y(t_k)]^2}$$

bo'ladi.

2- ta'rif. Agar $\forall \varepsilon > 0$ olinganda ham shunday $\delta > 0$ son topilsaki, diametri $\lambda_p > \delta$ bo'lgan $[\alpha, \beta]$ segmentning ixtiyoriy P bo'laklashi uchun

$$|L(P) - l| < \varepsilon$$

tengsizlik bajarilsa, ya'ni

$$\lim_{\lambda_p \rightarrow 0} L(P) = l$$

bo'lsa, egri chiziq uzunlikka ega deyilib, l esa uning uzunligi deyiladi.

3°. Egri chiziq uzunligini hisoblash formulalari. 40- ma'ruzada egri chiziq uzunligini hisoblash formulalari bayon etilgan. Egri chizikli integrallarda egri chiziqning uzunligi muhimligini e'tiborga olib, tegishli formulalarni keltiramiz.

1) \overline{AB} egri chiziq $y = f(x)$, ($a \leq x \leq b$) tenglama bilan berilgan bo'lib, $f(x)$ funksiya $[a, b]$ da uzluksiz va uzluksiz $f'(x)$ hosilaga ega bo'lsin. U holda \overline{AB} egri chiziqning uzunligi quyidagiga teng bo'ladi:

$$l = \int_a^b \sqrt{1 + f'^2(x)} dx.$$

2) \overline{AB} egri chiziq

$$\begin{cases} x = x(t), \\ y = y(t) \end{cases} \quad (\alpha \leq t \leq \beta)$$

tenglamalar sistemasi bilan aniqlansin. Bunda $x(t)$, $y(t)$ funksiyalar $[\alpha, \beta]$ segmentda uzluksiz va uzluksiz $x'(t)$, $y'(t)$ hosilalarga ega bo'lib,

$$A = (x(\alpha), y(\alpha)), \quad B = (x(\beta), y(\beta))$$

bo'lsin. U holda egri chiziqning uzunligi

$$l = \int_{\alpha}^{\beta} \sqrt{x'^2(t) + y'^2(t)} dt$$

bo'ladi.

3) \overline{AB} egri chiziq qutb koordinatalar sistemasida

$$\rho = \rho(\theta), \quad (\alpha \leq \theta \leq \beta)$$

tenglama bilan aniqlansin, bunda $\rho(\theta)$ funksiya $[\alpha, \beta]$ segmentda uzluksiz va uzluksiz $\rho'(\theta)$ hosilaga ega. U holda \overline{AB} egri chiziqning uzunligi quyidagiga teng bo'ladi:

$$l = \int_{\alpha}^{\beta} \sqrt{\rho'^2(\theta) + \rho^2(\theta)} d\theta.$$

Mashqlar

$$1. \text{ Ushbu } f(x) = \begin{cases} \sqrt{x} \cos \frac{\pi}{x}, & \text{agar } 0 < x \leq 1 \text{ bo'lsa,} \\ 0, & \text{agar } x = 0 \text{ bo'lsa} \end{cases}$$

tenglamalar bilan aniqlangan egri chiziqning uzunlikka ega emasligi isbotlansin.

2. Agar \widetilde{AB} yoy l uzunlikka ega bo'lib,

$$\widetilde{AB} = \widetilde{AA_1} + \widetilde{A_1A_2} + \dots + \widetilde{A_{n-1}B}$$

bo'lsa, u holda

$$\widetilde{AA_1}, \widetilde{A_1A_2}, \dots, \widetilde{A_{n-1}B}$$

yoylar ham l_1, \dots, l_{n-1} uzunliklarga ega va

$$l = l_1 + l_2 + \dots + l_{n-1}$$

bo'lishi isbotlansin (additivlik xossasi).

89- ma'ruza

Birinchi tur egri chiziqli integrallar

Ma'lumki, integral matematik analizning muhim tushunchalaridan hisoblanadi. Uning umumlashtirishlaridan biri — ma'ruzalarda bayon etilgan ikki o'zgaruvchili funksiyaning tekislikdagi to'plam bo'yicha ikki karrali integralidir. Ayni paytda, ikki o'zgaruvchili funksiya integralini boshqacha umumlashtirish (bu konkret amaliy masalalarni hal qilishda zarur ekanligidan kelib chiqqan) ham mumkin. Quyida keltiriladigan egri chiziqli integral shular jumlasidandir.

1°. Birinchi tur egri chiziqli integral tushunchasi. Tekislikda sodda uzunlikka ega bo'lgan \widetilde{AB} egri chiziqni qaraylik (47- chizma).

Bu egri chiziqda A dan B ga qarab yo'nalishni musbat yo'nalish deb, uning

$$A_0, A_1, \dots, A_{n-1}, A_n \quad (A_0 = A, A_n = B)$$

nuqtalar yordamida hosil qilingan

$$P = \{A_0, A_1, \dots, A_{n-1}, A_n\}$$

bo'laklashini olamiz. Natijada \widetilde{AB} egri chiziq

$$\widetilde{A_k A_{k+1}} \quad (k = 0, 1, 2, \dots, n-1)$$

bo'lakchalarga ajraladi. Uning uzunligini ΔS_k ($k = 0, 1, 2, \dots, n-1$) deyilsa, P bo'laklashning diametri

$\lambda_p = \max_k \{\Delta S_k\}$ bo'ladi.

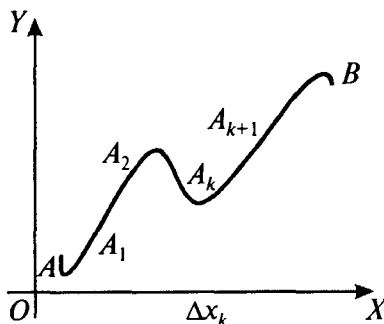

47- chizma.

Aytaylik, bu \overline{AB} egri chiziqda $f(x,y)$ funksiya aniqlangan bo'lsin $((x,y) \in \overline{AB})$. Har bir $A_k A_{k+1}$ da ixtiyoriy (ξ_k, η_k) nuqtani olib, so'ngra bu nuqtadagi $f(x,y)$ funksiyaning qiymati $f((\xi_k, \eta_k))$ ni ΔS_k ga ko'paytirib ushbu

$$\sigma = \sum_{k=0}^{n-1} f(\xi_k, \eta_k) \Delta S_k$$

yig'indini hosii qilamiz.

Ta'rif. Agar $\forall \varepsilon > 0$ olinganda ham shunday $\delta > 0$ son topilsaki, \overline{AB} egri chiziqning diametri $\lambda_p > 0$ bo'lgan har qanday P bo'laklash uchun tuzilgan σ yig'indi ixtiyoriy $(\xi_k, \eta_k) \in A_k A_{k+1}$ nuqtalarda

$$|\sigma - J| < \varepsilon$$

tengsizlikni bajarsa, $f(x,y)$ funksiya \overline{AB} egri chiziq bo'yicha integralanuvchi deyilib, J son esa $f(x,y)$ funksiyaning \overline{AB} egri chiziq bo'yicha birinchi tur egri chizikli integrali deyiladi. U

$$\int_{\overline{AB}} f(x,y) ds$$

kabi belgilanadi. Demak,

$$\int_{\overline{AB}} f(x,y) ds = \lim_{\lambda_p \rightarrow 0} \sum_{k=0}^{n-1} f(\xi_k, \eta_k) \Delta S_k .$$

Keltirilgan ta'rifdan ko'rinadiki, $f(x,y)$ funksiyaning birinchi tur egri chizikli integrali \overline{AB} egri chiziqning yo'nalishiga bog'liq bo'lmaydi:

$$\int_{\overline{AB}} f(x,y) ds = \int_{\overline{BA}} f(x,y) ds .$$

2°. Birinchi tur egri chizikli integralning mavjudligi va uni hisoblash. Birinchi tur egri chizikli integral ta'rifidan ko'rinadiki, u berilgan $f(x,y)$ funksiya va \overline{AB} egri chiziqqa bog'liq bo'ladi.

Faraz qilaylik, \overline{AB} sodda silliq egri chiziq ushbu

$$\begin{cases} x = x(t), \\ y = y(t) \end{cases} \quad (\alpha \leq t \leq \beta)$$

tenglamalar sistemasi bilan aniqlangan va

$$A = (x(\alpha), y(\beta)), \quad B = (x(\beta), y(\beta))$$

bo'lsin. Shu egri chiziqda $f(x,y)$ funksiya berilgan.

Teorema. Agar $f(x,y)$ funksiya \widetilde{AB} da uzluksiz bo'lsa, u holda birinchi tur egri chizikli integral

$$\int_{AB} f(x, y) ds$$

mavjud bo'lib, quyidagi tenglik o'rinli bo'ladi:

$$\int_{\widetilde{AB}} f(x, y) ds = \int_{\alpha}^{\beta} f(x(t), y(t)) \sqrt{x'^2(t) + y'^2(t)} dt.$$

◀ $[\alpha, \beta]$ segmentning

$$P = \{t_0, t_1, \dots, t_{n-1}, t_n\} \quad (t_0 = \alpha, \quad t_n = \beta)$$

bo'laklari \widetilde{AB} egri chiziqda

$$A_k = (x(t_k), y(t_k)), \quad (k = 0, 1, 2, \dots, n)$$

nuqtalarni hosil qilib, u o'z navbatida egri chiziqning

$$\tilde{P} = \{A_0, A_1, \dots, A_{n-1}, A_n\}, \quad (A_0 = A, A_n = B)$$

bo'laklashini yuzaga keltiradi. Bu bo'laklashga nisbatan quyidagi

$$\sigma = \sum_{k=0}^{n-1} f(\xi_k, \eta_k) \Delta S_k \quad (1)$$

yig'indini tuzamiz. Bunda $(\xi_k, \eta_k) \in \widetilde{A_k A_{k+1}}$, ΔS_k esa $\widetilde{A_k A_{k+1}}$ egri chiziq uzunligi. Ma'lumki,

$$\Delta S_k = \int_{t_k}^{t_{k+1}} \sqrt{x'^2(t) + y'^2(t)} dt$$

bo'ladi. O'rta qiymat haqidagi teoremdan foydalanib topamiz:

$$\Delta S_k = \sqrt{x'^2(\theta_k) + y'^2(\theta_k)} \Delta t_k$$

$$(t_k < \theta_k < t_{k+1}, \Delta t_k = t_{k+1} - t_k).$$

Endi $\xi_k = x(\theta_k), \eta_k = y(\theta_k)$

deb qaraymiz. Ravshanki, $(\xi_k, \eta_k) \in A_k A_{k+1}$. Modomiki, $f(x, y)$ funktsiya \overline{AB} egri chiziqda berilgan ekan, u holda $f(x, y) = f(x(t), y(t))$ bo'ladi. Natijada (1) yig'indi ushbu

$$\sigma = \sum_{k=0}^{n-1} f(x(\theta_k), y(\theta_k)) \sqrt{x'^2(\theta_k) + y'^2(\theta_k)} \Delta t_k \quad (2)$$

ko'rinishga keladi.

$x(t), y(t)$ funksiyalar $[\alpha, \beta]$ da uzluksiz bo'lganligi sababli

$$\max_k \{\Delta t_k\} \rightarrow 0 \text{ da } \lambda_p = \max_k \{\Delta S_k\} \rightarrow 0$$

bo'ladi. Yana

$$f(x(t), y(t)) \sqrt{x'^2(t) + y'^2(t)}$$

funktsiya $[\alpha, \beta]$ da uzluksiz bo'lganligi uchun u $[\alpha, \beta]$ da integrallanuvchi bo'ladi.

(2) tenglikda limitga o'tib topamiz:

$$\begin{aligned} \lim_{\lambda_p \rightarrow 0} \sigma &= \lim_{\max\{\Delta t_k\} \rightarrow 0} \sum_{k=0}^{n-1} f(x(\theta_k), y(\theta_k)) \sqrt{x'^2(\theta_k) + y'^2(\theta_k)} \Delta t_k = \\ &= \int_{\alpha}^{\beta} f(x(t), y(t)) \sqrt{x'^2(t) + y'^2(t)} dt. \end{aligned}$$

$$\text{Demak, } \int_{\overline{AB}} f(x, y) ds = \int_{\alpha}^{\beta} f(x(t), y(t)) \sqrt{x'^2(t) + y'^2(t)} dt. \quad (3)$$

Bu teorema birinchi tur egri chizikli integralning mavjudligini ifodalash bilan birga uni hisoblash imkonini ham beradi.

1- natija. Aytaylik, \overline{AB} egri chiziq $y = y(x)$ ($a \leq x \leq b$) tenglama bilan aniqlangan bo'lib, $y(x)$ funktsiya $[a, b]$ da uzluksiz hamda uzluksiz $y'(x)$ hosilaga ega bo'lsin ($y(a) = A, y(b) = B$).

Agar $f(x, y)$ funktsiya esa shu \overline{AB} egri chiziqda uzluksiz bo'lsa,

$$\int_{\overline{AB}} f(x, y) ds \text{ birinchi tur egri chizikli integral mavjud bo'lib,}$$

$$\int_{\widetilde{AB}} f(x, y) ds = \int_a^b f(x, y(x)) \sqrt{1 + y'^2(x)} dx \quad (4)$$

bo'ladi.

2- natija. Aytaylik, \widetilde{AB} egri chiziq qutb koordinatalari sistema-sida

$$\rho = \rho(\theta), \quad (\alpha \leq \theta \leq \beta)$$

tenglama bilan aniqlangan bo'lsin, bunda $\rho = \rho(\theta)$ funksiya $[\alpha, \beta]$ segmentda uzluksiz va uzluksiz ρ' hosilaga ega. Bu egri chiziqda $f(x, y)$ funksiya aniqlangan va uzluksiz. U holda

$$\int_{\widetilde{AB}} f(x, y) ds$$

birinchi tur egri chizikli integral mavjud bo'lib,

$$\int_{\widetilde{AB}} f(x, y) ds = \int_{\alpha}^{\beta} f(\rho \cos \theta, \rho \sin \theta) \sqrt{\rho^2 + \rho'^2} d\theta \quad (5)$$

bo'ladi.

1- misol. Ushbu $J = \int_{\widetilde{AB}} \frac{x}{y} ds$

integral hisoblansin, bunda \widetilde{AB} egri chiziq $- y^2 = 2x$ parabolaning $(1, \sqrt{2})$, $(2, 2)$ nuqtalari orasidagi qismi.

◀ (4) formuladan foydalanib topamiz:

$$J = \int_1^2 \frac{x}{\sqrt{2x}} \sqrt{1 + (\sqrt{2x})'^2} dx,$$

$$J = \int_1^2 \frac{x}{\sqrt{2x}} \frac{\sqrt{1+2x}}{\sqrt{2x}} dx = \frac{1}{2} \int_1^2 \sqrt{1+2x} dx = \frac{1}{6} (5\sqrt{5} - 3\sqrt{3}). \blacktriangleright$$

2- misol. Ushbu $J = \int_C \frac{1}{\rho} \cos \theta ds$

interal hisoblansin, bunda C – markazi $(a,0)$ nuqtada, radiusi a ga teng bo‘lgan aylana.

◀ Ma’lumki, bu aylananing tenglamasi qutb koordinatalar sistemasida

$$\rho(\theta) = 2a \cos \theta, \quad \left(-\frac{\pi}{2} \leq \theta \leq \frac{\pi}{2}\right)$$

ko‘rinishda bo‘ladi. (5) formuladan foydalanib topamiz:

$$J = \int_{-\frac{\pi}{2}}^{\frac{\pi}{2}} \frac{\cos \theta}{\rho} \sqrt{\rho^2(\theta) + \rho'^2(\theta)} d\theta = \int_{-\frac{\pi}{2}}^{\frac{\pi}{2}} d\theta = \pi. \quad \blacktriangleright$$

3°. Birinchi tur egri chiziqli integrallarning ba’zi tatbiqlari. Birinchi tur egri chiziqli integrallar yordamida egri chiziqning uzunligini, jismning massasini, og‘irlik markazini, inersiya momentlarini topish kabi masalalar hal etiladi.

1. Tekislikda uzunlikka ega bo‘lgan \overline{AB} egri chiziqning uzunligi ushbu

$$S = \int_{\overline{AB}} ds \quad (6)$$

integral yordamida topiladi.

2. Tekislikda uzunlikka ega bo‘lgan \overline{AB} egri chiziq bo‘yicha massa tarqatilgan bo‘lib, uning zichligi $\rho = \rho(x, y)$ bo‘lsin. Bu egri chiziqning massasi ushbu

$$m = \int_{\overline{AB}} \rho(x, y) ds \quad (7)$$

integral yordamida, og‘irlik markazining koordinatalari esa

$$x_0 = \frac{1}{m} \int_{\overline{AB}} x\rho(x, y) ds, \quad y_0 = \frac{1}{m} \int_{\overline{AB}} y\rho(x, y) ds \quad (8)$$

integrallar yordamida topiladi.

3. Tekislikda uzunlikka ega bo'lgan \overline{AB} egri chiziqning OX va OY koordinata o'qlariga nisbatan statik momentlari ushbu

$$S_x = \int_{\overline{AB}} y ds, \quad S_y = \int_{\overline{AB}} x ds \quad (9)$$

formula bilan, shu o'qlarga nisbatan inersiya momentlari esa quyidagi

$$J_x = \int_{\overline{AB}} y^2 ds, \quad J_y = \int_{\overline{AB}} x^2 ds \quad (10)$$

inegrallar yordamida topiladi.

3- misol. Ushbu

$$\begin{cases} x(t) = a \cos^3 t, \\ y(t) = a \sin^3 t \end{cases} \quad (0 \leq t \leq 2\pi)$$

tenglamalar sistemasi bilan aniqlanadigan \overline{AB} egri chiziq (astroida) ning uzunligi topilsin.

◀ Astroida koordinatalari o'qlariga nisbatan simmetrik bo'lishini e'tiborga olib, (6) formuladan foydalanib topamiz:

$$\begin{aligned} S &= \int_{\overline{AB}} ds = 4 \int_0^{\frac{\pi}{2}} \sqrt{x'^2(t) + y'^2(t)} dt = \int_0^{\frac{\pi}{2}} \sqrt{(-3a \cos^2 t \sin t)^2 + (3a \sin^2 t \cos t)^2} dt = \\ &= 4 \int_0^{\frac{\pi}{2}} \sqrt{\frac{9a^2}{4} \sin^2 2t} dt = 6a \int_0^{\frac{\pi}{2}} \sin 2t dt = 6a. \quad \blacktriangleright \end{aligned}$$

4- misol. Chizig'ining zichligi $\rho(x, y) = |y|$ bo'lgan \overline{AB} massali egri chiziq — $y^2 = 2px$, $\left(0 \leq x \leq \frac{p}{2}\right)$ parabolaning massasi hamda og'irlik markazi topilsin.

◀ (7) formulaga ko'ra parabolaning massasi

$$m = \int_{\overline{AB}} |y| ds$$

bo'ldi. Endi birinchi tur egri chiziqli integralni (4) formulaga ko'ra aniq integralga keltirib hisoblaymiz:

$$m = \int_{-p}^p |y| \sqrt{1 + \frac{y^2}{p^2}} dy = 2 \frac{1}{p} \int_0^p y \sqrt{p^2 + y^2} dy = \frac{1}{p} \int_0^p \sqrt{p^2 + y^2} d(p^2 + y^2) =$$

$$= \frac{1}{p} \left((p^2 + y^2)^{\frac{3}{2}} \frac{2}{3} \right) \Big|_0^p = \frac{2}{3} p^2 (2\sqrt{2} - 1).$$

Qaralayotgan massali parabola og'irlik markazining koordinatlarini (8) formuladan foydalanib topamiz:

$$x_0 = \frac{1}{m} \int_{AB} x |y| ds = \frac{1}{m} \int_0^p y^3 \sqrt{p^2 + y^2} dy,$$

$$\int_0^p y^3 \sqrt{p^2 + y^2} dy = \left[\begin{array}{l} y^2 = u, \quad du = 2y dy \\ y \sqrt{p^2 + y^2} dy = dv, \quad v = \frac{1}{3} (p^2 + y^2)^{\frac{3}{2}} \end{array} \right] =$$

$$= \frac{1}{3} y^2 (p^2 + y^2) \Big|_0^p - \frac{1}{3} \int_0^p 2y (p^2 + y^2)^{\frac{3}{2}} dy = \frac{2\sqrt{2}p^5}{3} - \frac{1}{3} \cdot \frac{2}{5} (p^2 + y^2)^{\frac{5}{2}} \Big|_0^p =$$

$$= \frac{2p^5(1+\sqrt{2})}{15}.$$

$$\text{Demak, } x_0 = \frac{1}{m} \frac{2p^5(\sqrt{2}+1)}{15} = \frac{3}{2} \frac{1}{p^2(2\sqrt{2}-1)} \frac{2p^5(\sqrt{2}+1)}{15} = \frac{p^3(3\sqrt{2}+5)}{35}.$$

Xuddi shunga o'xshash

$$y_0 = \frac{1}{m} \int_{AB} y |y| ds = \frac{3(2\sqrt{2}+p)}{28} (3\sqrt{2} + \ln(1 + \sqrt{2}))$$

bo'lishi topiladi.

5- misol. Ushbu C aylana ($x^2 + y^2 = a^2$) ning uning diametriga nisbatan inersiya momenti topilsin.

◀ Berilgan aylananing parametrik tenglamasi

$$\begin{cases} x = a \cos t, \\ y = a \sin t \end{cases} \quad (0 \leq t \leq 2\pi)$$

bo'lad. Aylana diametrini OX o'qqa joylashtirib, so'ngra (10) formuladan foydalanib topamiz:

$$J_x = \int_C y^2 ds = \int_0^{2\pi} a^2 \sin^2 t + \sqrt{(a \cos t)^2 + (a \sin t)^2} dt = \\ = a^3 \int_0^{2\pi} \sin^2 t dt = \pi a^3. \blacktriangleright$$

Eslatma. Aytaylik, \overline{AB} egri chiziq fazoviy egri chiziq bo'lib, bu chiziqda $f(x, y, z)$ funksiya berilgan bo'lsin. Yuqoridagidek, $f(x, y, z)$ funksiyaning \overline{AB} egri chiziq bo'yicha birinchi tur egri chizikli integral tushunchasi kiritiladi va o'rganiladi.

Mashqlar

1. Ushbu $y = 1 - \ln \cos x$, $(0 \leq x \leq \frac{\pi}{4})$ tenglama bilan berilgan egri chiziqning uzunligi topilsin.

2. Zichligi $\rho(x, y) = \frac{1}{y^2}$ bo'lgan ushbu $y = \frac{a}{2} \left(e^{\frac{x}{a}} + e^{-\frac{x}{a}} \right)$ zanjir chiziqning massasi topilsin.

90- ma'ruza

Ikkinchi tur egri chizikli integrallar

1°. **Ikkinchi tur egri chizikli integral tushunchasi.** Tekislikda (sodda) uzunlikka ega bo'lgan \overline{AB} egri chiziqni qaraylik (48- chizma).

Bu egri chiziqning biror

$$P = \{A_0, A_1, A_2, \dots, A_n\}, \quad (A_0 = A, A_n = B)$$

bo'laklashini olamiz. Natijada \overline{AB} egri chiziq

$$\overline{A_k A_{k+1}}, \quad (k = 0, 1, 2, \dots, n-1)$$

bo'lakchalarga ajraladi. $\overline{A_k A_{k+1}}$ ning OX va OY koordinatalar o'qlari-

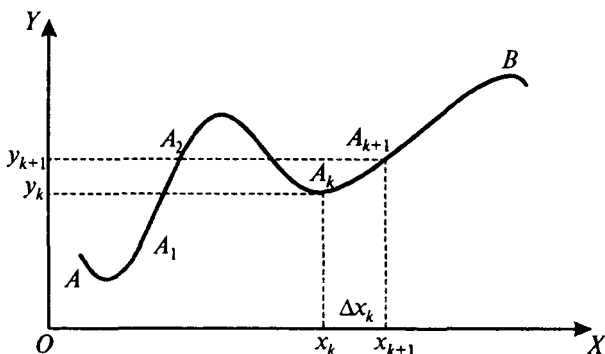

48- chizma.

dagi proyeksiyalari mos ravishda Δx_k va Δy_k bo'lsin:

$$pr_{ox} \widetilde{A_k A_{k+1}} = \Delta x_k, \quad pr_{oy} \widetilde{A_k A_{k+1}} = \Delta y_k, \quad (k = 0, 1, 2, \dots, n-1).$$

Aytaylik, \widetilde{AB} egri chiziqda $f(x, y)$ funksiya berilgan bo'lsin. Har bir $\widetilde{A_k A_{k+1}}$ da ixtiyoriy (ξ_k, η_k) nuqtalarni olib, so'ngra bu nuqtadagi funksiyaning $f(\xi_k, \eta_k)$ qiymatini Δx_k va Δy_k larga ko'paytirib, quyidagi

$$\sigma_1 = \sum_{k=0}^{n-1} f(\xi_k, \eta_k) \Delta x_k, \quad \sigma_2 = \sum_{k=0}^{n-1} f(\xi_k, \eta_k) \Delta y_k$$

yig'indilarni hosil qilamiz. Bu yig'indilar $f(x, y)$ funksiya bog'liq bo'lishi bilan birga \widetilde{AB} egri chiziqni bo'laklashga hamda har bir $\widetilde{A_k A_{k+1}}$ da olingan (ξ_k, η_k) nuqtalarga bog'liq bo'ladi.

I-ta'rif. Agar $\forall \varepsilon > 0$ olinganda ham shunday $\delta > 0$ son topilsaki, \widetilde{AB} egri chiziqning diametri $\lambda_p < \delta$ bo'lgan har qanday P bo'laklash uchun tuzilgan $\sigma_1(\sigma_2)$ yig'indi ixtiyoriy $(\xi_k, \eta_k) \in \widetilde{A_k A_{k+1}}$ nuqtalarda

$$|\sigma_1 - J_1| < \varepsilon, \quad (|\sigma_2 - J_2| < \varepsilon)$$

tengsizlik bajarilsa, $f(x, y)$ funksiya \widetilde{AB} egri chiziq bo'yicha integral-lanuvchi, J_1 son (J_2 son) esa $f(x, y)$ funksiyaning ikkinchi tur egri chizikli integrali deyiladi. Uni

$$\int_{\overline{AB}} f(x, y) dx, \quad \left(\int_{\overline{AB}} f(x, y) dy \right)$$

kabi belgilanadi. Demak,

$$\int_{\overline{AB}} f(x, y) dx = \lim_{\lambda_p \rightarrow 0} \sum_{k=0}^{n-1} f(\xi_k, \eta_k) \Delta x_k,$$

$$\left(\int_{\overline{AB}} f(x, y) dy = \lim_{\lambda_p \rightarrow 0} \sum_{k=0}^{n-1} f(\xi_k, \eta_k) \Delta y_k \right).$$

Keltirilgan ta'rifdan quyidagi xulosalar kelib chiqadi:

1) $f(x, y)$ funksiyaning \overline{AB} egri chiziq bo'yicha ikkinchi tur egri chizikli integrali ikkita bo'ladi:

$$\int_{\overline{AB}} f(x, y) dx, \quad \int_{\overline{AB}} f(x, y) dy.$$

Aytaylik, \overline{AB} egri chiziqda $P(x, y)$ va $Q(x, y)$ funksiyalar berilgan bo'lib, $\int_{\overline{AB}} P(x, y) dx, \quad \int_{\overline{AB}} Q(x, y) dy$ lar esa ularning ikkinchi tur egri chizikli integrallari bo'lsin. Ushbu

$$\int_{\overline{AB}} P(x, y) dx + \int_{\overline{AB}} Q(x, y) dy$$

yig'indi ikkinchi tur egri chizikli integralning umumiy ko'rinishi deyiladi va

$$\int_{\overline{AB}} P(x, y) dx + Q(x, y) dy$$

kabi belgilanadi:

$$\int_{\overline{AB}} P(x, y) dx + Q(x, y) dy = \int_{\overline{AB}} P(x, y) dx + \int_{\overline{AB}} Q(x, y) dy.$$

2) $f(x,y)$ funksiyaning ikkinchi tur egri chizikli integrallari \overline{AB} egri chiziqning yo'nalishiga bog'liq bo'lib,

$$\int_{\overline{BA}} f(x,y)dx = - \int_{\overline{AB}} f(x,y)dx, \quad \int_{\overline{BA}} f(x,y)dy = - \int_{\overline{AB}} f(x,y)dy$$

bo'ladi.

3) Agar \overline{AB} egri chiziq OX koordinata o'qiga (OY koordinata o'qiga) perpendikular bo'lgan to'g'ri chiziq kesmasidan iborat bo'lsa,

$$\int_{\overline{BA}} f(x,y)dy = 0, \quad \left(\int_{\overline{AB}} f(x,y)dy = 0 \right)$$

bo'ladi.

Aytaylik, $K = \overline{AB}$ sodda yopiq egri chiziq bo'lsin. Bu holda A va B nuqtalar ustma-ust tushadi (49- chizma).

Yopiq egri chiziq K da chizmada ko'rsatilganidek ikki yo'nalish bo'lib, ulardan biri musbat, ikkinchisi esa manfiy bo'ladi.

Agar kuzatuvchi K chiziq bo'yicha harakatlanganda K bilan chegaralangan to'plam har doim chap tomonda qolsa, bunday yo'nalish musbat bo'ladi, aks holda esa manfiy bo'ladi.

Shu K egri chiziqda $f(x,y)$ funksiya berilgan bo'lsin. K chiziqda ixtiyoriy ikki A va B nuqtalarni olaylik. Bu nuqtalar K egri chiziqni ikkita \overline{AnB} va \overline{BmA} egri chiziq'larga ajratadi.

Faraz qilaylik, quyidagi

$$\int_{\overline{AnB}} f(x,y)dx, \quad \int_{\overline{BmA}} f(x,y)dx$$

integrallar mavjud bo'lsin. Ushbu

$$\int_{\overline{AnB}} f(x,y)dx + \int_{\overline{BmA}} f(x,y)dx$$

yig'indi $f(x,y)$ funksiyaning K yopiq egri chiziq bo'yicha ikkinchi tur egri chizikli integrali deyiladi. Uni

$$\int_K f(x,y)dx \text{ yoki } \oint_K f(x,y)dx$$

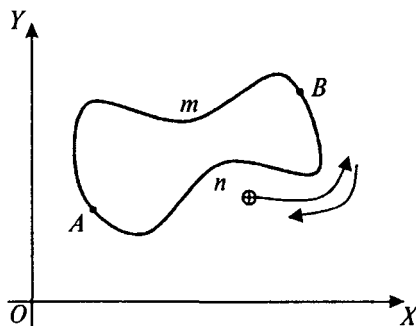

49- chizma.

kabi belgilanadi. Bu holda K yopiq chiziqning musbat yo'nalishi olinadi. Demak,

$$\int_K f(x, y) dx = \int_{A \rightarrow B} f(x, y) dx + \int_{B \rightarrow A} f(x, y) dx .$$

Xuddi shunga o'xshash

$$\int_K f(x, y) dx$$

hamda umumiy holda

$$\int_K P(x, y) dx + Q(x, y) dy$$

integrallar ta'riflanadi.

Aytaylik, \overline{AB} fazodagi sodda uzunlikka ega bo'lgan egri chiziq bo'lib, bu egri chiziqda $f(x, y, z)$ funksiya berilgan bo'lsin. Yuqoridagidek, $f(x, y, z)$ funksiyaning ikkinchi tur egri chiziqli integrallari ta'riflanadi va ular quyidagicha belgilanadi:

$$\int_{\overline{AB}} f(x, y, z) dx, \int_{\overline{AB}} f(x, y, z) dy, \int_{\overline{AB}} f(x, y, z) dz, \\ \int_{\overline{AB}} P(x, y, z) dx + Q(x, y, z) dy + R(x, y, z) dz .$$

2°. Ikkinchi tur egri chiziqli integralning mavjudligi va uni hisoblash. Faraz qilaylik, \overline{AB} egri chiziq ushbu

$$\begin{cases} x = x(t) \\ y = y(t) \end{cases}, \quad (\alpha \leq t \leq \beta) \quad (1)$$

tenglamalar sistemasi bilan aniqlangan bo'lib, $x = x(t)$ funksiya $[\alpha, \beta]$ da uzluksiz, $x'(t)$ hosilaga ega, $y(t)$ funksiya esa $[\alpha, \beta]$ da uzluksiz hamda

$$A = (x(\alpha), y(\alpha)), \quad B = (x(\beta), y(\beta))$$

bo'lsin. t parametr α dan β ga qarab o'zgarganda \overline{AB} egri chiziqning $(x, y) = (x(t), y(t))$ nuqtasi A dan B ga qarab \overline{AB} ni chizib borsin.

1- teorema. Agar $f(x,y)$ funksiya \widetilde{AB} da uzluksiz bo'lsa, u holda ikkinchi tur egri chiziqli integral

$$\int_{\widetilde{AB}} f(x,y) dx$$

mavjud bo'lib, u quyidagiga teng:

$$\int_{\widetilde{AB}} f(x,y) dx = \int_{\alpha}^{\beta} f(x(t), y(t)) x'(t) dt \quad (2)$$

◀ $[\alpha, \beta]$ segmentning

$$P = \{t_0, t_1, \dots, t_{n-1}, t_n\}, \quad (t_0 = \alpha, t_n = \beta)$$

bo'laklari \widetilde{AB} egri chiziqda

$$A_k = (x(t_k), y(t_k)), \quad (k = 0, 1, 2, 3, \dots, n)$$

nuqtalarni hosil qilib, ular o'z navbatida \widetilde{AB} egri chiziqning

$$P^* \{A_0, A_1, \dots, A_{n-1}, A_n\}, \quad (A_0 = A, A_n = B)$$

bo'laklashini yuzaga keltiradi. Bu bo'laklashga nisbatan quyidagi

$$\sigma_1 = \sum_{k=0}^{n-1} f(\xi_k, \eta_k) \Delta x_k \quad (3)$$

yig'indini tuzamiz. Bunda Δx_k miqdor $\widetilde{A_k A_{k+1}}$ ning OX o'qidagi proyeksiyasi bo'lib,

$$\Delta x_k = x(t_{k+1}) - x(t_k)$$

bo'ladi. Ayni paytda,

$$f(\xi_k, \eta_k) = f(x(\tau_k), y(\tau_k)), \quad (\tau_k \in [t_k, t_{k+1}])$$

tenglikka ega bo'lamiz. Endi

$$\Delta x_k = \int_{t_k}^{t_{k+1}} x'(t) dt$$

bo'lishini e'tiborga olib, (3) tenglikni quyidagi ko'rinishda yozib olamiz:

$$\sigma_1 = \sum_{k=0}^{n-1} f(x(\tau_k), y(\tau_k)) \int_{t_k}^{t_{k+1}} x'(t) dt = \sum_{k=0}^{n-1} \int_{t_k}^{t_{k+1}} f(x(\tau_k), y(\tau_k)) x'(t) dt .$$

Ravshanki, ushbu

$$J_1 = \int_{\alpha}^{\beta} f(x(t), y(t)) x'(t) dt$$

integral mavjud, uni quyidagicha

$$J_1 = \sum_{k=0}^{n-1} \int_{t_k}^{t_{k+1}} f(x(t), y(t)) x'(t) dt$$

deb yozib, so'ngra

$$\sigma_1 - J_1 = \sum_{k=0}^{n-1} \int_{t_k}^{t_{k+1}} [f(x(\tau_k), y(\tau_k)) - f(x(t), y(t))] x'(t) dt$$

ayirmani qaraymiz.

$f(x(t), y(t))$ funksiya $[\alpha, \beta]$ da uzluksiz. U holda $\forall \varepsilon > 0$ olinganda ham shunday $\delta > 0$ topiladiki, bunda barcha $\Delta t_k = t_{k+1} - t_k$ lar δ dan kichik bo'lganda $f(x(t), y(t))$ funksiyaning tebranishi ε dan kichik bo'ladi. $x'(t)$ funksiya esa $[\alpha, \beta]$ da uzluksiz, demak, chegaralangan:

$$|x'(t)| < M .$$

Shunday qilib,

$$|\sigma_1 - J_1| < \varepsilon M (\beta - \alpha)$$

bo'ladi. Keyingi munosabatdan

$$\lim_{\lambda, \rho \rightarrow 0} \sigma_1 = J_1$$

bo'lishi kelib chiqadi. Bu tenglik integralning mavjudligi va (2) tenglikning o'rinli bo'lishini isbotlaydi. ►

Aytaylik, (1) sistemadagi $x(t)$, $y(t)$ funksiyalar $[\alpha, \beta]$ da uzluksiz bo'lib, $y(t)$ funksiya esa uzluksiz $y'(t)$ hosilaga ega bo'lsin.

2- teorema. Agar $f(x, y)$ funksiya \overline{AB} da uzluksiz bo'lsa, u holda ikkinchi tur egri chiziqli integral

$$\int_{\widetilde{AB}} f(x, y) dx$$

mavjud bo'lib, quyidagi tenglik o'rinli bo'ladi:

$$\int_{\widetilde{AB}} f(x, y) dy = \int_{\alpha}^{\beta} f(x(t), y(t)) y'(t) dt. \quad (4)$$

Aytaylik, (1) sistemadagi $x(t)$, $y(t)$ funksiyalar $[\alpha, \beta]$ da uzluksiz $x'(t)$, $y'(t)$ hosilalarga ega bo'lsin.

3- teorema. Agar $P(x, y)$ va $Q(x, y)$ funksiyalar \widetilde{AB} da uzluksiz bo'lsa, u holda egri chiziqli integral

$$\int_{\widetilde{AB}} P(x, y) dx + Q(x, y) dy$$

mavjud bo'lib,

$$\begin{aligned} & \int_{\widetilde{AB}} P(x, y) dx + Q(x, y) dy = \\ & = \int_{\alpha}^{\beta} [P(x(t), y(t)) x'(t) + Q(x(t), y(t)) y'(t)] dt \end{aligned} \quad (5)$$

bo'ladi.

Bu teoremlar yuqoridagi 1- teorema kabi isbotlanadi. Keltirilgan teoremlar ikkinchi tur egri chiziqli integralning mavjudligini isbotlash bilan birga ularning aniq integrallarga (Riman integrallariga) kelishini ifodalaydi. Binobarin, egri chiziqli integrallarni hisoblash imkonini beradi. Egri chiziqli integrallar (2), (4) va (5) formulalar yordamida hisoblanadi.

Agar \widetilde{AB} egri chiziq ushbu

$$y = y(x), \quad (a \leq x \leq b); \quad x = x(y), \quad (c \leq y \leq d)$$

tenglamalar bilan berilgan bo'lsa, u holda egri chiziqli integrallar birmuncha sodda ko'rinishga ega bo'ladi. Aytaylik, \widetilde{AB} egri chiziq

$$y = y(x), \quad (a \leq x \leq b)$$

tenglama bilan berilgan bo‘lib, $y(x)$ funksiya $[a, b]$ da uzluksiz $y'(x)$ hosilaga ega bo‘lsin. U holda (2) va (5) formulalar quyidagi

$$\int_{\widetilde{AB}} f(x, y) dx = \int_a^b f(x, y(x)) dx, \quad (6)$$

$$\int_{\widetilde{AB}} P(x, y) dx + Q(x, y) dy = \int_a^b [P(x, y(x)) + Q(x, y(x))y'(x)] dx \quad (7)$$

ko‘rinishga keladi. Aytaylik, \widetilde{AB} egri chiziq

$$x = x(y), \quad (c \leq y \leq d)$$

tenglama bilan berilgan bo‘lib, $x = x(y)$ funksiya $[c, d]$ da uzluksiz $x'(y)$ hosilaga ega bo‘lsin. U holda (4) va (5) formulalar quyidagi

$$\int_{\widetilde{AB}} f(x, y) dy = \int_c^d f(x(y), y) dy, \quad (8)$$

$$\int_{\widetilde{AB}} P(x, y) dx + Q(x, y) dy = \int_c^d [P(x(y), y)x'(y) + Q(x(y), y)] dy \quad (9)$$

ko‘rinishga keladi.

1- misol. Ushbu

$$J_1 = \int_{\widetilde{AB}} (x^2 - y^2) dx, \quad J_2 = \int_{\widetilde{AB}} (x^2 - y^2) dy$$

integrallar hisoblansin. Bunda \widetilde{AB} egri chiziq $y = x^2$ parabolaning absissalari $x = 0$, $x = 2$ bo‘lgan nuqtalari orqasidagi qismi.

◀ \widetilde{AB} egri chiziq $y = x^2$ tenglama bilan aniqlanishini e‘tiborga olib, J_1 integralni hisoblashda (6) formuladan foydalanamiz:

$$J_1 = \int_{\widetilde{AB}} (x^2 - y^2) dx = \int_0^2 (x^2 - x^4) dx = -\frac{56}{15}.$$

J_2 integralda integrallash egri chizig‘i $x^2 = y$ bo‘lib, (8) formula-ga ko‘ra quyidagi natijani olamiz:

$$J_2 = \int_{\overline{AB}} (x^2 - y^2) dy = \int_0^4 (y - y^2) dy = -\frac{40}{3}.$$

2- misol. Ushbu $\int_{\overline{AB}} y^2 dx + x^2 dy$

integral hisoblansin, bunda \overline{AB} egri chiziq $\frac{x^2}{a^2} + \frac{y^2}{b^2} = 1$ ellipsning yuqori yarim tekislikdagi qismi.

◀ Bu ellipsning parametrik tenglamasi

$$\begin{cases} x = a \cos t, \\ y = b \sin t \end{cases}$$

bo'ladi. $A = (a, 0)$ nuqtaga parametrlarning $t = 0$ qiymati, $B = (-a, 0)$ nuqtaga esa $t = \pi$ qiymati mos kelib, t parametr 0 dan π gacha o'zgarganda (x, y) nuqta A dan B ga qarab ellipsning yuqori yarim tekislikdagi qismini chizadi. Ravshanki,

$$P(x, y) = y^2, \quad Q(x, y) = x^2$$

funksiyalar \overline{AB} da uzluksiz. Berilgan integralni (5) formuladan foydalanib hisoblaymiz:

$$\begin{aligned} \int_{\overline{AB}} y^2 dx + x^2 dy &= \int_0^\pi [b^2 \sin^2 t (-a \sin t) + a^2 \cos^2 t b \cos t] dt = \\ &= ab \int_0^\pi (a \cos^3 t - b \sin^3 t) dt = -\frac{4}{3} ab^2. \quad \blacktriangleright \end{aligned}$$

3- misol. Ushbu $\oint_K 2xy dx - x^2 dy$

integral hisoblansin, bunda K – yopiq chiziqning $O(0, 0)$ va $A(2, 1)$ nuqtalarini birlashtiruvchi to'g'ri chiziq kesmasi hamda $y^2 = \frac{1}{2}x$ parabola yoyidan tashkil topgan yopiq egri chiziq (50- chizma).

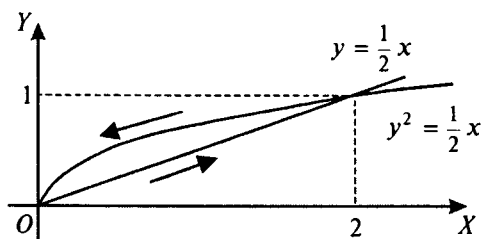

50- chizma.

Ravshanki,

$$\oint_k 2xydx - x^2 dy = \int_{\vec{OA}} 2xydx + x^2 dy + \int_{\vec{AO}} 2xydx + x^2 dy.$$

\vec{OA} kesmada $x = 2y$ bo'lib, (9) formulaga ko'ra

$$\int_{\vec{OA}} 2xydx + x^2 dy = \int_0^1 [2 \cdot 2y^2 \cdot 2 - 4y^2] dy = \frac{4}{3}$$

natijaga ega bo'lamiz.

\vec{AO} yoyda $x = 2y^2$ bo'lib, yana (9) formulaga ko'ra

$$\int_{\vec{AO}} 2xydx + x^2 dy = \int_0^1 [2 \cdot 2y^2 \cdot y \cdot 4 \cdot y - 4y^4] dy = -\frac{12}{5}$$

bo'ladi. Demak, $\oint_k 2xydx + x^2 dy = \frac{4}{3} - \frac{12}{5} = -\frac{16}{15}$.

3°. Ikkinchi tur egri chiziqli integralning ba'zi tatbiqlari. Ikkinchi tur egri chiziqli integrallar yordamida tekis shaklning yuzi, kuch ta'sirida bo'lgan maydonda bajarilgan ish topiladi hamda boshqa turli fizik va mexanik masalalar hal etiladi. Tekislikda biror yuzaga ega bo'lgan D shakl berilgan bo'lib, uning chegarasi to'g'rilanuvchi yopiq ∂D chiziqdan iborat bo'lsin. Bu shaklning yuzi ushbu

$$\mu D = \int_{\partial D} xdy, \quad \mu D = - \int_{\partial D} ydx, \quad \mu D = \frac{1}{2} \int_{\partial D} xdy - ydx \quad (10)$$

formulalar yordamida topiladi.

Aytaylik, uzunlikka ega bo'lgan \widetilde{AB} egri chiziq berilgan bo'lib, uning har bir (x,y) nuqtasi ushbu

$$\vec{F}(x, y) = P(x, y)\vec{i} + Q(x, y)\vec{j}$$

kuch ta'sirida bo'lsin. U holda A nuqtani B nuqtaga o'tkazishda bajarilgan ish quyidagicha hisoblanadi:

$$W = \int_{\widetilde{AB}} P(x, y)dx + Q(x, y)dy. \quad (11)$$

4- misol. Ushbu
$$\begin{cases} x = a \cos t, \\ y = b \sin t \end{cases} \quad (0 \leq t \leq 2\pi)$$

ellips bilan chegaralangan shaklning yuzi topilsin.

◀ Bu shaklning yuzi (10) formulaga ko'ra

$$\mu D = \frac{1}{2} \oint_{\partial(D)} xdy - ydx$$

bo'ladi. Egri chizikli integralni hisoblaymiz:

$$\begin{aligned} \mu D &= \frac{1}{2} \int_0^{2\pi} (a \cos t \cdot b \cos t + b \sin t \cdot a \sin t) dt = \\ &= \frac{1}{2} ab \int_0^{2\pi} (\cos^2 t + \sin^2 t) dt = \pi ab. \quad \blacktriangleright \end{aligned}$$

5- misol. \widetilde{AB} egri chiziq $y = x^3$ chiziqning $(0,0)$ va $(1,1)$ nuqtalari orasidagi qismi bo'lib, uning har bir nuqtasi

$$\vec{F}(x, y) = 4x^6\vec{i} + xy\vec{j}$$

kuch ta'sirida bo'lsin. Bu kuch ta'sirida bajarilgan ish topilsin.

◀ Izlanayotgan ishni (11) formuladan foydalanib topamiz. Bu holda

$$P(x, y) = 4x^6, \quad Q(x, y) = xy$$

bo'lishini e'tiborga olsak, u holda bajarilgan ish

$$W = \int_{\widetilde{AB}} 4x^6 dx + xy dy = \int_0^1 (4x^6 + x \cdot x^3 \cdot 3x^2) dx = 1$$

bo'ladi. ▶

Mashqlar

1. Ikkinchi tur egri chiziqli integrallar ham aniq integral xossalari kabi xossalarga ega. Bu xossalari keltirilsin va ular isbotlansin.

2. Birinchi va ikkinchi tur egri chiziqli integrallar ushbu

$$\int_{\overline{AB}} f(x, y) dx = \int_{\overline{AB}} f(x, y) \cos \alpha ds, \quad \int_{\overline{AB}} f(x, y) dy = \int_{\overline{AB}} f(x, y) \cos \beta ds,$$

$$\int_{\overline{AB}} P(x, y) dx + Q(x, y) dy = \int_{\overline{AB}} [P(x, y) \cos \alpha + Q(x, y) \cos \beta] ds$$

bog'lanishda bo'lishi isbotlansin, bunda α va β – mos ravishda OX va OY o'qlar bilan urinmaning yoy o'sishi tomoniga qarab yo'nalishlari orasidagi burchaklar.

3. Ushbu
$$\int_{\overline{AB}} (2a - y) dx + x dy$$

integral hisoblansin, bunda \overline{AB} yopiq chiziq quyidagi

$$\begin{cases} x = a(t - \sin t), \\ y = a(1 - \cos t) \end{cases} \quad (0 \leq t \leq 2\pi)$$

sikloidadan iborat.

4. Ushbu
$$\oint_K \frac{1}{|x|+|y|} (dx + dy)$$

integral hisoblansin, bunda K yopiq chiziq uchlari

$$A = (1, 0), \quad B = (0, 1), \quad C = (-1, 0), \quad D = (0, -1)$$

nuqtalarda bo'lgan kvadratdan iborat.

91- ma'ruza

Grin formulasi va uning tatbiqlari

1°. Grin formulasi. Tekislikda ushbu

$$y = y_1(x), \quad y = y_2(x), \quad (a \leq x \leq b, \quad y_1(x) \leq y_2(x))$$

hamda

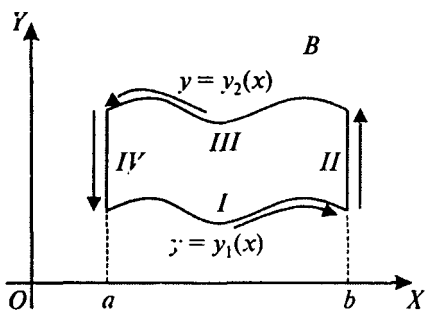

51- chizma.

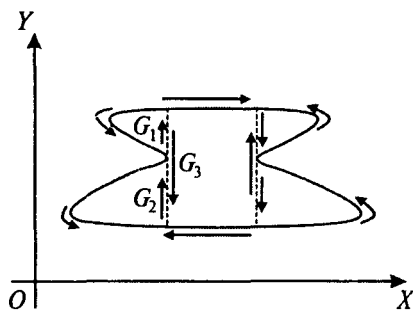

52- chizma.

$$x = a, \quad x = b$$

chiziqlar bilan chegaralangan D_1 to'pamni olaylik, bunda $y_1(x)$ va $y_2(x)$ funksiyalar $[a, b]$ da uzluksiz (51- chizma).

Ravshanki, D_1 ning chegarasi (konturi) ∂D_1 quyidagi I, II, III, IV chiziq'larga ajraladi (bunda II va IV chiziq'lar nuqталarga aylanishi mumkin).

Aytaylik, $\bar{D} = D_1 \cup \partial D_1$ da $P(x, y)$ funksiya uzluksiz bo'lib, u uzluksiz $\frac{\partial P(x, y)}{\partial y}$ xususiy hosilaga ega bo'lsin. Ushbu

$$\int_{\partial D_1} P(x, y) dx$$

egri chiziq'li integralni qaraymiz. Uni quyidagicha

$$\int_{\partial D_1} P(x, y) dx = \int_I P(x, y) dx + \int_{II} P(x, y) dx + \int_{III} P(x, y) dx + \int_{IV} P(x, y) dx$$

ko'rinishda yozib olamiz. II va IV chiziq'lar OX o'qqa perpendikular bo'lganligi sababli

$$\int_{II} P(x, y) dx = \int_{IV} P(x, y) dx = 0$$

bo'lib,

$$\int_{\partial D_1} P(x, y) dx = \int_I P(x, y) dx + \int_{III} P(x, y) dx$$

bo'ladi. Endi

$$\begin{aligned}
\int_I P(x, y) dx + \int_{III} P(x, y) dx &= \int_a^b P(x, y_1(x)) dx + \int_a^b P(x, y_2(x)) dx = \\
&= \int_a^b [P(x, y_1) - P(x, y_2)] dx = - \int_a^b P(x, y) \Big|_{y=y_1}^{y=y_2} dx = \\
&= - \int_a^b \left[\int_{y=y_1}^{y=y_2} \frac{\partial P(x, y)}{\partial y} dy \right] dx = - \iint_{D_1} \frac{\partial P(x, y)}{\partial y} dx dy
\end{aligned}$$

bo'lishini e'tiborga olsak, u holda

$$\int_{\partial D_1} P(x, y) dx - \iint_{D_1} \frac{\partial P(x, y)}{\partial y} dx dy \quad (1)$$

tenglikka ega bo'lamiz.

Faraz qilaylik, tekislikdagi G to'pam shunday bo'lsinki, uni vertikal chiziqlar yordamida yuqoridagi D_1 kabi G_k ($k = 1, 2, 3, \dots$) larga ajratish mumkin bo'lsin (52- chizma).

Bunday to'pam uchun ham (1) formula o'rinli bo'ladi:

$$\begin{aligned}
\int_{\partial G_1} P(x, y) dx &= \sum_{k=1}^n \int_{\partial G_k} P(x, y) dx = \\
&= \sum_{k=1}^n \left(- \iint_{G_k} \frac{\partial P(x, y)}{\partial y} dx dy \right) = - \iint_G \frac{\partial P(x, y)}{\partial y} dx dy.
\end{aligned}$$

Endi tekislikda ushbu

$$x = x_1(y), \quad x = x_2(y), \quad (c \leq y \leq d)$$

hamda

$$y = c, \quad y = d$$

chiziqlar bilan chegaralangan D_2 to'pamni olaylik, bunda $x_1(y)$, $x_2(y)$ funksiyalar $[c, d]$ da uzluksiz (53- chizma).

Ravshanki, D_2 ning chegarasi (konturi) ∂D_2 quyidagi I, II, III, IV chiziq'larga ajraladi (bunda II va IV chiziq'larga aylinishi mumkin).

Faraz qilaylik, $\overline{D_2} = D_2 \cup \partial D_2$ da $Q(x, y)$ funksiya uzluksiz bo'lib, u uzluksiz $\frac{\partial Q(x, y)}{\partial y}$ xususiy hosilaga ega bo'lsin. Ushbu

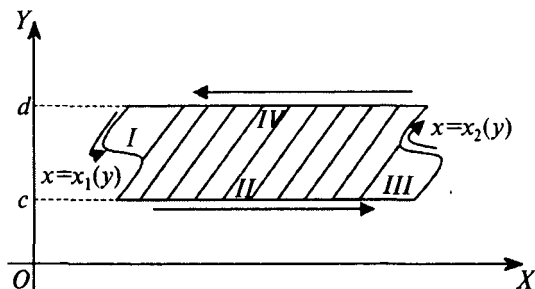

53- chizma.

$$\int_{\partial G_2} Q(x, y) dy$$

egri chiziqli integralni qaraymiz. Uni quyidagicha

$$\int_{\partial G_2} Q(x, y) dy = \int_I Q(x, y) dy + \int_{II} Q(x, y) dy + \int_{III} Q(x, y) dy + \int_{IV} Q(x, y) dy$$

ko'rinishda yozib olamiz. II va IV chiziqlar OY o'qqa perpendikular bo'lganligi sababli

$$\int_{II} Q(x, y) dy = \int_{IV} Q(x, y) dy = 0$$

bo'lib,
$$\int_{\partial G_2} Q(x, y) dy = \int_I Q(x, y) dy + \int_{III} Q(x, y) dy$$

ga ega bo'lamiz. Endi

$$\begin{aligned} \int_I Q(x, y) dy + \int_{III} Q(x, y) dy &= \int_c^d Q(x_1(y), y) dy + \\ &+ \int_c^d Q(x_2(y), y) dy = \int_c^d [Q(x_1, y) - Q(x_2, y)] dy = \\ &= \int_c^d Q(x, y) \Big|_{x=x_1}^{x=x_2} dy = \int_c^d \left[\frac{\partial Q(x, y)}{\partial x} dx \right] dy = \iint_{D_2} \frac{\partial Q(x, y)}{\partial x} dx dy \end{aligned}$$

bo'lishini e'tiborga olib topamiz:

$$\int_{\partial G_2} Q(x, y) dy = \iint_{D_2} \frac{\partial Q(x, y)}{\partial x} dx dy. \quad (2)$$

Aytmalik, tekislikdagi F to'plam shunday bo'lsaki, uni gorizontal chiziqlar yordamida yuqoridagi D_2 kabi F_k ($k=1, 2, 3, \dots$) larga ajratish mumkin bo'lsin (54- chizma).

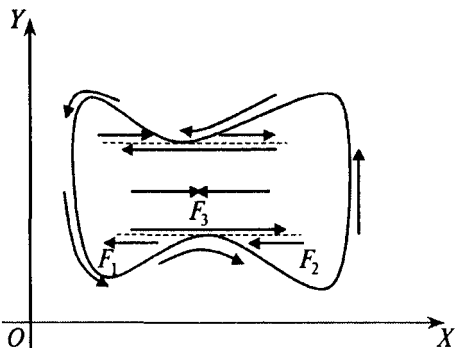

54- chizma.

Bunday to'plam uchun ham (2) formula o'rinli bo'ladi:

$$\int_{\partial F} Q(x, y) dy = \sum_{k=1}^n \oint_{\partial F_k} Q(x, y) dy = \sum_{k=1}^n \left(\iint_{F_k} \frac{\partial Q(x, y)}{\partial x} dx dy \right) = \iint_G \frac{\partial Q(x, y)}{\partial x} dx dy.$$

Faraz qilaylik, tekislikdagi D to'plam yuqoridagi D_1 va D_2 lar xususiyatiga ega bo'lib, unda $P(x, y)$, $Q(x, y)$ funksiyalar uzluksiz va uzluksiz $\frac{\partial P(x, y)}{\partial y}$, $\frac{\partial Q(x, y)}{\partial x}$ xususiy hosilalarga ega bo'lsin. U holda $P(x, y)$ va $Q(x, y)$ funksiyalar uchun bir yo'la (1) va (2) formulalar o'rinli bo'ladi. Ularni hadlab qo'shib topamiz:

$$\int_{\partial D} P(x, y) dx + Q(x, y) dy = \iint_D \left(\frac{\partial Q(x, y)}{\partial x} - \frac{\partial P(x, y)}{\partial y} \right) dx dy. \quad (3)$$

Bu *Grin formulasi* deyiladi. Demak, Grin formulasi to'plam bo'yicha olingan ikki karrali integral bilan shu to'plam chegarasi bo'yicha olingan egri chiziqli integralning bog'lanishini ifodalaydi.

2°. Grin formulasining ba'zi bir tatbiqlari. Aytmalik, yuqorida keltirilgan bir bog'lamli D to'plamda $P(x, y)$, $Q(x, y)$ funksiyalar uzluksiz va uzluksiz xususiy hosilalarga ega bo'lsin. U holda Grin formulasi (3) o'rinli bo'ladi.

Grin formulasidan foydalanib, tekis shakl yuzining egri chiziqli integral yordamida ifodalanishini ko'rsatish mumkin.

Aytmalik, $P^*(x, y)$, $Q^*(x, y)$ funksiyalar D to'plamda yuqorida keltirilgan shartlarni qanoatlantirishi bilan birga ushbu

$$\frac{\partial Q^*(x, y)}{\partial x} - \frac{\partial P^*(x, y)}{\partial y} \equiv 1$$

shartni ham qanoatlantirsin. U holda

$$\iint_D \left(\frac{\partial Q^*(x,y)}{\partial x} - \frac{\partial P^*(x,y)}{\partial y} \right) dx dy = \mu D$$

bo'lib, Grin formulasiga ko'ra

$$\mu D = \int_{\partial D} P^*(x,y) dx + Q^*(x,y) dy$$

bo'ladi. Xususan, $P^*(x,y) = -y$, $Q(x,y) = 0$ yoki

$P^*(x,y) = 0$, $Q(x,y) = 0$, yoki $P^*(x,y) = -\frac{1}{2}y$, $Q(x,y) = \frac{1}{2}x$
bo'lsa,

$$\frac{\partial Q^*(x,y)}{\partial x} - \frac{\partial P^*(x,y)}{\partial y} \equiv 1$$

bo'lib, to'planning yuzi quyidagiga teng bo'ladi:

$$\mu D = -\oint_{\partial D} y dx = \oint_{\partial D} x dy = \frac{1}{2} \oint_{\partial D} x dy - y dx. \quad (4)$$

Mashqlar

1. Grin formulasidan foydalanib, ushbu

$$\int_L \sqrt{x^2 + y^2} dx + y \left[xy + \ln \left(x + \sqrt{x^2 + y^2} \right) \right] dy$$

egri chiziqli integral hisoblansin.

2. Ushbu

$$\begin{cases} x = a \cos^3 t, \\ y = a \sin^3 t, \end{cases} \quad (0 \leq t \leq 2\pi)$$

astroida bilan chegaralangan to'planning yuzi topilsin.

Adabiyotlar

1. *Azlarov T., Mansurov H.* Matematik analiz. 1-tom. Toshkent, «O'zbekiston», 1994, 1995.
 2. *Xudayberganov G., Varisov A., Mansurov H.* Matematik analiz. 1- va 2-qismlar. Qarshi, «Nasaf», 2003.
 3. *Архипов Г., Садовничий Е., Чубариков В.* Лекции по математическому анализу. Москва, «Высшая школа», 1999.
 4. *Ильин В., Садовничий В., Сендов Б.* Математический анализ, Москва «Наука», 1979.
 5. *Кудрявцев Л.* Курс математического анализа. Т. 1. 1973.
 6. *Рудин У.* Основы математического анализа. Москва, «Мир», 1976.
 7. *Дороговцев А.* Математический анализ. Киев, «Высшая школа», 1985.
 8. *Фихтсгольц Г.* Курс дифференциального и интегрального исчисления. Т. I, II. Москва, «Физмат-лит», 2001.
 9. *Sa'dullayev A., Mansurov H., Xudayberganov G., Varisov A., G'ulomov R.* Matematik analiz kursidan misol va masalalar to'plami. 1- va 2- tomlar. Toshkent, «O'zbekiston», 1993, 1996.
 10. *Демидович Б.* Сборник задач и упражнений по математическому анализу. Москва, «Наука», 1990.
-

MUNDARIJA

Soʻz boshi

11- bob. Sonli qatorlar (davomi)

- 53- ma'ruza. Ixtiyoriy hadli qatorlarda yaqinlashish alomatlari 4
54- ma'ruza. Cheksiz ko'paytmalar 9

12- bob. Ko'p o'zgaruvchili funksiyalar, ularning limiti, uzluksizligi

- 55- ma'ruza. R^m fazo. R^m fazoda ochiq va yopiq to'plamlar 16
56- ma'ruza. R^m fazoda ketma-ketlik va uning limiti 25
57- ma'ruza. Ko'p o'zgaruvchili funksiya va uning limiti 33
58- ma'ruza. Ko'p o'zgaruvchili funksiyaning uzluksizligi.
Tekis uzluksizlik. Kantor teoremasi 46

13- bob. Ko'p o'zgaruvchili funksiyaning hosila va differensiallari

- 59- ma'ruza. Ko'p o'zgaruvchili funksiyaning xususiy hosilalari. Funksiyaning differensiallanuvchanligi 59
60- ma'ruza. O' rta qiymat haqida teorema. Yo'nalish bo'yicha hosila 72
61- ma'ruza. Ko'p o'zgaruvchili funksiyaning differensial 80
62- ma'ruza. Ko'p o'zgaruvchili funksiyaning yuqori tartibli hosila va differensiallari. Teylor formulasi 88
63- ma'ruza. Ko'p o'zgaruvchili funksiyaning ekstremumlari 99
64- ma'ruza. Oshkormas funksiyalar 109

14- bob. Funksional ketma-ketlik va qatorlar

- 65- ma'ruza. Funksional ketma-ketliklar va ularning tekis yaqinlashuvchanligi 119
66- ma'ruza. Funksional qatorlar va ularning tekis yaqinlashuvchanligi 130
67- ma'ruza. Tekis yaqinlashuvchi funksional qatorlarning xossalari 140
68- ma'ruza. Darajali qatorlar, ularning yaqinlashish radiusi va yaqinlashish intervallari 148

69- ma'ruza.	Darajali qatorning tekis yaqinlashishi. Darajali qatorning xossalari	157
70- ma'ruza.	Taylor qatori	163
71- ma'ruza.	Uzluksiz funksiyani ko'phad bilan yaqinlashtirish. Veyershtass teoremasi	172
72- ma'ruza.	Furye qatori tushunchasi	179
73- ma'ruza.	Furye qatorining yaqinlashuvchanligi	190

15- bob. Parametrga bog'liq integrallar

74- ma'ruza.	Ikki o'zgaruvchili funksiyaning bir o'zgaruvchisi bo'yicha yaqinlashishi	202
75- ma'ruza.	Parametrga bog'liq integrallar	209
76- ma'ruza.	Chegaralari o'zgaruvchi parametrga bog'liq integrallar	216
77- ma'ruza.	Parametrga bog'liq xosmas integrallar	222
78- ma'ruza.	Parametrga bog'liq xosmas integrallarning funktional xossalari	231
79- ma'ruza.	Ba'zi xosmas integrallarni hisoblash	240
80- ma'ruza.	Eyler integrallari	247

16- bob. Karrali integrallar

81- ma'ruza.	Tekis shaklning yuzi hamda fazodagi jismning hajmi haqida ba'zi ma'lumotlar	260
82- ma'ruza.	Ikki karrali integral tushunchasi va uning mavjudligi	267
83- ma'ruza.	Integrallanuvchi funksiyalar sinfi. Integralning asosiy xossalari	274
84- ma'ruza.	Ikki karrali integralni hisoblash	280
85- ma'ruza.	Ikki karrali integralda o'zgaruvchilarni almashtirish ...	291
86- ma'ruza.	Ikki karrali integralning ba'zi bir tatbiqlari	298
87- ma'ruza.	Uch karrali integrallar	305

17- bob. Egri chizikli integrallar

88- ma'ruza.	Egri chiziqlar va ularning uzunliklari haqida	315
89- ma'ruza.	Birinchi tur egri chizikli integrallar	323
90- ma'ruza.	Ikkinchi tur egri chizikli integrallar	331
91- ma'ruza.	Grin formulasi va uning tatbiqlari	343

Adabiyotlar	349
-------------------	-----

Matematik analizdan ma'ruzalar / G. Xudayberganov va boshq.;
taqrizchilar: R.R. Ashurov, R.N. G'anixo'jayev; O'zbekiston Respub-
likasi Oliy va o'rta-maxsus ta'lim vazirligi. — T.: «Voris-nashriyot»,
2010. — 352 b.

I. Xudayberganov G.

ББК22.1я73

*G. Xudayberganov, A.K. Vorisov,
X.T. Mansurov, B.A. Shoimqulov*

MATEMATIK ANALIZDAN MA'RUZALAR

II

*5460100—«Matematika», 5440200—«Mexanika» bakalavr
yo'nalishidagi talabalar uchun o'quv qo'llanma*

*«Voris-nashriyot» MChJ
Toshkent — 2010*

Muharrir *M.Shermatova*
Badiiy muharrir *B. Ibrohimov*
Sahifalovchi *Sh.Rahimqoriyev*

Original-maketdan bosishga 23.11.2010 da ruxsat etildi.
Bichimi 60×84¹/₁₆. Ofset bosma usulida bosildi. Bosma t. 22,0.
Shartli b.t. 19,0. Adadi 500. Buyurtma № *77*

«Voris-nashriyot» MChJ, Toshkent, Shiroq ko'chasi, 100.

MChJ «Noshir» O'zbekiston-Germaniya qo'shma korxonasining
bosmaxonasida chop etildi.

Toshkent sh., Navoiy ko'chasi, pastki savdo rastalari

«Voris-nashriyot»

ISBN 978-9943-375-31-4



9 789943 375314